

## ALLGEMEIN CHIRURGIE GENERAL SURGERY



Der Ihnen vorliegende Gesamtkatalog bleibt Eigentum der AMNOTEC International Medical GmbH. Dies gilt auch dann, wenn eine Leih- oder Schutzgebühr für diesen Katalog entrichtet wurde. Er darf ausschließlich zum Zweck des Einkaufs und Vertriebs der darin beschriebenen AMNOTEC-Produkte durch den hierzu autorisierten Fachhandel oder zur Bedarfsbeschaffung durch den entsprechenden Anwender benutzt werden. Die Verwendung des Katalogs entgegen unseren Interessen berechtigt uns zur unverzüglichen Rückforderung und optionalen weiteren Maßnahmen. Dieser Katalog darf weder teilweise noch im Gesamten kopiert, digital eingesehen oder nachgedruckt werden, sofern nicht unsere ausdrückliche, schriftliche Genehmigung vorliegt.

The general catalogue remains the property of AMNOTEC International Medical GmbH. This also applies if a lending fee or nominal charge has been paid for this catalog. It may only be used for the purpose of purchasing and selling the AMNOTEC products described therein by the specialized trade authorized in this regard, or for supplying the needs of the respective user. The use of the catalog against our interests entitles us to demand that the catalog be returned immediately, as well as other possible actions. This catalog may not be copied in part or in whole, be digitally scanned or printed from a scan without our express, written consent.

El catálogo global de que tiene en su poder es propiedad de AMNOTEC International Medical GmbH. Esto también se aplica incluso en el caso de que haya pagado las tasas de préstamo o protección de dicho catálogo. Por lo tanto, sólo puede utilizarse para comprar y comercializar los productos de AMNOTEC que se describen en su interior a través de un establecimiento especializado autorizado, o bien para la adquisición por parte del usuario correspondiente de los productos que necesite. Si el catálogo se utiliza en contra de nuestros intereses, tendremos derecho a que éste se nos devuelva de inmediato, o bien a tomar las medidas que consideremos oportunas. Queda prohibida la reproducción total o parcial de este catálogo, así como su procesamiento digital o su reimpresión, sin nuestro consentimiento expreso y por escrito.

Il catalogo generale in vostro possesso rimane di proprietà di AMNOTEC International Medical GmbH. Ciò vale anche nel caso in cui per questo catalogo sia stato versato un contributo per prestito o spese. Il catalogo deve essere utilizzato esclusivamente per l'acquisto e la distribuzione dei prodotti AMNOTEC descritti nello stesso da parte del personale specializzato e autorizzato oppure per il necessario approvvigionamento da parte dei rispettivi utilizzatori. L'utilizzo del catalogo a scapito dei nostri interessi ci autorizza a richiederne l'immediata restituzione e a perseguire eventuali ulteriori misure. Questo catalogo non deve essere fotocopiato, riprodotto con mezzi digitali o ristampato, né parzialmente né integralmente, senza la nostra espressa autorizzazione scritta.

Modelländerungen vorbehalten  
Patterns are subject to change

02/2021 © AMNOTEC International Medical GmbH | All rights reserved | printed in Germany





"Medizintechnik aus Tuttlingen" – dieser Begriff steht für hochwertigste Produkte sowie für Dynamik und Fortschritt auf dem Gebiet der Medizintechnologie und der Minimalinvasiven Chirurgie. Im Weltzentrum der Medizintechnik Tuttlingen, Germany gehört AMNOTEC International Medical GmbH, mit mehreren Jahrzehnten Erfahrung, zu einem der führenden und ambitionierten Medizinproduktehersteller und -anbieter.

Das breite Portfolio umfasst eine einzigartige Vielfalt medizinischer Produkte. Ein weiterer wichtiger Bestandteil des AMNOTEC-Leistungsspektrums ist das Angebot neuester Technologien.

AMNOTEC hat sich als effizienter Komplettanbieter auf die Ausstattung von Operationssälen spezialisiert. Das fundierte Fachwissen des gesamten AMNOTEC-Teams sowie die hochwertige Qualität der Produkte, die Flexibilität und ein exzellenter Kundenservice sind die Eckpfeiler des Unternehmens.

The concept "Medical Technology from Tuttlingen" stands for surgical and medical-engineering Instruments and Devices of highest quality as well as for dynamic and progress. Located at the world centre for Medical Technology in Tuttlingen / Germany, AMNOTEC with several decades of experience is one of the leading ambitious medical device manufacturers and suppliers.

The wide product portfolio includes an unique variety of medical products. An important element of AMNOTEC range of services is providing state-of-the-art technologies.

AMNOTEC has specialised as an efficient full-service provider for the equipment of operating room. The established expertise of the entire AMNOTEC team in addition to the premium quality of the products, flexibility and an excellent customer service are the corner-stones of the company.



Material  
Materials  
Material  
Materiale

Ausführung  
Specification  
Especificación  
Specifica



Titan | Titanium  
Titanio | Titanio



Supercut | Supercut  
Supercut | Supercut



Aluminium | Aluminium  
Aluminio | Aluminio



Supercut Titan-Nitrit | Supercut Titanium-Nitrite  
Supercut Nitrito de Titanio | Nitrito di Titanio



Kunststoff | Plastic  
Plastico | Plastica



Hartmetalleinlagen | Tungsten Carbide inserts  
Carburo de tungsteno | Carburo di tungsteno



Keramikbeschichtung | Ceramic coating  
Superficie cerámica | Superficie alla ceramica



Diamantbeschichtet | Diamond dusted  
Recubrimiento de diamante | Rivestimento di diamante



Silber | Silver  
Plata | Argento



Wellenschliff | Wave Cut  
Corte de la onda | Taglio dell'onda



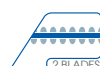
Verchromt | Chrome plated  
Cromado | Cromato



1 Schneide gezahnt | 1 serrated blade  
1 hoja dentada | 1 lama dentata



Schwarz verchromt | Black Chrome plated  
Cromado negro | Cromato nero



2 Schneiden gezahnt | 2 serrated blades  
2 hojas dentadas | 2 lame dentate



Edelstahl | Stainless Steel  
Acero | Acciaio inossidabile



Streamline Verschluss | Streamline box lock  
Cerradura de la caja | Serratura della scatola



Neusilber | German silver  
Plata alemaña | Alpaca



mit Gegengewicht | with counterbalance  
con contrabalanza | con contrappeso



Teflon® | Teflon®  
Teflon® | Teflon®

**Atraumatisch | Atraumatic**  
**Atraumáticas | Atraumatiche**



Nylon | Nylon  
Nilón | Nylon



De Bakey, 1 Reihe | De Bakey, 1 serration  
De Bakey, 1 dentada | De Bakey, 1 dentata



Ferrozell | Ferrozell  
Ferrozell | Ferrozell



De Bakey, 2 Reihen | De Bakey, 2 serrations  
De Bakey, 2 dentadas | De Bakey, 2 dentate



Propylux® | Propylux®  
Propylux® | Propylux®



Cooley, 1 Reihe | Cooley, 1 serration  
Cooley, 1 dentada | Cooley, 1 dentata



Peek | Peek  
Peek | Peek



Cooley, 2 Reihen | Cooley, 2 serrations  
Cooley, 2 dentadas | Cooley, 2 dentate



Artikel-Nummer  
 Item number  
 No del artículo  
 Code articolo

Jede Zeichnung und/oder Produktabbildung in diesem Katalog hat nur eine Artikelnummer und wird auch nur einmal abgebildet.

Every drawing and/or image in this catalogue has its unique item number and is pictured just once.

Al lado del dibujo y/o la ilustración del producto. Cada producto tiene sólo un número y aparece solamente una vez en el catálogo.

Al lado del dibujo y/o la ilustración del producto. Cada producto tiene sólo un número y aparece solamente una vez en el catálogo.

**Nummernschlüssel:**

**Number code:**

**Clave del número:**

**Chiave del codice:**

**12 - 201 - 14**

**12 - 201 - 14**

**12 - 201 - 14**

**12 - 201 - 14**

Artikelgruppe  
 Laufende Nr. innerhalb der Gruppe  
 Größe/Figur des Instruments

Product group  
 Consecutive number within the group  
 Size/shape of the instrument

Grupo de artículos  
 Número corrido dentro del grupo  
 Tamaño/forma del instrumento

Gruppo di articoli  
 Numero progressivo all'interno del gruppo  
 Dimensioni/forma dello strumento

**12-201-18 W**

**METZENBAUM**

**12-201-18** 18,0 cm, 7 " .....









Arbeitsende des Produkts  
 Working end of the product  
 El extremo funcional del producto se muestra  
 Risultato finale di lavorazione del prodotto

Optional: Ausführung  
 Optional: Specification  
 Opcional: Especificación  
 Opzione: Specifica





Autor (wenn vorhanden)  
 Author (if available)  
 Autor (si ho lay)  
 Autore (se disponibile)

Maße  
 Dimensions  
 Dimensiones  
 Dimensioni









Artikel-Nummer  
 Item number  
 No del artículo  
 Codice articolo

Artikelgruppe Product group Grupo de artículos Gruppo di articoli		Kapitel Chapter Capítulo Capitolo	Seite Page Página Pagina
	Diagnostik Diagnostics Diagnóstico Diagnostica	<b>10</b>	15 - 90
	Scheren Scissors Tijeras Forbici	<b>11</b>	91 - 148
	SUPER CUT Scheren SUPER CUT scissors Tijeras SUPER CUT Forbici SUPER CUT	<b>11 SC</b>	149-158
	Scheren mit Hartmetallschneiden Scissors with tungsten carbide edges Tijeras con filos de carburo tungsteno Forbici con lame in carburo i tungsteno	<b>12</b>	159-182
	SUPER CUT TITAN-NITRIT Scheren SUPER CUT TITANIUM-NITRIT scissors Tijeras SUPER CUT NITRITO de TITANIO Forbici SUPER CUT NITRITO di TITANIO	<b>12 SCT</b>	183-192
	Pinzetten Forceps Pinzas Pinze	<b>13</b>	193-230
	Pinzetten mit Hartmetalleinlagen Forceps with tungsten carbide inserts Pinzas con bocas de carburo tungsteno Pinze con morsi in carburo di tungsteno	<b>14</b>	231-236
	Arterienklemmen Artery forceps, Haemostatic forceps Pinzas haemostaticas Pinze emostatiche	<b>15</b>	237-372











Artikelgruppe Product group Grupo de artículos Gruppo di articoli		Kapitel Chapter Capítulo Capitolo	Seite Page Página Pagina
	Wundhaken Retractors Separadores Divaricatori	<b>16</b>	373-486
	Nadelhalter Needle holders Porta-agujas Portaghi	<b>17</b>	487-518
	Nadelhalter mit Hartmetalleinlagen Needle holders with tungsten carbide inserts Porta-agujas con bocas de carburo tungsteno Portaghi con morsi in carburo di tungsteno	<b>18</b>	519-536
	Neurochirurgie Neurosurgery Neurocirugía Neurochirurgia	<b>20</b>	537-594
	HNO-Instrumente ENT Instruments Instrumentos para ORL Strumenti per ORL	<b>26</b>	595-708
	HNO-Instrumente ENT Instruments Instrumentos para ORL Strumenti per ORL	<b>27</b>	709-762
	Thorax, Lunge Thorax, Lung Thorácio, Pulmòn Thorace, Polmone	<b>30</b>	763-802
	Herz- und Gefäßschirurgie Cardiovascular Surgery Cirugía cardiovascular Chirurgia cardiovascolare	<b>31</b>	803-842



Artikelgruppe Product group Grupo de artículos Gruppo di articoli		Kapitel Chapter Capítulo Capitolo	Seite Page Página Pagina
	Magen, Darm, Rektum Stomach, Intestines, Rectum Estómago, Intestino, Recto Stomaco, Intestino, Retto	33	843-870
	Leber, Galle, Niere Liver, Gall bladder, Kidney Hígado, Bilis, Riñón Fegato, Biliari, Renali	34	871-878
	Gynäkologie, Geburtshilfe Gynaecology, Obstetrics Ginecologia, Obstetricia Ginecologia, Ostetricia	35	879-942
	Urologie Urology Urologia Urologia	36	943-956
	Knochenchirurgie Bone Surgery Cirugía ósea Chirurgia ossea	40	957-1174
	Osteosynthese Osteosynthesis Osteosíntesis Osteosintesi	42-44	
	Hand- und Fuß Chirurgie Hand and foot Surgery Cirugía de mano y pie Chirurgia della mano e piede	47	1175-1184
	Gips- und Verbandinstrumente Plaster and Dressing Instruments Instrumentos para vendajes y yeso Strumenti per bendaggi e gessature	48	1185-1200



Artikelgruppe Product group Grupo de artículos Gruppo di articoli		Kapitel Chapter Capítulo Capitolo	Seite Page Página Pagina
	Arthroskopie Instrumente Arthroscopy Instruments Instrumentos para Artroscopia Strumenti per Artroscopia	<b>49</b>	
	Stationsinstrumente Ward Instruments Instrumentos para enfermería Strumenti per medicazione	<b>50</b>	1201-1210
	Behälter, Gefäße Stainless Steel Holloware Recipientes Recipienti	<b>51</b>	1211-1218
	Container Systeme Container Systems Sistema de Contenedores Sistema di Contenitori	<b>55</b>	
	Sterilisation Sterilization Esterilización Sterilizzazione	<b>56</b>	1219-1228
	Motorensysteme Motor Systems Sistema de motor Sistema di motore	<b>60</b>	
	Arthroskopie Instrumente Arthroscopy Instruments Instrumentos para Artroscopia Strumenti per Artroscopia	<b>65</b>	
	Hochfrequenz Chirurgie High Frequency Surgery Cirugía de alta frecuencia Chirurgia ad alta frequenza	<b>70</b>	











SURGERY



General Surgery



Dental Instruments



ENT Instruments



Sterilization Container



Micro Surgery



Electrosurgery

ENDOSCOPY



Endoscopic Devices



Endoscopes



Laparoscopy



Endoscopic Urology



Endoscopic Gynaecology



Arthroscopy

OR-EQUIPMENT



Operating Lights



Examination Lights



Operating Tables



Accessories for OR-Tables



Intensive Care Unit Beds



Head Rest System



# 10

Diagnostik  
Diagnostics  
Diagnóstico  
Diagnostica





mit Nadel  
with needle  
con aguja  
con ago

**BUCK**

**10-000-18** 18,0 cm, 7 "



**DEJERINE**

**10-001-20** 20,0 cm, 8 "



mit Nadel  
with needle  
con aguja  
con ago

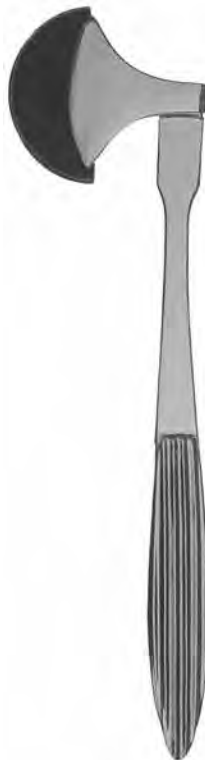
**DEJERINE**

**10-002-21** 20,0 cm, 8 "



**TAYLOR**

**10-003-17** 17,0 cm, 6 ¾ "  
**10-003-20** 20,0 cm, 8 "



**BERLINER**

**10-004-17** 17,0 cm, 6 ¾ "  
**10-004-20** 20,0 cm, 8 "



**TROEMMER**

**10-005-24** 24,0 cm, 9 ½ "



### RABINER

**10-006-23** 23,0 cm, 9 "



mit Nadel  
with needle  
con aguja  
con ago

Kopf umsteckbar  
Reversible head  
Cabeza reversible  
Testa pieghevole

### BABINSKY

**10-007-22** 22,0 cm, 8  $\frac{3}{4}$  "



### TRAUBE

**10-008-16** 16,0 cm, 6  $\frac{1}{4}$  "



Holz  
Wood  
Madera  
Legno

### PINARD

**10-010-01** 18,0 cm, 7 "



AL  
ALUMINIUM

### PINARD

**10-010-02** 15,0 cm, 6 "





AL  
ALUMINIUM

**BOWLES**

**10-011-00** Ø 40,0 mm



AL  
ALUMINIUM

für Erwachsene  
for adults  
para adultos  
per adulti

**DUPLEX**

**10-012-01** Ø 47,0 mm



AL  
ALUMINIUM

für Kinder  
for children  
para niños  
per bambini

**DUPLEX**

**10-012-02** Ø 37,0 mm



AL  
ALUMINIUM

für Säuglinge  
for infants  
para niños pequeños  
per neonati

**DUPLEX**

**10-012-03** Ø 22,0 mm



AL  
ALUMINIUM

### RI-RAP

**10-012-40** 40,0 cm, 15  $\frac{3}{4}$ "



AL  
ALUMINIUM

### RI-RAP

**10-012-80** 80,0 cm, 31  $\frac{1}{2}$ "



AL  
ALUMINIUM

### ANESTOPHONE

**10-013-00** Ø 48,0 mm



AL  
ALUMINIUM

### CARDIOPHONE

**10-014-00** Ø 36 | 48 mm

Algesimeter mit Nadel und Pinsel  
Algesimeter with needle and brush  
Algesímetro con aguja y cepillo  
Algesiometro con ago e pennello



**ALY**

**10-014-19** 19,0 cm, 7 1/2"

Algesimeter (Nervrädchen)  
Algesimeter (pinwheel)  
Algesímetro (rueda con espinas)  
Algesiometro (rotella neurologica)



**WARTENBERG**

**10-015-18** 18,5 cm, 7 1/4"

Ästhesiometer  
Aesthesiometer  
Estesiometro  
Estesiometro



**WEBER**

**10-016-09** 9,5 cm, 3 3/4"

Meßbereich: 180°  
Measuring range: 180°  
Alcance de medición: 180°  
Campo di misura: 180°

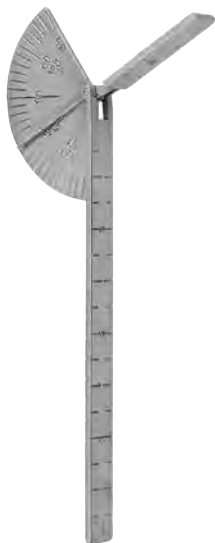


Winkelmesser  
Flexometer  
Goniómetro  
Goniometro

**MOELTGEN**

**10-021-01** 23,0 cm, 9"

Finger-Goniometer  
Finger goniometer  
Goniómetro para dedos  
Goniometro per le dita



**CAROLL**

**10-021-02** 14,5 cm, 5 3/4"

Meßbereich: 250 mm  
Measuring range: 250 mm  
Alcance de medición: 250 mm  
Campo di misura: 250 mm



**BERTILLON**

**10-023-32** 32,0 cm, 12 1/2"

Dynamometer für Erwachsene  
Dynamometer for adults  
Dinamómetro para adultos  
Dinamometro per adulti



**COLLIN**

**10-024-01** 12,5 cm, 5"

Dynamometer für Kinder  
Dynamometer for children  
Dinamómetro para niños  
Dinamometro per bambini



**COLLIN**

**10-024-02** 12,5 cm, 5"



Maßband, Stahl  
 Measuring tape, steel  
 Cinta métrica, acero  
 Metro a nastro metallico

Maßband, Wachstuch  
 Measuring tape, wax cloth  
 Cinta métrica, tela encerada  
 Metro a nastro in tela cerata

Graduiert in cm und Zoll  
 Graduated in cm and inches  
 Graduado en cm y pulgadas  
 Graduate in e pollici

Mamillenringe, stumpf  
 Areola marker, blunt  
 Marcadores para areóla, romo  
 Marcatori per areola, smusso



Mamillenringe, scharf  
 Areola marker, sharp  
 Marcadores para areóla, agudo  
 Marcatori per areola, acuto



- 10-024-32** Ø 32,0 mm
- 10-024-37** Ø 37,0 mm
- 10-024-43** Ø 43,0 mm
- 10-024-50** Ø 50,0 mm

- 10-025-32** Ø 32,0 mm
- 10-025-37** Ø 37,0 mm
- 10-025-43** Ø 43,0 mm
- 10-025-50** Ø 50,0 mm

**10-030-15** 150 cm, 59 "

**10-031-15** 150 cm, 59 "

Komplett  
 Complete  
 Completo  
 Completo



**10-026-05**

3 Ersatzgummibälle  
 3 spare rubber bulbs  
 3 peras de goma  
 3 Palloni di ricambio

**10-026-98**

Ersatzschlauch  
 spare tube  
 tubo de repuesto  
 tubo di ricambio

**10-026-99**

Manometer, allein  
 manometer, only  
 manómetro, suelto  
 manometro, solo

**VIGORIMETER**

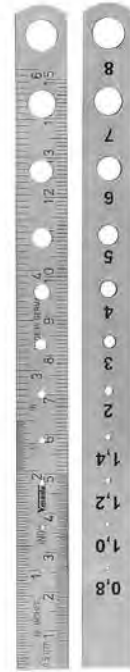
**10-026-00**



Messstab, graduert in cm und Zoll  
Ruler, graduated in cm and inches  
Regla, graduado en cm y pulgadas  
Misuratori, graduate in e pollici



Röntgen Messstab  
Ruler, X-Ray  
Regla para rayos X  
Misuratore per raggi X



mit Lochlehre  
with hole gauge  
con calibre de agujeros  
calibro forato

- 10-032-10** 100 mm

---

- 10-032-15** 150 mm

---

- 10-032-20** 200 mm

---

- 10-032-30** 300 mm

---

- 10-032-50** 500 mm

**10-033-50** 500 mm

**10-034-15** 150 mm



**TOWNLEY**

**10-036-11** 100 mm



**10-036-15** 150 mm



**JAMESON**

**10-036-81** 80 mm





Vergrößerung x 2,5  
Magnifying power x 2.5  
Aumento x 2,5  
Ingrandimento x 2,5



**10-037-50** Ø 50 mm

Vergrößerung x 2,5  
Magnifying power x 2.5  
Aumento x 2,5  
Ingrandimento x 2,5



**10-037-75** Ø 75 mm

Tonometer, komplett, fabrikgeeicht  
Tonometer, complete, calibrated by the manufacturer  
Tonómetro, completo, constastado por la fábrica  
Tonometro, completo, verificato dalla fabbrica



**10-038-00**

Skala schräg  
Scale oblique  
Escala oblicua  
Scala obliqua

**10-038-01**

Skala gerade  
Scale straight  
Escala recta  
Scala retta

**SCHIOETZ**

**10-038-00 - 10-038-01**

mit Klettenmanschette  
with velcro cuff  
con brazalete de velcro  
con bracciale velcro

Messbereich 0 - 300 Hg  
Measuring range 0 - 300 Hg  
Alcance de medición 0 - 300 Hg  
Misurare fino a 0 - 300 Hg



**PRECISA**  
10-039-01

mit Klettenmanschette  
with velcro cuff  
con brazalete de velcro  
con bracciale velcro

Messbereich 0 - 300 Hg  
Measuring range 0 - 300 Hg  
Alcance de medición 0 - 300 Hg  
Misurare fino a 0 - 300 Hg



**MAXIMUS**  
10-040-00

mit Klettenmanschette  
with velcro cuff  
con brazalete de velcro  
con bracciale velcro

Messbereich 0 - 300 Hg  
Measuring range 0 - 300 Hg  
Alcance de medición 0 - 300 Hg  
Misurare fino a 0 - 300 Hg



**MINIMUS**  
10-040-01

mit Klettenmanschette  
with velcro cuff  
con brazalete de velcro  
con bracciale velcro

Messbereich 0 - 300 Hg  
Measuring range 0 - 300 Hg  
Alcance de medición 0 - 300 Hg  
Misurare fino a 0 - 300 Hg



**PACHON**  
10-040-02



mit Klettenmanschette, Quecksilberröhre 300 mm  
with velcro cuff, mercury tube 300 mm  
avec manchette velcro, tube à mercure 300 mm  
con brazaletes de velcro, tubo de mercurio 300 mm

Messbereich 0 - 300 Hg  
Measuring range 0 - 300 Hg  
Alcance de medición 0 - 300 Hg  
Misurare fino a 0 - 300 Hg

## DIPLOMAT

10-041-00



mit Klettenmanschette, Quecksilberröhre 300 mm  
with velcro cuff, mercury tube 300 mm  
avec manchette velcro, tube à mercure 300 mm  
con brazaletes de velcro, tubo de mercurio 300 mm

Messbereich 0 - 300 Hg  
Measuring range 0 - 300 Hg  
Alcance de medición 0 - 300 Hg  
Misurare fino a 0 - 300 Hg

10-041-01



Komplett, mit Batterie  
Complete, with battery  
Completo, con pila  
Completo, con pila

**LED**

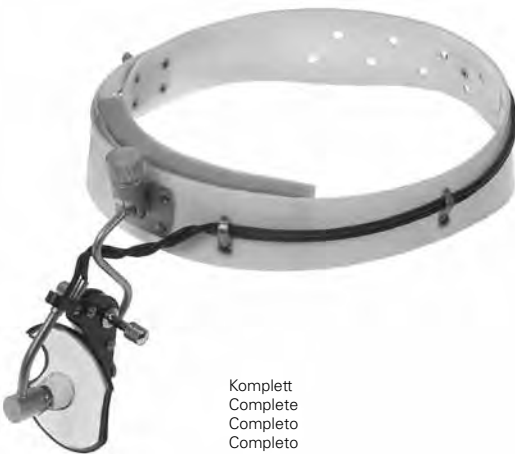
**10-042-00** 6V



Komplett  
Complete  
Completo  
Completo

**CLAR**

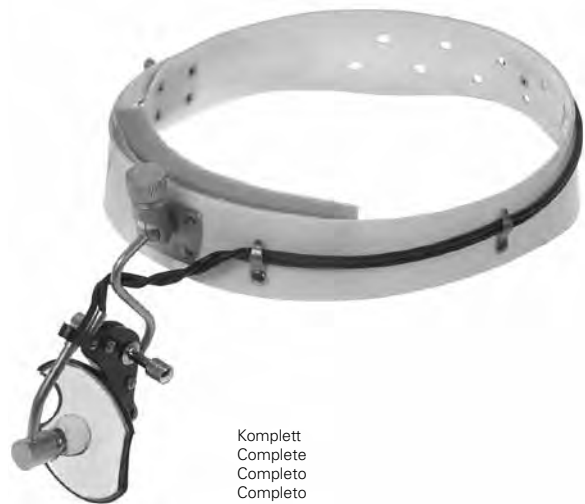
**10-042-01** Ø 100 mm | 6V



Komplett  
Complete  
Completo  
Completo

**CLAR**

**10-042-02** Ø 55 mm | 6V



Komplett  
Complete  
Completo  
Completo

**CLAR**

**10-042-03** Ø 98 mm | 6V



Komplett  
Complete  
Completo  
Completo

## JANSEN

**10-042-04** 6V



Mini-Transformator für 220 Volt Wechselstrom, mit Gummikabel und Steckbuchse für Schwachstrom, stufenlos regelbar 0-10 Volt.

Mini-transformer unit for 220 volts alternating current, with cable and outlet for low voltage current, infinitely variable from 0-10 volts.

Transformador eléctrico pequeño para 220 voltios corriente alterna, con cable y borne para corriente de baja tensión, regulador sin escalones desde 0-10 voltios.

Mini-transformatore elettrico, per 220 volt, corrente alternata a bassa tensione, regolazione continua da 0-10 volt.

**10-042-09** 0 - 10 V

**10-042-05** 6V

Ersatzbirne  
Spare bulb  
Bombilla de repuesto  
Lampadina di ricambio

**10-042-95**

Stirnband aus Celluloid, allein  
Head band of celluloid, only  
Cinta frontal de celuloide, suelto  
Fascia frontale di celuloide, solo

**10-042-96**

Ersatz-Schaumgummipolsterung  
Spare foam rubber pad  
Almohadillade goma-espuma  
Imbottitura frontale

**10-042-97** Ø 55 mm

Reflektorglas, ohne Fassung  
Reflector glass, without socket  
Reflector de cristal, sin montura  
Riflettore di cristallo, senza montatura

**10-042-98** Ø 55 mm

Reflektorglas, mit Fassung  
Reflector glass, with socket  
Reflector de cristal, con montura  
Riflettore di cristallo, con montatura

**10-042-99** Ø 100 mm

Reflektorgl, ohne Fassung  
Reflector glass, without socket  
Reflector de cristal, sin montura  
Riflettore di cristallo, senza montatura



## ULM CASE I

10-043-00

### ULM CASE I Komplett, bestehend aus:

- ULM CASE I mit 2 Ampullen-Streifen für je 13 Ampullen
- Aufkleber Atmung
- Sauerstoff-Gerät
- Gürtel für O2 Zylinder, 2 Stück
- Handbeatmungsbeutel für Erwachsene und Kinder
- Satz Beatmungsmasken, mit aufblasbarem Ventil, Silikon
- Satz Rendell-Baker Beatmungsmasken, Silikon
- Satz oropharyngeal Tubus (Guedel)
- Satz nasopharyngeal Tubus (Wendel)
- OMNIVAC Absaug-Apparat mit 250 ml Auffangbehälter, mit Düse
- Halter für OMNIVAC Beatmungsgerät
- Satz Absaugkatheter
- Laryngoskope, Metall, mit 2 McIntosh Zungendrucker (Grösse 1 und 2), mit Batterien
- Satz Trachealkanülen, Einmalgebrauch
- Satz medizinische Kleinteile
- Intubation Set

### ULM CASE I complete, consisting of:

- ULM CASE I with 2 ampoule strips for 13 ampoules each
- Set of Respiration labels
- Oxygen device
- Belts for O2 cylinders, 2 pcs.
- COMBIBAG Resuscitator for adults and children
- Set of ventilation masks, with inflatable mask, seal of silicone
- Set of Rendell-Baker ventilation masks, silicone
- Set of oropharyngeal tubes (Guedel)
- Set of nasopharyngeal tubes (Wendel)
- OMNIVAC suction equipment with 250 ml collection canister, with injector
- Holder for OMNIVAC aspiration equipment
- Set of suction catheters
- Laryngoscopes, metal, with 2 McIntosh tongue depressors (Sizes 1 and 2), with batteries
- Set of disposable tracheal tubes
- Set of small medical products
- Intubation set

### ULM CASE I completo, consta de

- Botiquín ULM CASE I con dos barras ampulario, cada una con capacidad para 13 ampollas
- Set de etiquetas para equipos respiratorios
- Botella de oxígeno
- Correas para la sujeción de una botella de oxígeno, 2 unidades
- Reanimador manual para adultos y pediátrico
- Set de máscaras respiratorias, con sellado inflable en silicona
- Set de máscaras respiratorias Rendell-Baker en silicona
- Set de cánulas orofaríngeas (Güedel)
- Set de cánulas nasofaríngeas (Wendel)
- Equipo de aspiración OMNIVAC con recipiente recolector de 250 ml, con inyector
- Soporte para el respirador OMNIVAC
- Set de sondas de aspiración
- Laringoscopio, metálico, con 2 sujetalenguas de McIntosh (tamaños 1 y 2), con baterías
- Set de cánulas traqueales, un solo uso
- Set de artículos sanitarios pequeños
- Set de intubación

### ULM CASE I completo, composta da:

- VALIGIA ULM I con 2 portafiale da 13 fiale ciascuna
- Adesivi farmaci respirazione
- Apparecchio per ossigeno
- Cinghiette per bombola di ossigeno, 2 pezzi
- Pallone per la respirazione manuale per adulti e bambini
- Set maschere per la respirazione con valvola gonfiabile, silicone
- Set maschere per la respirazione Rendell-Baker, silicone
- Set tubo orofaringeo (Güedel)
- Set tubo nasofaringeo (Wendel)
- Sistema di aspirazione OMNIVAC dotato di contenitore di raccolta da 250 ml e ugello
- Supporto per apparecchio per respirazione OMNIVAC
- Set catetere di aspirazione
- Laringoscopio, metallo, con 2 abbassalingua McIntosh (dimensione 1 e 2), con batterie
- Set cannule tracheali, monouso
- Set piccola strumentazione medica
- Set di intubazione



Komplett mit zwei Manschetten (10-045-01 | 10-045-02) und Pumpe, Messbereich 0 - 700 Hg  
 Complete with two cuffs (10-045-01 | 10-045-02) and pump, Measuring range 0 - 700 Hg  
 Completo con dos brazaletes (10-045-01 | 10-045-02) y bomba de aire, Alcance de medición 0 - 700 Hg  
 Completo con due bracciali (10-045-01 | 10-045-02) e pompa d'aria, Misurare fino a 0 - 700 Hg



**10-045-00**



**10-045-01** 57 x 9 cm

Oberarm-Manschette  
 Cuff for upper arm  
 Brazalete para el brazo  
 Bracciali per braccio

**10-045-02** 96 x 13 cm

Oberschenkel-Manschette  
 Cuff for thigh  
 Brazalete para el muslo  
 Bracciare per coscia

**10-045-03** 39 x 8 cm

Kinder-Manschette  
 Cuff for children  
 Brazalete para niños  
 Bracciare per bambini



**FRANCKE**

**10-046-00**



**10-047-00**

Staubinde, 5 m  
 Compression bandage, 5 m  
 Venda-compresión, 5 m  
 Fascia per ischemia, 5 m



**10-047-06** 6,0 cm, 2 1/3 "

**10-047-08** 8,0 cm, 3 "

**10-047-10** 10,0 cm, 4 "





## RI-SCOPE

10-048-00 2,5V



## RI-SCOPE

10-048-01 2,5V

### Opthalmoskopbesteck komplett in Etui, bestehend aus:

- 1 Batteriehandgriff (ohne Batterien)
- 1 Ophthalmoskop mit Halogenbirne, 2,5 V
- 1 Lupe, 5-fache Vergrößerung
- 1 Ersatzbirnchen, Halogen, 2,5 V

### Ophthalmoscope Set complete in case, consisting of:

- 1 Battery handle (without batteries)
- 1 Ophthalmoscope with halogen bulb, 2,5 V
- 1 Magnifying glass, 5 x
- 1 Spare bulb, halogen, 2,5 V

### Juego para Oftalmología completo en estuche, consta de

- 1 Mango de pilas (sin pilas)
- 1 Oftalmoscopio con bombilla de halógeno, 2,5 V
- 1 Lupa, aumento 5 x
- 1 Bombilla de repuesto, 2,5 V

### Set per oftalmologia completo in astuccio, composta da:

- 1 Manico per pila (senza pila)
- 1 Testa di oftalmoscopio con lampadina alogena, 2,5 V
- 1 Lente, ingrandimento 5 x
- 1 Lampadina di ricambio, alogena, 2,5 V

### Diagnostikbesteck komplett in Etui, bestehend aus:

- 1 Batteriehandgriff (ohne Batterien)
- 1 Ophthalmoskop mit Halogenbirne, 2,5 V
- 1 Otoskopkopf mit Halogenbirne, 2,5 V
- 1 Wiederverwendbare Ohrtrichter, Ø 2,0 | 3,0 | 4,0 | 5,0 mm
- 3 Einwegohrtrichter, Ø 2,5 | 4,0 mm
- 1 Operationslupe, 4-fache Vergrößerung
- 2 Ersatzbirnchen, Halogen, 2,5 V

### Diagnostic Set complete in case, consisting of:

- 1 Battery handle (without batteries)
- 1 Ophthalmoscope with halogen bulb, 2,5 V
- 1 Otoscope head with halogen bulb, 2,5 V
- 1 Reusable ear specula, Ø 2,0 | 3,0 | 4,0 | 5,0 mm
- 3 Disposable ear specula, Ø 2,5 | 4,0 mm
- 1 Magnifying glass for operation, 4 x
- 2 Spare bulb, halogen, 2,5 V

### Juego de Diagnóstico completo en estuche, consta de

- 1 Mango de pilas (sin pilas)
- 1 Oftalmoscopio con bombilla de halógeno, 2,5 V
- 1 Cabeza de otoscopio con bombilla de halógeno, 2,5 V
- 1 Espéculos auriculares reutilizables, Ø 2,0 | 3,0 | 4,0 | 5,0 mm
- 3 Espéculos auriculares desechables, Ø 2,5 | 4,0 mm
- 1 Lupa para operaciones, aumento 4 x
- 2 Bombilla de repuesto, 2,5 V

### Set per Diagnostica completo in astuccio, composta da:

- 1 Manico per pila (senza pila)
- 1 Testa di oftalmoscopio con lampadina alogena, 2,5 V
- 1 Testa di otoscopio con lampadina alogena, 2,5 V
- 1 Specolo auricolare riutilizzabile, Ø 2,0 | 3,0 | 4,0 | 5,0 mm
- 3 Specolo auricolare monouso, Ø 2,5 | 4,0 mm
- 1 Lente per operazione, ingrandimento 4 x
- 2 Lampadina di ricambio, alogena, 2,5 V





## RI-SCOPE

**10-048-02** 2,5 V

### Universal Diagnostikbesteck komplett in Etui, bestehend aus:

- 1 Batteriehandgriff (ohne Batterien)
- 1 Ophthalmoskop mit Halogenbirne, 2,5 V
- 1 Otoskopkopf mit Halogenbirne, 2,5 V
- 1 Nasenspekulum mit Lampe und Lupe
- 1 Mundspatelhalter mit Lampe
- 1 Lampenträger mit Lampe
- 1 Kehlkopfspiegel für Lampenträger, Ø 20,0 | 22,0 mm
- 1 Wiederverwendbare Ohrtrichter, Ø 2,0 | 3,0 | 4,0 | 5,0 mm
- 3 Einwegohrtrichter, Ø 2,5 | 4,0 mm
- 2 Ersatzbirnchen, Halogen, 2,5 V

### Universal Diagnostic Set complete in case, consisting of:

- 1 Battery handle (without batteries)
- 1 Ophthalmoscope with halogen bulb, 2,5 V
- 1 Otoscope head with halogen bulb, 2,5 V
- 1 Nasal specula with bulb and magnifier
- 1 Tongue depressor holder with bulb
- 1 Lamp holder with bulb
- 1 Laryngeal mirrors for lamp holder, Ø 20,0 | 22,0 mm
- 1 Reusable ear specula, Ø 2,0 | 3,0 | 4,0 | 5,0 mm
- 3 Disposable ear specula, Ø 2,5 | 4,0 mm
- 2 Spare bulb, halogen, 2,5 V

### Universal juego de Diagnóstico completo en estuche, consta de

- 1 Mango de pilas (sin pilas)
- 1 Oftalmoscopio con bombilla de halógeno, 2,5 V
- 1 Cabeza de otoscopio con bombilla de halógeno, 2,5 V
- 1 Espéculo nasal con bombilla y lupa
- 1 Soporte de bajalengua con bombilla
- 1 Porta bombilla con bombilla incluida
- 1 Espejos laringeos para el porta-bombilla, Ø 20,0 | 22,0 mm
- 1 Espéculos auriculares reutilizables, Ø 2,0 | 3,0 | 4,0 | 5,0 mm
- 3 Espéculos auriculares desechables specolo auricolare
- 2 Bombilla de repuesto, 2,5 V

### Universal Set per Diagnostica completo in astuccio, composta da:

- 1 Manico per pila (senza pila)
- 1 Testa di oftalmoscopio con lampadina alogena, 2,5 V
- 1 Testa di otoscopio con lampadina alogena, 2,5 V
- 1 Specolo nasale con lampada
- 1 Spatola abbassalingua con lampada
- 1 Porta-lampada con lampada
- 1 Specchietti auricolari per porta-lampada, Ø 20,0 | 22,0 mm
- 1 Specolo auricolare riutilizzabile, Ø 2,0 | 3,0 | 4,0 | 5,0 mm
- 3 Specolo auricolare monouso, Ø 2,5 | 4,0 mm
- 2 Lampadina di ricambio, alogena, 2,5 V



## RI-SCOPE

**10-048-05** 2,5V

### HNO Diagnostikbesteck komplett in Etui, bestehend aus:

- 1 Batteriehandgriff (ohne Batterien)
- 1 Otoskopkopf mit Halogenbirne, 2,5 V
- 1 Nasenspekulum mit Lampe und Lupe
- 1 Mundspatelhalter mit Lampe
- 1 Operationslupe, 4-fache Vergrößerung
- 1 Wiederverwendbare Ohrtrichter, Ø 2,0 | 3,0 | 4,0 | 5,0 mm
- 3 Einwegohrtrichter, Ø 2,5 | 4,0 mm
- 1 Ersatzbirnchen, Halogen, 2,5 V

### ENT Diagnostic Set complete in case, consisting of:

- 1 Battery handle (without batteries)
- 1 Otoscope head with halogen bulb, 2,5 V
- 1 Nasal specula with bulb and magnifier
- 1 Tongue depressor holder with bulb
- 1 Magnifying glass for operation, 4 x
- 1 Reusable ear specula, Ø 2,0 | 3,0 | 4,0 | 5,0 mm
- 3 Disposable ear specula, Ø 2,5 | 4,0 mm
- 1 Spare bulb, halogen, 2,5 V

### ORL juego de Diagnóstico completo en estuche, consta de

- 1 Mango de pilas (sin pilas)
- 1 Cabeza de otoscopio con bombilla de halógeno, 2,5 V
- 1 Espéculo nasal con bombilla y lupa
- 1 Soporte de bajalengua con bombilla
- 1 Lupa para operaciones, aumento 4 x
- 1 Espéculos auriculares reutilizables, Ø 2,0 | 3,0 | 4,0 | 5,0 mm
- 3 Espéculos auriculares desechables speculo auricolare
- 1 Bombilla de repuesto, 2,5 V

### ORL Set per Diagnostica completo in astuccio, composta da:

- 1 Manico per pila (senza pila)
- 1 Testa di otoscopio con lampadina alogena, 2,5 V
- 1 Specolo nasale con lampada
- 1 Spatola abbassalingua con lampada
- 1 Lente per operazione, ingrandimento 4 x
- 1 Specolo auricolare riutilizzabile, Ø 2,0 | 3,0 | 4,0 | 5,0 mm
- 3 Specolo auricolare monouso, Ø 2,5 | 4,0 mm
- 1 Lampadina di ricambio, alogena, 2,5 V



## RI-SCOPE

10-048-18 2,5V

### Otoskopbesteck komplett in Etui, bestehend aus:

- 1 Batteriehandgriff (ohne Batterien)
- 1 Otoskopkopf mit Halogenbirne, 2,5 V
- 1 Wiederverwendbare Ohrtrichter, Ø 2,0 | 3,0 | 4,0 | 5,0 mm
- 3 Einwegohrtrichter, Ø 2,5 | 4,0 mm
- 1 Operationslupe, 4-fache Vergrößerung
- 1 Ersatzbirnchen, Halogen, 2,5 V

### Otoscope Set complete in case, consisting of:

- 1 Battery handle (without batteries)
- 1 Otoscope head with halogen bulb, 2,5 V
- 1 Reusable ear specula, Ø 2,0 | 3,0 | 4,0 | 5,0 mm
- 3 Disposable ear specula, Ø 2,5 | 4,0 mm
- 1 Magnifying glass for operation, 4 x
- 1 Spare bulb, halogen, 2,5 V

### Juego para otoscopia completo en estuche, consta de

- 1 Mango de pilas (sin pilas)
- 1 Cabeza de otoscopio con bombilla de halógeno, 2,5 V
- 1 Espéculos auriculares reutilizables, Ø 2,0 | 3,0 | 4,0 | 5,0 mm
- 3 Espéculos auriculares desechables, Ø 2,5 | 4,0 mm
- 1 Lupa para operaciones, aumento 4 x
- 1 Bombilla de repuesto, 2,5 V

### Set di otoscopia completo in astuccio, composta da:

- 1 Manico per pila (senza pila)
- 1 Testa di otoscopio con lampadina alogena, 2,5 V
- 1 Specolo auricolare riutilizzabile, Ø 2,0 | 3,0 | 4,0 | 5,0 mm
- 3 Specolo auricolare monouso, Ø 2,5 | 4,0 mm
- 1 Lente per operazione, ingrandimento 4 x
- 1 Lampadina di ricambio, alogena, 2,5 V

### Otoskopbesteck komplett in Etui, bestehend aus:

- 1 Batteriehandgriff (ohne Batterien)
- 1 Otoskopkopf mit Vaccumbirne, 2,7 V
- 1 Wiederverwendbare Ohrtrichter, Ø 2,0 | 3,0 | 4,0 mm

### Otoscope Set complete in case, consisting of:

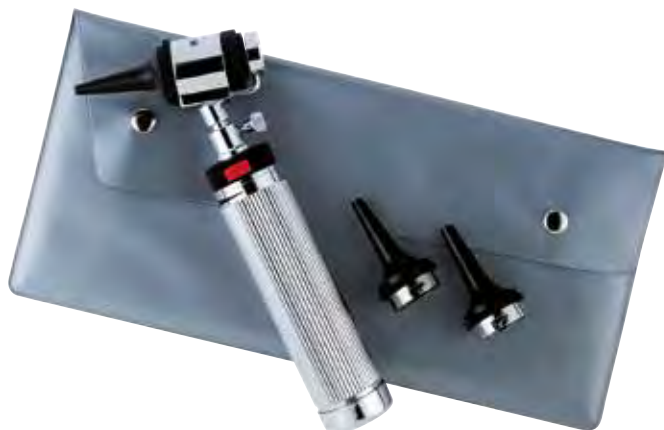
- 1 Battery handle (without batteries)
- 1 Otoscope head with vacuum bulb, 2,7 V
- 1 Reusable ear specula, Ø 2,0 | 3,0 | 4,0 mm

### Juego para otoscopia completo en estuche, consta de

- 1 Mango de pilas (sin pilas)
- 1 Cabeza de otoscopio con bombilla de vacío, 2,7 V
- 1 Espéculos auriculares reutilizables, Ø 2,0 | 3,0 | 4,0 mm

### Set di otoscopia completo in astuccio, composta da:

- 1 Manico per pila (senza pila)
- 1 Testa di otoscopio con lampadina sotto vuoto, 2,7 V
- 1 Specolo auricolare riutilizzabile, Ø 2,0 | 3,0 | 4,0 mm



## UNI I

10-048-15 2,7V



### UNI II

10-048-20 2,7V

#### Opthalmoskopbesteck komplett in Etui, bestehend aus:

1 Batteriehandgriff (ohne Batterien)  
1 Opthalmoskopkopf mit Vaccumbirne, 2,7 V

#### Opthalmoscope Set complete in case, consisting of:

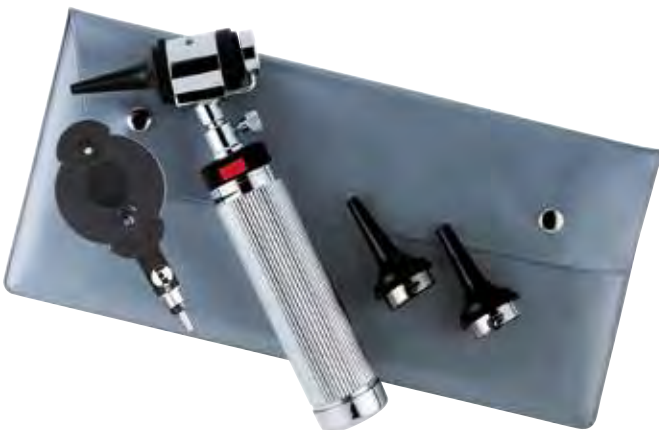
1 Battery handle (without batteries)  
1 Opthalmoscope head with vaccum bulb, 2,7 V

#### Juego para oftalmología completo en estuche, consta de

1 Mango de pilas (sin pilas)  
1 Cabeza de oftalmología con bombilla de vacío, 2,7 V

#### Set di oftalmologia completo in astuccio, composta da:

1 Manico per pila (senza pila)  
1 Testa di oftalmologia con lampadina sotto vuoto, 2,7 V



### UNI III

10-048-19 2,7V

#### Diagnostikbesteck komplett in Etui, bestehend aus:

1 Batteriehandgriff (ohne Batterien)  
1 Opthalmoskopkopf mit Vaccumbirne, 2,7 V  
1 Otoskopkopf mit Vaccumbirne, 2,7 V  
1 Wiederverwendbare Ohrtrichter, Ø 2,0 | 3,0 | 4,0 mm

#### Diagnostic Set complete in case, consisting of:

1 Battery handle (without batteries)  
1 Opthalmoscope head with vaccum bulb, 2,7 V  
1 Otoscope head with vaccum bulb, 2,7 V  
1 Reusable ear specula, Ø 2,0 | 3,0 | 4,0 mm

#### Juego de Diagnóstico completo en estuche, consta de

1 Mango de pilas (sin pilas)  
1 Cabeza de oftalmología con bombilla de vacío, 2,7 V  
1 Cabeza de otoscopio con bombilla de vacío, 2,7 V  
1 Espéculos auriculares reutilizables, Ø 2,0 | 3,0 | 4,0 mm

#### Set per Diagnostica completo in astuccio, composta da:

1 Manico per pila (senza pila)  
1 Testa di oftalmologia con lampadina sotto vuoto, 2,7 V  
1 Testa di otoscopio con lampadina sotto vuoto, 2,7 V  
1 Specolo auricolare riutilizzabile, Ø 2,0 | 3,0 | 4,0 mm



## PREMIUM

10-048-30 2,7V

### Diagnostikbesteck komplett in Etui, bestehend aus:

- 1 Batteriehandgriff (ohne Batterien)
- 1 Ophthalmoskop mit Vaccumbirne, 2,7 V
- 1 Otoskopkopf mit Vaccumbirne, 2,7 V
- 1 Wiederverwendbare Ohrtrichter, Ø 2,0 | 3,0 | 4,0 mm
- 1 Nasenspekulum
- 1 Lampenträger
- 1 Kehlkopfspiegel für Lampenträger, Ø 20,0 | 22,0 mm
- 1 Mundspatelhalter
- 1 Ersatzbirnchen, Vacuum, 2,7 V

### Diagnostic Set complete in case, consisting of:

- 1 Battery handle (without batteries)
- 1 Ophthalmoscope with vacuum bulb, 2,7 V
- 1 Otoscope head with vacuum bulb, 2,7 V
- 1 Reusable ear specula, Ø 2,0 | 3,0 | 4,0 mm
- 1 Nasal specula
- 1 Lampenträger
- 1 Laryngeal mirrors for lamp holder, Ø 20,0 | 22,0 mm
- 1 Tongue depressor holder
- 1 Spare bulb, vacuum, 2,7 V

### Juego de Diagnóstico completo en estuche, consta de

- 1 Mango de pilas (sin pilas)
- 1 Oftalmoscopio con bombilla de vacío, 2,7 V
- 1 Cabeza de otoscopio con bombilla de vacío, 2,7 V
- 1 Espéculos auriculares reutilizables, Ø 2,0 | 3,0 | 4,0 mm
- 1 Espéculo nasal
- 1 Porta bombilla
- 1 Espejos laringeos para el porta-bombilla, Ø 20,0 | 22,0 mm
- 1 Soporte de bajalengua
- 1 Bombilla de repuesto, vacío, 2,7 V

### Set per Diagnostica completo in astuccio, composta da:

- 1 Manico per pila (senza pila)
- 1 Testa di oftalmoscopio con lampadina sotto vuoto, 2,7 V
- 1 Testa di otoscopio con con lampadina sotto vuoto, 2,7 V
- 1 Specolo auricolare riutilizzabile, Ø 2,0 | 3,0 | 4,0 mm
- 1 Specolo nasale
- 1 Porta-lampada
- 1 Specchietti auricolari per porta-lampada, Ø 20,0 | 22,0 mm
- 1 Soporte de bajalengua
- 1 Lampadina di ricambio, sotto vuoto, 2,7 V



Reflexspiegel, komplett  
Reflex head mirror, complete  
Espejo frontal, completo  
Specchio frontale, completo

## ZIEGLER

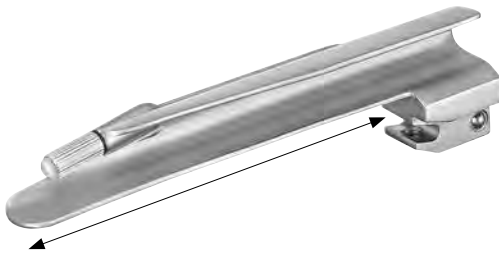
10-049-00 Ø 90,0 mm

Stirnband aus weißem Celluloid mit Gelenk  
Head band of white celluloid with joint  
Cinta de celuloide blanco con articulación  
Fascia frontale di celuloide bianca con snodo sferico



## MURPHY

10-049-15



### NEGUS (GUEDEL)

- 10-050-01** Fig 1 | 73 mm
- 10-050-02** Fig 2 | 102 mm
- 10-050-03** Fig 3 | 110 mm
- 10-050-04** Fig 4 | 135 mm



#### **10-063-11** 2,5 V

Ersatzbirne, Fig. 1  
Spare bulb, Fig. 1  
Bombilla de repuesto, Fig. 1  
Lampadina di ricambio, Fig. 1



#### **10-063-12** 2,5 V

Ersatzbirne, Fig. 2 - 4  
Spare bulb, Fig. 2 - 4  
Bombilla de repuesto, Fig. 2 - 4  
Lampadina di ricambio, Fig. 2 - 4



### NEGUS (GUEDEL)

#### **10-070-00** Fig. 1 - 2

Satz, komplett im Etui, bestehend aus:  
Set, complete in case, consisting of:  
Juego, completo en estuche, compuesto de:  
Set, completo di custodia, composto da:

- 1 Griff, handle, mango, manico (10-061-00)
- 1 Spatel, blade, espatula, lame Fig. 1 - 2 (10-050-01 | 10-050-02)

### NEGUS (GUEDEL)

#### **10-071-00** Fig. 1 - 4

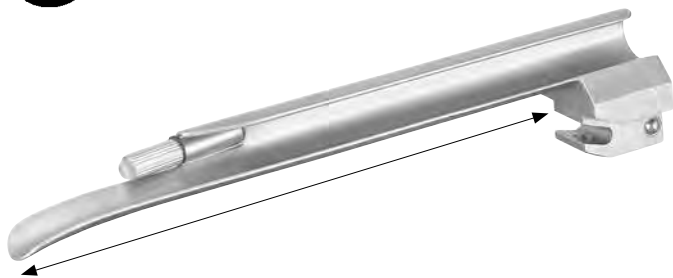
Satz, komplett im Etui, bestehend aus:  
Set, complete in case, consisting of:  
Juego, completo en estuche, compuesto de:  
Set, completo di custodia, composto da:

- 1 Griff, handle, mango, manico (10-061-00)
- 1 Spatel, blade, espatula, lame Fig. 1 - 4 (10-050-01 - 10-050-04)





J



### MILLER

<b>10-051-00</b>	Fig 0   55 mm
<b>10-051-01</b>	Fig 1   80 mm
<b>10-051-02</b>	Fig 2   130 mm
<b>10-051-03</b>	Fig 3   170 mm
<b>10-051-04</b>	Fig 4   180 mm



**10-063-11** 2,5 V

Ersatzbirne, Fig. 0 - 1  
 Spare bulb, Fig. 0 - 1  
 Bombilla de repuesto, Fig. 0 - 1  
 Lampadina di ricambio, Fig. 0 - 1



**10-063-12** 2,5 V

Ersatzbirne, Fig. 2 - 4  
 Spare bulb, Fig. 2 - 4  
 Bombilla de repuesto, Fig. 2 - 4  
 Lampadina di ricambio, Fig. 2 - 4

Fig. 0	Fig. 3
Neugeborene Newborns Recién nacidos Neonati	Erwachsene (klein) Adult (small) Adultos (pequeño) Adulti (piccolo)
Fig. 1	Fig. 4
Kleinkinder Infants Niños pequeños Bambini in età da allattamento	Erwachsene (mittel) Adult (medium) Adultos (mediano) Adulti (medio)
Fig. 2	Fig. 5
Kinder Children Niños Bambini	Erwachsene (groß) Adult (large) Adultos (grande) Adulti (grande)



### MILLER

**10-073-00** Fig. 2 - 4

Satz, komplett im Etui, bestehend aus:  
 Set, complete in case, consisting of:  
 Juego, completo en estuche, compuesto de:  
 Set, completo di custodia, composto da:

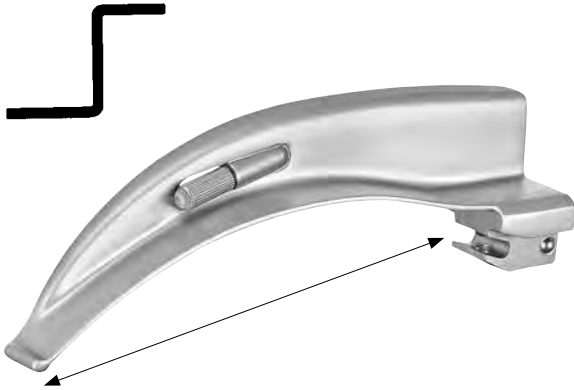
- 1 Griff, handle, mango, manico (10-061-00)
- 1 Spatel, blade, espatula, lame Fig. 2 - 4 (10-051-02 - 10-051-04)

### MILLER

**10-074-00** Fig. 1 - 4

Satz, komplett im Etui, bestehend aus:  
 Set, complete in case, consisting of:  
 Juego, completo en estuche, compuesto de:  
 Set, completo di custodia, composto da:

- 1 Griff, handle, mango, manico (10-061-00)
- 1 Spatel, blade, espatula, lame Fig. 1 - 4 (10-051-01 - 10-051-04)



### MC INTOSH

<b>10-052-00</b>	Fig 0   56 mm
<b>10-052-01</b>	Fig 1   68 mm
<b>10-052-02</b>	Fig 2   88 mm
<b>10-052-03</b>	Fig 3   108 mm
<b>10-052-04</b>	Fig 4   128 mm
<b>10-052-05</b>	Fig 5   150 mm



<b>Fig. 0</b>	<b>Fig. 3</b>
Neugeborene Newborns Recién nacidos Neonati	Erwachsene (klein) Adult (small) Adultos (pequeño) Adulti (piccolo)
<b>Fig. 1</b>	<b>Fig. 4</b>
Kleinkinder Infants Niños pequeños Bambini in età da allattamento	Erwachsene (mittel) Adult (medium) Adultos (mediano) Adulti (medio)
<b>Fig. 2</b>	<b>Fig. 5</b>
Kinder Children Niños Bambini	Erwachsene (groß) Adult (large) Adultos (grande) Adulti (grande)



**10-063-11** 2,5 V

Ersatzbirne, Fig. 0  
Spare bulb, Fig. 0  
Bombilla de repuesto, Fig. 0  
Lampadina di ricambio, Fig. 0



**10-063-12** 2,5 V

Ersatzbirne, Fig. 1 - 5  
Spare bulb, Fig. 1 - 5  
Bombilla de repuesto, Fig. 1 - 5  
Lampadina di ricambio, Fig. 1 - 5

### MC INTOSH

**10-076-00** Fig. 1 - 3

Satz, komplett im Etui, bestehend aus:  
Set, complete in case, consisting of:  
Juego, completo en estuche, compuesto de:  
Set, completo di custodia, composto da:

1 Griff, handle, mango, manico (10-061-00)  
1 Spatel, blade, espatula, lame Fig. 1 - 3 (10-052-01 - 10-050-03)

### MC INTOSH

**10-076-01** Fig. 2 - 4

Satz, komplett im Etui, bestehend aus:  
Set, complete in case, consisting of:  
Juego, completo en estuche, compuesto de:  
Set, completo di custodia, composto da:

1 Griff, handle, mango, manico (10-061-00)  
1 Spatel, blade, espatula, lame Fig. 2 - 4 (10-050-02 - 10-050-04)

### MC INTOSH

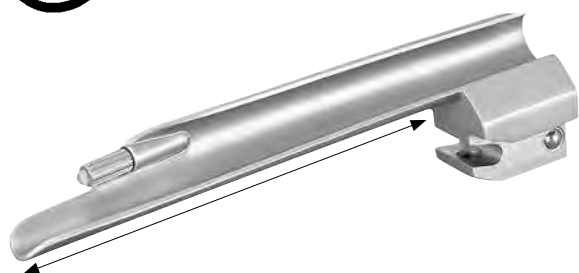
**10-077-00** Fig. 1 - 4

Satz, komplett im Etui, bestehend aus:  
Set, complete in case, consisting of:  
Juego, completo en estuche, compuesto de:  
Set, completo di custodia, composto da:

1 Griff, handle, mango, manico (10-061-00)  
1 Spatel, blade, espatula, lame Fig. 1 - 4 (10-052-01 - 10-052-04)







## WIS-FOREGGER

<b>10-053-00</b>	Fig 0   73 mm
<b>10-053-01</b>	Fig 1   93 mm
<b>10-053-02</b>	Fig 2   111 mm
<b>10-053-03</b>	Fig 3   140 mm
<b>10-053-04</b>	Fig 4   165 mm



Fig. 0	Fig. 3
Neugeborene Newborns Recién nacidos Neonati	Erwachsene (klein) Adult (small) Adultos (pequeño) Adulti (piccolo)
Fig. 1	Fig. 4
Kleinkinder Infants Niños pequeños Bambini in età da allattamento	Erwachsene (mittel) Adult (medium) Adultos (mediano) Adulti (medio)
Fig. 2	Fig. 5
Kinder Children Niños Bambini	Erwachsene (groß) Adult (large) Adultos (grande) Adulti (grande)



**10-063-11** 2,5 V

Ersatzbirne, Fig. 0 - 1  
 Spare bulb, Fig. 0 - 1  
 Bombilla de repuesto, Fig. 0 - 1  
 Lampadina di ricambio, Fig. 0 - 1



**10-063-12** 2,5 V

Ersatzbirne, Fig. 2 - 4  
 Spare bulb, Fig. 2 - 4  
 Bombilla de repuesto, Fig. 2 - 4  
 Lampadina di ricambio, Fig. 2 - 4



## WIS-FOREGGER

**10-078-00** Fig. 2 - 4

Satz, komplett im Etui, bestehend aus:  
 Set, complete in case, consisting of:  
 Juego, completo en estuche, compuesto de:  
 Set, completo di custodia, composto da:

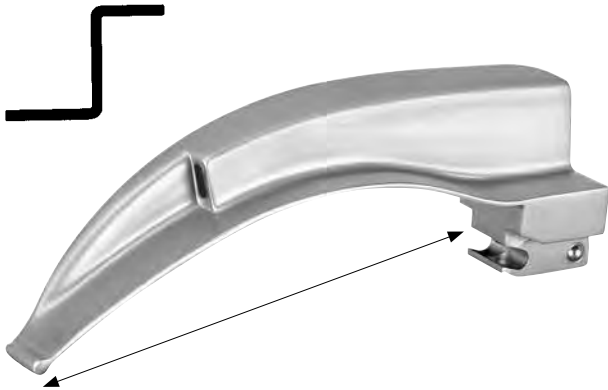
1 Griff, handle, mango, manico (10-061-00)  
 1 Spatel, blade, espatula, lame Fig. 2 - 4 (10-053-02 - 10-053-04)

## WIS-FOREGGER

**10-079-00** Fig. 1 - 4

Satz, komplett im Etui, bestehend aus:  
 Set, complete in case, consisting of:  
 Juego, completo en estuche, compuesto de:  
 Set, completo di custodia, composto da:

1 Griff, handle, mango, manico (10-061-00)  
 1 Spatel, blade, espatula, lame Fig. 1 - 4 (10-053-01 - 10-053-04)



## MC INTOSH

<b>10-054-00</b>	Fig 0   56 mm
<b>10-054-01</b>	Fig 1   68 mm
<b>10-054-02</b>	Fig 2   88 mm
<b>10-054-03</b>	Fig 3   108 mm
<b>10-054-04</b>	Fig 4   128 mm



Laryngoskop-Spatel mit integriertem Kaltlichtträger  
Laryngoscope blade with integrated cold light carrier  
Espátulas de laringoscopios con luz fría integrada  
Spatole per laringoscopia, luce fredda

<b>Fig. 0</b>	<b>Fig. 3</b>
Neugeborene Newborns Recién nacidos Neonati	Erwachsene (klein) Adult (small) Adultos (pequeño) Adulti (piccolo)
<b>Fig. 1</b>	<b>Fig. 4</b>
Kleinkinder Infants Niños pequeños Bambini in età da allattamento	Erwachsene (mittel) Adult (medium) Adultos (mediano) Adulti (medio)
<b>Fig. 2</b>	<b>Fig. 5</b>
Kinder Children Niños Bambini	Erwachsene (groß) Adult (large) Adultos (grande) Adulti (grande)



## MC INTOSH

**10-081-00** Fig. 1 - 3

Satz, komplett im Etui, bestehend aus:  
Set, complete in case, consisting of:  
Juego, completo en estuche, compuesto de:  
Set, completo di custodia, composto da:

1 Griff, handle, mango, manico (10-065-00)  
1 Spatel, blade, espatula, lame Fig. 1 - 3 (10-054-01 - 10-054-03)

## MC INTOSH

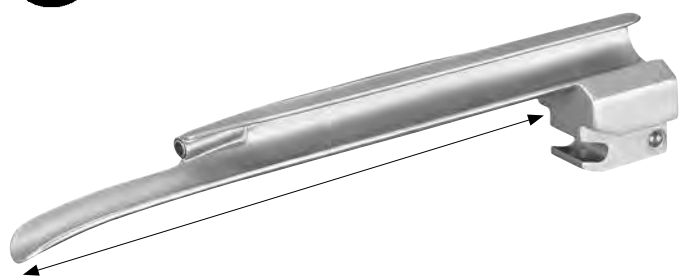
**10-082-00** Fig. 1 - 4

Satz, komplett im Etui, bestehend aus:  
Set, complete in case, consisting of:  
Juego, completo en estuche, compuesto de:  
Set, completo di custodia, composto da:

1 Griff, handle, mango, manico (10-065-00)  
1 Spatel, blade, espatula, lame Fig. 1 - 4 (10-054-01 - 10-054-04)



J



## MILLER

<b>10-055-00</b>	Fig 0   55 mm
<b>10-055-01</b>	Fig 1   80 mm
<b>10-055-02</b>	Fig 2   130 mm
<b>10-055-03</b>	Fig 3   170 mm
<b>10-055-04</b>	Fig 4   180 mm



Laryngoskop-Spatel mit integriertem Kaltlichtträger  
 Laryngoscope blade with integrated cold light carrier  
 Espátulas de laringoscopios con luz fría integrada  
 Spatole per laringoscopia, luce fredda

<b>Fig. 0</b>	<b>Fig. 3</b>
Neugeborene Newborns Recién nacidos Neonati	Erwachsene (klein) Adult (small) Adultos (pequeño) Adulti (piccolo)
<b>Fig. 1</b>	<b>Fig. 4</b>
Kleinkinder Infants Niños pequeños Bambini in età da allattamento	Erwachsene (mittel) Adult (medium) Adultos (mediano) Adulti (medio)
<b>Fig. 2</b>	<b>Fig. 5</b>
Kinder Children Niños Bambini	Erwachsene (groß) Adult (large) Adultos (grande) Adulti (grande)



## MILLER

**10-083-00** Fig. 2 - 4

Satz, komplett im Etui, bestehend aus:  
 Set, complete in case, consisting of:  
 Juego, completo en estuche, compuesto de:  
 Set, completo di custodia, composto da:

- 1 Griff, handle, mango, manico (10-065-00)
- 1 Spatel, blade, espatula, lame Fig. 2 - 4 (10-055-02 - 10-055-04)

## MILLER

**10-084-00** Fig. 1 - 4

Satz, komplett im Etui, bestehend aus:  
 Set, complete in case, consisting of:  
 Juego, completo en estuche, compuesto de:  
 Set, completo di custodia, composto da:

- 1 Griff, handle, mango, manico (10-065-00)
- 1 Spatel, blade, espatula, lame Fig. 1 - 4 (10-055-01 - 10-055-04)



Batteriegriff (2 AA Batterien, 1,5 Volt, sind erforderlich)  
Battery handle (2 AA batteries, 1.5 volt, are required)  
Mango de pila (se necesitan 2 pilas AA de 1,5 V)  
Manico per pila (2 pile AA di 1,5 volt sono necessarie)

**10-060-00** Ø 18,0 mm



Batteriegriff (2 A Batterien, 1,5 Volt, sind erforderlich)  
Battery handle (2 A batteries, 1.5 volt, are required)  
Mango de pila (se necesitan 2 pilas A de 1,5 V)  
Manico per pila (2 pile A di 1,5 volt sono necessarie)

**10-061-00** Ø 30,0 mm

Batteriegriff (1 A Batterien, 1,5 Volt, sind erforderlich)  
Battery handle (1 A batteries, 1.5 volt, are required)  
Mango de pila (se necesitan 1 pilas A de 1,5 V)  
Manico per pila (1 pile A di 1,5 volt sono necessarie)



**10-062-00** Ø 30,0 mm



Batteriegriff (für Trafoanschluß)  
Battery handle (for transformer)  
Mango de pila (para Transformador)  
Manico per pila (per Trasformatore)

**10-063-00** Ø 30,0 mm



Transformator  
Transformer  
Transformador  
Trasformatore

**10-063-01** 220 V



Batterieladegerät  
Battery charging device  
Cargador de batería  
Caricabatteria per batterie

**10-063-03**



Batteriegriff (2 AA Batterien, 1,5 Volt, sind erforderlich)  
 Battery handle (2 AA batteries, 1.5 volt, are required)  
 Mango de pila (senecesitan 2 pilas AA de 1,5 V)  
 Manico per pila (2 pile AA di 1,5 volt sono necessarie)

**10-064-00** Ø 18,0 mm



Batteriegriff (2 A Batterien, 1,5 Volt, sind erforderlich)  
 Battery handle (2 A batteries, 1.5 volt, are required)  
 Mango de pila (senecesitan 2 pilas A de 1,5 V)  
 Manico per pila (2 pile A di 1,5 volt sono necessarie)

**10-065-00** Ø 30,0 mm



Batteriegriff (für Trafoanschluß)  
 Battery handle (for transformer)  
 Mango de pila (para Transformador)  
 Manico per pila (per Transformatore)

**10-065-01** Ø 30,0 mm



**10-069-03** 2,5 V

LED Lampe  
 LED bulb  
 Lámpara de LED  
 Lampadina LED



**10-069-02** 2,5 V

Xenon Lampe  
 Xenon bulb  
 Lámpara de halógeno  
 Lampadina alogena



**10-069-01** 2,5 V

Halogen Lampe  
 Halogen bulb  
 Lámpara de xenón  
 Lampadina xenon



**10-069-00** 2,5 V

Krypton Lampe  
 Krypton bulb  
 Lámpara de criptón  
 Lampadina krypton



**LED**  
**10-069-30** Ø 30,0 mm

Griff mit Akku (10-069-39)  
 Handle with accumulator (10-069-39)  
 Mango con acumulador (10-069-39)  
 Manico con accumulatore (10-069-39)



**LED**  
**10-069-40** 115 V  
**10-069-50** 230 V

Ladegerät  
 Charging device  
 Cargador  
 Ricaricatore



**BAYHA I Fig. 1**

**10-100-01** 13,0 cm, 5 1/8"



**BAYHA I Fig. 2**

**10-100-02** 13,0 cm, 5 1/8"



**BAYHA I Fig. 3**

**10-100-03** 20,0 cm, 8"



**BAYHA I Fig. 4**

**10-100-04** 16,0 cm, 6 1/4"



**BAYHA I Fig. 5**

**10-100-05** 15,0 cm, 6"



**Nr. 3**

**10-103-01** 12,0 cm, 4 3/4"



**Nr. 3**

**10-103-03** 12,0 cm, 4 3/4"



**Nr. 3 L**

**10-103-04** 21,0 cm, 8 1/4"





Fig.  
10-15C

**Nr. 3 L**

**10-103-05** 20,5 cm, 8"



Fig.  
10-15C

**Nr. 7**

**10-103-06** 16,0 cm, 6 ¼"



Fig.  
10-15C

**Nr. 7 K**

**10-103-07** 13,0 cm, 5"



Fig.  
10-15C

**Nr. 3**

**10-103-08** 21,5 cm, 8 ½"



Fig.  
10-15C

**Nr. 3 L**

**10-103-09** 21,5 cm, 8 ½"



PE  
PLASTIC

Fig.  
10-15C

**Nr. 3**

**10-103-10** 12,5 cm, 5"



Fig.  
10-15C

**Nr. 3**

**10-103-11** 15,5 cm, 6 ⅛"



Fig.  
10-15C

**Nr. 3**

**10-103-12** 14,5 cm, 5 ¾"



Fig.  
10-15C

**Nr. 3**

**10-103-13** 14,5 cm, 5 3/4"



Fig.  
10-15C

**Nr. 3**

**10-103-14** 15,0 cm, 6"



Fig.  
10-36D

**Nr. 3 + 4**

**10-103-34** 16,0 cm, 6 1/4"



Fig.  
18-36D

**Nr. 4**

**10-104-01** 13,5 cm, 5 1/4"



Fig.  
18-36D

**Nr. 4 L**

**10-104-04** 21,0 cm, 8 1/4"



Fig.  
18-36D

**Nr. 4 L**

**10-104-05** 21,0 cm, 8 1/4"



Fig.  
18-36D

**Nr. 4**

**10-104-08** 21,5 cm, 8 1/2"



PE  
PLASTIC

Fig.  
18-36D

**Nr. 4**

**10-104-10** 13,5 cm, 5 1/4"





Fig.  
10-15C

**Nr. 5**

**10-105-01** 16,0 cm, 6 1/4"



Fig.  
18-36D

**COLLIN I Nr. 8**

**10-108-00** 13,5 cm, 5 1/4"



Fig.  
18-36D

**COLLIN I Nr. 9**

**10-109-00** 14,5 cm, 5 3/4"



Verpackungseinheit: 10 St.  
 Packing unit: 10 pieces  
 Unidad: 10 piezas  
 Confezione: 10 pezzi

Rasierklingen, brechbar  
 Razor blades, breakable  
 Hojas de afeitar, rompibles  
 Lamette di rasoio, per rompere



STEEL  
STAINLESS

**10-116-00**



**TROUTMAN-CHRIS**

**10-110-10** 9,0 cm, 3 1/2"



**TROUTMAN-CHRIS**

**10-111-10** 9,0 cm, 3 1/2"



**10-112-11** 11,0 cm, 4 3/8"



**CASTROVIEJO**

**10-114-13** 13,0 cm, 5 1/8"



Verpackungseinheit: 100 St.  
Packing unit: 100 pieces  
Unidad: 100 piezas  
Confezione: 100 pezzi



**10-199-00** Fig. 10 - 36D

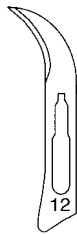
Skalpellklingen-Entferner  
Scalpel-Blade Remover  
Quita hojas  
Distributore lame



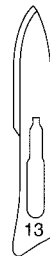
**Fig. 10**  
**10-153-10**



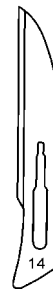
**Fig. 11**  
**10-153-11**



**Fig. 12**  
**10-153-12**



**Fig. 13**  
**10-153-13**



**Fig. 14**  
**10-153-14**



**Fig. 15**  
**10-153-15**



**Fig. 15C**  
**10-153-55**



**Fig. 18**  
**10-154-18**



**Fig. 19**  
**10-154-19**



**Fig. 20**  
**10-154-20**



**Fig. 21**  
**10-154-21**



Verpackungseinheit: 100 St.  
Packing unit: 100 pieces  
Unidad: 100 piezas  
Confezione: 100 pezzi



**Fig. 22**  
**10-154-22**



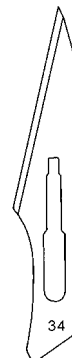
**Fig. 23**  
**10-154-23**



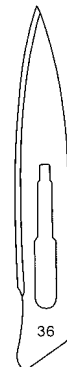
**Fig. 24**  
**10-154-24**



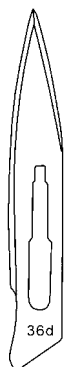
**Fig. 25**  
**10-154-25**



**Fig. 34**  
**10-154-34**




**Fig. 36**  
**10-154-36**



**Fig. 36D**  
**10-154-37**




 Verpackungseinheit: 10 St.  
 Packing unit: 10 pieces  
 Unidad: 100 piezas  
 Confezione: 10 pezzi



**Fig. 10**  
 10-253-10



**Fig. 11**  
 10-253-11



**Fig. 12**  
 10-253-12



**Fig. 13**  
 10-253-13



**Fig. 15**  
 10-253-15



**Fig. 15C**  
 10-253-51



**Fig. 18**  
 10-254-18



**Fig. 19**  
 10-254-19



**Fig. 20**  
 10-254-20



**Fig. 21**  
 10-254-21



**Fig. 22**  
 10-254-22



**Fig. 23**  
 10-254-23



**Fig. 24**  
 10-254-24

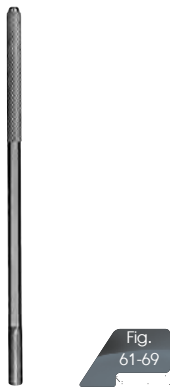


Fig.  
61-69

**10-260-10** 10,0 cm, 4"

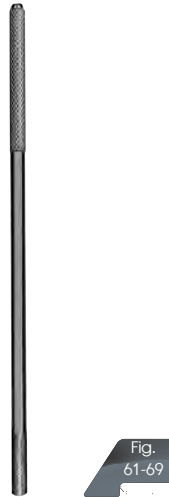


Fig.  
61-69

**10-260-13** 13,0 cm, 5 1/8"

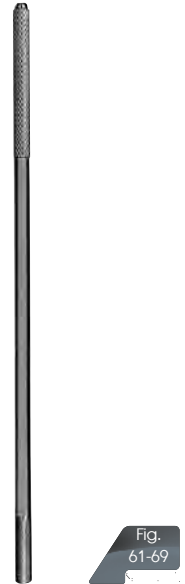


Fig.  
61-69

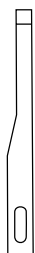
**10-260-15** 15,5 cm, 6 1/8"



Verpackungseinheit: 10 St.  
Packing unit: 10 pieces  
Unidad: 10 piezas  
Confezione: 10 pezzi



**FIG. 61**  
**10-265-61**



**FIG. 62**  
**10-265-62**



**FIG. 62S**  
**10-265-63**



**FIG. 64**  
**10-265-64**



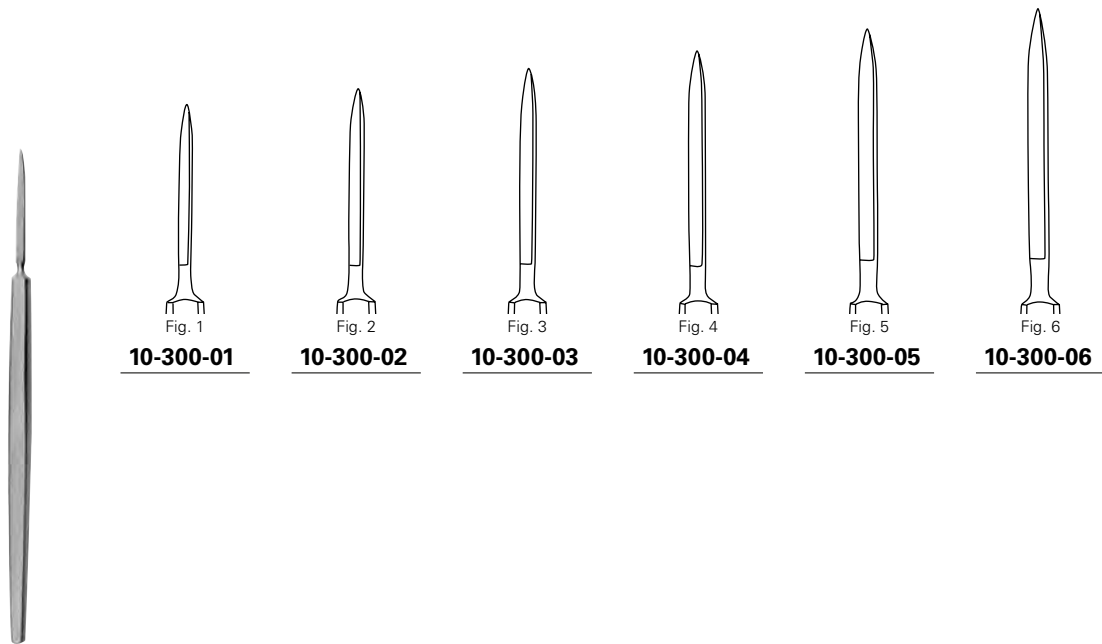
**FIG. 65**  
**10-265-65**



**FIG. 67**  
**10-265-67**

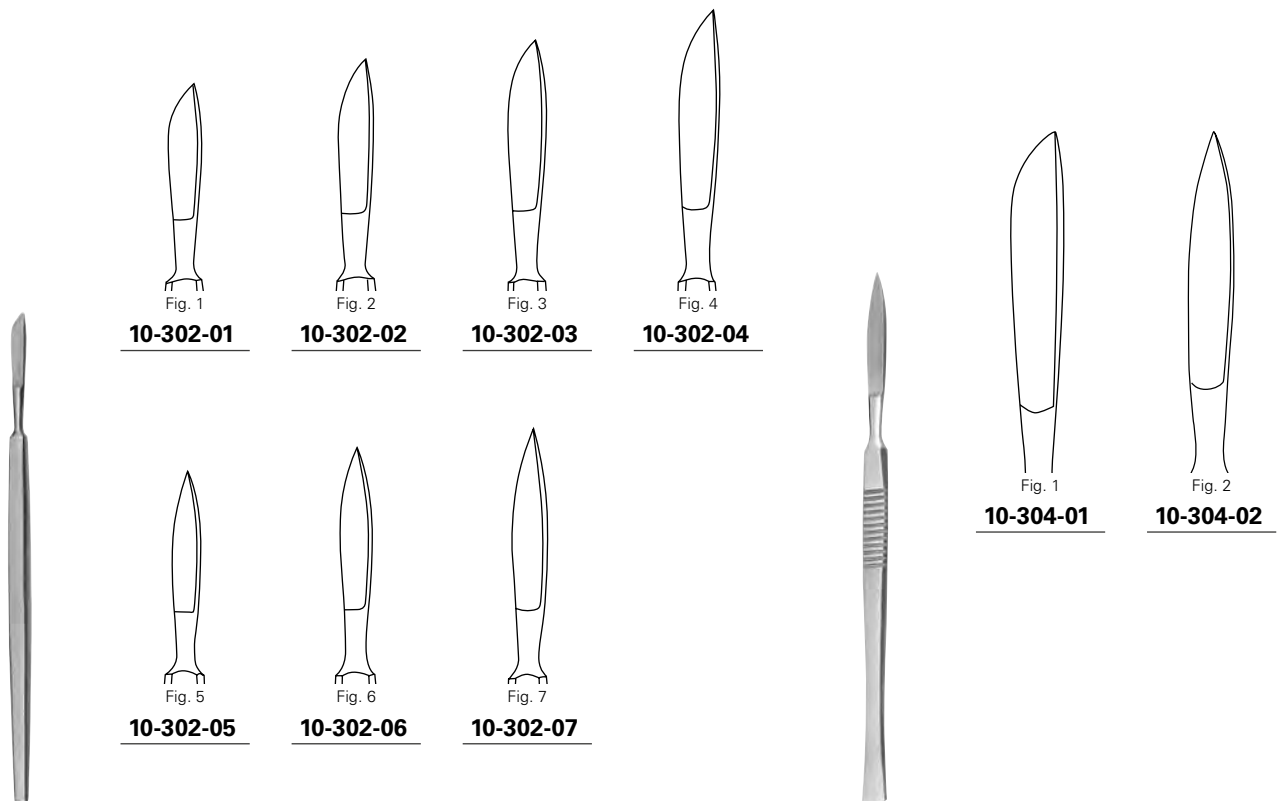


**FIG. 69**  
**10-265-69**



**GRAEFE**

**10-300-01 - 10-300-06** 13,0 cm, 5 1/8"



**GRAEFE**

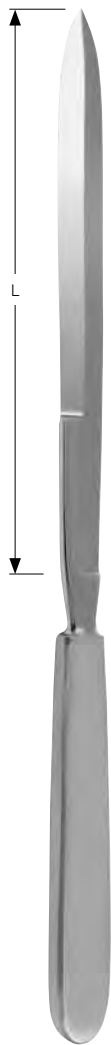
**10-302-01 - 10-302-07** 13,0 cm, 5 1/8"

**BERGMANN**

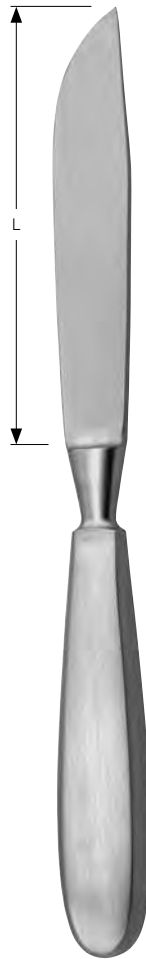
**10-304-01 - 10-304-02** 14,0 cm, 5 1/2"



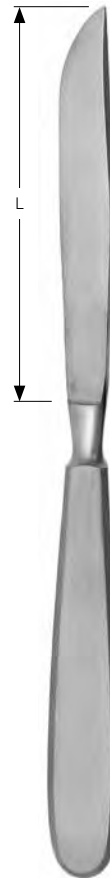
Amputationsmesser  
Amputating Knives  
Cuchillo para amputación  
Coltello per amputazione



Amputationsmesser  
Amputating Knives  
Cuchillo para amputación  
Coltello per amputazione



Amputationsmesser  
Amputating knife  
Cuchillo para amputación  
Coltello per amputazione



Phalangenmesser  
Phalangeal knife  
Cuchillo para lóbulus  
Coltello per lobi

## LISTON

<b>10-320-13</b>	13,0 cm, 5 1/8"
<b>10-320-16</b>	16,0 cm, 6 1/4"
<b>10-320-19</b>	19,0 cm, 7 1/2"
<b>10-320-22</b>	22,0 cm, 8 3/4"
<b>10-320-28</b>	28,0 cm, 11"

## CATLIN

<b>10-322-16</b>	16,0 cm, 6 1/4"
<b>10-322-19</b>	19,0 cm, 7 1/2"
<b>10-322-22</b>	22,0 cm, 8 3/4"

## LANGENBECK

<b>10-324-12</b>	13,0 cm, 4 3/4"	<b>10-326-10</b>	10,5 cm, 4 1/4"
------------------	-----------------	------------------	-----------------



Zwischenknochenmesser  
 Interosseous knife  
 Cuchillo interóseo  
 Coltello interosseo



Beinhautmesser  
 Periosteum knife  
 Cuchillo para periostio  
 Coltello per periosti



Resektionsmesser  
 Resection knife  
 Cuchillo para resección  
 Coltello per resezione



Resektionsmesser  
 Resection knife  
 Cuchillos para resección  
 Coltelli per resezione

**10-328-11** 10,5 cm, 4 1/4"

**10-330-06** 6,5 cm, 2 1/2"

**LANGENBECK**

**10-332-01** 5,5 cm, 2 1/8"

**LANGENBECK**

**10-332-02** 5,5 cm, 2 1/8"



Knorpelmesser  
Cartilage knife  
Cuchillo para cartilago  
Coltello per cartilagini

**10-334-01** 5,5 cm, 2 1/8 "



Knorpelmesser  
Cartilage knife  
Cuchillo para cartilago  
Coltello per cartilagini

**10-334-02** 7,0 cm, 2 3/4 "



Knorpelmesser  
Cartilage knife  
Cuchillo para cartilago  
Coltello per cartilagini

**10-336-01** 5,5 cm, 2 1/8 "



Seziermesser  
Autopsy knife  
Cuchillo para autopsia  
Coltello per autopsie

**VIRCHOW**

**10-338-08** 8,5 cm, 3 3/8 "



Seziermesser  
Autopsy knife  
Cuchillo para autopsia  
Coltello per autopsie

**VIRCHOW**

**10-340-09** 9,5 cm, 3 3/8 "



Seziermesser  
Autopsy knife  
Cuchillo para autopsia  
Coltello per autopsie

**10-340-11** 11,5 cm, 4 1/4 "



Seziermesser  
Autopsy knife  
Cuchillo para autopsia  
Coltello per autopsie

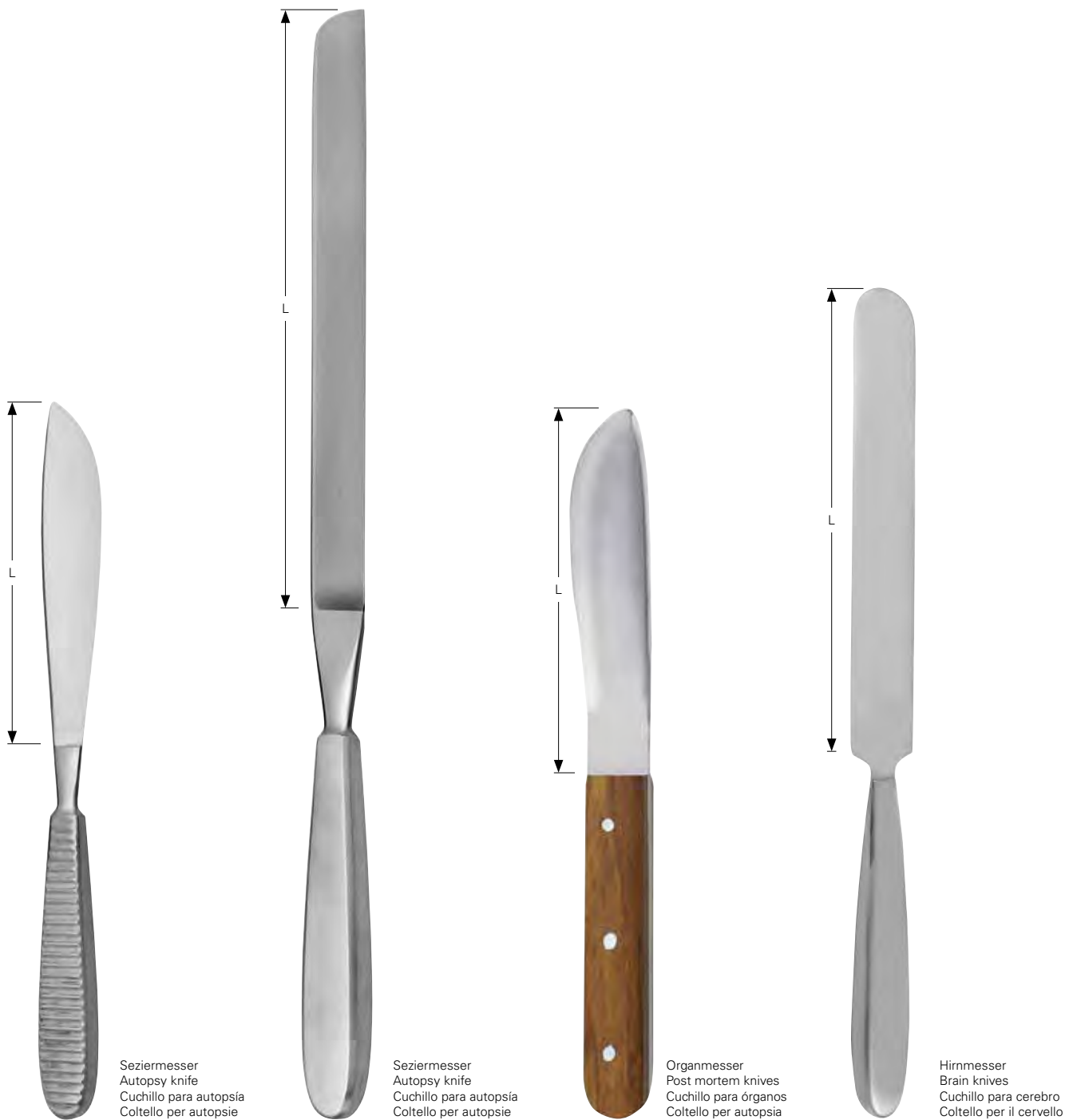
**10-342-08** 8,0 cm, 3 1/8 "



Seziermesser  
Autopsy knife  
Cuchillo para autopsia  
Coltello per autopsie

**10-344-10** 10,0 cm, 4 "





Seziermesser  
 Autopsy knife  
 Cuchillo para autopsia  
 Coltello per autopsie

Seziermesser  
 Autopsy knife  
 Cuchillo para autopsia  
 Coltello per autopsie

Organmesser  
 Post mortem knives  
 Cuchillo para órganos  
 Coltello per autopsia

Hirnmesser  
 Brain knives  
 Cuchillo para cerebro  
 Coltello per il cervello

**WALB**

**VIRCHOW**

**10-344-13** 13,0 cm, 5 1/8"

**10-344-19** 19,5 cm, 7 3/4"

**10-350-11** 11,0 cm, 4 3/8"  
**10-350-14** 14,0 cm, 5 1/2"  
**10-350-17** 17,0 cm, 6 3/4"

**10-360-16** 16,0 cm, 6 1/4"  
**10-360-20** 20,0 cm, 8"  
**10-360-24** 24,0 cm, 9 1/2"



Fig. 1

**10-362-01**



Fig. 2

**10-362-02**



Fig. 3

**10-362-03**

Fistelmesser  
Fistula knives  
Bisturie para fistulas  
Bisturi per fistole

**SIMON**

**10-362-01 - 10-362-03** 20,0 cm, 8"



Fistelmesser  
Fistula knife  
Bisturie para fistulas  
Bisturi per fistole

**ULRICH**

**10-364-22** 22,5 cm, 9"



**10-365-23**

Konisationsmesser  
Cone knife  
Bisturie para cono  
Bisturi per cono

**AYRE**

**10-365-23** 23,5 cm, 9 1/4"



**10-366-22**

Fistelmesser  
Fistula knife  
Bisturie para fistulas  
Bisturi per fistole

**SCHROEDER**

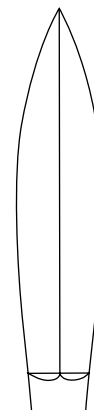
**10-366-22** 22,0 cm, 8 3/8"



**10-367-23**

Konisationsmesser  
Cone knife  
Bisturie para cono  
Bisturi per cono

**10-367-23** 23,0 cm, 9"

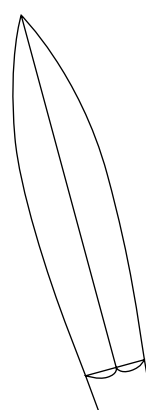


**10-368-26**

Myommesser  
Myoma knife  
Bisturie para fibroma  
Bisturi per fibromi

**SEGOND**

**10-368-26 - 10-368-27** 27,0 cm, 10 3/4"



**10-368-27**



Trigeminusmesser  
 Trigeminal knife  
 Bisturie para nervo trigemino  
 Bisturi per nervo trgémino

### OLIVECRONA

**10-369-20** 20,5 cm, 8"



Tonsillenmesser  
 Tonsil knife  
 Bisturie para amígdalas  
 Bisturi per tonsille

### FOWLER

**10-371-20** 20,0 cm, 8"



Tonsillenmesser  
 Tonsil knife  
 Bisturie para amígdalas  
 Bisturi per tonsille

### ABRAHAM

**10-371-21** 21,5 cm, 8 ½"



Tonsillenmesser  
 Tonsil knife  
 Bisturie para amígdalas  
 Bisturi per tonsille

### BRUENINGS

**10-371-22** 21,5 cm, 8 ½"



**10-374-13**

Abszessmesser  
 Abscess knife  
 Bisturie para absceso  
 Bisturi per ascesso

**10-374-13** 13,0 cm, 5 ⅛"



Fig. 1

**10-378-01**



Fig. 2

**10-378-02**



Fig. 3

**10-378-03**

Duramesser  
 Dura knives  
 Bisturie para dura-madré  
 Bisturi per dura-madre

### ZIEGLER

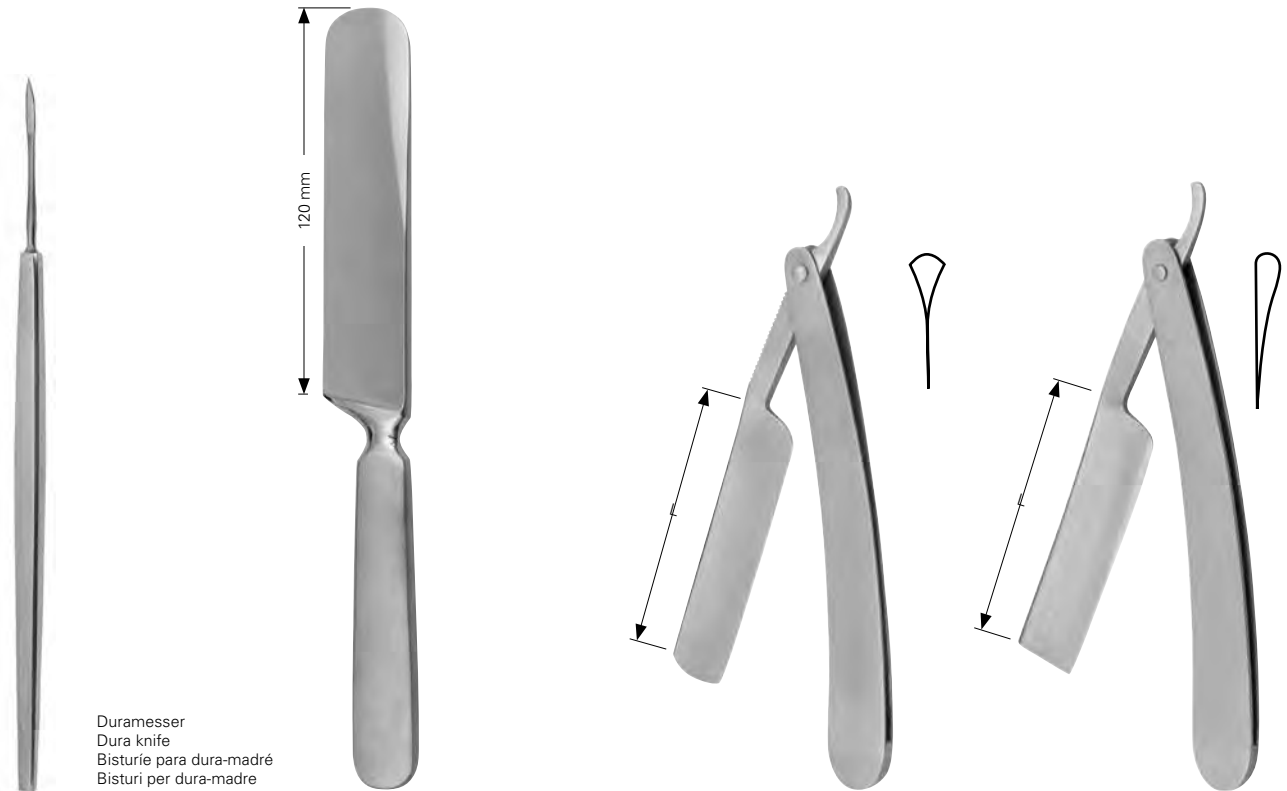
**10-378-01 - 10-378-03** 12,0 cm, 4 ¾"



Duramesser  
 Dura knife  
 Bisturie para dura-madré  
 Bisturi per dura-madre

### TOENNIS

**10-380-13** 13,0 cm, 5 ⅛"



Duramesser  
Dura knife  
Bisturie para dura-madré  
Bisturi per dura-madre

**TOENNIS**

**10-380-19** 19,0 cm, 7 1/2"

**10-388-23** 23,0 cm, 9"

**10-390-00** 7,5 cm, 3"

**10-391-00** 8,0 cm, 3 1/8"



Abziehstein  
Sharpening stone  
Piedra afiladore  
Pietra per affilare

**ARKANSAS**

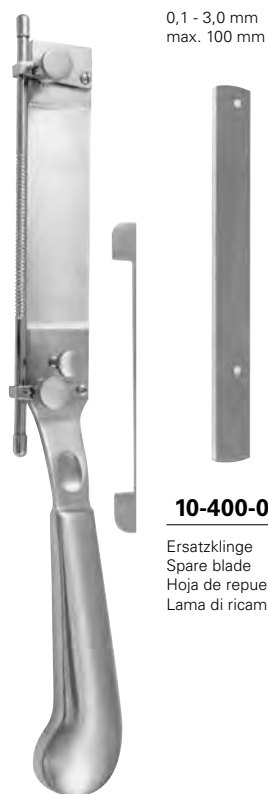
**10-398-00** 10,0 x 4,0 cm



Abziehstein  
Sharpening stone  
Piedra afiladore  
Pietra per affilare

**ARKANSAS**

**10-399-00** 15,0 x 5,0 cm



0,1 - 3,0 mm  
max. 100 mm

**10-400-01**

Ersatzklinge  
 Spare blade  
 Hoja de repuesto  
 Lama di ricambio

**SCHINK**

**10-400-00** 30,0 cm, 11 3/4"

Spannplatte  
 Skin graft plate  
 Placa para extender la piel  
 Placca per stendere la pelle



**SCHINK**

**10-400-02** 40 - 100 mm



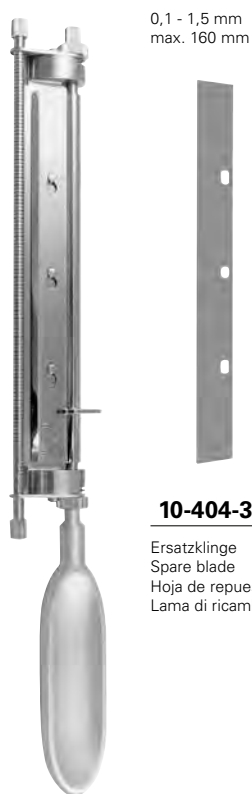
0,1 - 4,0 mm

**10-402-20**

Ersatzklinge  
 Spare blade  
 Hoja de repuesto  
 Lama di ricambio

**SILVER**

**10-402-19** 19,0 cm, 7 1/2"



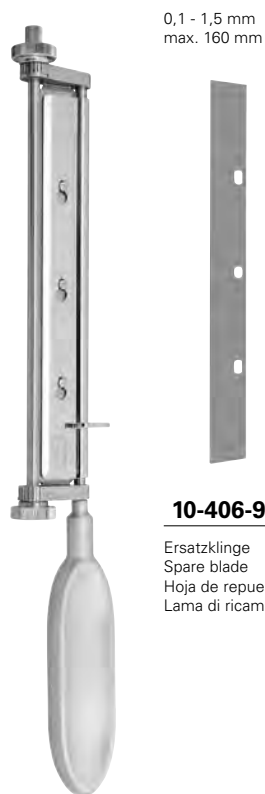
0,1 - 1,5 mm  
max. 160 mm

**10-404-32**

Ersatzklinge  
 Spare blade  
 Hoja de repuesto  
 Lama di ricambio

**HUMBY**

**10-404-31** 32,0 cm, 12"



0,1 - 1,5 mm  
max. 160 mm

**10-406-99**

Ersatzklinge  
 Spare blade  
 Hoja de repuesto  
 Lama di ricambio

**WATSON**

**10-406-30** 30,0 cm, 11 3/4"



0,1 - 1,5 mm  
max. 160 mm

**10-406-99**

Ersatzklinge  
 Spare blade  
 Hoja de repuesto  
 Lama di ricambio

**COBBETT**

**10-406-31** 32,0 cm, 12"



**10-411-14**

Lupusschaber  
Lupus scraper  
Rascador para lupus  
Raschiatoio per lupus

**VIDAL**

**10-411-14** 14,0 cm, 5 1/2"



0  
2,0 mm  
**10-412-02**

0  
3,0 mm  
**10-412-03**

0  
4,0 mm  
**10-412-04**

0  
5,0 mm  
**10-412-05**

0  
6,0 mm  
**10-412-06**

Lupusküretten  
Lupus curettes  
Curetas para lupus  
Curette per lupus

**FOX**

**10-412-02 - 10-412-06** 14,0 cm, 5 1/2"



Fig. 1

**10-414-01**



Fig. 2

**10-414-02**



Fig. 3

**10-414-03**



Fig. 4

**10-414-04**



Fig. 5

**10-414-05**



Fig. 6

**10-414-06**

Lupusküretten  
Lupus curettes  
Curetas para lupus  
Curette per lupus

**WOLFF**

**10-414-01 - 10-414-06** 14,0 cm, 5 1/2"



Ø 2,0 mm

**10-420-02**



Ø 3,0 mm

**10-420-03**



Ø 4,0 mm

**10-420-04**



Ø 5,0 mm

**10-420-05**



Ø 6,0 mm

**10-420-06**



Ø 7,0 mm

**10-420-07**



Ø 8,0 mm

**10-420-08**

Hauttrephine  
Dermal punch  
Trépanos para piel  
Trefine cutanee

**KEYES**

**10-420-02 - 10-420-08** 11,0 cm, 4 3/8"



Ø 2,0 mm      Ø 3,0 mm

Ø 4,0 mm      Ø 5,0 mm

Ø 6,0 mm      Ø 7,0 mm

Hauttrephine Set  
 Dermal punch set  
 Juego de trépanos para piel  
 Set per trephine cutanee



Komedoneninstrument  
 Comedone extractor  
 Extractore para comedones  
 Tiracomedoni

**UNNA**

**10-431-14** 14,5 cm, 5 3/4"



Komedoneninstrument  
 Comedone extractor  
 Extractore para comedones  
 Tiracomedoni

**UNNA**

**10-433-14** 14,5 cm, 5 3/4"



Komedoneninstrument  
 Comedone extractor  
 Extractore para comedones  
 Tiracomedoni

**SAALFELD**

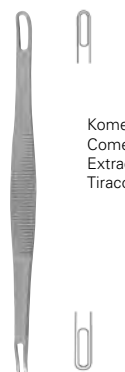
**10-435-11** 11,0 cm, 4 3/8"



Komedoneninstrument  
 Comedone extractor  
 Extractore para comedones  
 Tiracomedoni

**SAALFELD**

**10-437-14** 14,5 cm, 5 3/4"



Komedoneninstrument  
 Comedone extractor  
 Extractore para comedones  
 Tiracomedoni

**SCHAMBERG**

**10-439-09** 9,5 cm, 3 3/4"



Komedoneninstrument  
 Comedone extractor  
 Extractore para comedones  
 Tiracomedoni

**KATSCH**

**10-441-14** 14,0 cm, 5 1/2"



Komedoneninstrument  
 Comedone extractor  
 Extractore para comedones  
 Tiracomedoni

**UNNA-VIDAL**

**10-446-11** 11,5 cm, 4 1/2"



Ø 1,0 mm



Ø 1,5 mm



Ø 2,0 mm



Ø 2,0 mm

mit Ohr  
with eye  
con ojete  
con occhiello

<b>10-600-11</b>	11,5 cm, 4 1/2"
<b>10-600-13</b>	13,0 cm, 5 1/8"
<b>10-600-14</b>	14,5 cm, 5 3/4"
<b>10-600-16</b>	16,0 cm, 6 1/4"
<b>10-600-18</b>	18,0 cm, 7"
<b>10-600-20</b>	20,0 cm, 8"
<b>10-600-25</b>	25,0 cm, 9 3/4"

<b>10-601-11</b>	11,5 cm, 4 1/2"
<b>10-601-13</b>	13,0 cm, 5 1/8"
<b>10-601-14</b>	14,5 cm, 5 3/4"
<b>10-601-16</b>	16,0 cm, 6 1/4"
<b>10-601-18</b>	18,0 cm, 7"
<b>10-601-20</b>	20,0 cm, 8"
<b>10-601-25</b>	25,0 cm, 9 3/4"

<b>10-602-11</b>	11,5 cm, 4 1/2"
<b>10-602-13</b>	13,0 cm, 5 1/8"
<b>10-602-14</b>	14,5 cm, 5 3/4"
<b>10-602-16</b>	16,0 cm, 6 1/4"
<b>10-602-18</b>	18,0 cm, 7"
<b>10-602-20</b>	20,0 cm, 8"
<b>10-602-25</b>	25,0 cm, 9 3/4"
<b>10-602-30</b>	30,0 cm, 11 3/4"

<b>10-604-11</b>	11,5 cm, 4 1/2"
<b>10-604-13</b>	13,0 cm, 5 1/8"
<b>10-604-14</b>	14,5 cm, 5 3/4"
<b>10-604-16</b>	16,0 cm, 6 1/4"
<b>10-604-18</b>	18,0 cm, 7"
<b>10-604-20</b>	20,0 cm, 8"



Ø 2,0 mm

Myrtenblattsonden  
Myrtle leaf probes  
Sonda de mirto  
Sonde a foglia di mirto

<b>10-606-13</b>	13,0 cm, 5 1/8"
<b>10-606-14</b>	14,5 cm, 5 3/4"
<b>10-606-16</b>	16,0 cm, 6 1/4"
<b>10-606-18</b>	18,0 cm, 7"
<b>10-606-20</b>	20,0 cm, 8"



**STACKE**

<b>10-608-10</b>	10,5 cm, 4 1/4"
------------------	-----------------



Tränenkanalsonden  
Lachrymal probes  
Estilete para el canal lacrimal  
Stilette per canale lacrimale



**BOWMAN**

<b>10-609-00</b>	Fig. 000/00
<b>10-609-01</b>	Fig. 00/0
<b>10-609-02</b>	Fig. 1/2
<b>10-609-03</b>	Fig. 3/4
<b>10-609-04</b>	Fig. 5/6
<b>10-609-05</b>	Fig. 7/8





Tränenkanalsonde  
 Lachrymal probe  
 Estilete para el canal lacrimal  
 Stilette per canale lacrimale

### CASTROVIEJO

**10-610-01** 14,0 cm, 5 1/2"



Tränenkanalsonden  
 Lachrymal probes  
 Estilete para el canal lacrimal  
 Stilette per canale lacrimale

### WILDER

**10-610-02 - 10-610-04** 10,0 cm, 4"



Fig. 1

**10-610-02**



Fig. 2

**10-610-03**



Fig. 3

**10-610-04**



Hohlsonden  
 Directors  
 Sondas acanaladas  
 Sonde scanalate

- 10-610-11** 11,5 cm, 4 1/2"
- 10-610-13** 13,0 cm, 5 1/8"
- 10-610-14** 14,5 cm, 5 3/4"
- 10-610-16** 16,0 cm, 6 1/4"
- 10-610-18** 18,0 cm, 7"
- 10-610-20** 20,0 cm, 8"



Hohlsonden  
 Directors  
 Sondas acanaladas  
 Sonde scanalate

- 10-612-11** 11,5 cm, 4 1/2"
- 10-612-13** 13,0 cm, 5 1/8"
- 10-612-14** 14,5 cm, 5 3/4"
- 10-612-16** 16,0 cm, 6 1/4"
- 10-612-18** 18,0 cm, 7"



Hohlsonde  
 Director  
 Sondas acanaladas  
 Sonde scanalate

### DOYEN

**10-613-14** 14,5 cm, 5 3/4"



Hohlsonde  
 Director  
 Sondas acanaladas  
 Sonde scanalate

### NÉLATON

**10-615-16** 16,0 cm, 6 1/4"



Hohlsonde  
Director  
Sondas acanaladas  
Sonde scanalate

**BRODIE**

**10-616-20** 20,0 cm, 8"



Fig. 1  
**10-617-01**



Fig. 2  
**10-617-02**



Fig. 3  
**10-617-03**

**PRATT**

**10-617-01 - 10-617-03** 21,0 cm, 8 ¼"



**10-618-16**



**10-619-16**



**10-621-16**



**10-623-16**

**LOCKHART-MUMMERY**

**10-618-16 - 10-623-16** 16,0 cm, 6 ¼"



dreikant gerieft  
triangular serrated  
estriadura triangular  
zigrinatura triangolare

### FARRELL

<b>10-630-12</b>	Ø 0,9 x 12,0 cm
<b>10-630-14</b>	Ø 0,9 x 14,0 cm
<b>10-630-16</b>	Ø 1,1 x 16,0 cm
<b>10-630-18</b>	Ø 1,2 x 18,0 cm



spiralförmig gerieft  
spirally serrated  
estriadura espiral  
zigrinatura spiraliforme

### FARRELL

<b>10-631-12</b>	Ø 0,9 x 12,0 cm
<b>10-631-14</b>	Ø 0,9 x 14,0 cm
<b>10-631-16</b>	Ø 1,1 x 16,0 cm
<b>10-631-18</b>	Ø 1,2 x 18,0 cm



spiralförmig gerieft  
spirally serrated  
estriadura espiral  
zigrinatura spiraliforme

### MARTIN

<b>10-632-12</b>	Ø 1,2 x 12,0 cm
<b>10-632-14</b>	Ø 1,2 x 14,0 cm
<b>10-632-16</b>	Ø 1,2 x 16,0 cm
<b>10-632-22</b>	Ø 1,5 x 12,0 cm
<b>10-632-24</b>	Ø 1,5 x 14,0 cm
<b>10-632-26</b>	Ø 1,5 x 16,0 cm
<b>10-632-28</b>	Ø 1,5 x 18,0 cm



dreikant gerieft  
triangular serrated  
estriadura triangular  
zigrinatura triangolare

### MARTIN

<b>10-633-12</b>	Ø 1,5 x 12,0 cm
<b>10-633-14</b>	Ø 1,5 x 14,0 cm
<b>10-633-16</b>	Ø 1,5 x 16,0 cm
<b>10-633-18</b>	Ø 1,5 x 18,0 cm



gerieft  
serrated  
estriadura  
zigrinatura

### JOBSON-HORNE

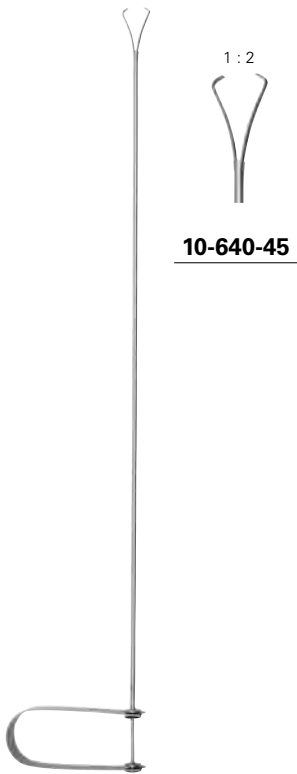
<b>10-634-14</b>	Ø 1,5 x 14,0 cm
<b>10-636-18</b>	Ø 1,5 x 18,0 cm



spiralförmig gerieft  
spirally serrated  
estriadura espiral  
zigrinatura spiraliforme

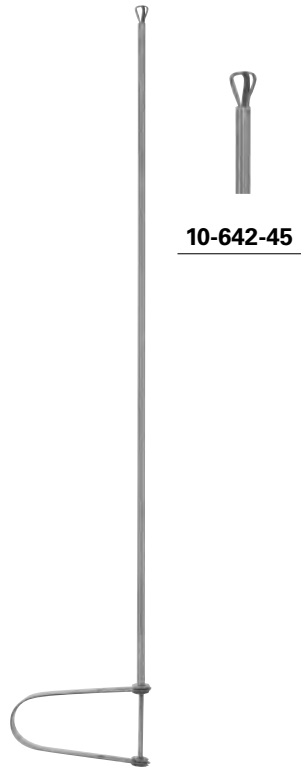
### UCKERMANN

<b>10-638-15</b>	Ø 1,2 x 15,0 cm
------------------	-----------------



**10-640-45**

**10-640-45** 45,0 cm, 18 "



**10-642-45**

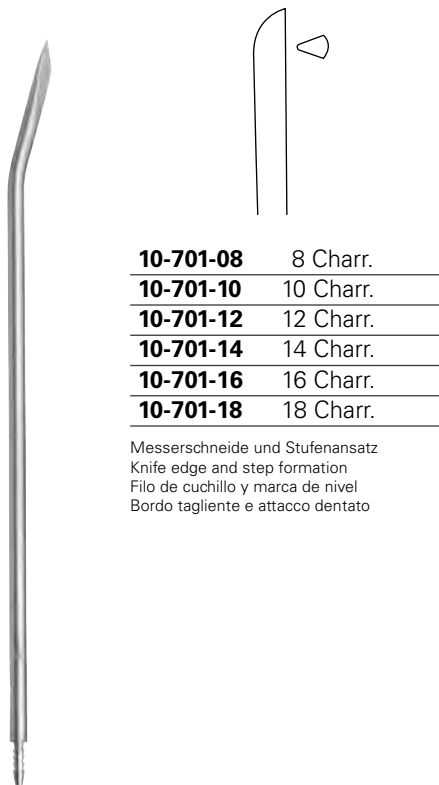
**EDER**

**10-642-45** 45,0 cm, 18 "



Pflasterspatel  
Plaster spatula  
Espátulas para emplasto  
Spatole per impiastro

**10-646-13** 13,0 cm, 5 1/8 "  
**10-646-14** 14,5 cm, 5 3/4 "



- 10-701-08** 8 Charr.
- 10-701-10** 10 Charr.
- 10-701-12** 12 Charr.
- 10-701-14** 14 Charr.
- 10-701-16** 16 Charr.
- 10-701-18** 18 Charr.

Messerschneide und Stufenansatz  
Knife edge and step formation  
Filo de cuchillo y marca de nivel  
Bordo tagliente e attacco dentato

**REDON**

**10-701-08 - 10-701-18** 19,5 cm, 7 3/4 "

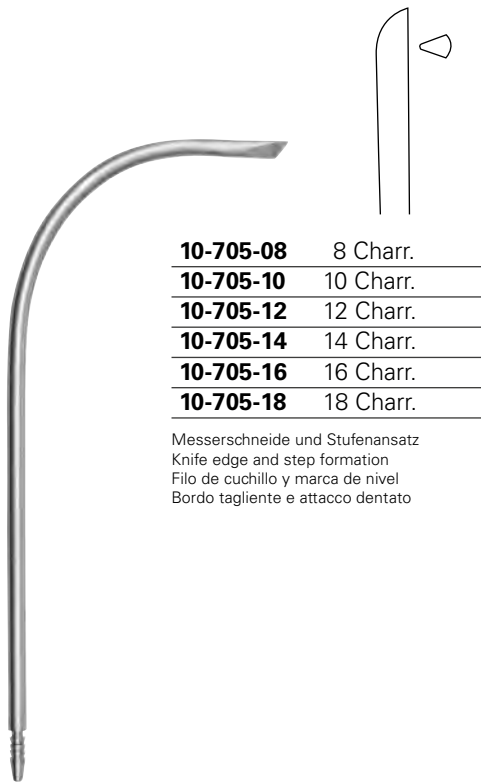


- 10-701-08 G** 8 Charr.
- 10-701-10 G** 10 Charr.
- 10-701-12 G** 12 Charr.
- 10-701-14 G** 14 Charr.
- 10-701-16 G** 16 Charr.
- 10-701-18 G** 18 Charr.

Messerschneide und Schraubgewinde  
Knife edge and thread end  
Filo de cuchillo y roscade  
Bordo tagliente e filetto

**REDON**

**10-701-08 G - 10-701-18 G** 19,5 cm, 7 3/4 "

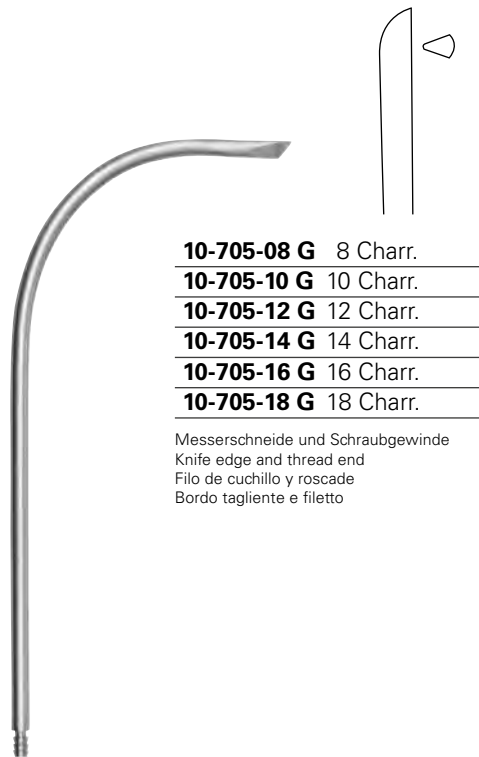


<b>10-705-08</b>	8 Charr.
<b>10-705-10</b>	10 Charr.
<b>10-705-12</b>	12 Charr.
<b>10-705-14</b>	14 Charr.
<b>10-705-16</b>	16 Charr.
<b>10-705-18</b>	18 Charr.

Messerschneide und Stufenansatz  
Knife edge and step formation  
Filo de cuchillo y marca de nivel  
Bordo tagliente e attacco dentato

## REDON

**10-705-08 - 10-705-18** 16,0 cm, 6 ¼"

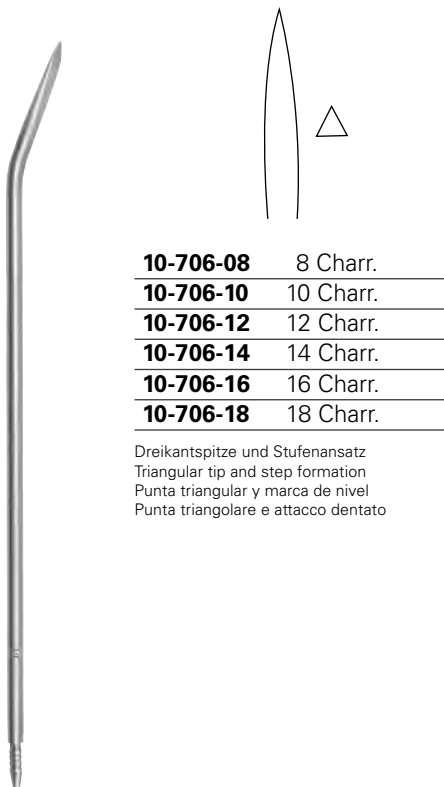


<b>10-705-08 G</b>	8 Charr.
<b>10-705-10 G</b>	10 Charr.
<b>10-705-12 G</b>	12 Charr.
<b>10-705-14 G</b>	14 Charr.
<b>10-705-16 G</b>	16 Charr.
<b>10-705-18 G</b>	18 Charr.

Messerschneide und Schraubgewinde  
Knife edge and thread end  
Filo de cuchillo y roscade  
Bordo tagliente e filetto

## REDON

**10-705-08 G - 10-705-18 G** 16,0 cm, 6 ¼"

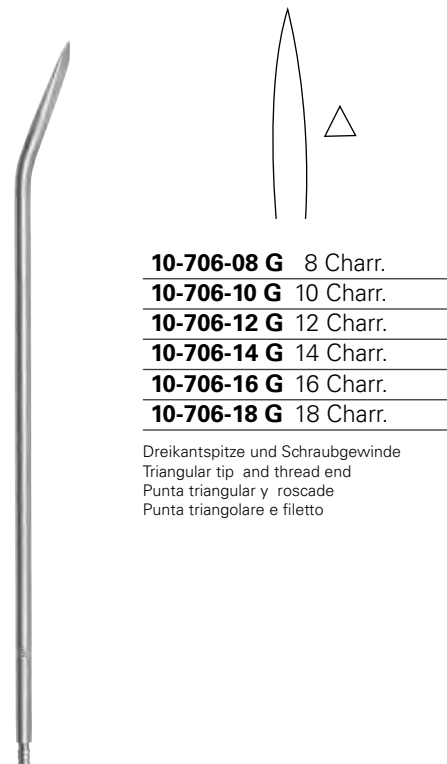


<b>10-706-08</b>	8 Charr.
<b>10-706-10</b>	10 Charr.
<b>10-706-12</b>	12 Charr.
<b>10-706-14</b>	14 Charr.
<b>10-706-16</b>	16 Charr.
<b>10-706-18</b>	18 Charr.

Dreikantspitze und Stufenansatz  
Triangular tip and step formation  
Punta triangular y marca de nivel  
Punta triangolare e attacco dentato

## REDON

**10-706-08 - 10-706-18** 19,5 cm, 7 ¾"

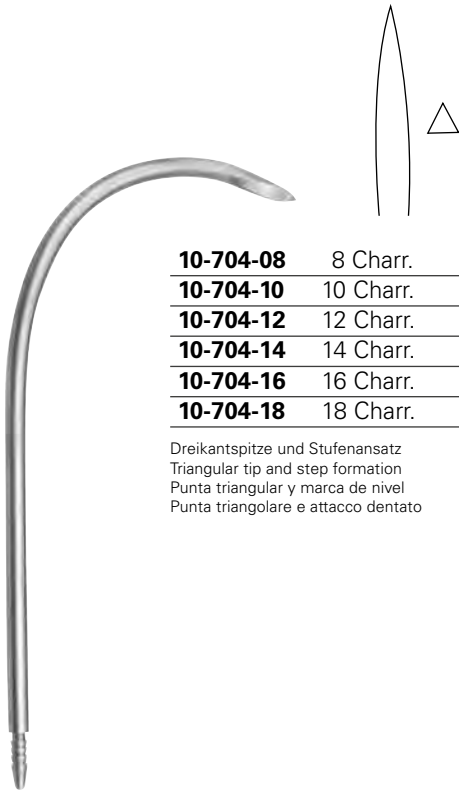


<b>10-706-08 G</b>	8 Charr.
<b>10-706-10 G</b>	10 Charr.
<b>10-706-12 G</b>	12 Charr.
<b>10-706-14 G</b>	14 Charr.
<b>10-706-16 G</b>	16 Charr.
<b>10-706-18 G</b>	18 Charr.

Dreikantspitze und Schraubgewinde  
Triangular tip and thread end  
Punta triangular y roscade  
Punta triangolare e filetto

## REDON

**10-706-08 G - 10-706-18 G** 19,5 cm, 7 ¾"



<b>10-704-08</b>	8 Charr.
<b>10-704-10</b>	10 Charr.
<b>10-704-12</b>	12 Charr.
<b>10-704-14</b>	14 Charr.
<b>10-704-16</b>	16 Charr.
<b>10-704-18</b>	18 Charr.

Dreikantsspitze und Stufenansatz  
Triangular tip and step formation  
Punta triangular y marca de nivel  
Punta triangolare e attacco dentato

**REDON**

**10-704-08 - 10-704-18** 16,0 cm, 6 ¼ "

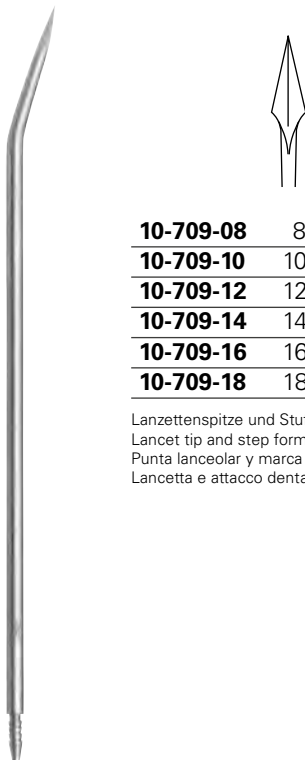


<b>10-704-08 G</b>	8 Charr.
<b>10-704-10 G</b>	10 Charr.
<b>10-704-12 G</b>	12 Charr.
<b>10-704-14 G</b>	14 Charr.
<b>10-704-16 G</b>	16 Charr.
<b>10-704-18 G</b>	18 Charr.

Dreikantsspitze und Schraubgewinde  
Triangular tip and thread end  
Punta triangular y roscade  
Punta triangolare e filetto

**REDON**

**10-704-08 G - 10-704-18 G** 16,0 cm, 6 ¼ "

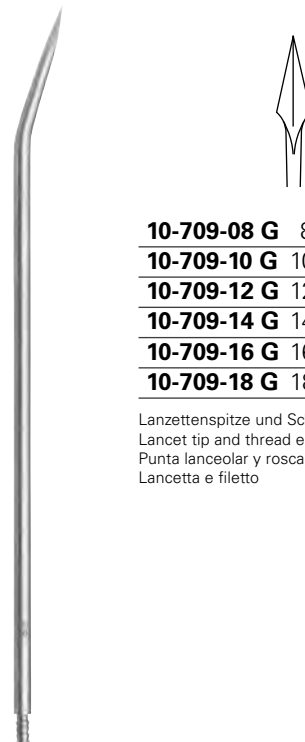


<b>10-709-08</b>	8 Charr.
<b>10-709-10</b>	10 Charr.
<b>10-709-12</b>	12 Charr.
<b>10-709-14</b>	14 Charr.
<b>10-709-16</b>	16 Charr.
<b>10-709-18</b>	18 Charr.

Lanzettenspitze und Stufenansatz  
Lancet tip and step formation  
Punta lanceolar y marca de nivel  
Lancetta e attacco dentato

**REDON**

**10-709-08 - 10-709-18** 19,5 cm, 7 ¾ "

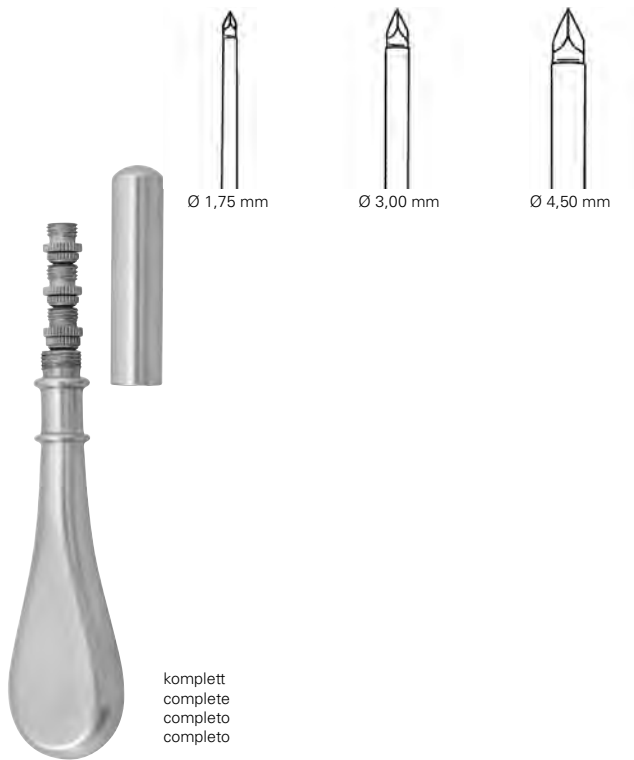


<b>10-709-08 G</b>	8 Charr.
<b>10-709-10 G</b>	10 Charr.
<b>10-709-12 G</b>	12 Charr.
<b>10-709-14 G</b>	14 Charr.
<b>10-709-16 G</b>	16 Charr.
<b>10-709-18 G</b>	18 Charr.

Lanzettenspitze und Schraubgewinde  
Lancet tip and thread end  
Punta lanceolar y roscade  
Lancetta e filetto

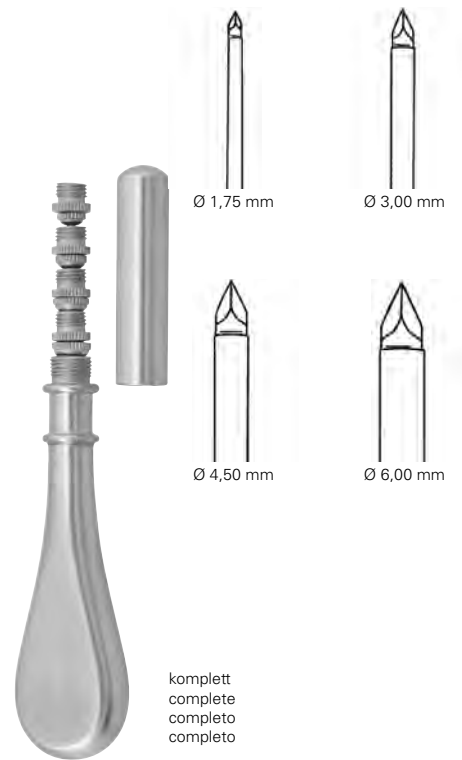
**REDON**

**10-709-08 G - 10-709-18 G** 19,5 cm, 7 ¾ "



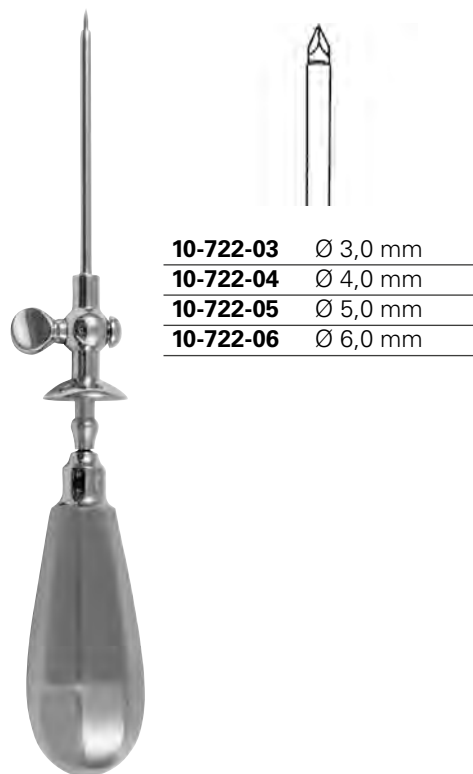
### UNIVERSAL

**10-720-03** 14,0 cm, 5 ½"



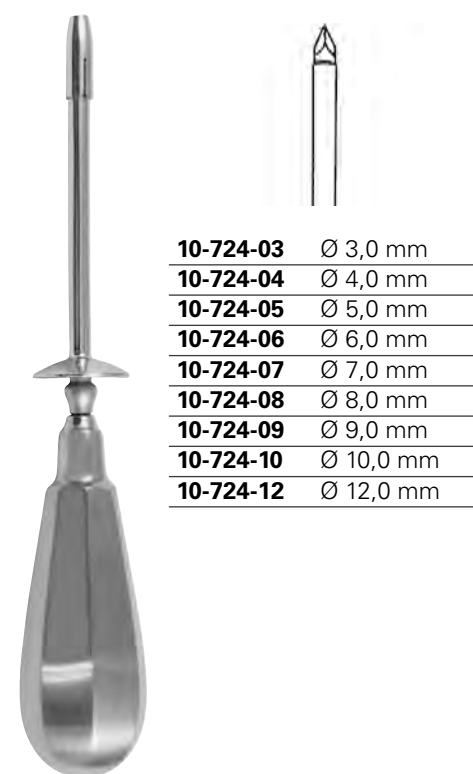
### UNIVERSAL

**10-720-04** 14,0 cm, 5 ½"



### STANDARD

**10-722-03 - 10-722-06** 12,0 cm, 4 ¾"



### NELSON

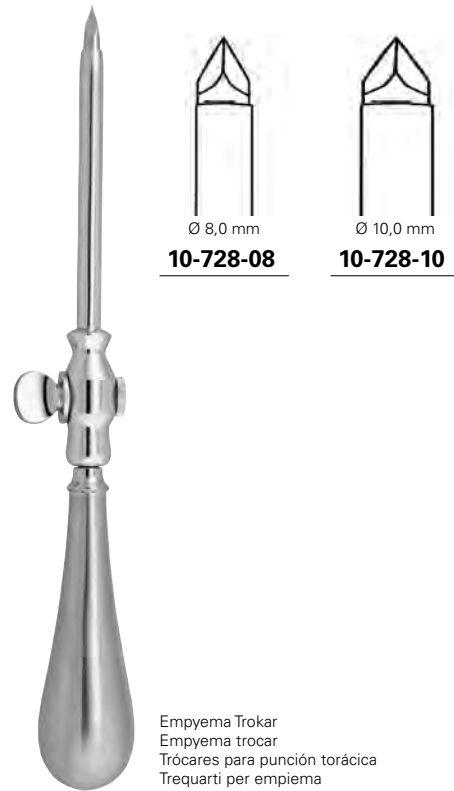
**10-724-03 - 10-724-12** 21,0 cm, 8 ¼"



Ø 4,5 mm  
**10-726-04**

**CARSTENS**

**10-726-04** Ø 4,5 mm



Ø 8,0 mm  
**10-728-08**

Ø 10,0 mm  
**10-728-10**

Empyema Trokar  
Empyema trocar  
Trócares para punción torácica  
Trequarti per empiema

**BUELAU**

**10-728-08 - 10-728-10** 21,0 cm, 9 ½"



**10-730-18** Ø 1,75 mm  
**10-730-20** Ø 2,00 mm  
**10-730-23** Ø 2,30 mm  
**10-730-24** Ø 2,70 mm

Kieferhöhlentroker  
Antrum trocar  
Cánula para punción del seno maxilar  
Trequarti per puntura del seno mascellare

**LICHTWITZ**

**10-730-18 - 10-730-24** 18,5 cm, 7 ¼"



**10-731-03** Ø 3,0 mm  
**10-731-04** Ø 4,0 mm  
**10-731-05** Ø 5,0 mm

Kieferhöhlentroker  
Antrum trocar  
Cánula para punción del seno maxilar  
Trequarti per puntura del seno mascellare

**PIERCE**

**10-731-03 - 10-731-05** 15,0 cm, 6"





Kieferhöhlentroker  
Antrum trocar  
Cánula para punción del seno maxilar  
Tre quarti per puntura del seno mascellare  
Ø 4,0 mm



### KRAUSE

**10-733-04** 16,0 cm, 6 ¼"



<b>10-736-40</b>	Ø 4,0 mm
<b>10-736-46</b>	Ø 4,6 mm
<b>10-736-53</b>	Ø 5,3 mm
<b>10-736-60</b>	Ø 6,0 mm

Gallenblasentroker  
Gall bladder trocar  
Trócares para vesícula biliar  
Tre quarti per vescia biliare



### OCHSNER

**10-736-40 - 10-736-60** 15,0 cm, 6"

Ø 5,5 mm



### DUKE

**10-734-05** 11,0 cm, 4 ½"



Ø 2,0 mm  
**10-738-02**

### LANDAU

**10-738-02** Ø 2,0 mm



Ø 3,0 mm  
**10-739-03**

Kieferhöhlentroker  
Antrum trocar  
Cánula para punción del seno maxilar  
Tre quarti per puntura del seno mascellare



### DOUGLAS

**10-739-03** 14,0 cm, 5 ½"



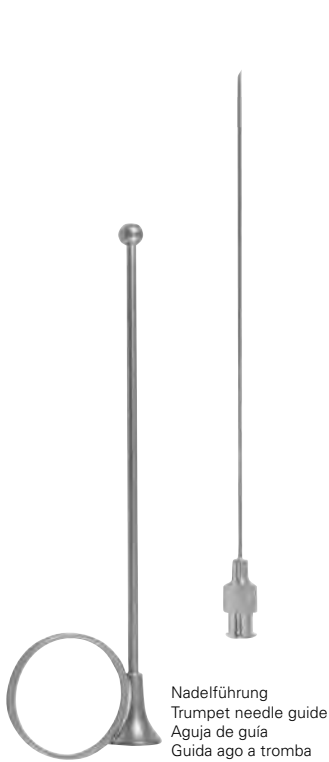
Ø 3,0 mm  
**10-741-03**

Kieferhöhlentroker  
Antrum trocar  
Cánula para punción del seno maxilar  
Tre quarti per puntura del seno mascellare



### COAKLEY

**10-741-03** 15,5 cm, 6"



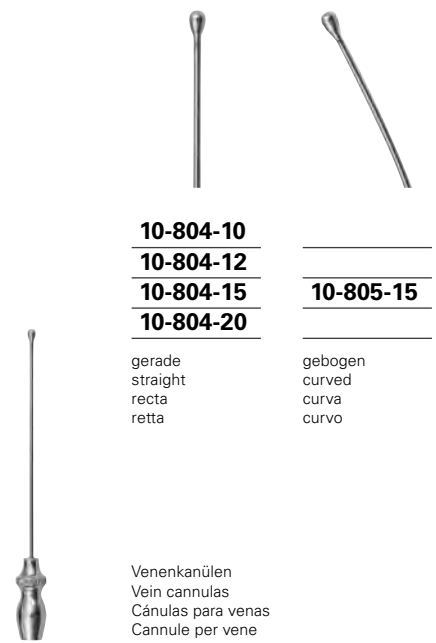
**IOWA**

**10-802-00** 14,0 cm, 5 ¼"

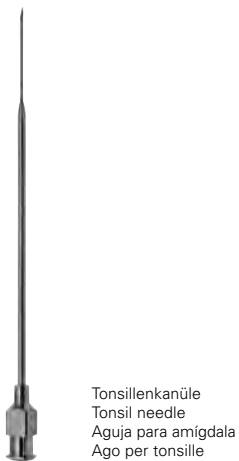


**IOWA**

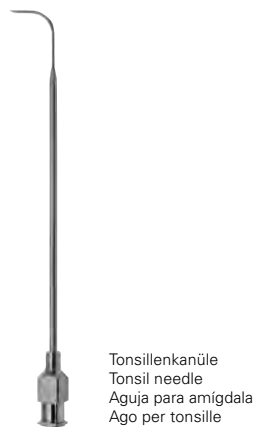
**10-802-01** 15,0 cm, 6"



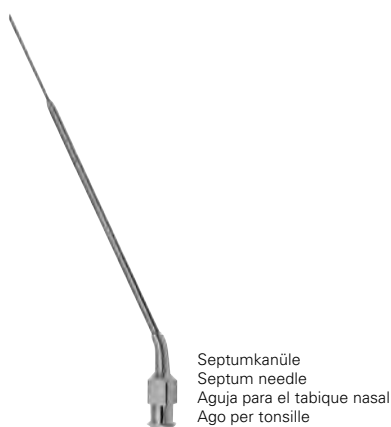
**10-804-10** Ø 1,0 x 60 mm  
**10-804-12** Ø 1,2 x 80 mm  
**10-804-15** Ø 1,5 x 80 mm  
**10-804-20** Ø 2,0 x 80 mm  
**10-805-15** Ø 1,5 x 80 mm



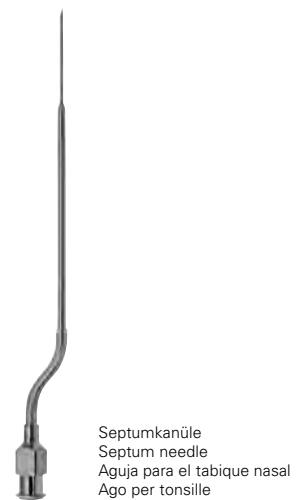
**10-810-01** Ø 0,8 x 100 mm



**10-810-02** Ø 0,8 x 80 mm



**10-810-03** Ø 0,8 x 107 mm



**10-810-04** Ø 0,8 x 140 mm



Insufflationskanülen  
 Insufflation cannulas  
 Cánulas para insuflación  
 Cannula per insufflazione

### VERRES

<b>10-812-08</b>	Ø 2,0 x 80 mm
<b>10-812-10</b>	Ø 2,0 x 100 mm
<b>10-812-12</b>	Ø 2,0 x 120 mm
<b>10-812-15</b>	Ø 2,0 x 150 mm
<b>10-812-17</b>	Ø 2,0 x 170 mm
<b>10-812-20</b>	Ø 2,0 x 200 mm

Kanüle zur Sternalpunktion  
 Sternum puncture needle  
 Agujas para punción del esternón  
 Aghi per la puntura dello sterno



### KLIMA-ROSEGGER

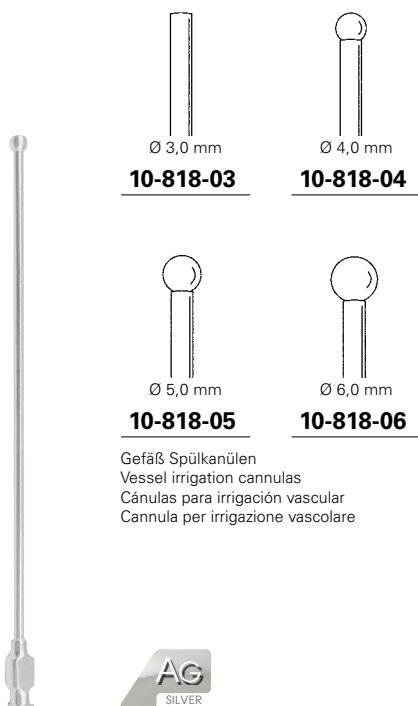
<b>10-815-18</b>	Ø 1,8 x 35 mm
------------------	---------------

Gefäß Spülkanülen  
 Vessel irrigation cannulas  
 Cánulas para irrigación vascular  
 Cannula per irrigazione vascolare



### VOLLMAR

<b>10-817-15</b>	Ø 1,5 x 60 mm
<b>10-817-20</b>	Ø 2,0 x 60 mm
<b>10-817-25</b>	Ø 2,5 x 60 mm
<b>10-817-30</b>	Ø 3,0 x 60 mm
<b>10-817-40</b>	Ø 4,0 x 60 mm



Ø 3,0 mm  
**10-818-03**

Ø 4,0 mm  
**10-818-04**

Ø 5,0 mm  
**10-818-05**

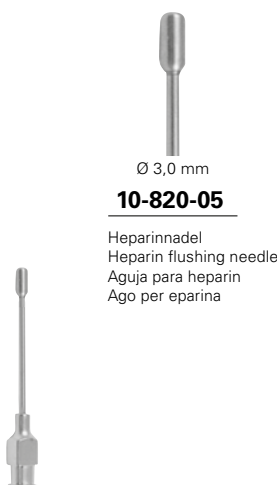
Ø 6,0 mm  
**10-818-06**

Gefäß Spülkanülen  
 Vessel irrigation cannulas  
 Cánulas para irrigación vascular  
 Cannula per irrigazione vascolare



### SCHMID

<b>10-818-03 - 10818-06</b>	15,0 cm, 5 7/8 "
-----------------------------	------------------



Ø 3,0 mm  
**10-820-05**

Heparinnadel  
 Heparin flushing needle  
 Aguja para heparin  
 Ago per eparina

### MOCK

<b>10-820-05</b>	4,5 cm, 1 3/4 "
------------------	-----------------



Ø 3,0 mm  
**10-820-06**

Heparinnadel  
 Heparin flushing needle  
 Aguja para heparin  
 Ago per eparina

### MOCK

<b>10-820-06</b>	6,0 cm, 2 1/2 "
------------------	-----------------

Kanülen für die Leberblindpunktion  
Liver blind puncture needles  
Agujas para la punción ciega del hígado  
Aghi per la puntura cieca del fegato



### MENGHINI

<b>10-822-10</b>	Ø 1,0 x 35 mm
<b>10-822-15</b>	Ø 1,0 x 70 mm
<b>10-822-20</b>	Ø 1,2 x 70 mm
<b>10-822-25</b>	Ø 1,2 x 100 mm
<b>10-822-30</b>	Ø 1,4 x 70 mm
<b>10-822-35</b>	Ø 1,4 x 100 mm
<b>10-822-40</b>	Ø 1,6 x 70 mm
<b>10-822-50</b>	Ø 1,8 x 100 mm

Kanülen zur gezielten Leberpunktion  
Needles for controlled liver puncture  
Agujas para la punción del hígado baja el control laparoscópico  
Aghi per la puntura controllata del fegato



### MENGHINI

<b>10-824-14</b>	Ø 1,4 x 168 mm
<b>10-824-18</b>	Ø 1,8 x 168 mm

Kanülen für die Lumbalpunktion  
Lumbar puncture needles  
Agujas para punción lumbar  
Aghi per punture lombari



### QUINKE

<b>10-828-01</b>	Ø 0,7 x 76 mm
<b>10-828-02</b>	Ø 0,7 x 89 mm
<b>10-828-03</b>	Ø 1,0 x 76 mm
<b>10-828-04</b>	Ø 1,0 x 89 mm
<b>10-828-05</b>	Ø 1,2 x 76 mm
<b>10-828-06</b>	Ø 1,2 x 89 mm



### LUER

<b>10-840-01</b>	1,0 ml
<b>10-840-02</b>	2,0 ml
<b>10-840-05</b>	5,0 ml
<b>10-840-10</b>	10,0 ml
<b>10-840-20</b>	20,0 ml
<b>10-840-50</b>	50,0 ml



### LUER-LOCK

<b>10-844-01</b>	1,0 ml
<b>10-844-02</b>	2,0 ml
<b>10-844-05</b>	5,0 ml
<b>10-844-10</b>	10,0 ml
<b>10-844-20</b>	20,0 ml
<b>10-844-50</b>	50,0 ml



### LUER-LOCK

<b>10-848-02</b>	2,0 ml
<b>10-848-05</b>	5,0 ml
<b>10-848-10</b>	10,0 ml
<b>10-848-20</b>	20,0 ml

Zylinder für 10-848-02 - 10-848-20  
Barrels for 10-848-02 - 10-848-20  
Cilindros para 10-848-02 - 10-848-20  
Cilindri per 10-848-02 - 10-848-20



### LUER-LOCK

<b>10-849-02</b>	2,0 ml
<b>10-849-05</b>	5,0 ml
<b>10-849-10</b>	10,0 ml
<b>10-849-20</b>	20,0 ml



Luftbläser, komplett  
Air blower, complete  
Jeringas para aire, completo  
Siringhe per aria, completo



**10-850-00**

Luftbläser  
Air blower  
Jeringas para aire  
Siringhe per aria



**10-850-02**

Kanüle  
Needle  
Aguja  
Aghi



**10-850-01**



Wund- und Blasenspritzen mit 1 konischen und 1 olivenförmigen Ansatz  
Wound and bladder syringes with 1 conical and 1 bulbous tip  
Jeringas para enjuagar la vejiga y heridas con 1 punta cónica y 1 punta forma oliva  
Siringhe per ferite e vescica con 1 punta conica e 1 punta oliva

**JANET**

<b>10-860-05</b>	50,0 ml
<b>10-860-10</b>	100,0 ml
<b>10-860-15</b>	150,0 ml
<b>10-860-20</b>	200,0 ml



Wund- und Blasenspritzen mit 1 konischen und 1 olivenförmigen Ansatz  
Wound and bladder syringes with 1 conical and 1 bulbous tip  
Jeringas para enjuagar la vejiga y heridas con 1 punta cónica y 1 punta forma oliva  
Siringhe per ferite e vescica con 1 punta conica e 1 punta oliva

**JANET-G**

<b>10-863-05</b>	50,0 ml
<b>10-863-10</b>	100,0 ml
<b>10-863-15</b>	150,0 ml
<b>10-863-20</b>	200,0 ml

Zylinder für 10-860-05 - 10-860-20  
Barrels for 10-860-05 - 10-860-20  
Cilindros para 10-860-05 - 10-860-20  
Cilindri per 10-860-05 - 10-860-20



**JANET**

<b>10-862-05</b>	50,0 ml
<b>10-862-10</b>	100,0 ml
<b>10-862-15</b>	150,0 ml
<b>10-862-20</b>	200,0 ml



Wund- und Blasenspritzen mit 1 konischen und 1 olivenförmigen Ansatz  
Wound and bladder syringes with 1 conical and 1 bulbous tip  
Jeringas para enjuagar la vejiga y heridas con 1 punta cónica y 1 punta forma oliva  
Siringhe per ferite e vescica con 1 punta conica e 1 punta oliva

Zylinder für 10-864-05 - 10-864-25  
Barrels for 10-864-05 - 10-864-25  
Cilindros para 10-864-05 - 10-864-25  
Cilindri per 10-864-05 - 10-864-25



### JANET-GS

<b>10-864-05</b>	50,0 ml
<b>10-864-07</b>	75,0 ml
<b>10-864-10</b>	100,0 ml
<b>10-864-15</b>	150,0 ml
<b>10-864-20</b>	200,0 ml
<b>10-864-25</b>	250,0 ml

### JANET-GS

<b>10-866-05</b>	50,0 ml
<b>10-866-07</b>	75,0 ml
<b>10-866-10</b>	100,0 ml
<b>10-866-15</b>	150,0 ml
<b>10-866-20</b>	200,0 ml
<b>10-866-25</b>	250,0 ml



Ansatz  
Tip  
Punta  
Punta

### JANET-GS

**10-864-99**

Kehlkopf-Spritzen mit Kanüle 10-871-99  
Laryngeal Syringes with cannula 10-871-99  
Jeringa de laringeos con aguja 10-871-99  
Siringa per laringei con aghi 10-871-99

Kehlkopf- Kanüle  
Laryngeal cannula  
Aguja para laringeos  
Aghi per laringei



### LUER-LOCK

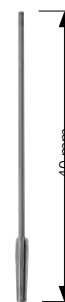
<b>10-871-02</b>	2,0 ml
<b>10-871-05</b>	5,0 ml
<b>10-871-10</b>	10,0 ml

### LUER-LOCK

**10-871-99**



Mikro Absaugrohr komplett, bestened aus:  
Micro suction tube complete, consisting of:  
Aspirador micro, completo, compuesto de:  
Micro tubo aspirazione, completo, composta da:  
10-900-01 | 10-900-04 - 10-900-08



### WULLSTEIN

**10-900-00** 14,0 cm, 5 1/2"

### WULLSTEIN

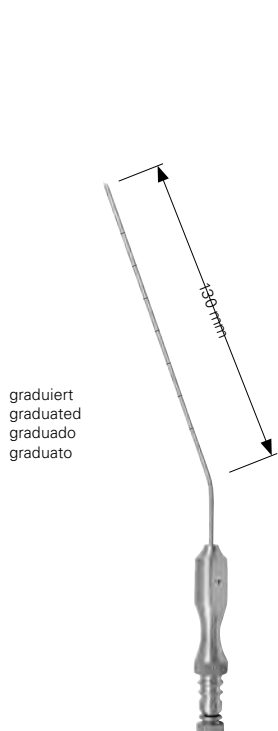
**10-900-01** 14,0 cm, 5 1/2"

### WULLSTEIN

**10-900-04** Ø 0,4 mm

**10-900-06** Ø 0,6 mm

**10-900-08** Ø 0,8 mm

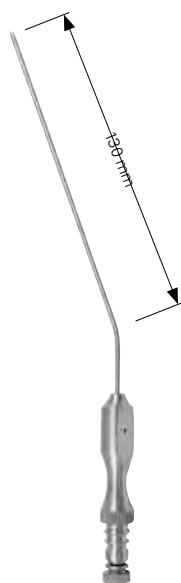


### FRAZIER

**10-901-05** 5 Charr.

**10-901-07** 7 Charr.

**10-901-09** 9 Charr.



### FRAZIER

**10-902-06** 6 Charr.

**10-902-07** 7 Charr.

**10-902-08** 8 Charr.

**10-902-09** 9 Charr.

**10-902-10** 10 Charr.

**10-902-11** 11 Charr.

**10-902-12** 12 Charr.

**10-902-15** 15 Charr.



### PLESTER

**10-903-05** 5 Charr.

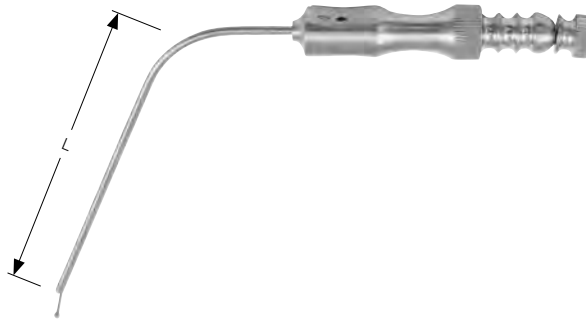
**10-903-06** 6 Charr.

**10-903-07** 7 Charr.

**10-903-08** 8 Charr.

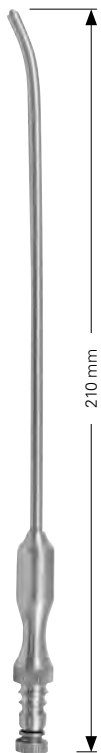
**10-903-09** 9 Charr.

**10-903-10** 10 Charr.



**FERGUSSON 90°**

Ø	Länge 110 mm Length 110 mm Longitud 110 mm Lunghezza 110 mm	Länge 130 mm Length 130 mm Longitud 130 mm Lunghezza 130 mm	Länge 160 mm Length 160 mm Longitud 160 mm Lunghezza 160 mm	Länge 200 mm Length 200 mm Longitud 200 mm Lunghezza 200 mm
4 Charr.	<b>10-904-04</b>			
5 Charr.	<b>10-904-05</b>	<b>10-904-25</b>	<b>10-904-45</b>	<b>10-904-65</b>
6 Charr.	<b>10-904-06</b>	<b>10-904-26</b>	<b>10-904-46</b>	<b>10-904-66</b>
7 Charr.	<b>10-904-07</b>			
8 Charr.	<b>10-904-08</b>	<b>10-904-28</b>	<b>10-904-48</b>	<b>10-904-68</b>
9 Charr.	<b>10-904-09</b>	<b>10-904-29</b>	<b>10-904-49</b>	<b>10-904-69</b>
10 Charr.	<b>10-904-10</b>			
11 Charr.	<b>10-904-11</b>			
12 Charr.	<b>10-904-12</b>	<b>10-904-32</b>	<b>10-904-52</b>	<b>10-904-72</b>
15 Charr.	<b>10-904-15</b>	<b>10-904-35</b>	<b>10-904-55</b>	<b>10-904-75</b>

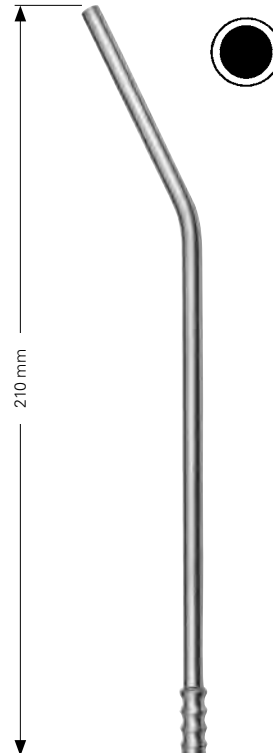


**ADSON**

**10-905-04** Ø 4,0 mm  
**10-905-05** Ø 5,0 mm

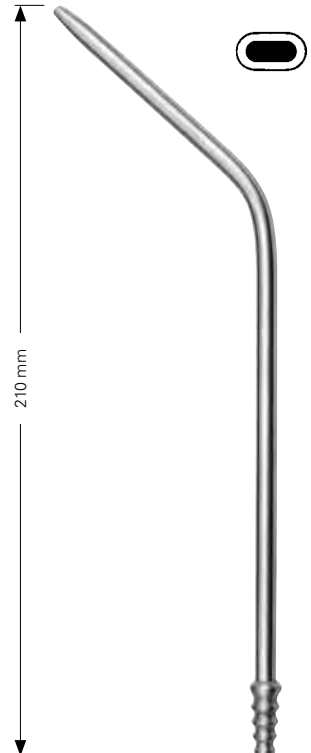


**10-906-05** Ø 5,0 mm



**NUBOER**

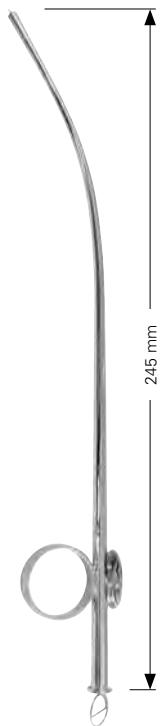
**10-906-06** Ø 6,0 mm



**NUBOER**

**10-906-07** Ø 6,0 mm





### MAGILL

**10-906-30** Ø 3,0 mm

**10-906-35** Ø 3,5 mm

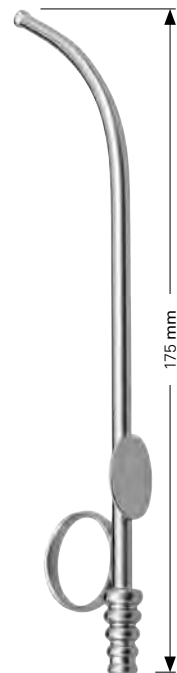
**10-906-40** Ø 4,0 mm



Reinigungsdraht  
Stilette  
Alambre de limpieza  
Filo per la pulitura

### MAGILL

**10-906-99**



**10-906-55** Ø 5,5 mm



isoliert  
insulated  
aislada  
isolato

### FERGUSON 85°

**10-907-00** Ø 4,0 mm



### FERGUSON 85°

**10-907-01** 6 Charr.

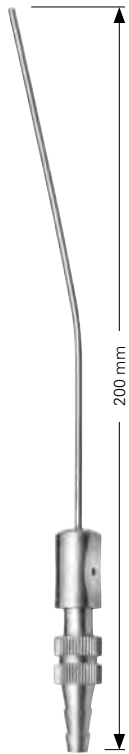
**10-907-02** 8 Charr.

**10-907-03** 9 Charr.

**10-907-04** 10 Charr.

**10-907-05** 12 Charr.

**10-907-06** 15 Charr.



**LEMPERT**

<b>10-908-07</b>	Ø 2,0 mm
<b>10-908-09</b>	Ø 3,0 mm

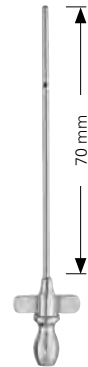
Hirnventrikelpunktionskanülen  
Ventricel of cerebrum puncture cannulas  
Cánulas para la punción del ventriculo cerebral  
Cannule per la puntura del ventricolo cerebrale



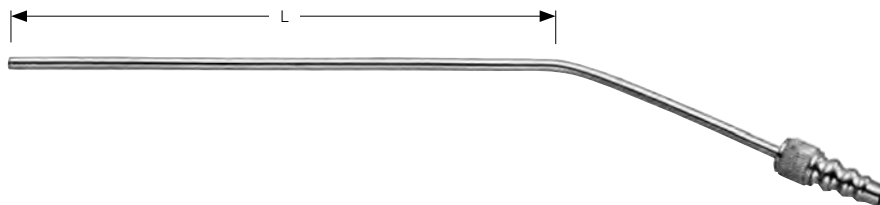
**FRAZIER**

<b>10-908-25</b>	Ø 2,5 mm
<b>10-908-30</b>	Ø 3,0 mm

Hirnventrikelpunktionskanülen  
Ventricel of cerebrum puncture cannulas  
Cánulas para la punción del ventriculo cerebral  
Cannule per la puntura del ventricolo cerebrale



<b>10-909-20</b>	Ø 2,0 mm
<b>10-909-25</b>	Ø 2,5 mm



**YASARGIL**

Ø	Länge 130 mm Length 130 mm Longitud 130 mm Lunghezza 130 mm	Länge 150 mm Length 150 mm Longitud 150 mm Lunghezza 150 mm	Länge 180 mm Length 180 mm Longitud 180 mm Lunghezza 180 mm	Länge 220 mm Length 220 mm Longitud 220 mm Lunghezza 220 mm
Ø 1,5 mm	<b>10-910-15</b>	<b>10-910-16</b>	<b>10-910-17</b>	<b>10-910-18</b>
Ø 2,0 mm	<b>10-910-20</b>	<b>10-910-21</b>	<b>10-910-22</b>	<b>10-910-23</b>
Ø 2,5 mm	<b>10-910-24</b>	<b>10-910-25</b>	<b>10-910-26</b>	<b>10-910-27</b>
Ø 3,5 mm	<b>10-910-33</b>	<b>10-910-35</b>	<b>10-910-36</b>	<b>10-910-37</b>
Ø 4,5 mm			<b>10-910-45</b>	



**YANKAUER**

**10-911-01** 27,0 cm, 10 3/4 "



**YANKAUER**

**10-911-02** 27,0 cm, 10 3/4 "



Olive  
Olive  
Oliva  
Oliva

**YANKAUER**

**10-911-31**



**BABY-YANKAUER**

**10-911-03** 21,0 cm, 8 1/4 "



Olive  
Olive  
Oliva  
Oliva

**BABY-YANKAUER**

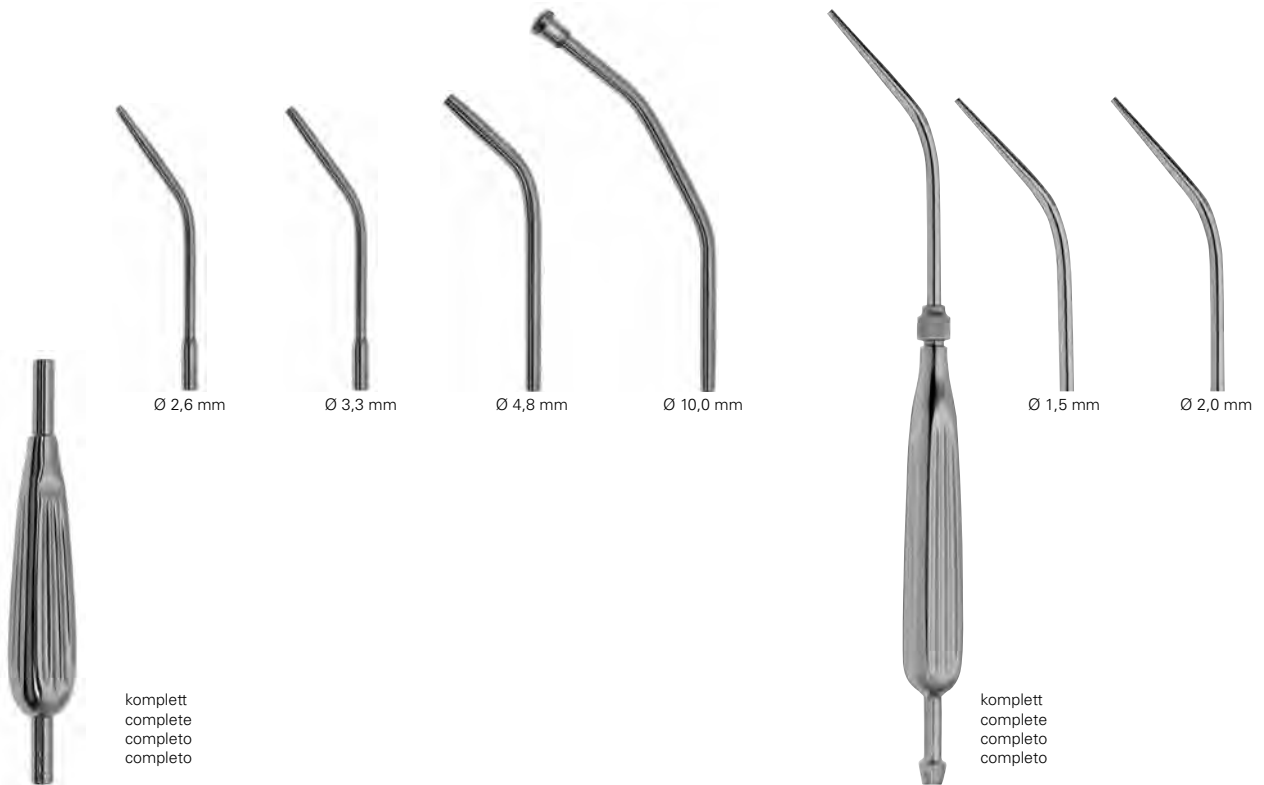
**10-911-32**



mit Absperrventil und  
abschraubbarem Rohr  
with stopcock and tube  
to be screwed off  
con interruptor y tubo  
desenroscable  
con interruttore e tubo  
svitabile

**WALTON-YANKAUER**

**10-911-04** 33,0 cm, 13 "



komplett  
complete  
completo  
completo

komplett  
complete  
completo  
completo

**YANKAUER**

**10-912-00** 27,0 cm, 10 3/4 "

**COUPLAND**

**10-913-00** 26,0 cm, 10 1/4 "

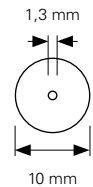


Ø 1,5 mm  
**10-913-15**

Ø 2,0 mm  
**10-913-20**

Ø 2,5 mm  
**10-913-25**

Ø 3,5 mm  
**10-913-35**



**COUPLAND**

**10-913-01** 17,0 cm, 6 3/4 "

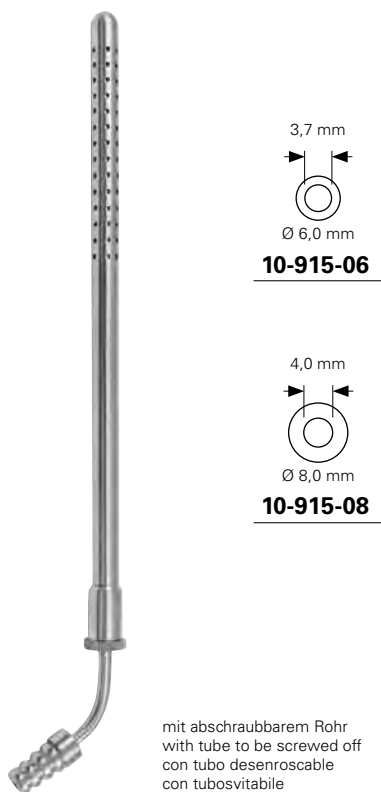
**COUPLAND**

**10-913-15 - 10-913-35** 10,0 cm, 4 "

**POOLE**

**10-914-10** 22,0 cm, 8 5/8 "

mit abschraubbarem Rohr  
with tube to be screwed off  
con tubo desenroscabile  
con tubosvitabile



**POOLE**

**10-915-06 - 10-915-08** 22,0 cm, 8 5/8 "



**COOLEY**

**10-917-08** 35,0 cm, 13 3/4 "



**COOLEY**

**10-919-10** 31,0 cm, 12 1/4 "



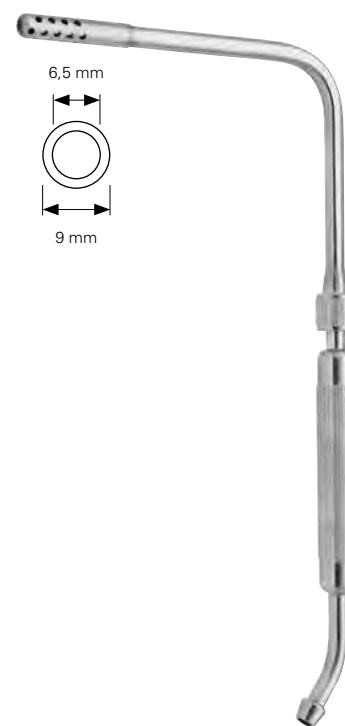
**COOLEY**

**10-921-07** 30,0 cm, 11 3/4 "



**COOLEY**

**10-923-08** 33,0 cm, 13 "



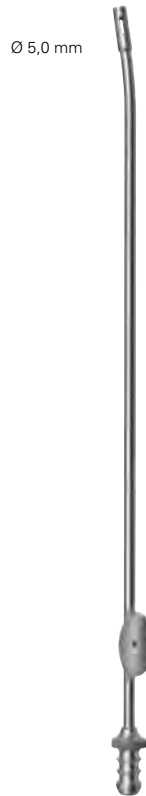
**COOLEY**

**10-925-09** 25,0 cm, 9 3/4 "



**DE BAKEY**

**10-931-16** 16,0 cm, 6 ¼"



**DE BAKEY**

**10-931-27** 27,0 cm, 10¾"



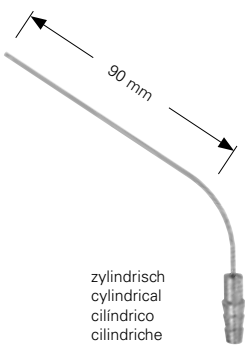
**DE BAKEY**

**10-935-27** 27,0 cm, 10¾"



**FINSTERER**

**10-937-32** 32,0 cm, 12 ½"

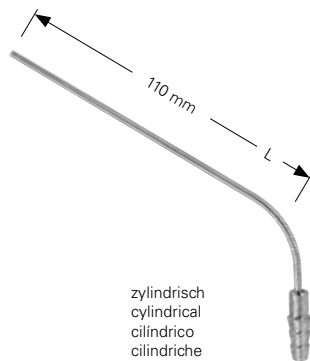


zylindrisch  
cylindrical  
cilindrico  
cilindriche

**10-940-10** Ø 1,0 mm

**10-940-15** Ø 1,5 mm

**10-940-20** Ø 2,0 mm



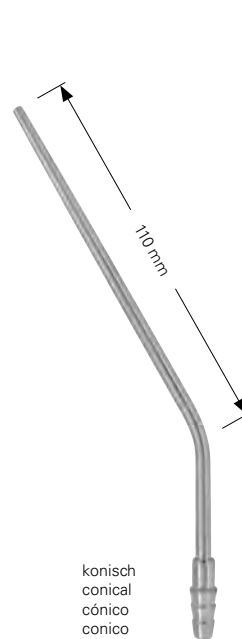
zylindrisch  
cylindrical  
cilindrico  
cilindriche

**10-940-25** Ø 2,5 mm

**10-941-30** Ø 3,0 mm

**10-941-40** Ø 4,0 mm

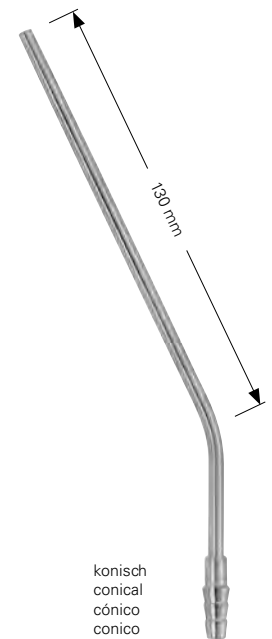
**10-941-50** Ø 5,0 mm



konisch  
conical  
cónico  
conico

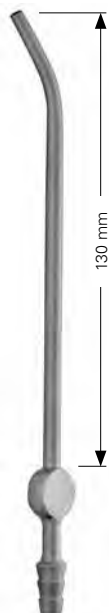
**10-942-03** Ø 3,0 mm

**10-942-04** Ø 3,5 mm



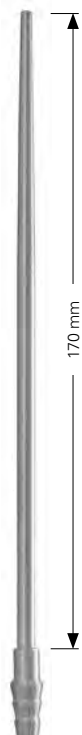
konisch  
conical  
cónico  
conico

**10-942-05** Ø 4,5 mm



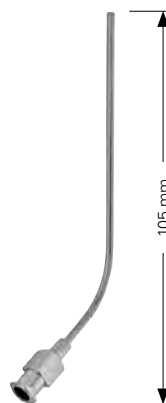
konisch  
conical  
cónico  
conico

**10-942-13** Ø 4,5 mm



konisch  
conical  
cónico  
conico

**10-942-18** Ø 3,0 mm



### ROSEN

<b>10-944-05</b>	Ø 0,5 mm
<b>10-944-06</b>	Ø 0,6 mm
<b>10-944-07</b>	Ø 0,7 mm
<b>10-944-08</b>	Ø 0,8 mm
<b>10-944-09</b>	Ø 0,9 mm
<b>10-944-10</b>	Ø 1,0 mm
<b>10-944-12</b>	Ø 1,2 mm
<b>10-944-14</b>	Ø 1,4 mm
<b>10-944-15</b>	Ø 1,5 mm
<b>10-944-18</b>	Ø 1,8 mm
<b>10-944-20</b>	Ø 2,0 mm
<b>10-944-22</b>	Ø 2,2 mm
<b>10-944-25</b>	Ø 2,5 mm
<b>10-944-30</b>	Ø 3,0 mm



### ROSEN

<b>10-944-55</b>	Ø 0,5 mm
<b>10-944-56</b>	Ø 0,6 mm
<b>10-944-57</b>	Ø 0,7 mm
<b>10-944-58</b>	Ø 0,8 mm
<b>10-944-59</b>	Ø 0,9 mm
<b>10-944-60</b>	Ø 1,0 mm
<b>10-944-62</b>	Ø 1,2 mm
<b>10-944-64</b>	Ø 1,4 mm
<b>10-944-65</b>	Ø 1,5 mm
<b>10-944-68</b>	Ø 1,8 mm
<b>10-944-70</b>	Ø 2,0 mm
<b>10-944-72</b>	Ø 2,2 mm
<b>10-944-75</b>	Ø 2,5 mm
<b>10-944-80</b>	Ø 3,0 mm

Saughandgriff mit Unterbrecher  
Suction handle with finger cut off  
Mango para aspiración y interrupter  
Manico per aspirazione e interruttore



### WULLSTEIN

**10-944-00** 11,0 cm, 4 3/8"

Saughandgriff mit Unterbrecher  
Suction handle with finger cut off  
Mango para aspiración y interrupter  
Manico per aspirazione e interruttore



**10-944-01** 11,0 cm, 4 3/8"

Saughandgriff mit Unterbrecher  
Suction handle with finger cut off  
Mango para aspiración y interrupter  
Manico per aspirazione e interruttore

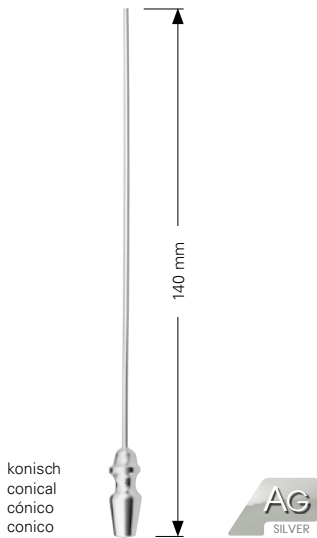


**10-944-02** 6,0 cm, 2 3/8"

Saughandgriff mit Unterbrecher  
Suction handle with finger cut off  
Mango para aspiración y interrupter  
Manico per aspirazione e interruttore

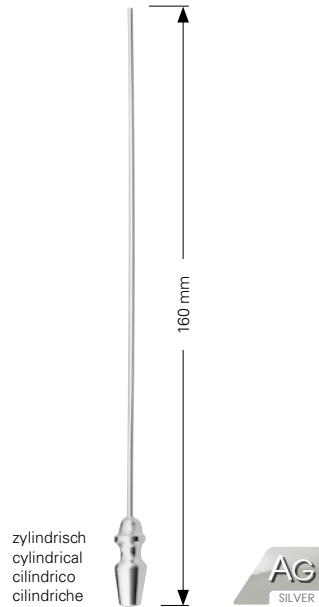


**10-944-03** 10,0 cm, 4"



### WULLSTEIN

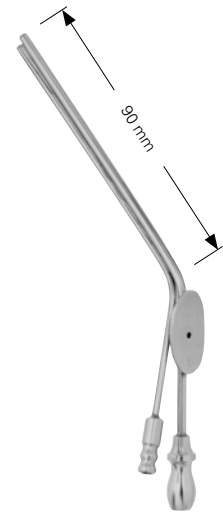
**10-946-01** Ø 1,5 mm



### WULLSTEIN

**10-946-02** Ø 1,5 mm

**10-946-03** Ø 2,0 mm



### HOUSE

**10-947-07** Ø 0,9 x 0,7 mm

**10-947-09** Ø 1,2 x 0,9 mm

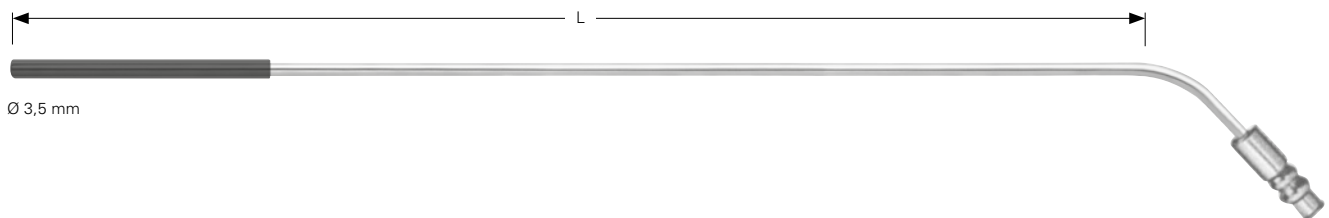
**10-947-12** Ø 1,5 x 1,2 mm

**10-947-18** Ø 1,8 x 1,8 mm

**10-947-19** Ø 2,5 x 2,0 mm

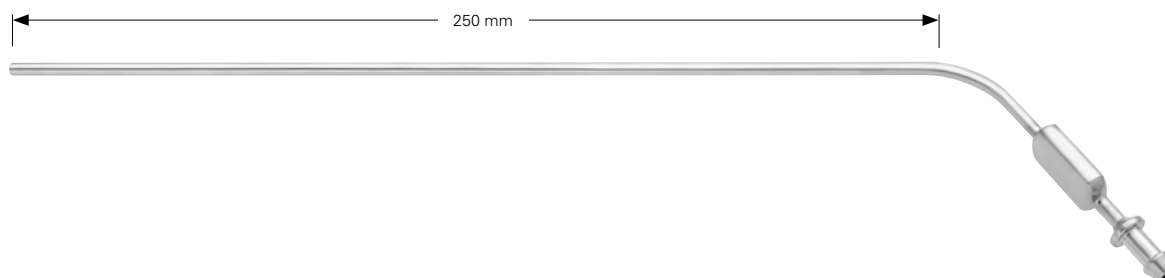
**10-947-20** Ø 3,0 x 2,0 mm

**10-947-21** Ø 4,5 x 2,0 mm



**10-950-35** 35,0 cm, 13 3/4"

**10-950-50** 50,0 cm, 19 1/2"



**10-951-20** Ø 2,0 mm

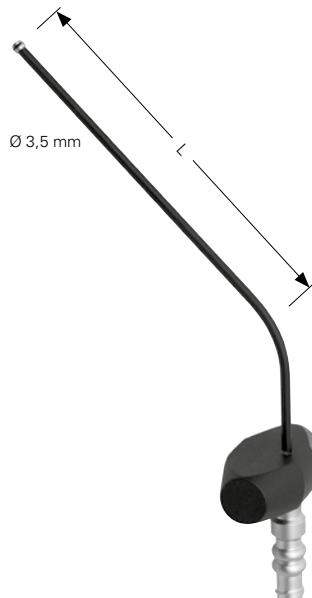
**10-951-25** Ø 2,5 mm

**10-951-30** Ø 3,0 mm

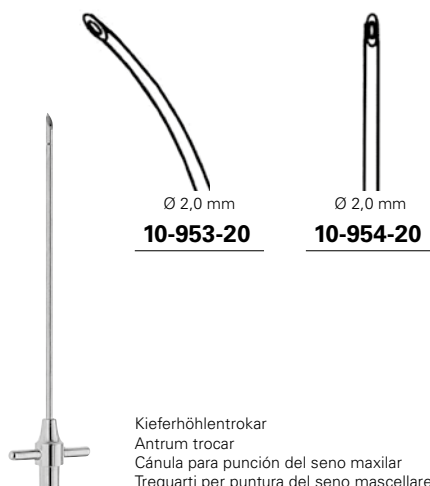




Koagulations Saugrohr, isoliert  
Coagulation suction tube, insulated  
Tubo de aspiración y coagulación, aislado  
Tubo per aspirazione coagulazione, isolato



**10-953-10** 10,0 cm, 4 "  
**10-953-26** 26,0 cm, 10 1/4 "



Kieferhöhlentrocker  
Antrum trocar  
Cánula para punción del seno maxilar  
Trequarti per puntura del seno mascellare

### RUSKIN

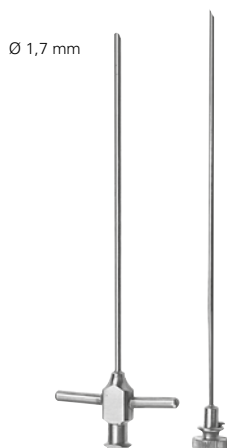
**10-953-20 - 10-954-20** 10,0 cm, 4 "



### HAJEK

**10-954-16** Ø 3,5 mm

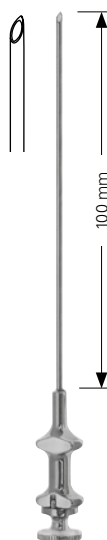
Kieferhöhlentrocker  
Antrum trocar  
Cánula para punción del seno maxilar  
Trequarti per puntura del seno mascellare



### LICHTWITZ

**10-955-00** 11,0 cm, 4 3/8 "

Kieferhöhlenpunktionkanülen  
Antrum trocar needles  
Cánula para punción del seno maxilar  
Trequarti per puntura del seno mascellare



### LICHTWITZ

**10-955-15** Ø 1,5 mm  
**10-955-18** Ø 1,8 mm  
**10-955-20** Ø 2,0 mm

Kieferhöhlenpunktionkanülen  
Antrum trocar needles  
Cánula para punción del seno maxilar  
Trequarti per puntura del seno mascellare



### LICHTWITZ

**10-956-15** Ø 1,5 mm  
**10-956-18** Ø 1,8 mm  
**10-956-20** Ø 2,0 mm  
**10-956-25** Ø 2,5 mm

Kieferhöhlenspülkanülen  
Antrum irrigation cannulas  
Cánula para irrigación del seno maxilar  
Cannule per irrigazione del seno mascellare



Kieferhöhlenspülkanülen  
Antrum irrigation cannulas  
Cánula para irrigación del seno maxilar  
Cannule per irrigazione del seno mascellare

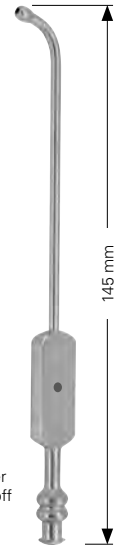


mit Unterbrecher  
with finger cut-off  
con interruptor  
con interruttore

Kieferhöhlenspülkanülen  
Antrum irrigation cannulas  
Cánula para irrigación del seno maxilar  
Cannule per irrigazione del seno mascellare



Kieferhöhlenspülkanülen  
Antrum irrigation cannulas  
Cánula para irrigación del seno maxilar  
Cannule per irrigazione del seno mascellare



mit Unterbrecher  
with finger cut-off  
con interruptor  
con interruttore

**EICKEN**

<b>10-957-25</b>	Ø 2,5 mm
<b>10-957-30</b>	Ø 3,0 mm
<b>10-957-40</b>	Ø 4,0 mm

**EICKEN**

<b>10-957-26</b>	Ø 2,5 mm
<b>10-957-31</b>	Ø 3,0 mm
<b>10-957-41</b>	Ø 4,0 mm

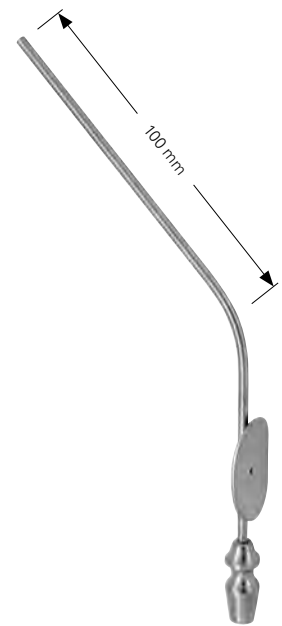
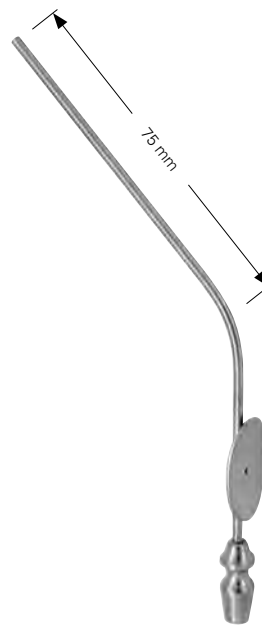
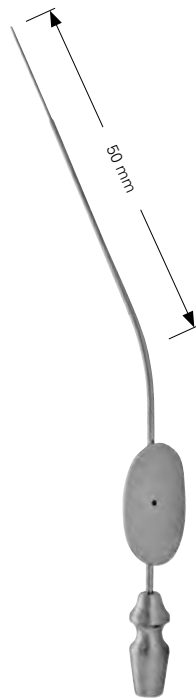
**EICKEN**

<b>10-958-25</b>	Ø 2,5 mm
<b>10-958-30</b>	Ø 3,0 mm
<b>10-958-40</b>	Ø 4,0 mm

**EICKEN**

<b>10-958-26</b>	Ø 2,5 mm
<b>10-958-31</b>	Ø 3,0 mm
<b>10-958-41</b>	Ø 4,0 mm

biegsam  
malleable  
maleables  
malleabili



<b>10-960-05</b>	Ø 0,5 mm
<b>10-960-07</b>	Ø 0,7 mm
<b>10-960-10</b>	Ø 1,0 mm
<b>10-960-13</b>	Ø 1,3 mm
<b>10-960-15</b>	Ø 1,5 mm
<b>10-960-20</b>	Ø 2,0 mm
<b>10-960-25</b>	Ø 2,5 mm
<b>10-960-30</b>	Ø 3,0 mm

**BARNES**

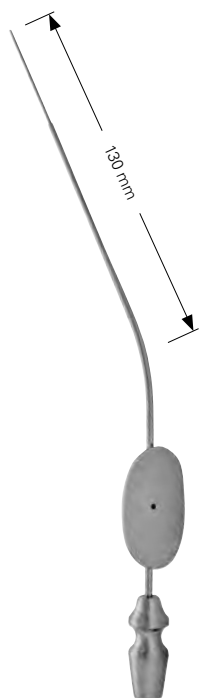
<b>10-961-15</b>	Ø 1,5 mm
<b>10-961-17</b>	Ø 1,7 mm
<b>10-961-20</b>	Ø 2,0 mm

**BARON**

<b>10-962-03</b>	3 Charr.
<b>10-962-05</b>	5 Charr.
<b>10-962-07</b>	7 Charr.

**BARON**

<b>10-963-03</b>	3 Charr.
<b>10-963-05</b>	5 Charr.
<b>10-963-07</b>	7 Charr.



### SCHUHKNECHT

<b>10-963-20</b>	Ø 1,0 mm
<b>10-963-24</b>	Ø 0,5 mm



### ZOELLNER

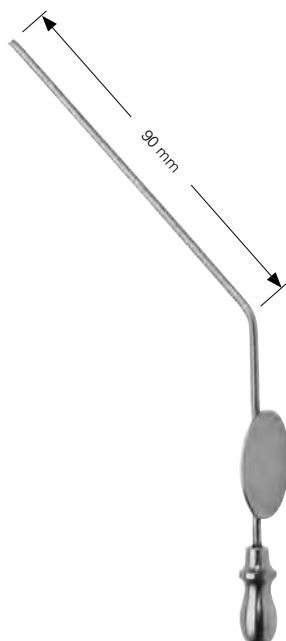
<b>10-964-00</b>	15,0 cm, 6"
------------------	-------------

Saugkanülen Aufsätze für 10-964-00  
 Suction cannula tips for 10-964-00  
 Puntas, cánula para aspiración, para 10-964-00  
 Punta cannulata d'aspirazione, pour 10-964-00



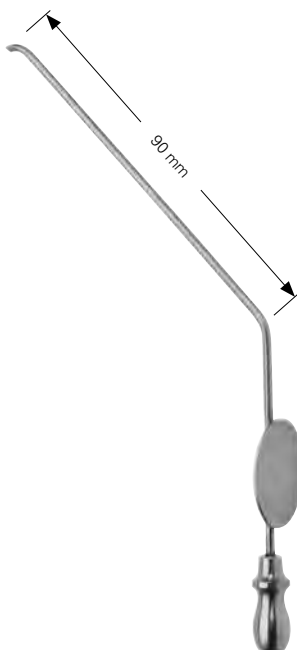
### ZOELLNER

<b>10-964-05</b>	Ø 0,5 mm
<b>10-964-07</b>	Ø 0,7 mm
<b>10-964-09</b>	Ø 0,9 mm
<b>10-964-12</b>	Ø 1,2 mm



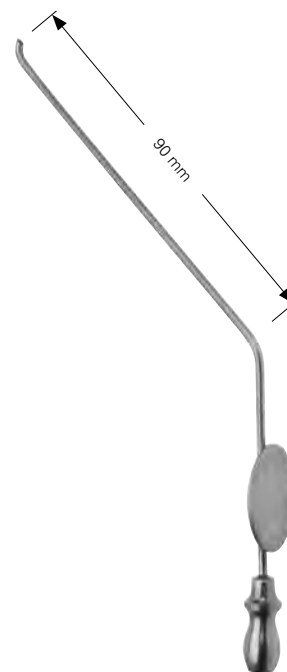
### VERHOEVEN 45°

<b>10-965-12</b>	Ø 1,2 mm
<b>10-965-15</b>	Ø 1,5 mm
<b>10-965-20</b>	Ø 2,0 mm
<b>10-965-30</b>	Ø 3,0 mm



### VERHOEVEN 45°

<b>10-966-12</b>	Ø 1,2 mm
<b>10-966-15</b>	Ø 1,5 mm
<b>10-966-20</b>	Ø 2,0 mm
<b>10-966-30</b>	Ø 3,0 mm



### VERHOEVEN 45°

<b>10-967-12</b>	Ø 1,2 mm
<b>10-967-15</b>	Ø 1,5 mm
<b>10-967-20</b>	Ø 2,0 mm
<b>10-967-30</b>	Ø 3,0 mm



# 11

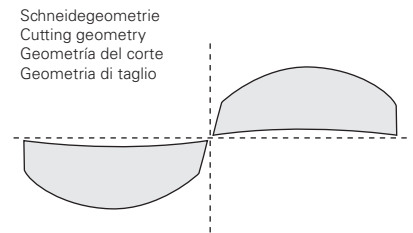
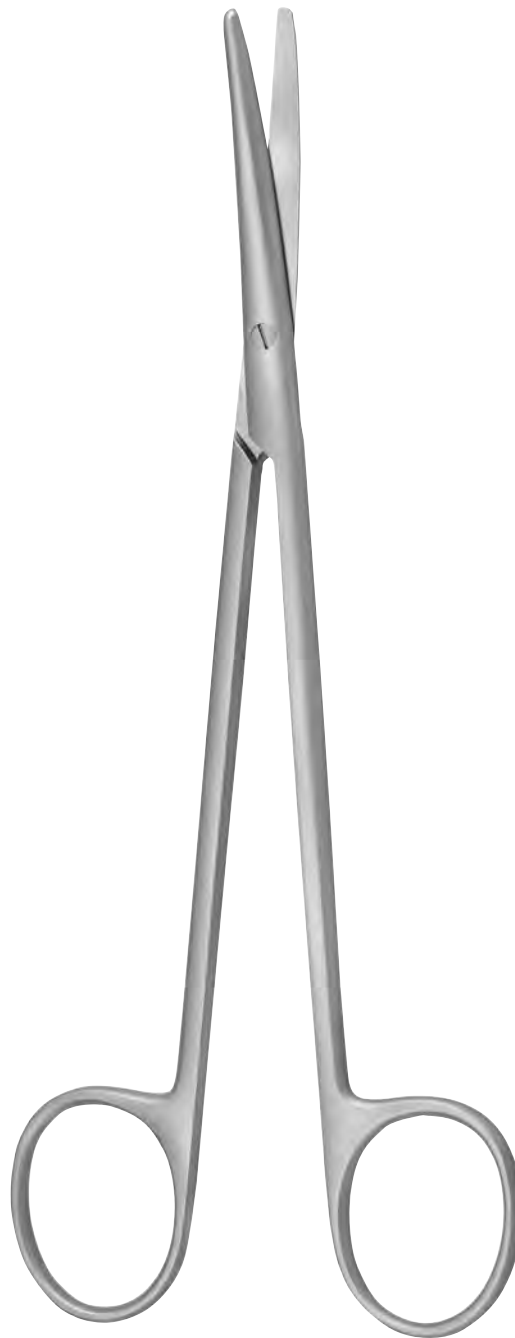
Scheren

Scissors

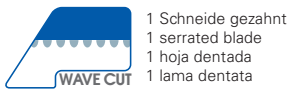
Tijeras

Forbici





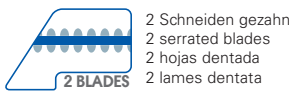
Ausführungen | Specification  
Especificación | Specifica



1 Schneide gezahnt  
1 serrated blade  
1 hoja dentada  
1 lama dentata

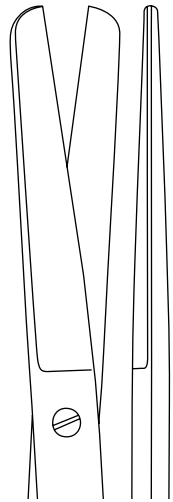


1 Schneide gezahnt  
1 serrated blade  
1 hoja dentada  
1 lama dentata



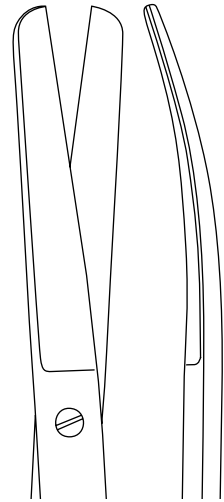
2 Schneiden gezahnt  
2 serrated blades  
2 hojas dentada  
2 lames dentata

- Jede AMNOTEC Schere wird aus hochwertigem Scherenstahl gefertigt. Für eine dauerhaft exzellente Schnittleistung garantieren speziell vergütete Schneiden, konstante Härte und eine qualitätsgerechte Schnittprüfung vor Auslieferung.
- Every pair of AMNOTEC scissors is manufactured from high-quality cutter-grade steel. Specially tempered blades, consistent hardness and cutting tests to ensure quality before shipping guaranteed outstanding and continuing cutting performance.
- Todas las tijeras AMNOTEC se fabrican en acero de alta calidad para tijeras. El tratamiento especial que reciben las hojas, así como la dureza constante y la revisión de calidad que se realiza antes de la entrega, garantizan un rendimiento de corte excelente y duradero.
- Tutte le forbici AMNOTEC sono realizzate in acciaio di qualità superiore. Le lame dalla durezza costante, realizzate mediante speciale lavorazione e sottoposte a controlli di qualità prima della distribuzione, garantiscono prestazioni di taglio costanti ed eccellenti.



**STANDARD Fig. 1**

<b>11-000-10</b>	10,0 cm, 4"
<b>11-000-11</b>	11,0 cm, 4 <sup>3</sup> / <sub>8</sub> "
<b>11-000-13</b>	13,0 cm, 5 <sup>1</sup> / <sub>8</sub> "
<b>11-000-14</b>	14,0 cm, 5 <sup>1</sup> / <sub>2</sub> "
<b>11-000-15</b>	15,0 cm, 6"
<b>11-000-16</b>	16,0 cm, 6 <sup>1</sup> / <sub>4</sub> "
<b>11-000-17</b>	17,0 cm, 6 <sup>3</sup> / <sub>4</sub> "
<b>11-000-18</b>	18,0 cm, 7"
<b>11-000-20</b>	20,0 cm, 8"

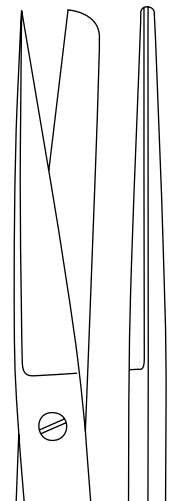


**STANDARD Fig. 1**

<b>11-001-10</b>	10,0 cm, 4"
<b>11-001-11</b>	11,0 cm, 4 <sup>3</sup> / <sub>8</sub> "
<b>11-001-13</b>	13,0 cm, 5 <sup>1</sup> / <sub>8</sub> "
<b>11-001-14</b>	14,0 cm, 5 <sup>1</sup> / <sub>2</sub> "
<b>11-001-15</b>	15,0 cm, 6"
<b>11-001-16</b>	16,0 cm, 6 <sup>1</sup> / <sub>4</sub> "
<b>11-001-17</b>	17,0 cm, 6 <sup>3</sup> / <sub>4</sub> "
<b>11-001-18</b>	18,0 cm, 7"
<b>11-001-20</b>	20,0 cm, 8"

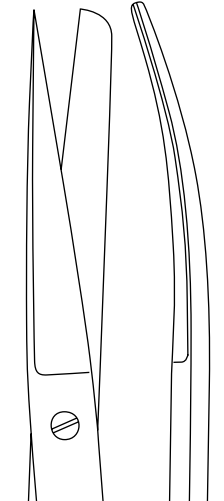
**STANDARD Fig. 2**

**11-002-14 W** 14,0 cm, 5 <sup>1</sup>/<sub>2</sub>"



**STANDARD Fig. 2**

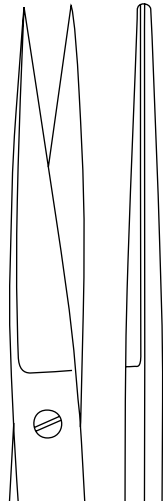
<b>11-002-10</b>	10,0 cm, 4"
<b>11-002-11</b>	11,0 cm, 4 <sup>3</sup> / <sub>8</sub> "
<b>11-002-13</b>	13,0 cm, 5 <sup>1</sup> / <sub>8</sub> "
<b>11-002-14</b>	14,0 cm, 5 <sup>1</sup> / <sub>2</sub> "
<b>11-002-15</b>	15,0 cm, 6"
<b>11-002-16</b>	16,0 cm, 6 <sup>1</sup> / <sub>4</sub> "
<b>11-002-17</b>	17,0 cm, 6 <sup>3</sup> / <sub>4</sub> "
<b>11-002-18</b>	18,0 cm, 7"
<b>11-002-20</b>	20,0 cm, 8"



**STANDARD Fig. 2**

<b>11-003-10</b>	10,0 cm, 4"
<b>11-003-11</b>	11,0 cm, 4 <sup>3</sup> / <sub>8</sub> "
<b>11-003-13</b>	13,0 cm, 5 <sup>1</sup> / <sub>8</sub> "
<b>11-003-14</b>	14,0 cm, 5 <sup>1</sup> / <sub>2</sub> "
<b>11-003-15</b>	15,0 cm, 6"
<b>11-003-16</b>	16,0 cm, 6 <sup>1</sup> / <sub>4</sub> "
<b>11-003-17</b>	17,0 cm, 6 <sup>3</sup> / <sub>4</sub> "
<b>11-003-18</b>	18,0 cm, 7"
<b>11-003-20</b>	20,0 cm, 8"





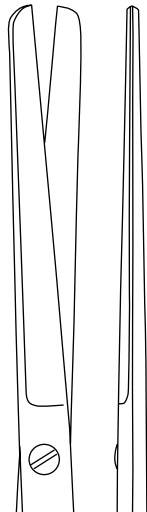
**STANDARD Fig. 3**

<b>11-004-10</b>	10,0 cm, 4 "
<b>11-004-11</b>	11,0 cm, 4 3/8 "
<b>11-004-13</b>	13,0 cm, 5 1/8 "
<b>11-004-14</b>	14,0 cm, 5 1/2 "
<b>11-004-15</b>	15,0 cm, 6 "
<b>11-004-16</b>	16,0 cm, 6 1/4 "
<b>11-004-17</b>	17,0 cm, 6 3/4 "
<b>11-004-18</b>	18,0 cm, 7 "
<b>11-004-20</b>	20,0 cm, 8 "



**STANDARD Fig. 3**

<b>11-005-10</b>	10,0 cm, 4 "
<b>11-005-11</b>	11,0 cm, 4 3/8 "
<b>11-005-13</b>	13,0 cm, 5 1/8 "
<b>11-005-14</b>	14,0 cm, 5 1/2 "
<b>11-005-15</b>	15,0 cm, 6 "
<b>11-005-16</b>	16,0 cm, 6 1/4 "
<b>11-005-17</b>	17,0 cm, 6 3/4 "
<b>11-005-18</b>	18,0 cm, 7 "
<b>11-005-20</b>	20,0 cm, 8 "



**11-010-13**  
**11-010-14**

schlanke Modelle  
delicate pattern  
modelos finos  
modelli fini

**GRAZIL Fig. 1**

<b>11-010-13</b>	13,0 cm, 5 1/8 "
<b>11-010-14</b>	14,0 cm, 5 1/2 "



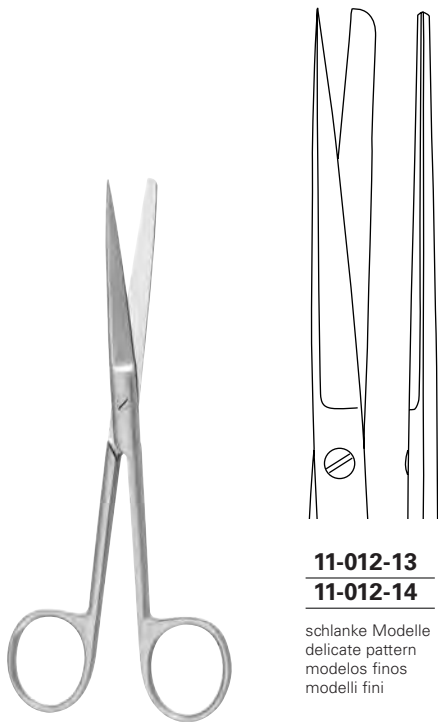
**11-011-13**  
**11-011-14**

schlanke Modelle  
delicate pattern  
modelos finos  
modelli fini

**GRAZIL Fig. 1**

<b>11-011-13</b>	13,0 cm, 5 1/8 "
<b>11-011-14</b>	14,0 cm, 5 1/2 "



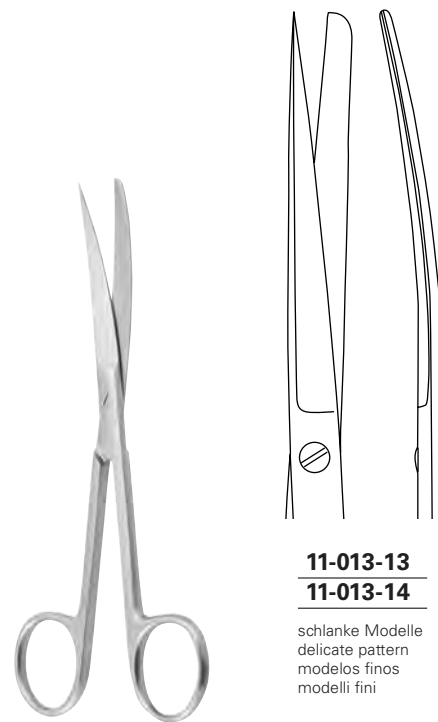


**11-012-13**  
**11-012-14**

schlanke Modelle  
delicate pattern  
modelos finos  
modelli fini

**GRAZIL Fig. 2**

**11-012-13** 13,0 cm, 5 1/8"  
**11-012-14** 14,0 cm, 5 1/2"

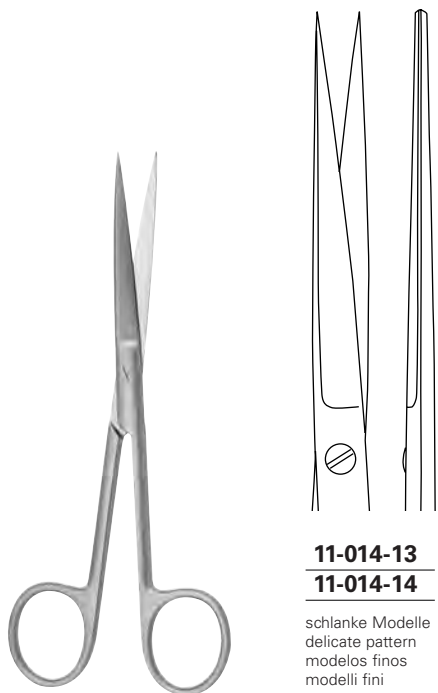


**11-013-13**  
**11-013-14**

schlanke Modelle  
delicate pattern  
modelos finos  
modelli fini

**GRAZIL Fig. 2**

**11-013-13** 13,0 cm, 5 1/8"  
**11-013-14** 14,0 cm, 5 1/2"

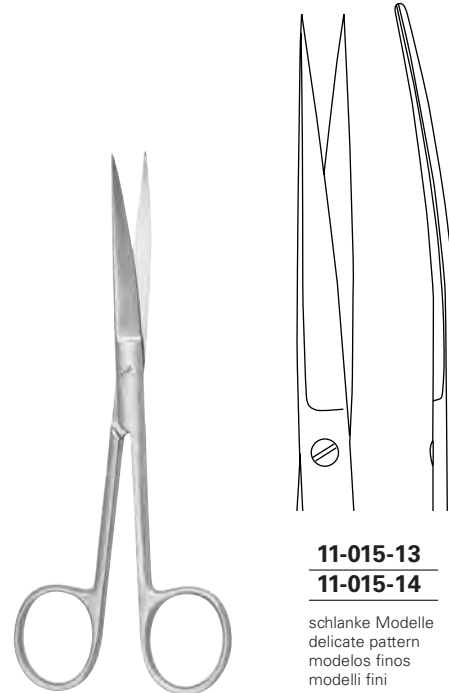


**11-014-13**  
**11-014-14**

schlanke Modelle  
delicate pattern  
modelos finos  
modelli fini

**GRAZIL Fig. 3**

**11-014-13** 13,0 cm, 5 1/8"  
**11-014-14** 14,0 cm, 5 1/2"

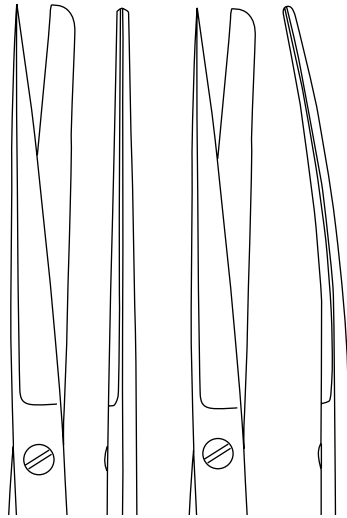


**11-015-13**  
**11-015-14**

schlanke Modelle  
delicate pattern  
modelos finos  
modelli fini

**GRAZIL Fig. 3**

**11-015-13** 13,0 cm, 5 1/8"  
**11-015-14** 14,0 cm, 5 1/2"



**11-020-13**

**11-021-13**



schlanke Modelle  
delicate pattern  
modelos finos  
modelli fini



**11-100-13**

**11-100-14**

**11-100-15**

Inzisionsschere  
Incision Scissors  
Tijera para incision  
Forbici per incision

**GRAZIL**

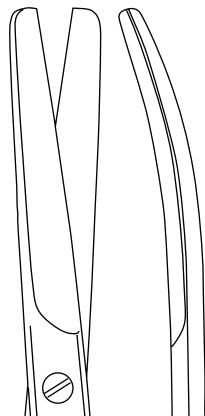
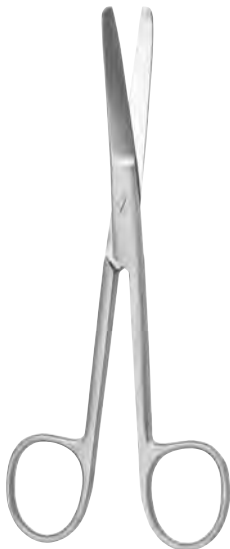
**Fig. 2**

**11-020-13 - 11-021-13** 13,0 cm, 5 1/8"

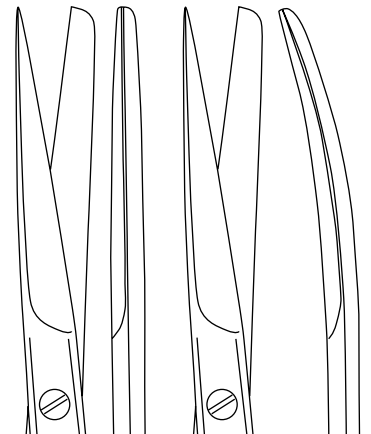
**11-100-13** 13,0 cm, 5 1/8"

**11-100-14** 14,0 cm, 5 1/2"

**11-100-15** 15,0 cm, 6"



**11-103-14**



**11-104-14**

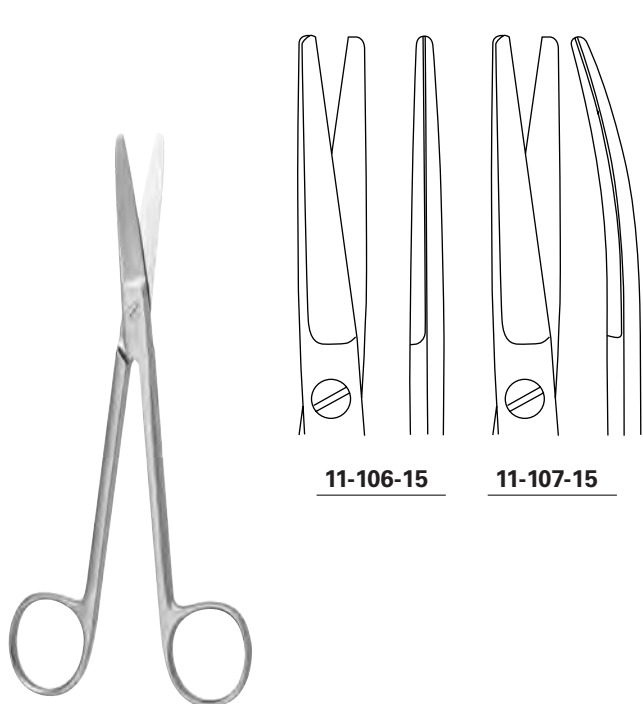
**11-105-14**

**DEAVER**

**11-103-14** 14,0 cm, 5 1/2"

**DEAVER**

**11-104-14 - 11-105-14** 14,0 cm, 5 1/2"

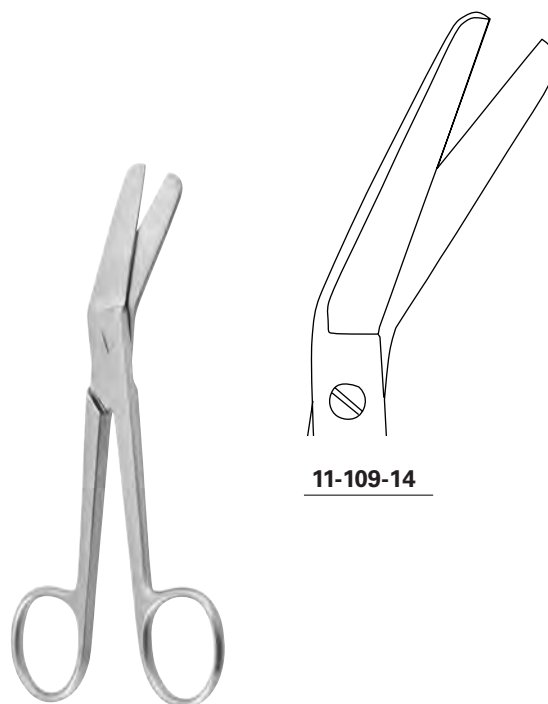


**11-106-15**

**11-107-15**

**MIXTER**

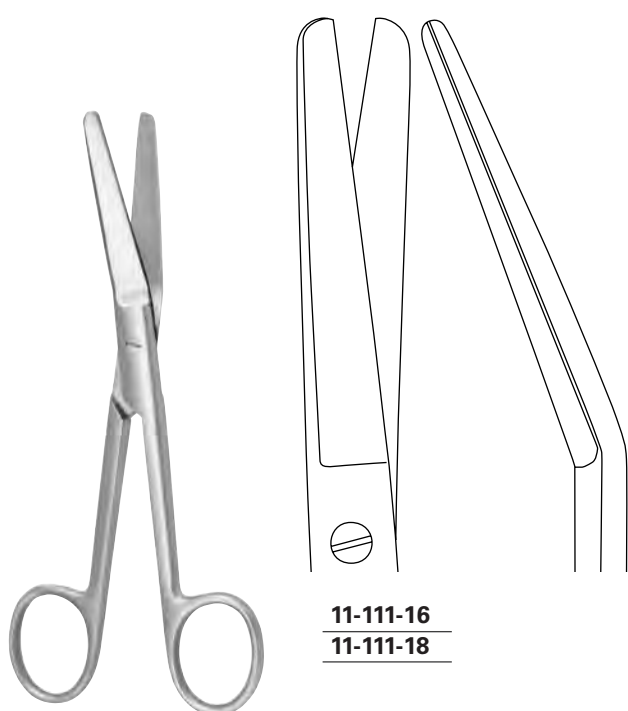
**11-106-15 - 11-107-15** 15,0 cm, 6"



**11-109-14**

**RICHTER**

**11-109-14** 14,0 cm, 5 1/2"



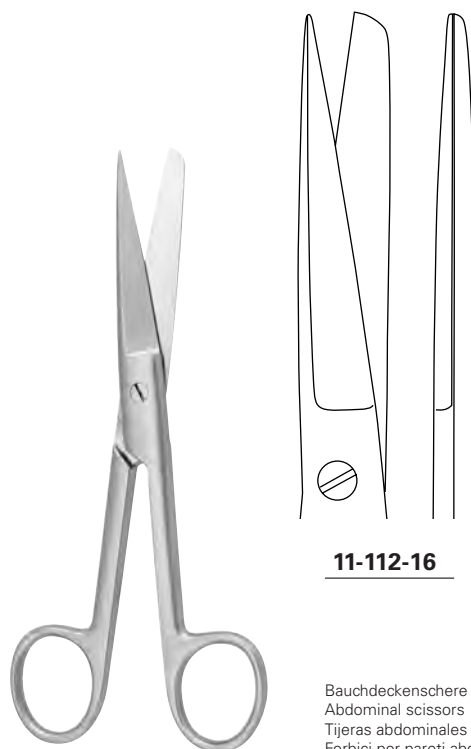
**11-111-16**

**11-111-18**

**FERGUSON**

**11-111-16** 16,0 cm, 6 1/4"

**11-111-18** 18,0 cm, 7"

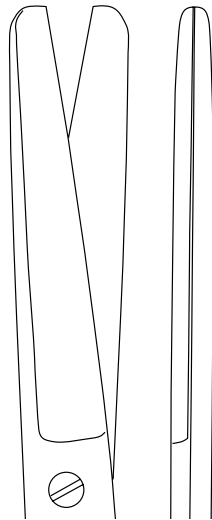


**11-112-16**

**DOYEN**

**11-112-16** 16,0 cm, 6 1/4"

Bauchdeckenschere  
 Abdominal scissors  
 Tijeras abdominales  
 Forbici per pareti abdominali



**11-114-16**  
**11-114-18**



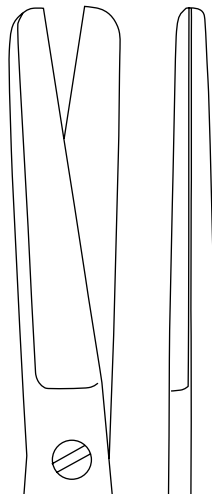
**11-115-16**  
**11-115-18**

Bauchdeckenscheren  
 Abdominal scissors  
 Tijeras abdominales  
 Forbici per pareti abdominali

**DOYEN**

**11-114-16 - 11-115-16** 16,0 cm, 6 ¼"

**11-114-18 - 11-115-86** 18,0 cm, 7"



**11-120-20**  
**11-120-23**  
**11-120-25**

Uterusscheren  
 Uterine scissors  
 Tijeras uterinas  
 Forbici da uteroa



**11-121-20**  
**11-121-23**  
**11-121-25**

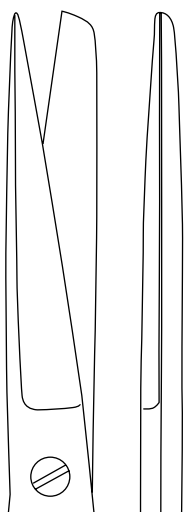
Uterusscheren  
 Uterine scissors  
 Tijeras uterinas  
 Forbici da uteroa

**SIMS**

**11-120-20 - 11-121-20** 20,0 cm, 8"

**11-120-23 - 11-121-23** 23,0 cm, 9"

**11-120-25 - 11-121-25** 25,0 cm, 9 ¾"



**11-122-20**  
**11-122-23**  
**11-122-25**

Uterusscheren  
 Uterine scissors  
 Tijeras uterinas  
 Forbici da uteroa



**11-123-20**  
**11-123-23**  
**11-123-25**

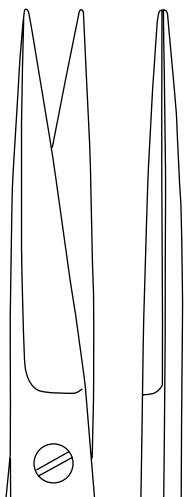
Uterusscheren  
 Uterine scissors  
 Tijeras uterinas  
 Forbici da uteroa

## SIMS

**11-122-20 - 11-123-20** 20,0 cm, 8 "

**11-122-23 - 11-123-23** 23,0 cm, 9 "

**11-122-25 - 11-123-25** 25,0 cm, 9 3/4 "



**11-124-20**  
**11-124-23**  
**11-124-25**

Uterusscheren  
 Uterine scissors  
 Tijeras uterinas  
 Forbici da uteroa



**11-125-20**  
**11-125-23**  
**11-125-25**

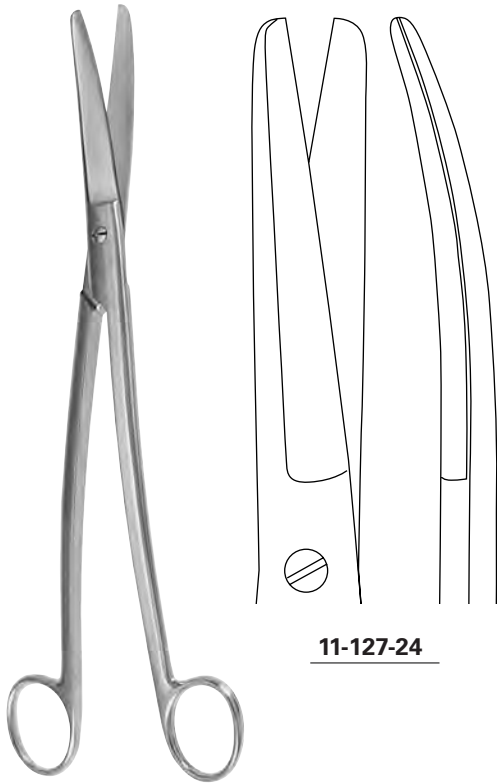
Uterusscheren  
 Uterine scissors  
 Tijeras uterinas  
 Forbici da uteroa

## SIMS

**11-124-20 - 11-125-20** 20,0 cm, 8 "

**11-124-23 - 11-125-23** 23,0 cm, 9 "

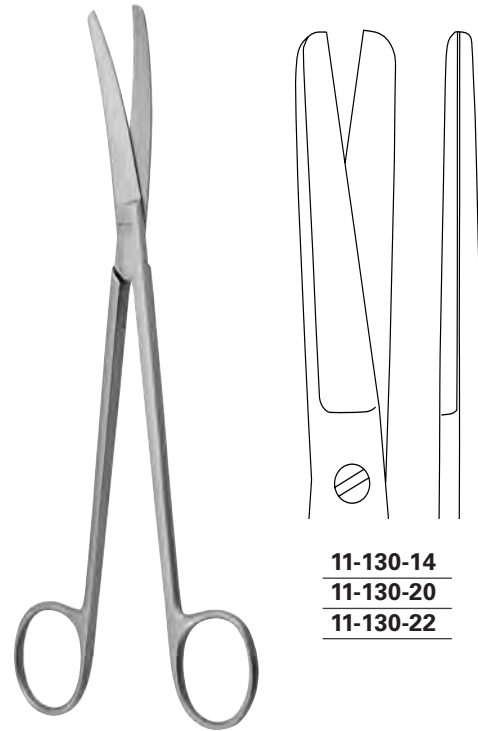
**11-124-25 - 11-125-25** 25,0 cm, 9 3/4 "



**11-127-24**

**SIMS-SIEBOLD-S**

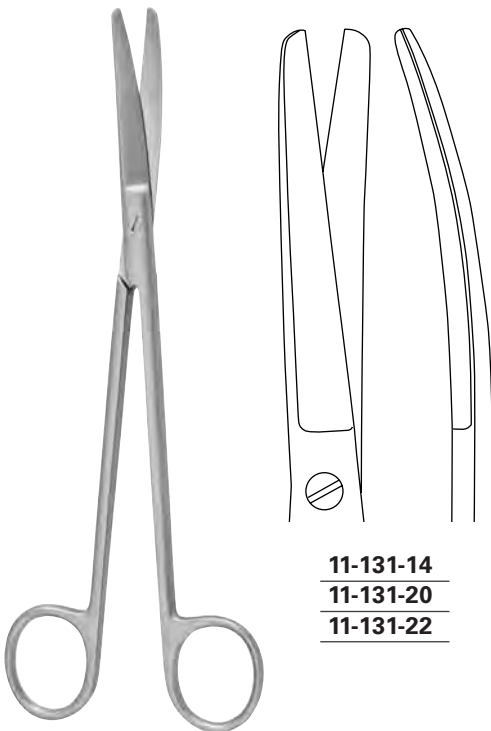
**11-127-24** 24,0 cm, 9 1/2"



**11-130-14**  
**11-130-20**  
**11-130-22**

**WERTHEIM**

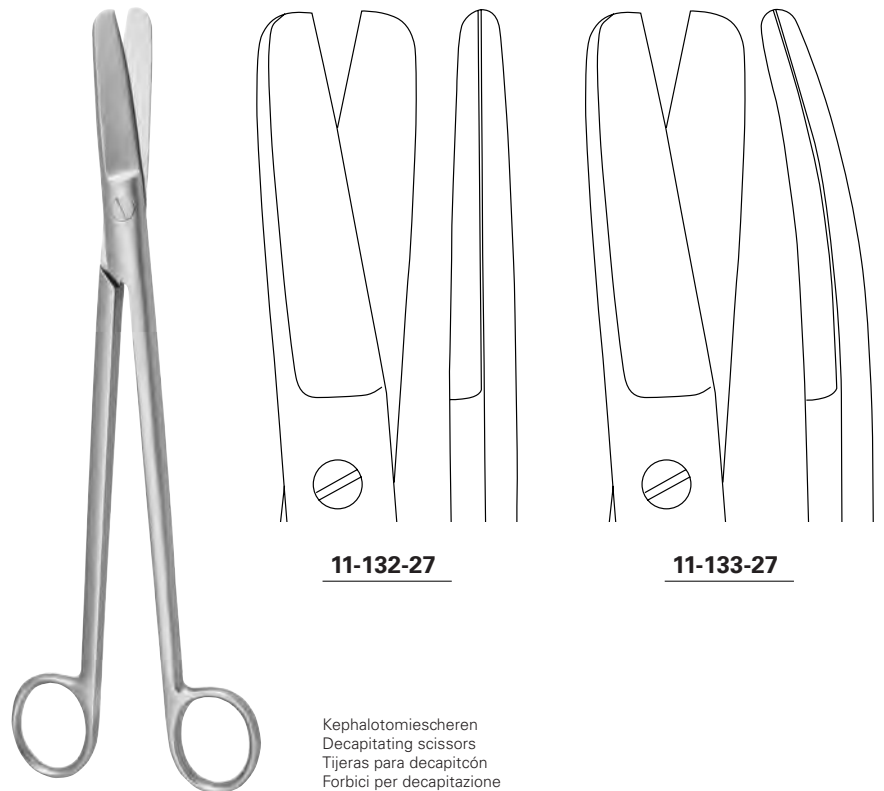
**11-130-14** 14,0 cm, 5 1/2"  
**11-130-20** 20,0 cm, 8"  
**11-130-22** 22,0 cm, 8 3/4"



**11-131-14**  
**11-131-20**  
**11-131-22**

**WERTHEIM**

**11-131-14** 14,0 cm, 5 1/2"  
**11-131-20** 20,0 cm, 8"  
**11-131-22** 22,0 cm, 8 3/4"



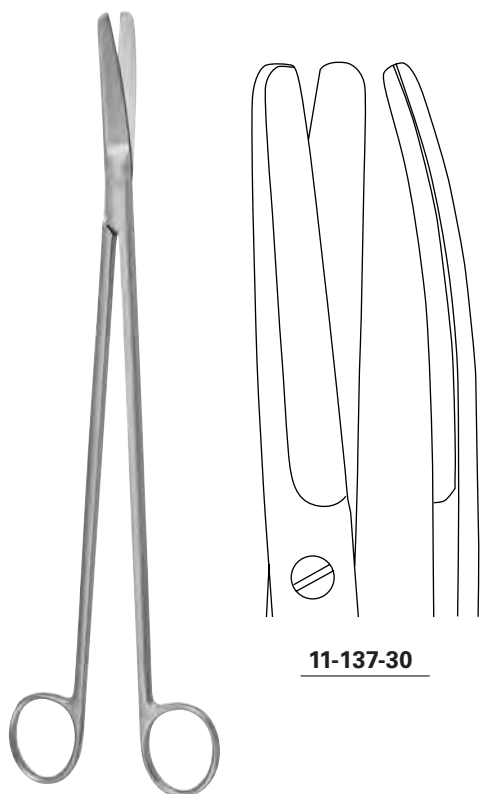
**11-132-27**

**11-133-27**

**DUBOIS**

**11-132-27 - 11-133-27** 27,0 cm, 10 3/4"

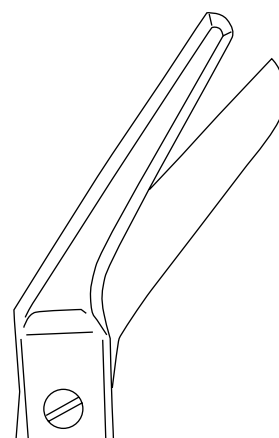
Kephalotomiescheren  
Decapitating scissors  
Tijeras para decapitaci3n  
Forbici per decapitazione



**11-137-30**

**CRAFOORD**

**11-137-30** 30,0 cm, 11 3/4"

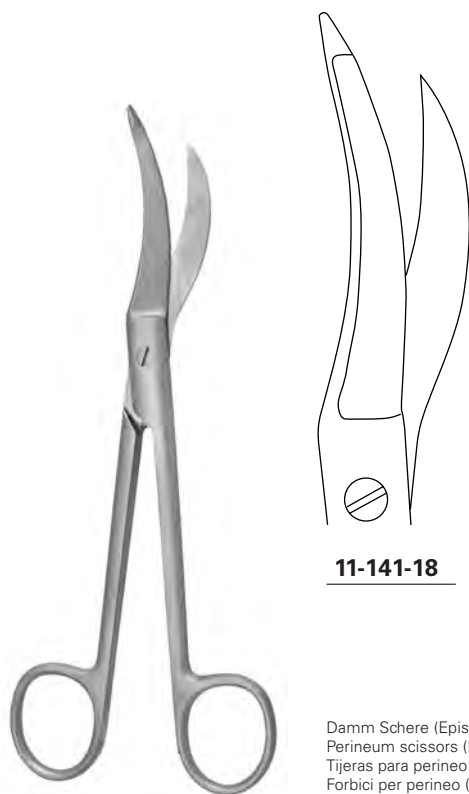


**11-139-14**  
**11-139-22**

**BRAUN-STADLER**

**11-139-14** 14,0 cm, 5 1/2"  
**11-139-22** 22,0 cm, 8 3/4"

Damm Scheren (Episiotomie)  
 Perineum scissors (Episiotomy)  
 Tijeras para perineo (episiotomía)  
 Forbici per perineo (episiotomia)

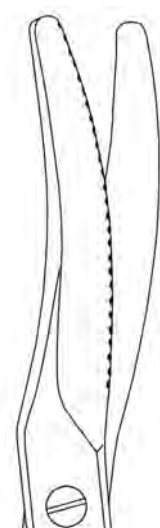


**11-141-18**

**WALDMANN**

**11-141-18** 18,0 cm, 7"

Damm Schere (Episiotomie)  
 Perineum scissors (Episiotomy)  
 Tijeras para perineo (episiotomía)  
 Forbici per perineo (episiotomia)



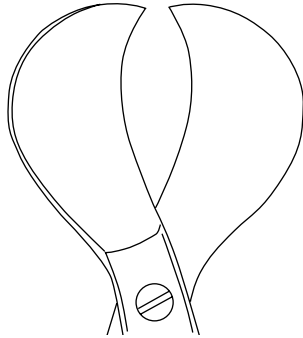
**11-141-20**



Damm Schere (Episiotomie)  
 Perineum scissors (Episiotomy)  
 Tijeras para perineo (episiotomía)  
 Forbici per perineo (episiotomia)

**WALDMANN**

**11-141-20** 20,0 cm, 8"

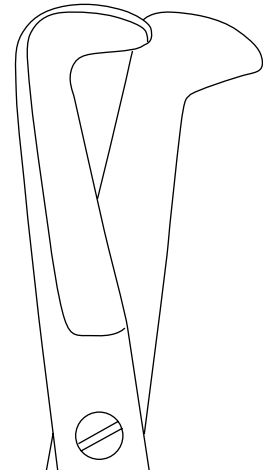


**11-144-10**

Nabelschnurschere  
Umbilical cord scissors  
Tijera umbilicales  
Forbici ombelicali

**MOD. USA**

**11-144-10** 10,0 cm, 4"

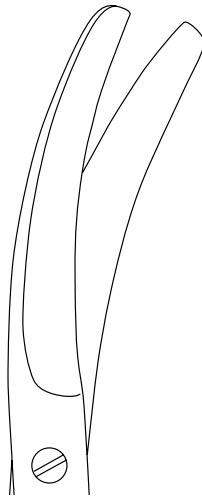


**11-145-16**

Nabelschnurschere  
Umbilical cord scissors  
Tijera umbilicales  
Forbici ombelicali

**SCHUMACHER**

**11-145-16** 16,0 cm, 6 ¼"

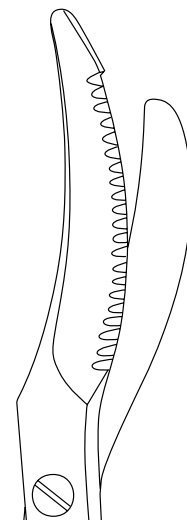
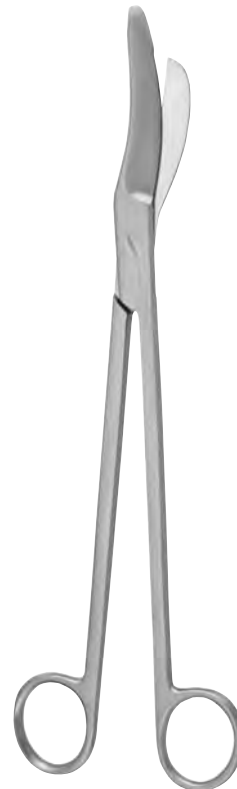


**11-147-13**  
**11-147-16**

Nabelschnurscheren  
Umbilical cord scissors  
Tijera umbilicales  
Forbici ombelicali

**BUSCH**

**11-147-13** 13,0 cm, 5 ⅛"  
**11-147-16** 16,0 cm, 6 ¼"



**11-149-24**



Damm Schere (Episiotomie)  
Perineum scissors (Episiotomy)  
Tijeras para perineo (episiotomía)  
Forbici per perineo (episiotomia)

**11-149-24** 24,0 cm, 9 ½"





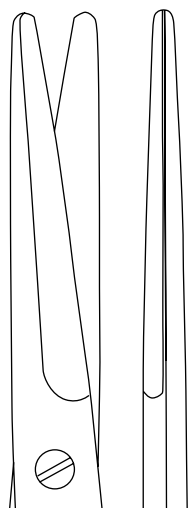
**11-150-21** 21,0 cm, 8 ¼"



**11-152-21** 21,0 cm, 8 ¼"



**11-154-21** 21,0 cm, 8 ¼"



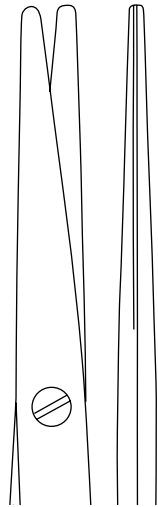
**MAYO**

<b>11-160-14</b>	14,0 cm, 5 ½"
<b>11-160-15</b>	15,0 cm, 6"
<b>11-160-17</b>	17,0 cm, 6 ¾"
<b>11-160-19</b>	19,0 cm, 7 ½"
<b>11-160-23</b>	23,0 cm, 9"
<b>11-160-30</b>	30,0 cm, 11 ¾"



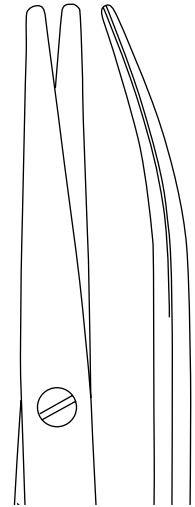
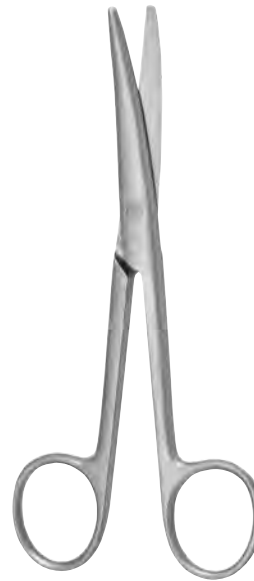
**MAYO**

<b>11-161-14</b>	14,0 cm, 5 ½"
<b>11-161-15</b>	15,0 cm, 6"
<b>11-161-17</b>	17,0 cm, 6 ¾"
<b>11-161-19</b>	19,0 cm, 7 ½"
<b>11-161-23</b>	23,0 cm, 9"
<b>11-161-30</b>	30,0 cm, 11 ¾"



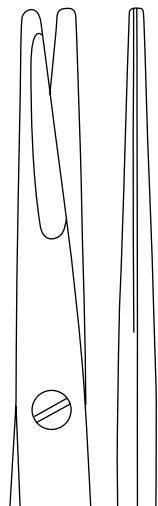
**MAYO-STILLE**

<b>11-170-15</b>	15,0 cm, 6 "
<b>11-170-17</b>	17,0 cm, 6 3/4 "
<b>11-170-19</b>	19,0 cm, 7 1/2 "
<b>11-170-21</b>	21,0 cm, 8 1/4 "
<b>11-170-23</b>	23,0 cm, 9 "



**MAYO-STILLE**

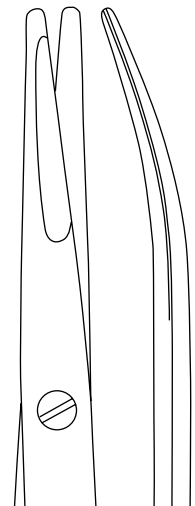
<b>11-171-15</b>	15,0 cm, 6 "
<b>11-171-17</b>	17,0 cm, 6 3/4 "
<b>11-171-19</b>	19,0 cm, 7 1/2 "
<b>11-171-21</b>	21,0 cm, 8 1/4 "
<b>11-171-23</b>	23,0 cm, 9 "



abgeschrägte Blätter  
chamfered blades  
Hojas achaflanadas  
Valve oblique

**MAYO-STILLE**

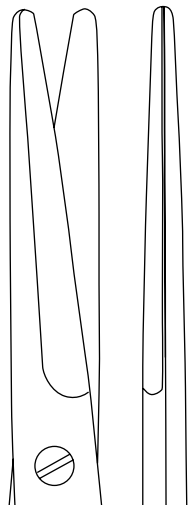
<b>11-172-14</b>	14,0 cm, 5 1/2 "
<b>11-172-17</b>	17,0 cm, 6 3/4 "
<b>11-172-19</b>	19,0 cm, 7 1/2 "
<b>11-172-21</b>	21,0 cm, 8 1/4 "



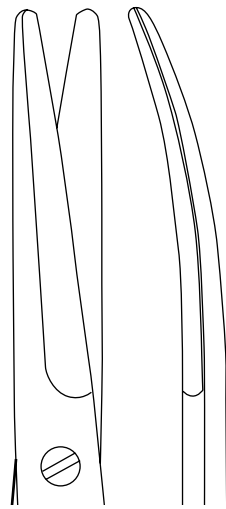
abgeschrägte Blätter  
chamfered blades  
Hojas achaflanadas  
Valve oblique

**MAYO-STILLE**

<b>11-173-14</b>	14,0 cm, 5 1/2 "
<b>11-173-17</b>	17,0 cm, 6 3/4 "
<b>11-173-19</b>	19,0 cm, 7 1/2 "
<b>11-173-21</b>	21,0 cm, 8 1/4 "



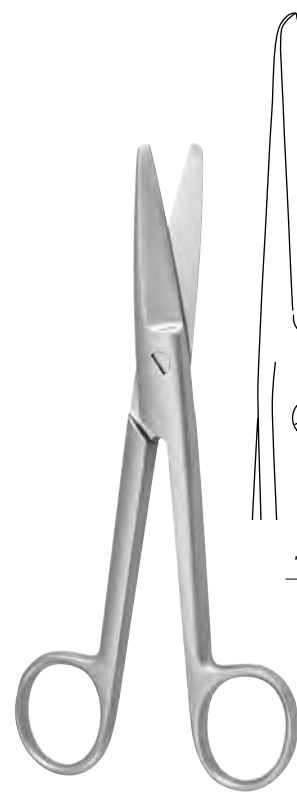
**11-166-22**



**11-167-22**

**MAYO-HARRINGTON**

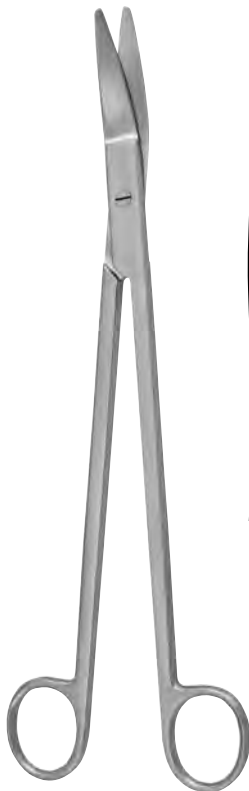
**11-166-22 - 11-167-22** 22,0 cm, 8 3/4"



**11-176-17**

**MAYO-NOBLE**

**11-176-17** 17,0 cm, 6 3/4"



**11-175-24**

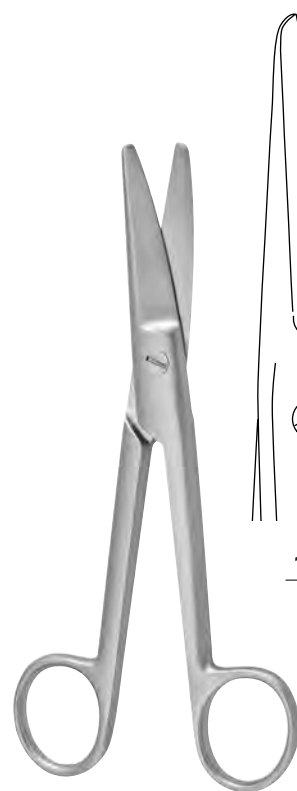


**11-175-25**

Kapselscheren  
Capsula scissors  
Tijeras de cápsula  
Forbice per capsula

**RESANO**

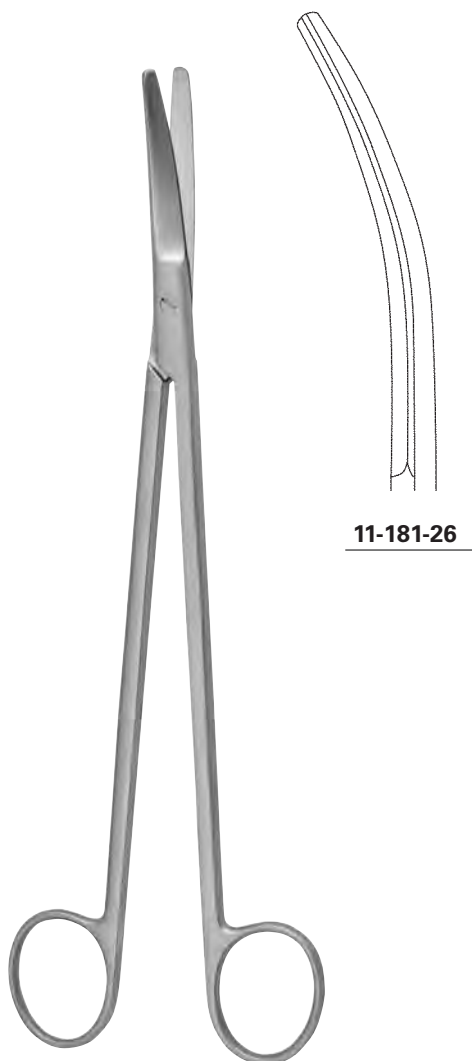
**11-175-24 - 11-175-25** 24,5 cm, 9 2/3"



**11-177-17**

**MAYO-NOBLE**

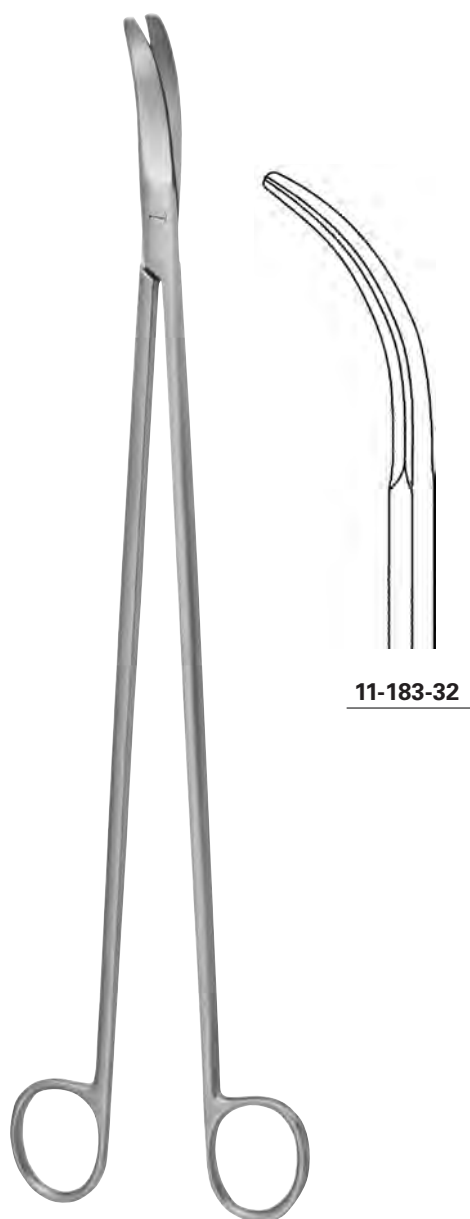
**11-177-17** 17,0 cm, 6 3/4"



**11-181-26**

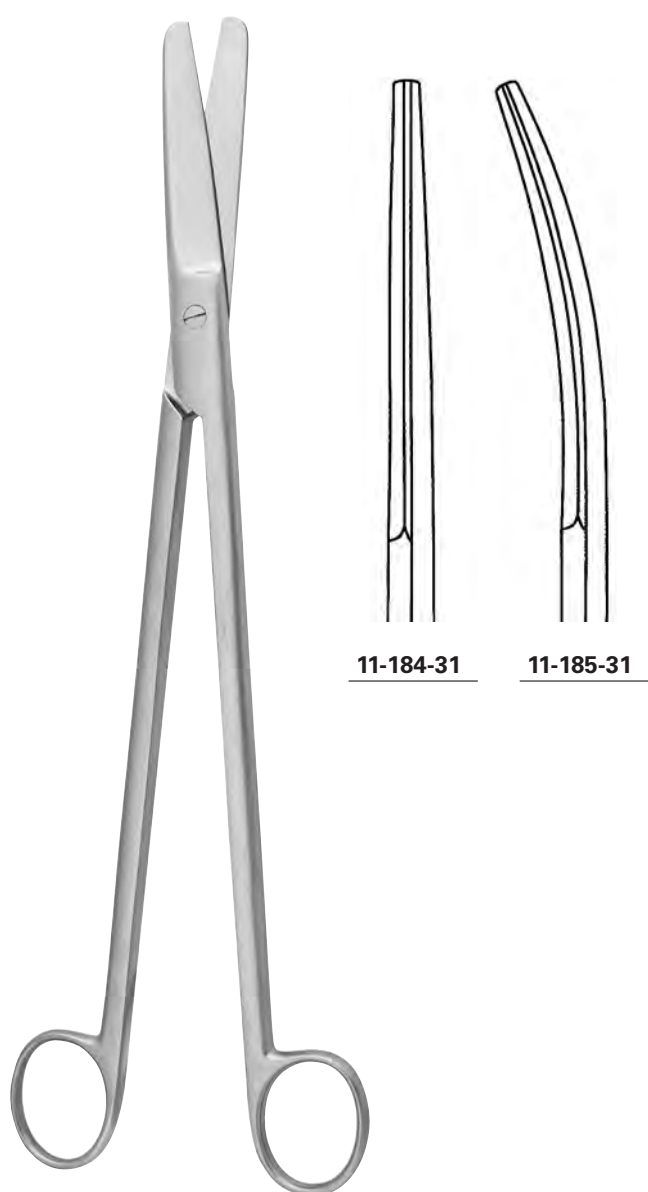
**LLOYD-DAVIES**

**11-181-26** 26,0 cm, 10 ¼"



**11-183-32**

**11-183-32** 32,0 cm, 12 ½"

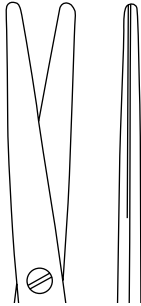
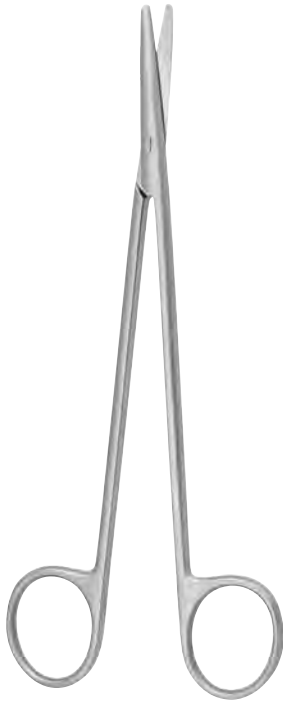


11-184-31

11-185-31

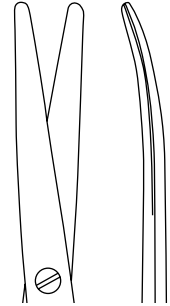
### STELZNER

11-184-31 - 11-185-31 31,0 cm, 12 1/4"



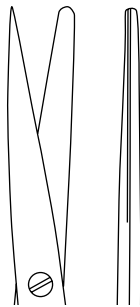
**METZENBAUM**

<b>11-200-14</b>	14,0 cm, 5 1/2 "
<b>11-200-18</b>	18,0 cm, 7 "
<b>11-200-20</b>	20,0 cm, 8 "
<b>11-200-23</b>	23,0 cm, 9 "
<b>11-200-25</b>	25,0 cm, 9 3/4 "
<b>11-200-28</b>	28,0 cm, 11 "
<b>11-200-30</b>	30,0 cm, 12 "
<b>11-200-36</b>	36,0 cm, 14 1/4 "



**METZENBAUM**

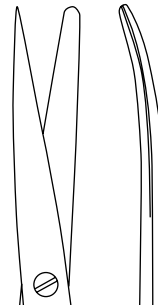
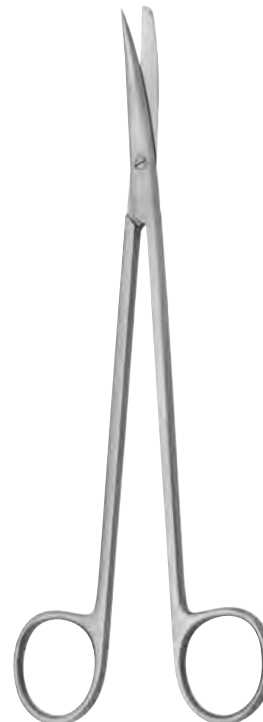
<b>11-201-14</b>	14,0 cm, 5 1/2 "
<b>11-201-18</b>	18,0 cm, 7 "
<b>11-201-20</b>	20,0 cm, 8 "
<b>11-201-23</b>	23,0 cm, 9 "
<b>11-201-25</b>	25,0 cm, 9 3/4 "
<b>11-201-28</b>	28,0 cm, 11 "
<b>11-201-30</b>	30,0 cm, 12 "
<b>11-201-36</b>	36,0 cm, 14 1/4 "



<b>11-202-14</b>
<b>11-202-18</b>
<b>11-202-20</b>

**METZENBAUM**

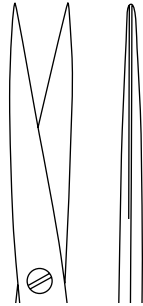
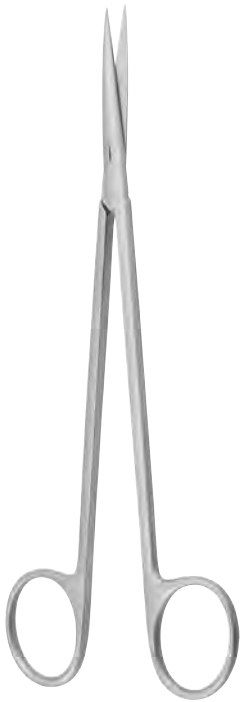
<b>11-202-14</b>	14,0 cm, 5 1/2 "
<b>11-202-18</b>	18,0 cm, 7 "
<b>11-202-20</b>	20,0 cm, 8 "



<b>11-203-14</b>
<b>11-203-18</b>
<b>11-203-20</b>

**METZENBAUM**

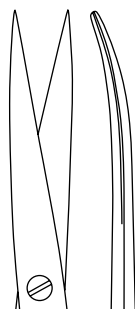
<b>11-203-14</b>	14,0 cm, 5 1/2 "
<b>11-203-18</b>	18,0 cm, 7 "
<b>11-203-20</b>	20,0 cm, 8 "



**11-204-14**  
**11-204-18**  
**11-204-20**  
**11-204-23**

**METZENBAUM**

<b>11-204-14</b>	14,0 cm, 5 ½ "
<b>11-204-18</b>	18,0 cm, 7 "
<b>11-204-20</b>	20,0 cm, 8 "
<b>11-204-23</b>	23,0 cm, 9 "



**11-205-14**

**METZENBAUM**

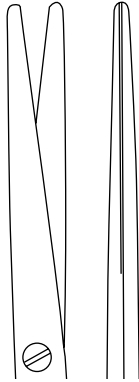
<b>11-205-14</b>	14,0 cm, 5 ½ "
------------------	----------------



**11-209-28**

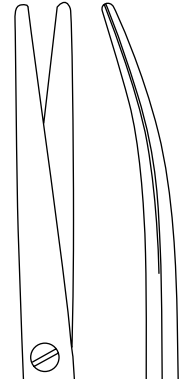
**METZENBAUM**

<b>11-209-28</b>	28,0 cm, 11 "
------------------	---------------



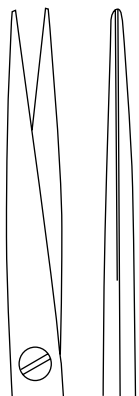
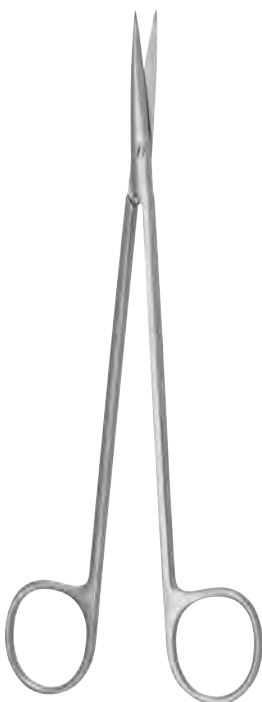
**METZENBAUM-FINO**

<b>11-210-12</b>	12,0 cm, 4 ¾ "
<b>11-210-14</b>	14,0 cm, 5 ½ "
<b>11-210-18</b>	18,0 cm, 7 "
<b>11-210-20</b>	20,0 cm, 8 "
<b>11-210-23</b>	23,0 cm, 9 "
<b>11-210-25</b>	25,0 cm, 9 ¾ "



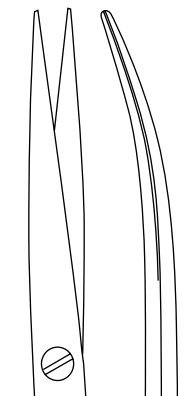
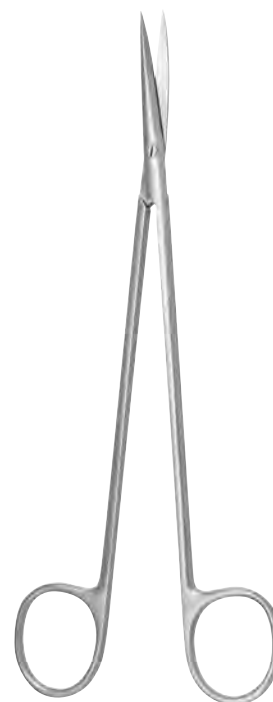
**METZENBAUM-FINO**

<b>11-211-12</b>	12,0 cm, 4 ¾ "
<b>11-211-14</b>	14,0 cm, 5 ½ "
<b>11-211-18</b>	18,0 cm, 7 "
<b>11-211-20</b>	20,0 cm, 8 "
<b>11-211-23</b>	23,0 cm, 9 "
<b>11-211-25</b>	25,0 cm, 9 ¾ "
<b>11-211-28</b>	28,0 cm, 11 "
<b>11-211-30</b>	30,0 cm, 12 "



**METZENBAUM-FINO**

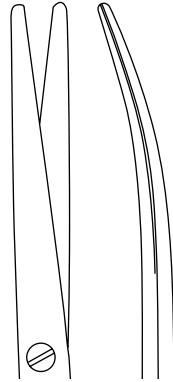
<b>11-214-14</b>	14,0 cm, 5 ½ "
<b>11-214-18</b>	18,0 cm, 7 "
<b>11-214-20</b>	20,0 cm, 8 "
<b>11-214-23</b>	23,0 cm, 9 "



**METZENBAUM-FINO**

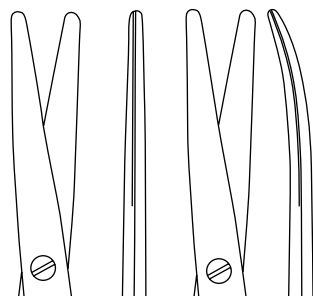
<b>11-215-14</b>	14,0 cm, 5 ½ "
<b>11-215-18</b>	18,0 cm, 7 "
<b>11-215-20</b>	20,0 cm, 8 "
<b>11-215-23</b>	23,0 cm, 9 "





### METZENBAUM-FINO-S

<b>11-221-14</b>	14,0 cm, 5 1/2 "
<b>11-221-18</b>	18,0 cm, 7 "
<b>11-221-20</b>	20,0 cm, 8 "
<b>11-221-23</b>	23,0 cm, 9 "
<b>11-221-25</b>	25,0 cm, 9 3/4 "

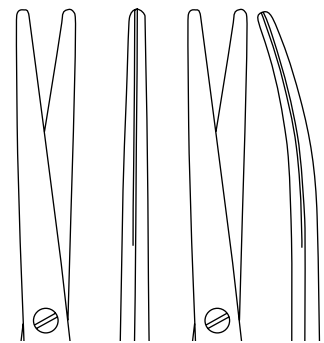


**11-226-15**

kurze Blätter  
short blades  
hojas corta  
lame corta

**11-227-15**

kurze Blätter  
short blades  
hojas corta  
lame corta



**11-228-11**

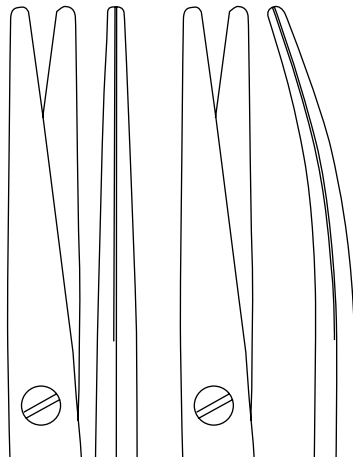
**11-229-11**

### METZENBAUM

**11-226-15 - 11-227-15** 15,0 cm, 6 "

### METZENBAUM-BABY

**11-228-11 - 11-229-11** 11,0 cm, 4 3/8 "

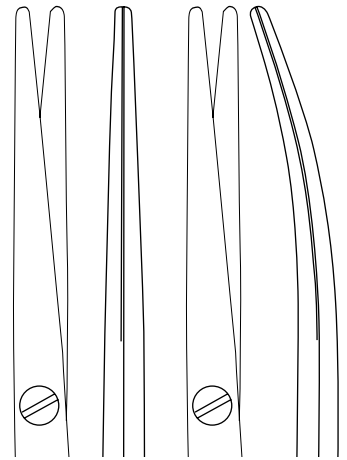


**11-230-16**

**11-231-16**

**LEXER**

**11-230-16 - 11-231-16** 16,0 cm, 6 ¼"

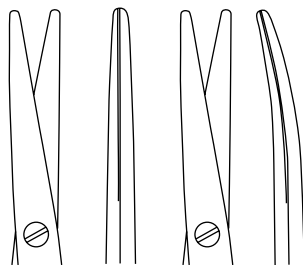


**11-232-16**

**11-233-16**

**LEXER-FINO**

**11-232-16 - 11-233-16** 16,0 cm, 6 ¼"

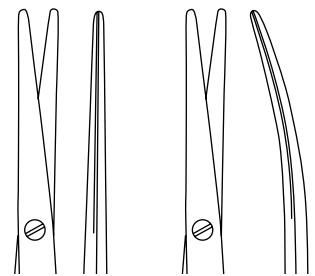


**11-234-10**

**11-235-10**

**LEXER-BABY**

**11-234-10 - 11-235-10** 10,0 cm, 4"



**11-236-09**

**11-236-11**

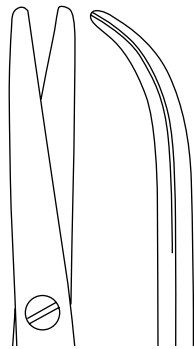
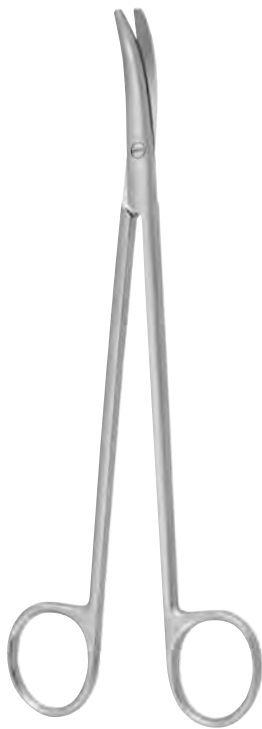
**11-237-09**

**11-237-11**

**STRABISMUS**

**11-236-09 - 11-237-09** 9,0 cm, 3 ½"

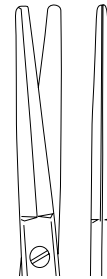
**11-236-11 - 11-237-11** 11,0 cm, 4 ¾"



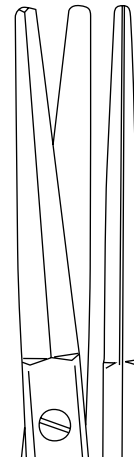
**11-241-19**  
**11-241-25**

### THOREK

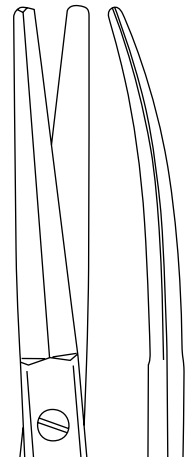
<b>11-241-19</b>	19,0 cm, 7 1/2 "
<b>11-241-25</b>	25,0 cm, 9 3/4 "



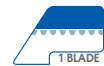
**11-242-12**



**11-242-19**



**11-243-19**



### GORNEY

<b>11-242-12</b>	12,5 cm, 5 "
<b>11-242-19 - 11-243-19</b>	19,5 cm, 7 3/4 "



**11-244-12**

### KILNER (RAGNELL)

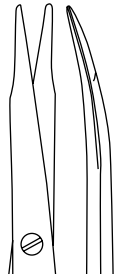
<b>11-244-12</b>	12,0 cm, 4 3/4 "
------------------	------------------



**11-245-12**  
**11-245-15**  
**11-245-18**  
**11-245-20**

### KILNER (RAGNELL)

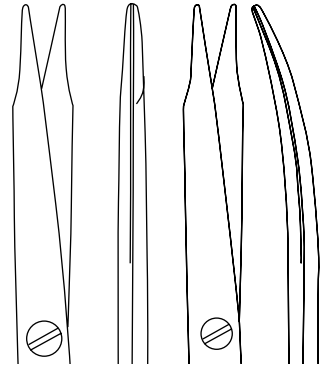
<b>11-245-12</b>	12,0 cm, 4 3/4 "
<b>11-245-15</b>	15,0 cm, 6 "
<b>11-245-18</b>	18,0 cm, 7 "
<b>11-245-20</b>	20,0 cm, 8 "



**11-247-13**  
**11-247-15**

**JAMESON**

**11-247-13** 13,0 cm, 5 1/8"  
**11-247-15** 15,0 cm, 6"

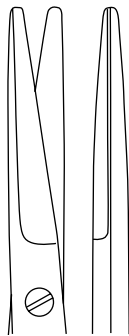
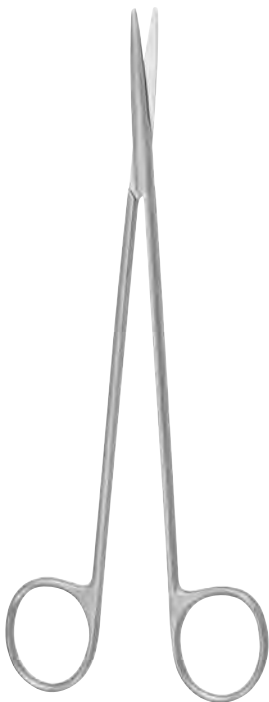


**11-248-13**  
**11-248-15**  
**11-248-18**

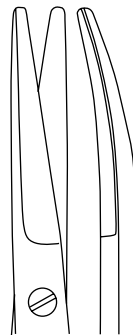
**11-249-13**  
**11-249-15**  
**11-249-18**

**REYNOLDS**

**11-248-13 - 11-249-13** 13,0 cm, 5 1/8"  
**11-248-15 - 11-249-15** 15,0 cm, 6"  
**11-248-18 - 11-249-18** 18,0 cm, 7"



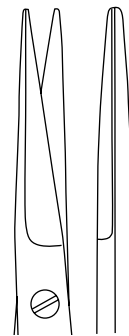
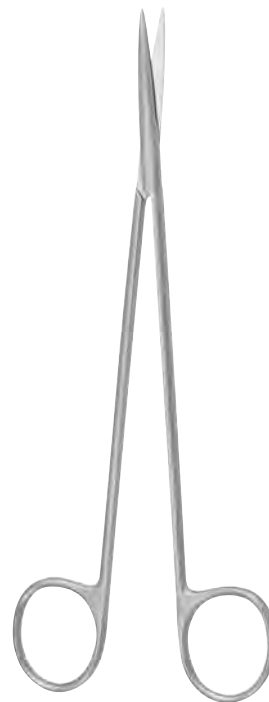
**11-250-18**



**11-251-18**

**TOENNIS**

**11-250-18 - 11-251-18** 18,0 cm, 7"



**11-252-18**

**TOENNIS-FINO**

**11-252-18** 18,0 cm, 7"

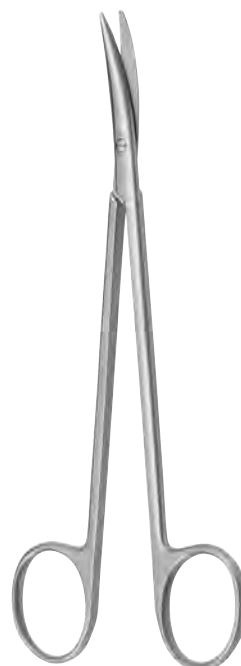


**11-253-17**



**11-255-17**

Präparierscheren  
 Dissecting scissors  
 Tijeras des disección  
 Forbici per dissezione



**11-257-17**

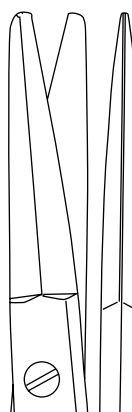
Präparierschere  
 Dissecting scissors  
 Tijera des disección  
 Forbici per dissezione

## TOENNIS-ADSON

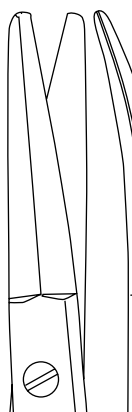
**11-253-17 - 11-255-17** 17,5 cm, 7 "

## DE BAKEY

**11-257-17** 17,5 cm, 7 "

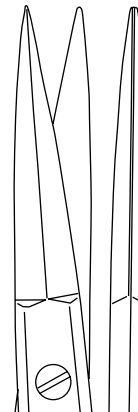


**11-300-15**



**11-301-15**

Scheren für die plastische Chirurgie  
 Plastic surgery scissors  
 Tijeras para la cirugía plástica  
 Forbici per la chirurgia plastica



**11-300-19**



**11-301-19**

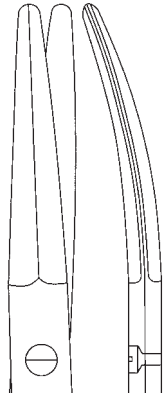
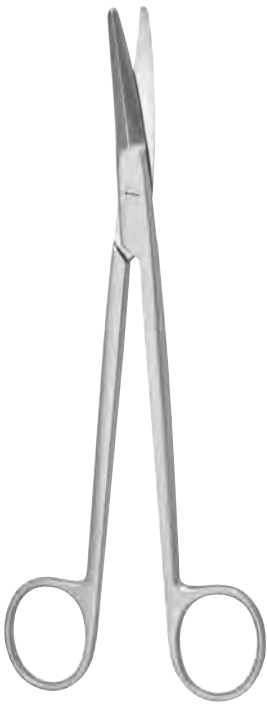
Knorpelscheren  
 Cartilage scissors  
 Tijeras para cartilago  
 Forbici per cartilagini

## AUFRICHT

**11-300-15 - 11-301-15** 15,0 cm, 6 "

## MC INDOE

**11-300-19 - 11-301-19** 19,0 cm, 7 ½ "

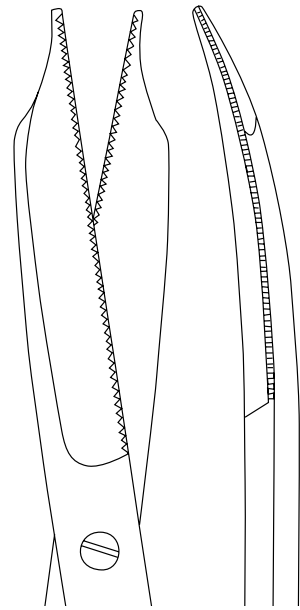
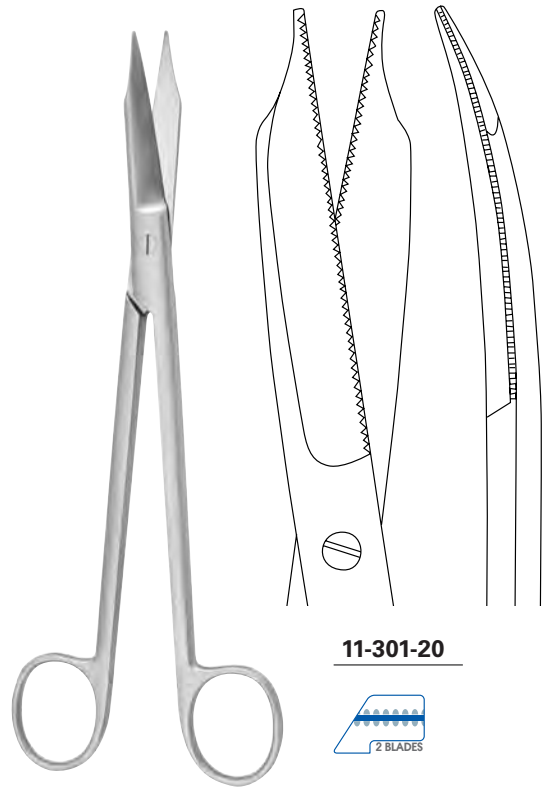


**11-301-18**

Tonsillenschiere  
 Tonsil scissors  
 Tijera para amígdalas  
 Forbici per tonsille

**BOETTCHER**

**11-301-18** 18,0 cm, 7"



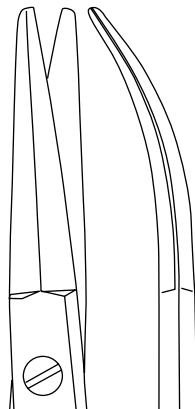
**11-301-20**



Knorpelschiere  
 Cartilage scissors  
 Tijeras para cartílago  
 Forbici per cartilagini

**MARTIN**

**11-301-20** 20,0 cm, 8"

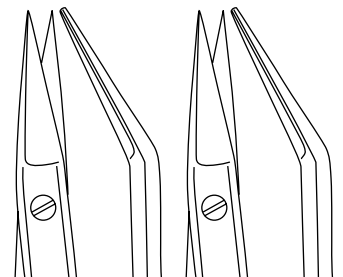


**11-303-17**

Tonsillenschiere  
 Tonsil scissors  
 Tijera para amígdalas  
 Forbici per tonsille

**PRINCE**

**11-303-17** 17,0 cm, 6 3/4"



**11-305-17**

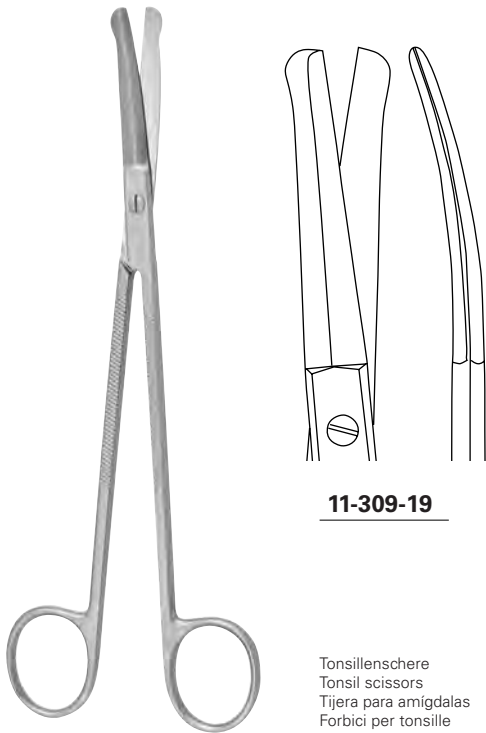
**11-307-17**



Tonsillenscheren  
 Tonsil scissors  
 Tijeras para amígdalas  
 Forbici per tonsille

**DEAN**

**11-305-17 - 11-307-17** 17,0 cm, 6 3/4"

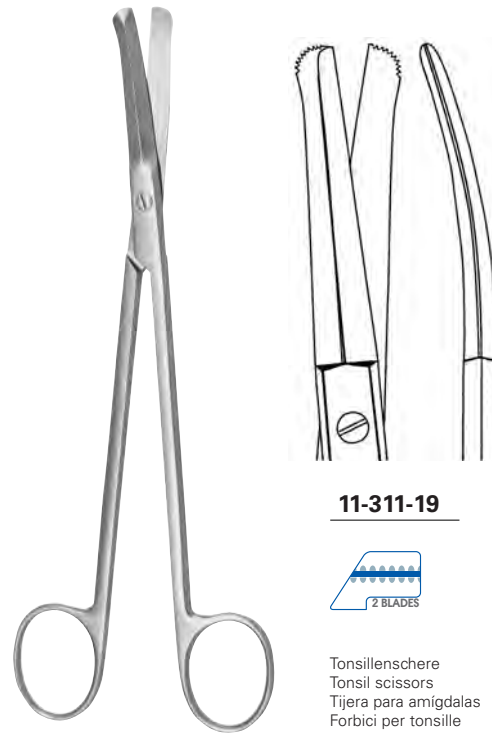


**11-309-19**

Tonsillenschere  
 Tonsil scissors  
 Tijera para amígdalas  
 Forbici per tonsille

**GOOD**

**11-309-19** 19,0 cm, 7 ½"



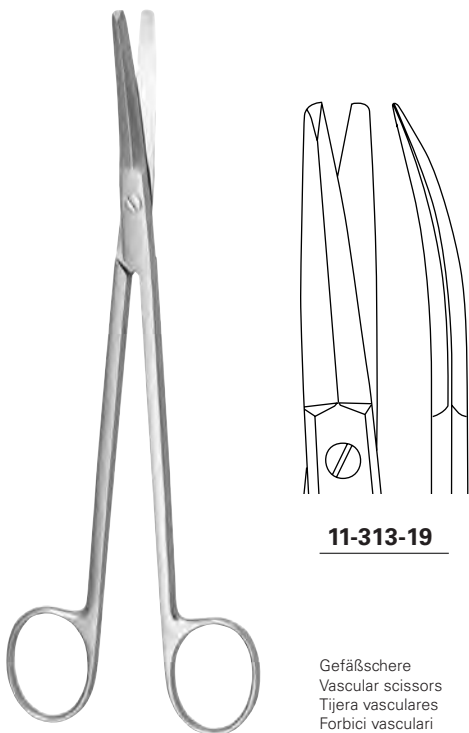
**11-311-19**



Tonsillenschere  
 Tonsil scissors  
 Tijera para amígdalas  
 Forbici per tonsille

**GOOD-SCHWEKENDIECK**

**11-311-19** 19,0 cm, 7 ½"

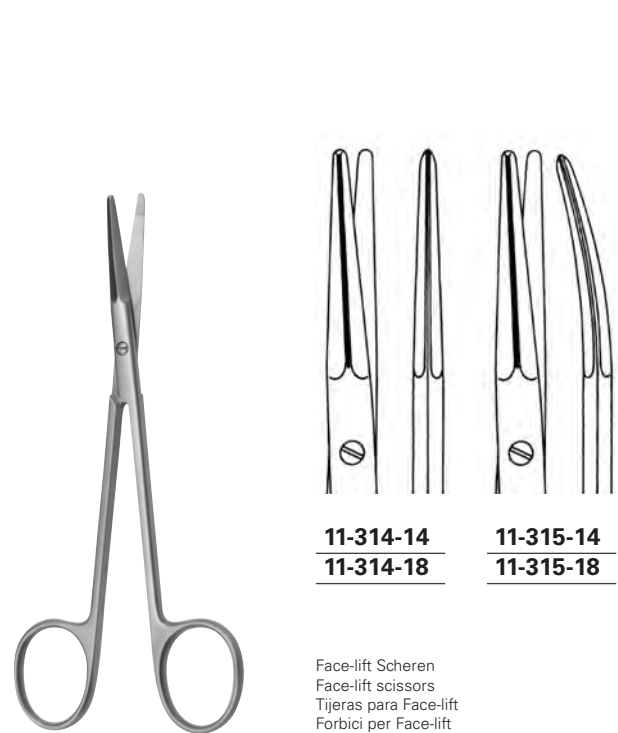


**11-313-19**

Gefäßschere  
 Vascular scissors  
 Tijera vasculares  
 Forbici vascolari

**POTTS-SMITH**

**11-313-19** 19,0 cm, 7 ½"



**11-314-14**  
**11-314-18**

**11-315-14**  
**11-315-18**

Face-lift Scheren  
 Face-lift scissors  
 Tijeras para Face-lift  
 Forbici per Face-lift

**KAHN**

**11-314-14 - 11-315-14** 14,0 cm, 5 ½"

**11-314-18 - 11-315-18** 18,0 cm, 7"

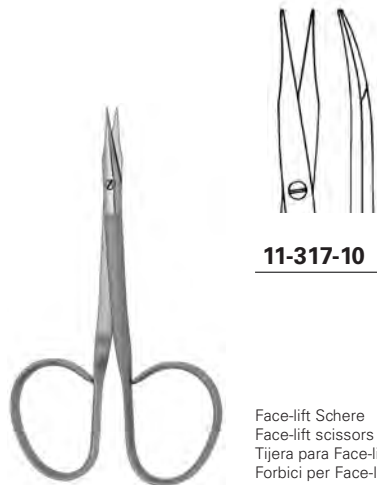


**11-317-09**

Face-lift Schere  
 Face-lift scissors  
 Tijera para Face-lift  
 Forbici per Face-lift

**SALYER**

**11-317-09** 9,5 cm, 3 ¾ "

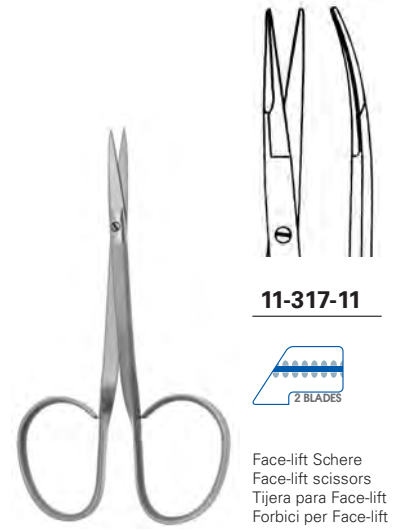


**11-317-10**

Face-lift Schere  
 Face-lift scissors  
 Tijera para Face-lift  
 Forbici per Face-lift

**SALYER**

**11-317-10** 10,0 cm, 4 "



**11-317-11**

Face-lift Schere  
 Face-lift scissors  
 Tijera para Face-lift  
 Forbici per Face-lift

**KAYE**

**11-317-11** 11,0 cm, 4 ¾ "



**11-319-13**

Nasenschere  
 Nasal scissors  
 Tijera nasales  
 Forbici nasali

**FOMON**

**11-319-13** 13,0 cm, 5 ⅛ "



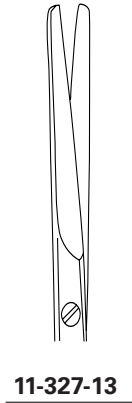
**11-321-13**

Nasenschere  
 Nasal scissors  
 Tijera nasales  
 Forbici nasali

**FOMON**

**11-321-13** 13,0 cm, 5 ⅛ "

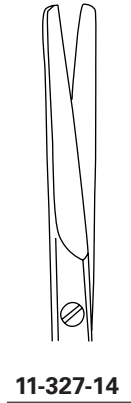




**11-327-13**

**FOMON-FINO**

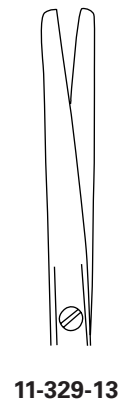
**11-327-13** 13,0 cm, 5 1/8"



**11-327-14**

**FOMON**

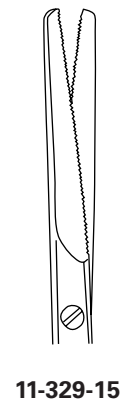
**11-327-14** 13,0 cm, 5 1/8"



**11-329-13**

**FOMON**

**11-329-13** 13,0 cm, 5 1/8"

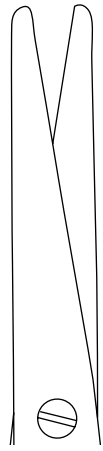


**11-329-15**



**FOMON**

**11-329-15** 15,0 cm, 6"



**11-331-16**

**COTTLE**

**11-331-16** 16,0 cm, 6 1/4"



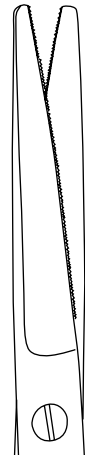
**11-333-17**  
**11-335-18**  
**11-333-20**

**HEYMANN**

**11-333-17** 17,0 cm, 6 3/4"

**11-335-18** 18,0 cm, 7"

**11-333-20** 20,0 cm, 8"

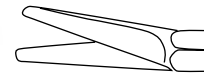


**11-337-18**



**HEYMANN**

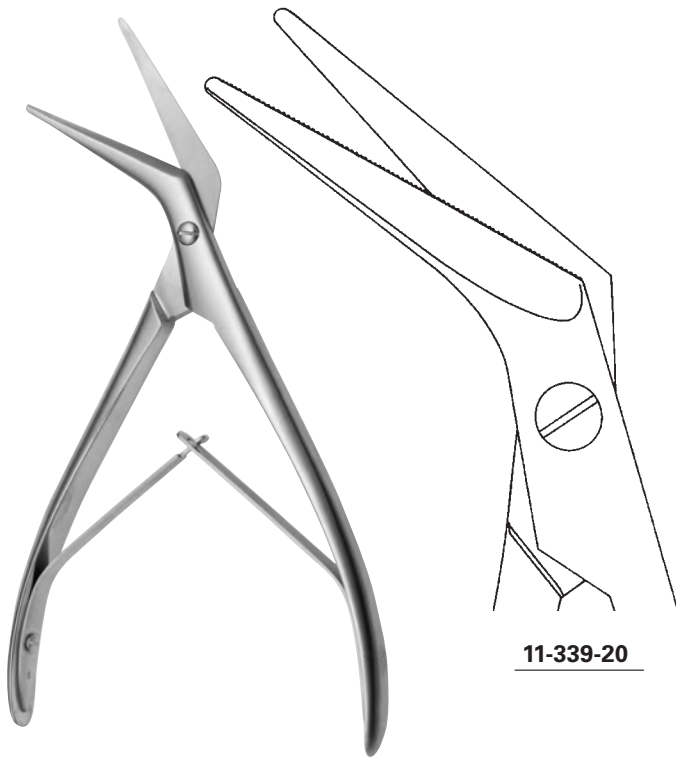
**11-337-18** 18,0 cm, 7"



**11-338-23**

**OLIVECRONA**

**11-338-23** 23,0 cm, 9"



**11-339-20**

**TESSIER**

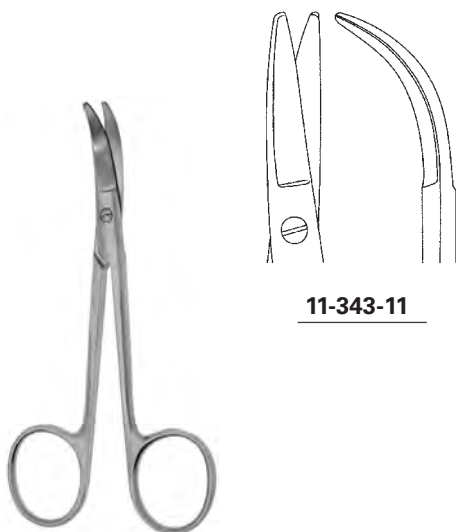
**11-339-20** 20,0 cm, 8"



**11-341-18**

**KNIGHT**

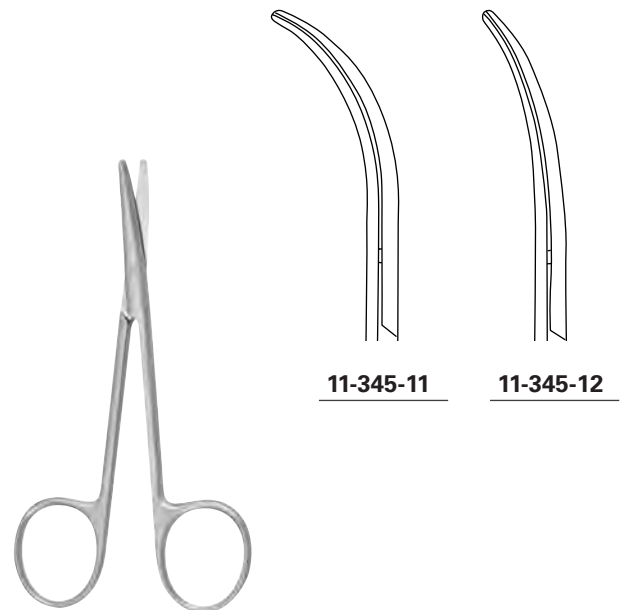
**11-341-18** 18,0 cm, 7"



**11-343-11**

**FOMON**

**11-343-11** 11,5 cm, 4 1/2"

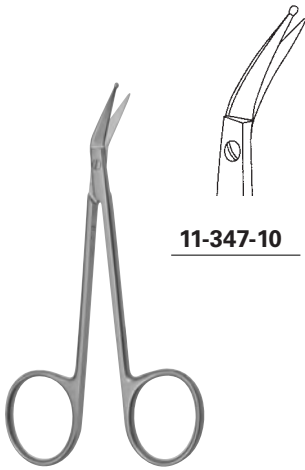


**11-345-11**

**11-345-12**

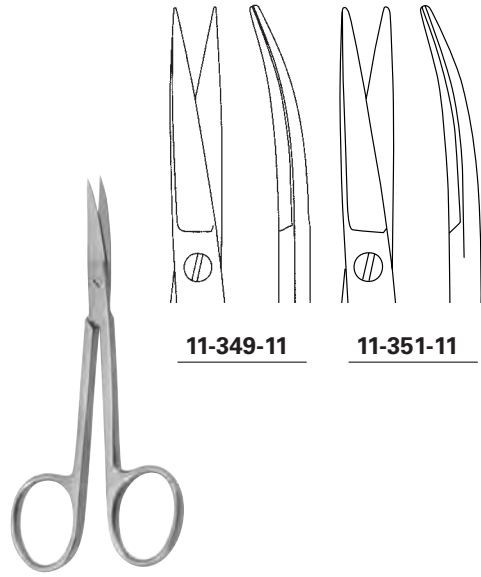
**LANDOLT**

**11-345-11 - 11-345-12** 12,0 cm, 4 3/4"



**11-347-10**

**11-347-10** 10,0 cm, 4"



**11-349-11**

**11-351-11**

**COTTLE-MASING**

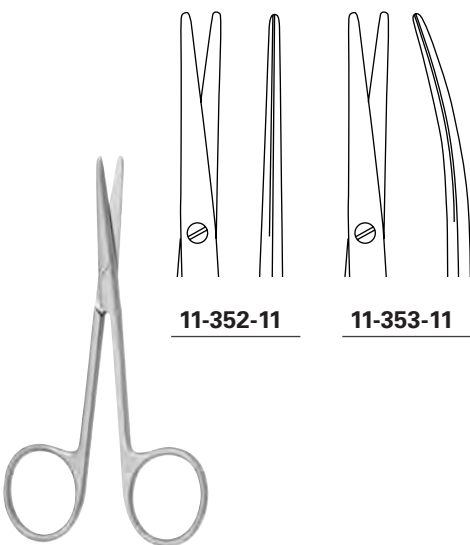
**11-349-11 - 11-351-11** 10,5 cm, 4 ¼"



**11-355-12**

**COTTLE**

**11-355-12** 11,5 cm, 4 ½"

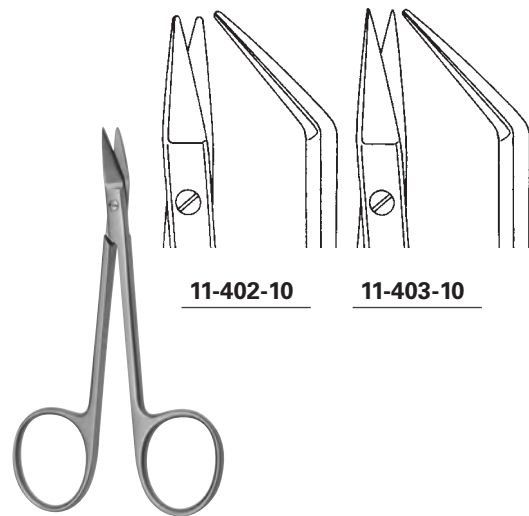


**11-352-11**

**11-353-11**

**COTTLE-KNAPP**

**11-352-11 - 11-353-11** 10,5 cm, 4 ¼"

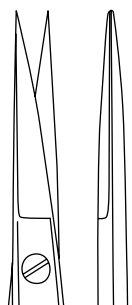
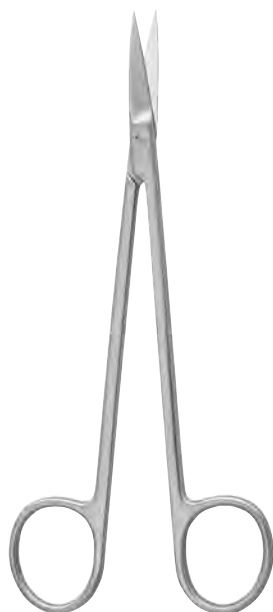


**11-402-10**

**11-403-10**

**WILMER-WALTER**

**11-402-10 - 11-403-10** 10,0 cm, 4"



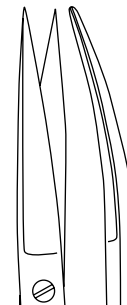
**11-400-16**  
**11-400-18**



**11-401-16**  
**11-401-18**



**11-404-14**  
**11-404-17**



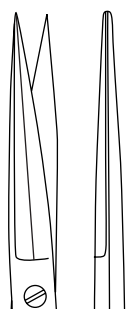
**11-405-14**  
**11-405-17**

### KELLY

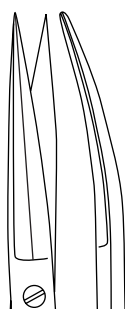
**11-400-16 - 11-401-16** 16,0 cm, 6 ¼"   
**11-400-18 - 11-401-18** 18,0 cm, 7"

### JOSEPH

**11-404-14 - 11-405-14** 14,0 cm, 5 ½"   
**11-404-17 - 11-405-17** 17,0 cm, 6 ¾"



**11-404-15**



**11-405-15**



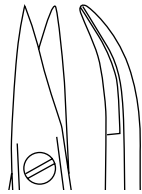
**11-407-11**

### PECK-JOSEPH

**11-404-15 - 11-405-15** 14,5 cm, 5 ⅞"

### CHADWICK

**11-407-11** 11,0 cm, 4 ⅜"

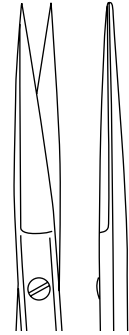


**11-407-13**

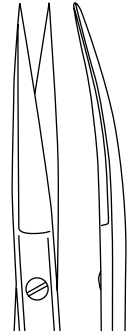
Zahnfleischschere  
 Gum scissors  
 Tijera para encías  
 Forbici per gengiva

**QUINBY**

**11-407-13** 13,0 cm, 5 1/8"



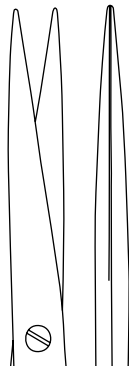
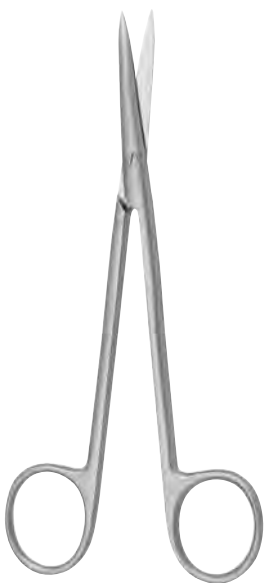
**11-408-14**



**11-409-14**

**SANVENERO**

**11-408-14 - 11-409-14** 14,0 cm, 5 1/2"

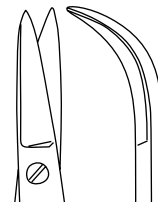


**11-410-15**



**11-411-15**

**11-410-15 - 11-411-15** 15,0 cm, 6"

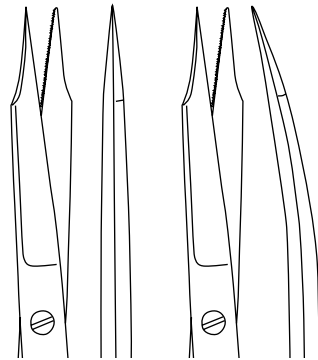


**11-413-11**

Zahnfleischschere  
 Gum scissors  
 Tijera para encías  
 Forbici per gengiva

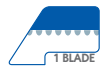
**LA GRANGE**

**11-413-11** 11,0 cm, 4 3/8"



**11-416-13**

**11-417-13**



Zahnfleissscheren  
 Gum scissors  
 Tijeras para encías  
 Forbici per gengiva

**GOLDMANN-FOX**

**11-416-13 - 11-417-13** 13,0 cm, 5 1/8 "



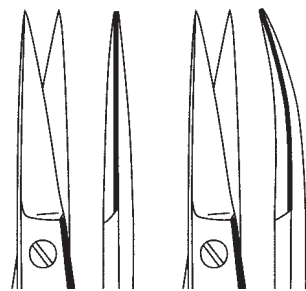
**11-417-12**



Zahnfleissschere  
 Gum scissors  
 Tijera para encías  
 Forbici per gengiva

**GOLDMANN-FOX-S**

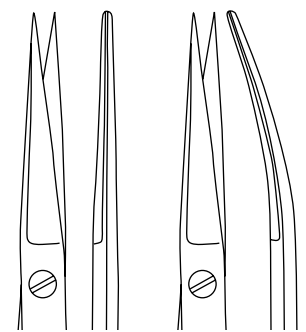
**11-417-12** 13,0 cm, 5 1/8 "



**11-418-11**

**11-419-11**

**11-418-11 - 11-419-11** 11,0 cm, 4 3/8 "



**11-426-12**

**11-427-12**

Flachschluss  
 flat screw lock  
 modelo plano  
 modello piatto

**WAGNER**

**11-426-12 - 11-427-12** 12,0 cm, 4 3/4 "

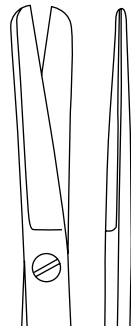


Fig. 1

**11-420-12**

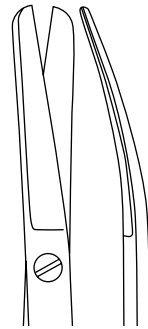


Fig. 1

**11-421-12**

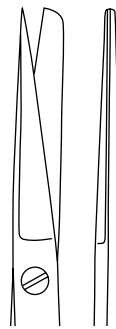


Fig. 2

**11-422-12**



Fig. 2

**11-423-12**

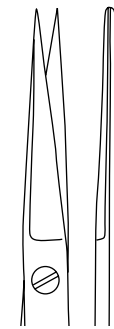


Fig. 3

**11-424-12**

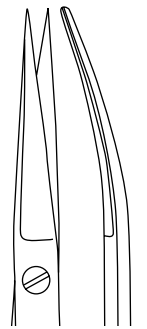


Fig. 3

**11-425-12**

**WAGNER STANDARD**

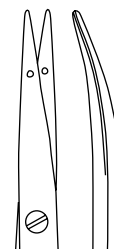
**11-420-12 - 11-425-12** 12,0 cm, 4 3/4"



**11-428-11**



**11-429-11**



**11-431-11**

**11-431-14**

**KILNER**

**11-428-11 - 11-429-11** 11,0 cm, 4 3/8"

**LITTLER**

**11-431-11** 11,0 cm, 4 3/8"

**11-431-14** 14,0 cm, 5 1/2"



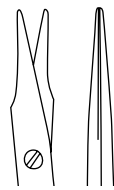


Fig. 1

**11-432-10**  
**11-432-11**

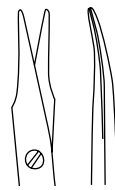


Fig. 1

**11-433-10**  
**11-433-11**



Fig. 3

**11-434-10**  
**11-434-11**

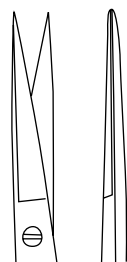


Fig. 3

**11-435-10**  
**11-435-11**

### STEVENS

**11-432-10 - 11-435-10** 10,0 cm, 4 "  
**11-432-11 - 11-435-11** 11,0 cm, 4 3/8 "



**11-436-09**  
**11-436-10**  
**11-436-11**



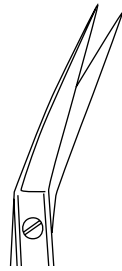
**11-437-09**  
**11-437-10**  
**11-437-11**

### IRIS

**11-436-09** 9,0 cm, 3 1/2 "  
**11-436-10** 10,0 cm, 4 "  
**11-436-11** 11,0 cm, 4 3/8 "

### IRIS

**11-437-09** 9,0 cm, 3 1/2 "  
**11-437-10** 10,0 cm, 4 "  
**11-437-11** 11,0 cm, 4 3/8 "



**11-438-11**



**11-439-11**



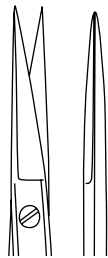
**11-439-09**

**IRIS**

**11-438-11 - 11-439-11** 11,0 cm, 4  $\frac{3}{8}$  "

**O'BRIEN**

**11-439-09** 9,0 cm, 3  $\frac{1}{2}$  "



**11-440-09**  
**11-440-10**  
**11-440-11**  
**11-440-12**



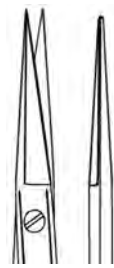
**11-441-09**  
**11-441-10**  
**11-441-11**  
**11-441-12**

**IRIS STANDARD**

**11-440-09** 9,0 cm, 3  $\frac{1}{2}$  "  
**11-440-10** 10,0 cm, 4 "  
**11-440-11** 11,0 cm, 4  $\frac{3}{8}$  "  
**11-440-12** 12,0 cm, 4  $\frac{3}{4}$  "

**IRIS STANDARD**

**11-441-09** 9,0 cm, 3  $\frac{1}{2}$  "  
**11-441-10** 10,0 cm, 4 "  
**11-441-11** 11,0 cm, 4  $\frac{3}{8}$  "  
**11-441-12** 12,0 cm, 4  $\frac{3}{4}$  "



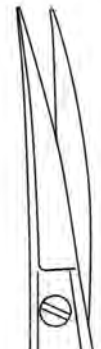
**11-442-10**  
**11-442-11**



**11-443-10**  
**11-443-11**



**11-444-11**



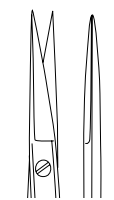
**11-445-11**

### IRIS-FINO

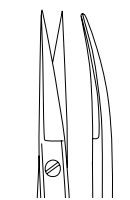
**11-442-10 - 11-443-10** 10,0 cm, 4 "  
**11-442-11 - 11-443-11** 11,0 cm, 4  $\frac{3}{8}$  "

### IRIS-ANATOMY

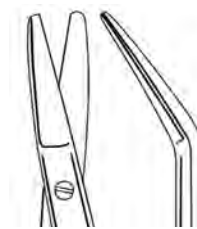
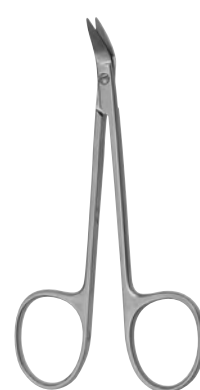
**11-444-11 - 11-445-11** 11,0 cm, 4  $\frac{3}{8}$  "



**11-446-08**  
**11-446-09**



**11-447-08**  
**11-447-09**



**11-449-10**

### BONN

**11-446-08 - 11-447-08** 8,0 cm, 3  $\frac{1}{8}$  "  
**11-446-09 - 11-447-09** 9,0 cm, 3  $\frac{1}{2}$  "

### GRAEFE

**11-449-10** 9,5 cm, 3  $\frac{3}{4}$  "

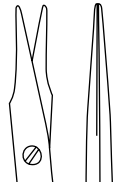


Fig. 1

**11-450-10**



Fig. 1

**11-451-10**



Fig. 3

**11-452-10**



Fig. 3

**11-453-10**

**RIBBON-STEVENS**

**11-450-10 - 11-453-10** 9,5 cm, 3 3/4"

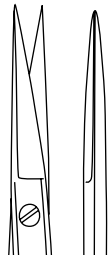


Fig. 1

**11-454-10**



Fig. 1

**11-455-10**

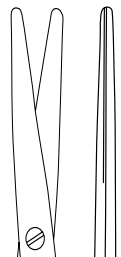


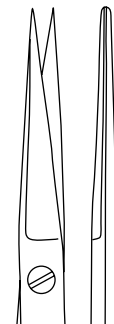
Fig. 3

**11-456-10**

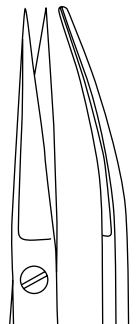


Fig. 3

**11-457-10**



**11-458-13**



**11-459-13**



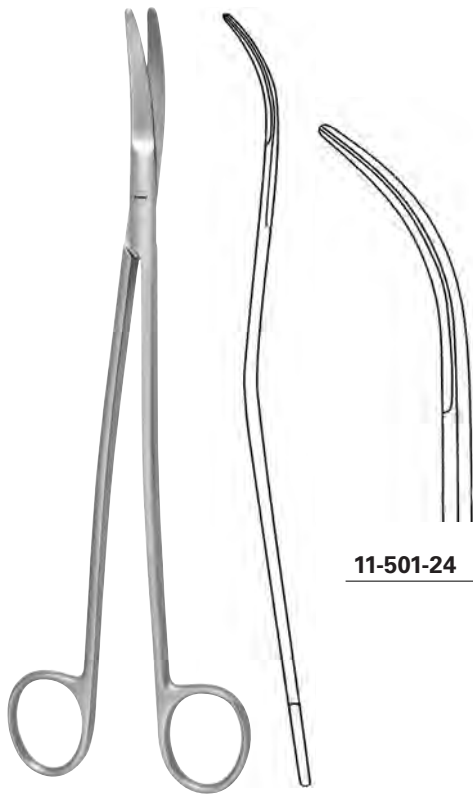
**RIBBON-IRIS**

**11-454-10 - 11-457-10** 10,0 cm, 4"



**JABALEY**

**11-458-13 - 11-459-13** 13,0 cm, 5 1/8"



**11-501-24**

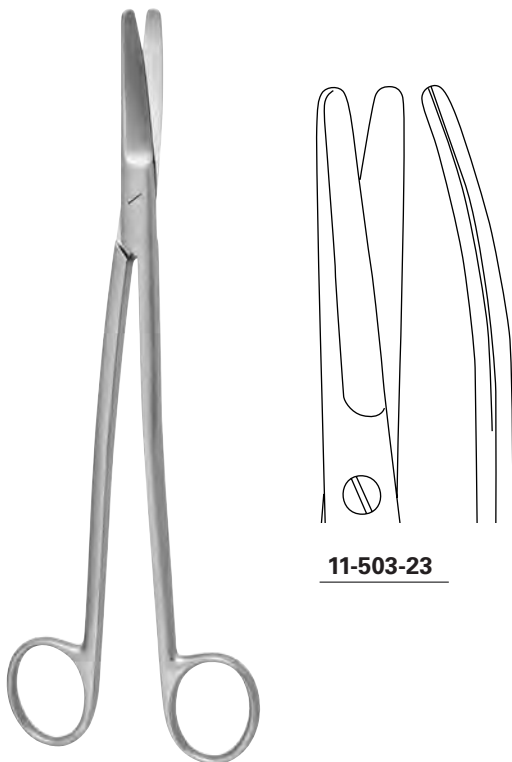
**SATINSKY**

**11-501-24** 24,0 cm, 9 1/2"



**BOZEMANN**

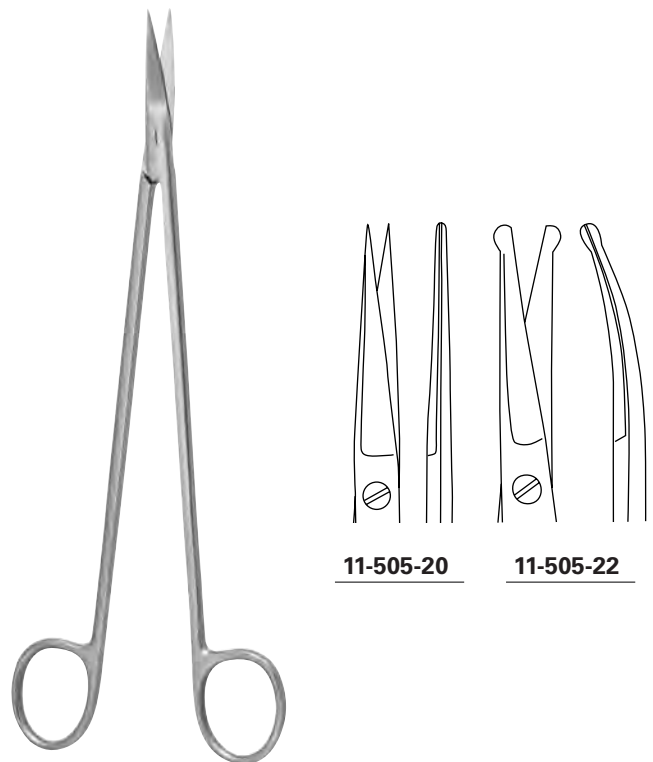
**11-502-22** 22,0 cm, 8 3/4"



**11-503-23**

**KLINKENBERGH-LOTH**

**11-503-23** 23,0 cm, 9"

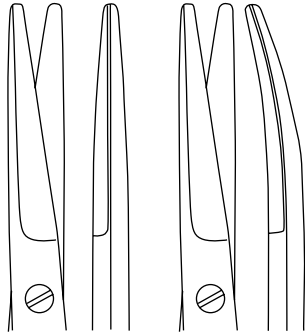


**11-505-20**

**11-505-22**

**STRULLY**

**11-505-20** 20,0 cm, 8"  
**11-505-22** 22,0 cm, 8 3/4"

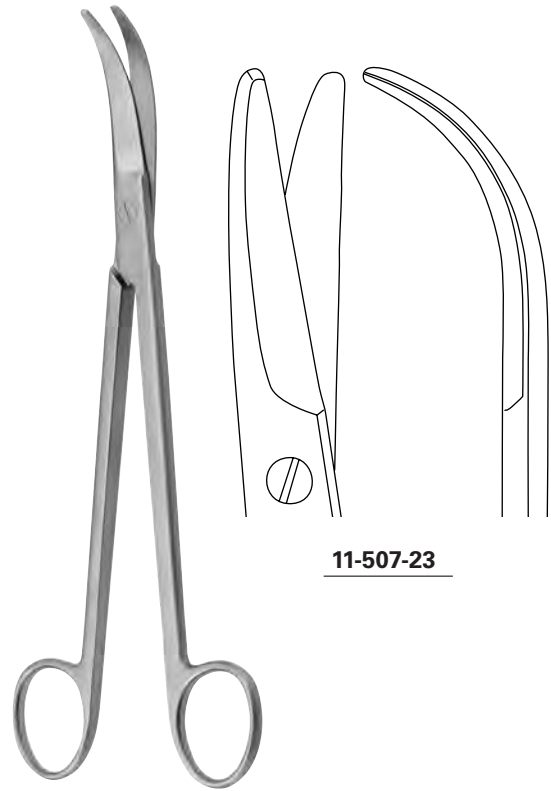


**11-506-17**

**11-507-17**

**CHURCH**

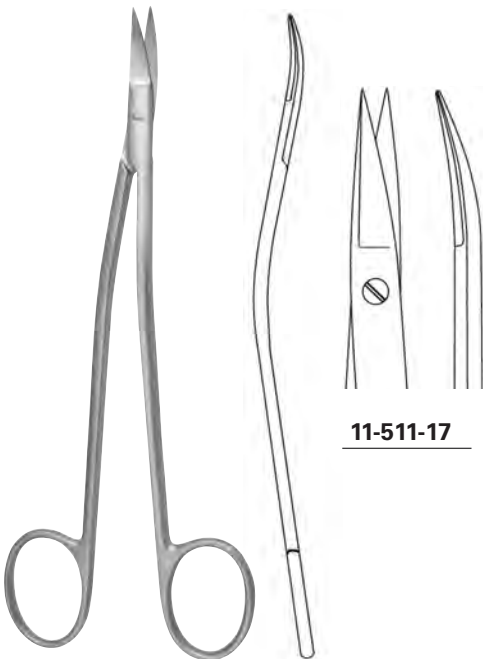
**11-506-17 - 11-507-17** 17,0 cm, 6 3/4"



**11-507-23**

**JORGENSON**

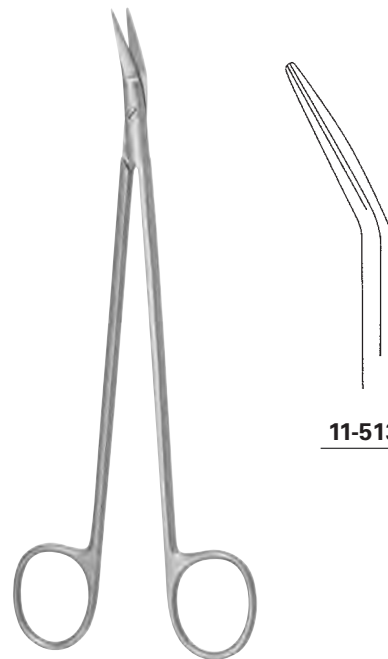
**11-507-23** 23,0 cm, 9"



**11-511-17**

**DANDY**

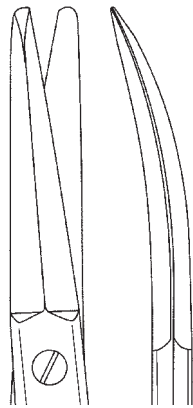
**11-511-17** 17,0 cm, 6 3/4"



**11-513-17**

**CLASSON**

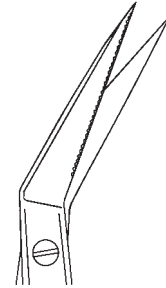
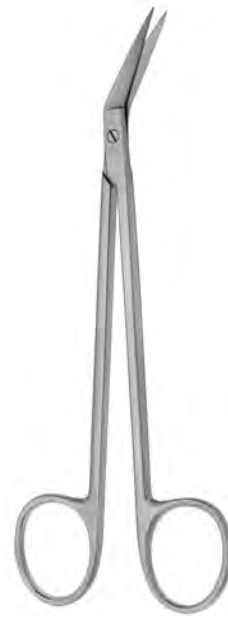
**11-513-17** 17,0 cm, 6 3/4"



**11-515-19**

**POTTS-SMITH**

**11-515-19** 19,0 cm, 7 1/2"

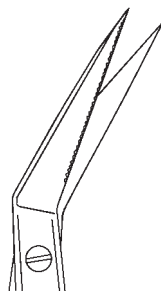


**11-519-16**



**LOCKLIN**

**11-519-16** 16,0 cm, 6 1/4"

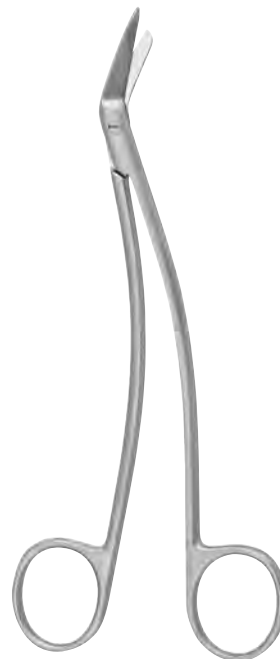


**11-521-16**



**LOCKLIN**

**11-521-16** 16,0 cm, 6 1/4"



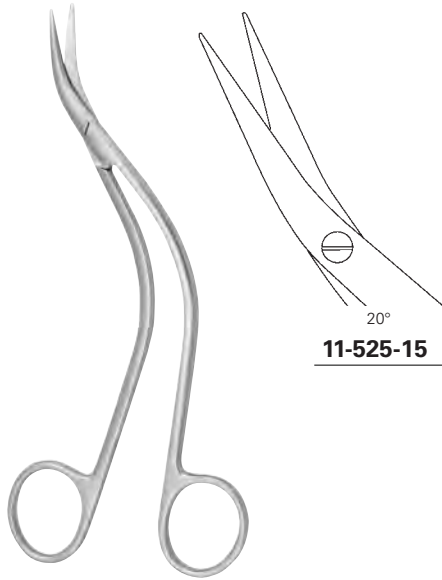
**11-523-14**

**11-523-17**

**SCHMIEDEN-TAYLOR**

**11-523-14** 14,0 cm, 5 1/2"

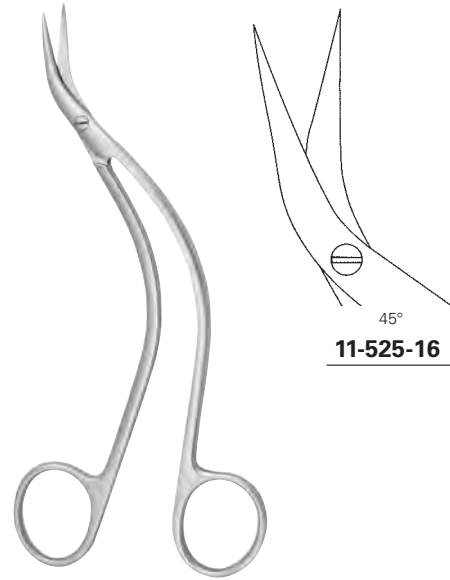
**11-523-17** 17,0 cm, 6 3/4"



**11-525-15**

**DE BAKEY**

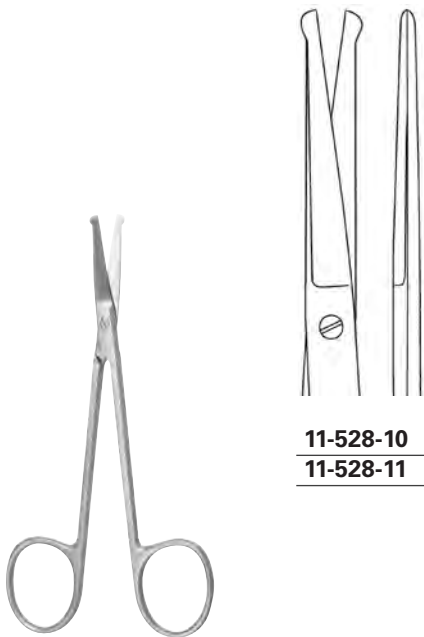
**11-525-15** 15,0 cm, 6 "



**11-525-16**

**DE BAKEY**

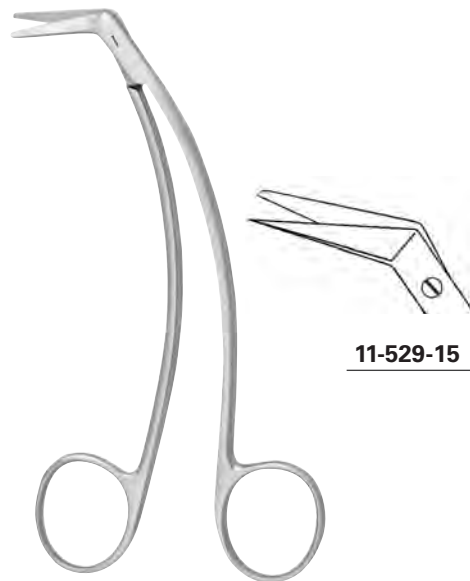
**11-525-16** 15,0 cm, 6 "



**11-528-10**  
**11-528-11**

**11-528-10** 10,0 cm, 4 "

**11-528-11** 11,0 cm, 4 3/8 "



**11-529-15**

**FAVALORO**

**11-529-15** 15,0 cm, 6 "





**11-530-11**

**11-530-11** 11,0 cm, 4 3/8"

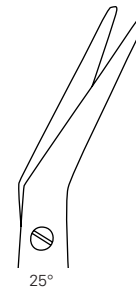
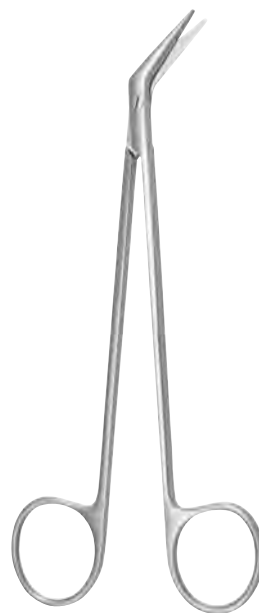


**11-531-11**

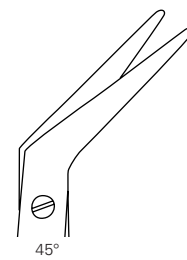
**11-531-11** 11,5 cm, 4 1/2"



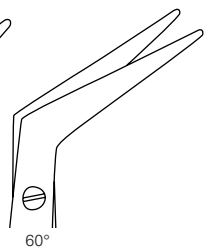
**11-532-14** 14,5 cm, 5 3/4"



**11-541-16**  
**11-541-19**  
**11-541-23**



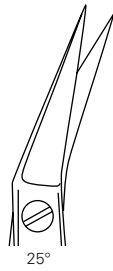
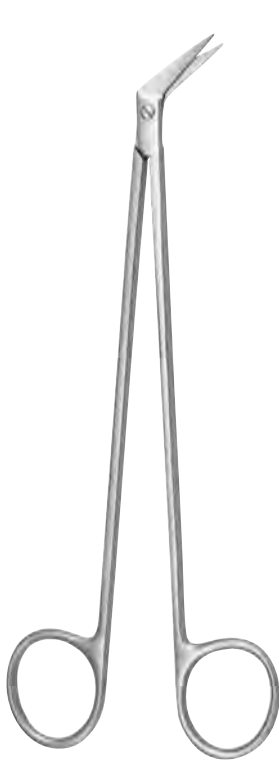
**11-543-16**  
**11-543-19**  
**11-543-23**



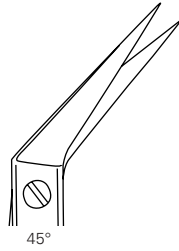
**11-545-16**  
**11-545-19**  
**11-545-23**

**DE BAKEY**

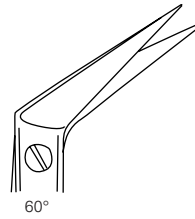
**11-541-16 - 11-545-16** 16,0 cm, 6 1/4"  
**11-541-19 - 11-545-19** 19,0 cm, 7 1/2"  
**11-541-23 - 11-545-23** 23,0 cm, 9"



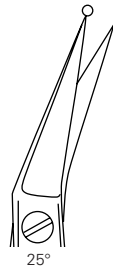
**11-551-19**



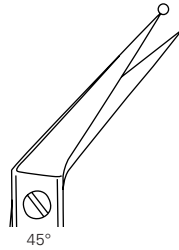
**11-553-19**



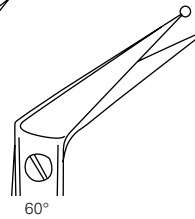
**11-555-19**



**11-561-19**



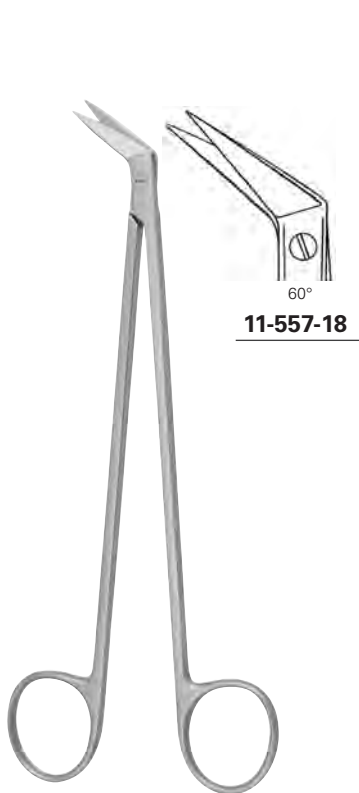
**11-563-19**



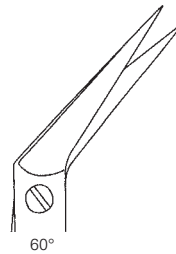
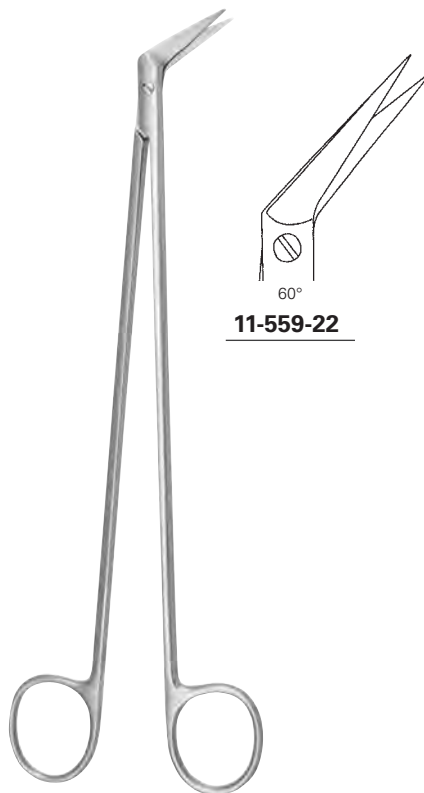
**11-565-19**

**POTTS-SMITH**

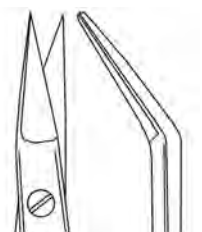
**11-551-19 - 11-565-19** 19,0 cm, 7 1/2"



**11-557-18**



**11-559-22**



**11-560-18**

**POTTS-SMITH**

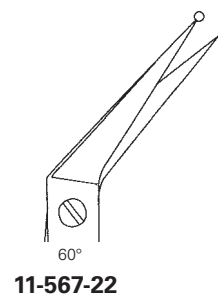
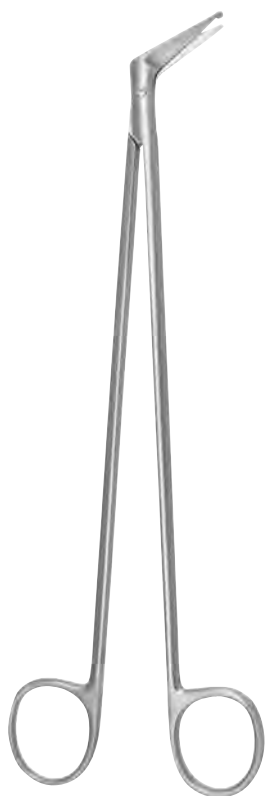
**11-557-18** 18,0 cm, 7"

**POTTS-DE MARTEL**

**11-559-22** 22,0 cm, 8 3/4"

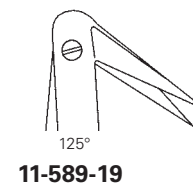
**POTTS-SMITH**

**11-560-18** 18,0 cm, 7"



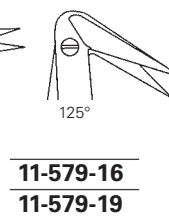
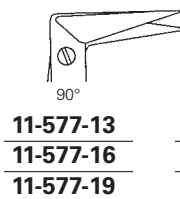
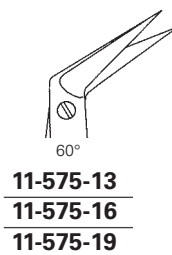
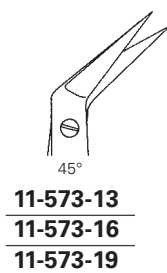
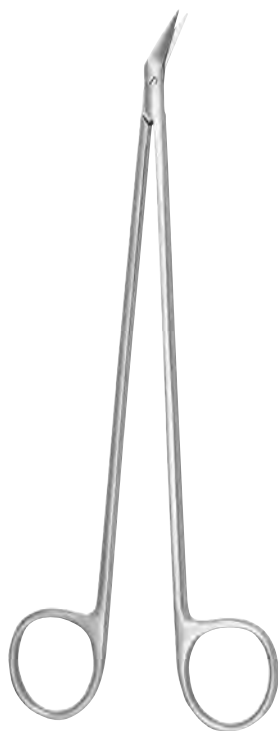
**MILLS**

**11-567-22** 22,0 cm, 8 3/4"



**HEGEMANN-DIETRICH**

**11-589-19** 19,0 cm, 7 1/2"

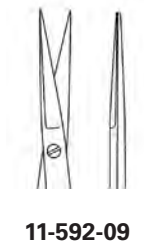
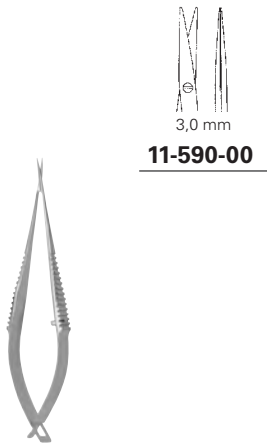


**HEGEMANN-DIETRICH**

**11-571-13 - 11-577-13** 13,0 cm, 5 1/8"

**11-571-16 - 11-579-16** 16,0 cm, 6 1/4"

**11-571-19 - 11-579-19** 19,0 cm, 7 1/2"



**MINI-VANNAS**

**11-590-00 - 11-590-01** 7,5 cm, 3"

**MINI-VANNAS**

**11-590-08 - 11-591-09** 7,5 cm, 3"

**MC CLURE**

**11-592-09** 9,5 cm, 3 3/4"



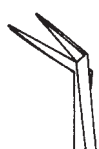
**CASTROVIEJO**

**11-593-09** 9,5 cm, 3 3/4"

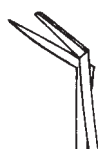
**CASTROVIEJO**

**11-593-10 - 11-593-11** 9,5 cm, 3 3/4"

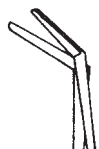
**11-594-10 - 11-594-11** 10,5 cm, 4 1/4"



**11-595-10**



**11-595-11**



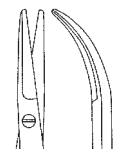
**11-595-12**



**11-596-00**



**11-596-02**



**11-597-03**



**11-597-04**



**11-597-05**

**WECKER**

**11-595-10 - 11-595-12** 11,5 cm, 4  $\frac{3}{8}$ ''

**CASTROVIEJO**

**11-596-00 - 11-597-05** 9,0 cm, 3  $\frac{1}{2}$ ''



**11-596-10**



**11-596-11**



**11-596-12**

**CASTROVIEJO**

**11-596-10** 11,0 cm, 4  $\frac{3}{8}$ ''

**CASTROVIEJO**

**11-596-11** 11,0 cm, 4  $\frac{3}{8}$ ''

**CASTROVIEJO**

**11-596-12** 11,5 cm, 4  $\frac{1}{2}$ ''



**11-596-13**



**11-597-12**



**11-597-13**

**NOYES**

**11-596-13 - 11-597-13** 12,5 cm, 5"



**11-598-11**



**11-598-12**



**11-598-13**

**NOYES**

**11-598-11 - 11-598-13** 12,5 cm, 5"



5,0 mm

**11-598-05**



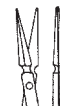
7,0 mm

**11-598-07**



**BARRAQUER**

**11-598-05 - 11-598-07** 5,5 cm, 2 1/4"



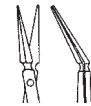
**11-599-01**



**11-599-02**



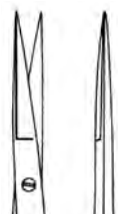
**11-599-03**



**11-599-04**

**VANNAS MOD. TUEBINGEN**

**11-599-01 - 11-599-04** 8,5 cm, 3 1/3"



**11-630-11**



**11-631-11**



**11-631-21**



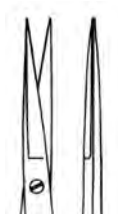
**11-631-22**

**WESTCOTT**

**11-630-11 - 11-631-11** 11,0 cm, 4  $\frac{3}{8}$  "

**WESTCOTT**

**11-631-21 - 11-631-22** 11,0 cm, 4  $\frac{3}{8}$  "



**11-632-12**



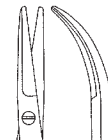
**11-633-11**



Ø 8,0 mm

**11-634-15**

**11-634-18**



Ø 8,0 mm

**11-635-15**

**11-635-18**

**11-632-11** 11,0 cm, 4  $\frac{3}{8}$  "  
**11-632-12** 12,0 cm, 4  $\frac{3}{4}$  "

**11-634-15 - 11-635-15** 15,0 cm, 6 "  
**11-634-18 - 11-635-18** 18,0 cm, 7 "



**11-635-01**

**KATZIN**

**11-635-01** 10,0 cm, 4 "



**11-635-02**

**KATZIN**

**11-635-02** 10,0 cm, 4 "



**11-635-03**

**KATZIN**

**11-635-03** 11,0 cm, 4 3/8 "



**11-635-04**

**KATZIN**

**11-635-04** 11,0 cm, 4 3/8 "



**11-635-05**

**KATZIN-BARRAQUER**

**11-635-05** 10,0 cm, 4 "



**11-635-06**

**KATZIN-BARRAQUER**

**11-635-06** 10,0 cm, 4 "





Ø 8,0 mm  
**11-687-18**

**HEPP-SCHEIDEL**

**11-687-18** 18,0 cm, 7"



Ø 8,0 mm  
**11-689-14**  
**11-689-16**

**GOMEL**

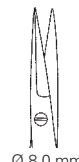
**11-689-14** 14,0 cm, 5 ½"  
**11-689-16** 16,0 cm, 6 ¼"



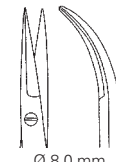
Ø 8,0 mm  
**11-691-14**  
**11-691-16**

**HEPP-SCHEIDEL**

**11-691-14** 14,0 cm, 5 ½"  
**11-691-16** 16,0 cm, 6 ¼"



Ø 8,0 mm  
**11-696-14**



Ø 8,0 mm  
**11-697-14**

**11-696-14 - 11-697-14** 14,5 cm, 5 ¾"



# 11

Mikro Instrumente  
Micro Instruments  
Instrumentos de micro  
Strumentario micro





**SPENCER-FINO**

**11-699-11** 11,0 cm, 4  $\frac{3}{8}$ "



**SPENCER**

**11-700-09** 9,0 cm, 3  $\frac{1}{2}$ "  
**11-700-11** 11,0 cm, 4  $\frac{3}{8}$ "  
**11-700-13** 12,5 cm, 5"



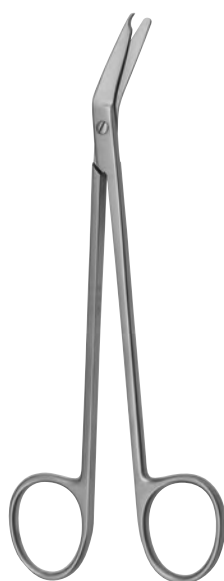
**SPENCER**

**11-701-11** 11,0 cm, 4  $\frac{3}{8}$ "



**SHORTBENT**

**11-703-09** 9,0 cm, 3  $\frac{1}{2}$ "



**LOCKLIN**

**11-703-15** 15,0 cm, 6"



**NORTHBENT**

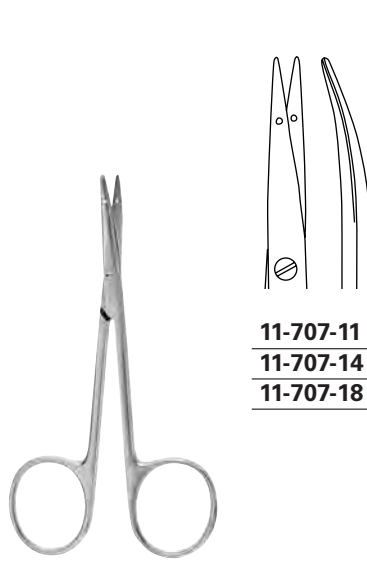
**11-705-13** 13,0 cm, 5  $\frac{1}{8}$ "



**11-706-14**

**LITTAUER**

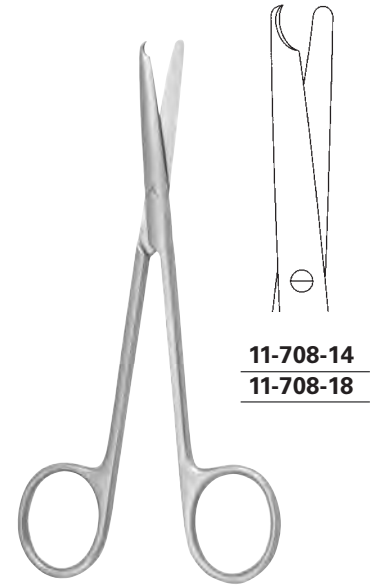
**11-706-14** 14,0 cm, 5 1/2"



**11-707-11**  
**11-707-14**  
**11-707-18**

**LITTLER**

**11-707-11** 11,0 cm, 4 3/8"  
**11-707-14** 14,0 cm, 5 1/2"  
**11-707-18** 18,0 cm, 7"



**11-708-14**  
**11-708-18**

**BUCK**

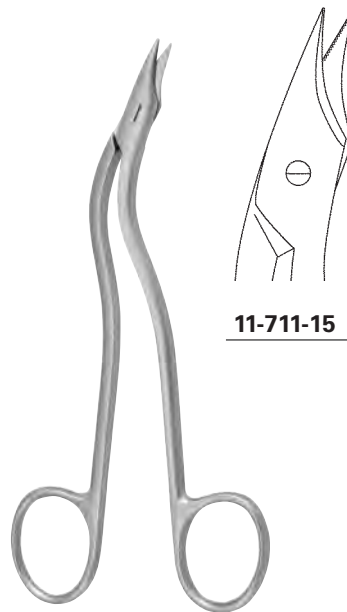
**11-708-14** 14,0 cm, 5 1/2"  
**11-708-18** 18,0 cm, 7"



**11-710-12**

**EISELSBERG**

**11-710-12** 12,0 cm, 4 3/4"



**11-711-15**

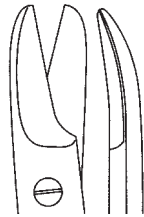
**HEATH**

**11-711-15** 15,0 cm, 6"



**SCHOEMAKER-LOTH**

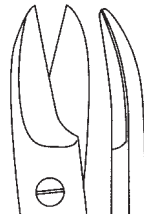
**11-712-12** 12,0 cm, 4 3/4"



**11-715-10**



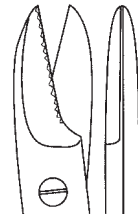
**11-716-10**



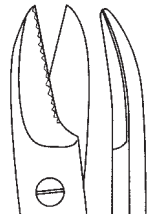
**11-717-10**



**11-715-12**



**11-716-12**



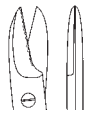
**11-717-12**



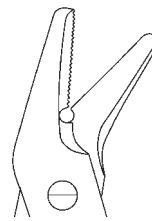
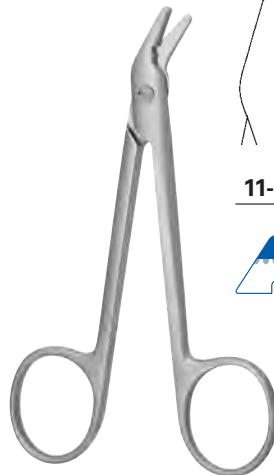
**BEEBEE**

**11-715-10 - 11-717-10** 10,0 cm, 4"

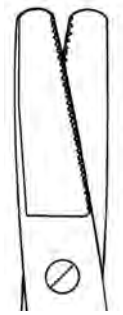
**11-715-12 - 11-717-12** 12,0 cm, 4 3/4"



**11-719-12**



**11-721-12**



**11-722-12**



**GUILFORD-WRIGHT**

**11-719-12** 10,0 cm, 4"

**UNIVERSAL**

**11-721-12** 12,0 cm, 4 3/4"

**HARVEY**

**11-722-12** 12,0 cm, 4 3/4"



# 11

SUPERCUT Scheren

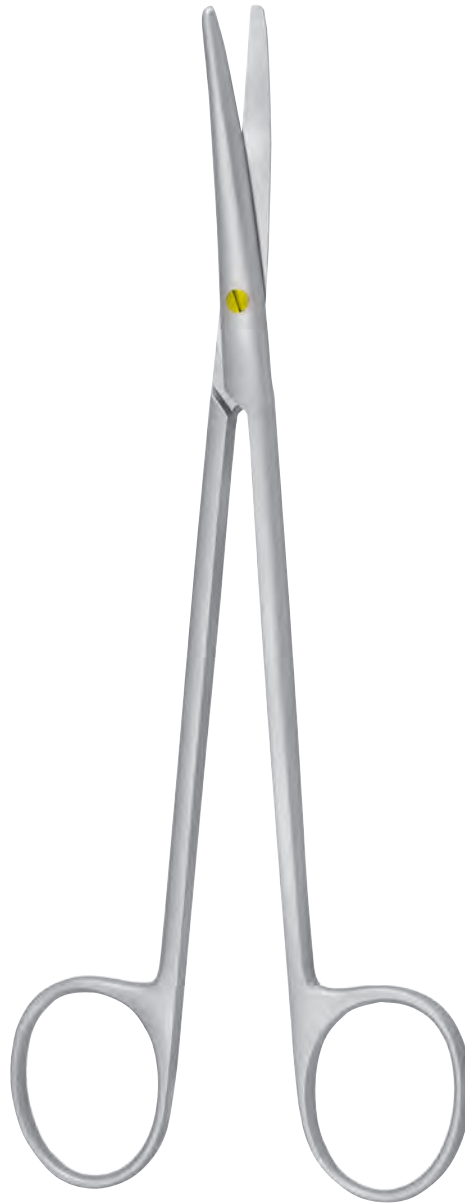
SUPERCUT scissors

Tijeras SUPERCUT

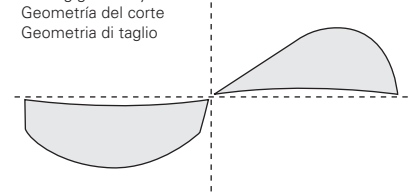
Forbici SUPERCUT



Kennzeichen: goldene Schraube  
 Characteristic: golden screw  
 Característica: tornillo dorado  
 Caratteristica: vite dorata



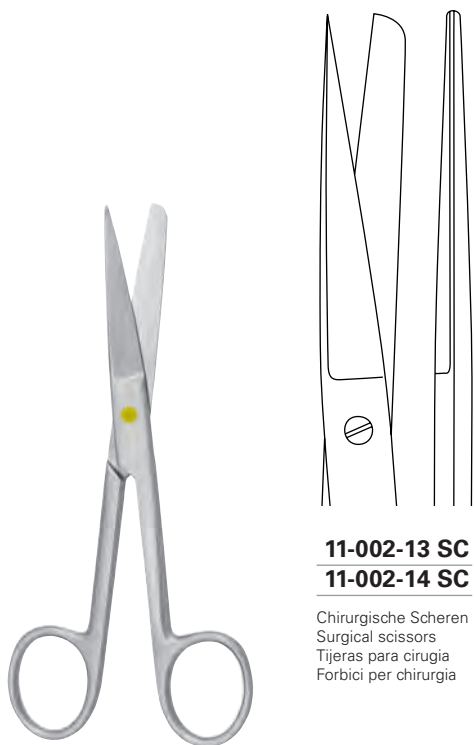
Schneidegeometrie  
 Cutting geometry  
 Geometría del corte  
 Geometria di taglio



- Bei SUPERCUT Scheren hat ein Blatt die Schneidegeometrie eines Messers, was einen mühelosen, messerartigen und glatten Schnitt ermöglicht.
- Die Mikroverzahnung am anderen Scherenblatt verhindert das Abgleiten des Gewebes.
- SUPERCUT Scissors have one razor blade which allows an easy and clean cut.
- The micro serration at the opposite blade prevents sliding off the tissue.
- Las tijeras SUPERCUT tienen una hoja geométrica cortante, lo que posibilita un corte liso y sin esfuerzo en el tejido.
- El microdentado opuesto a la hoja lisa disminuye el deslizamiento del tejido.
- Le forbici SUPERCUT hanno una lama con sezione a coltello. Questo rende facile anche il taglio del tessuto meno delicato.
- La microdentellatura nell'altra lama garantisce una presa sicura del tessuto da tagliare.

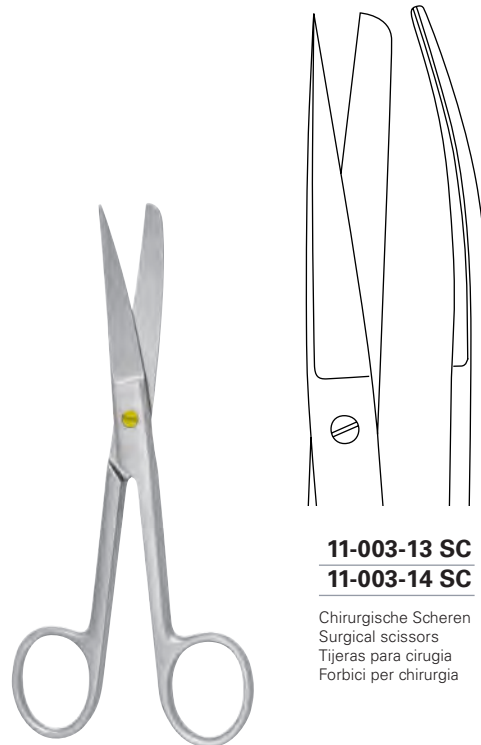






**11-002-13 SC**  
**11-002-14 SC**

Chirurgische Scheren  
 Surgical scissors  
 Tijeras para cirugía  
 Forbici per chirurgia



**11-003-13 SC**  
**11-003-14 SC**

Chirurgische Scheren  
 Surgical scissors  
 Tijeras para cirugía  
 Forbici per chirurgia

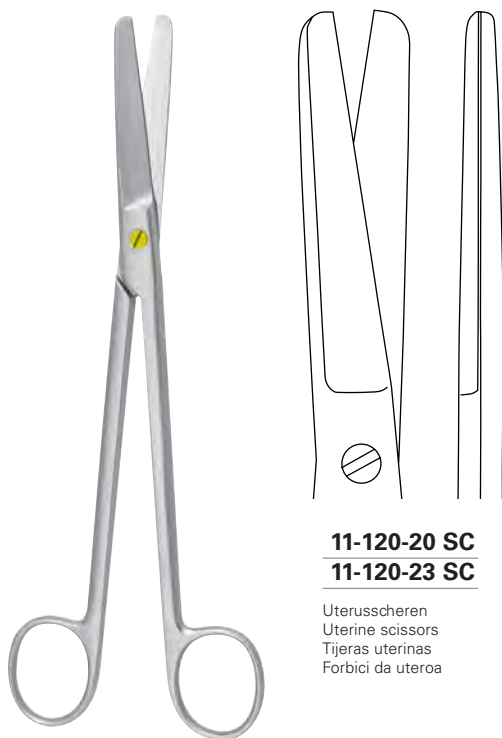
**STANDARD Fig. 2**

**11-002-13 SC** 13,0 cm, 5 1/8"  
**11-002-14 SC** 14,0 cm, 5 1/2"



**STANDARD Fig. 2**

**11-003-13 SC** 13,0 cm, 5 1/8"  
**11-003-14 SC** 14,0 cm, 5 1/2"



**11-120-20 SC**  
**11-120-23 SC**

Uterusscheren  
 Uterine scissors  
 Tijeras uterinas  
 Forbici da uteroa



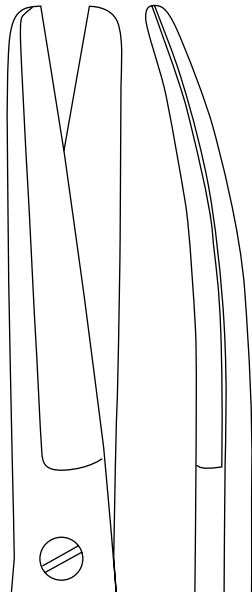
**11-121-20 SC**  
**11-121-23 SC**

Uterusscheren  
 Uterine scissors  
 Tijeras uterinas  
 Forbici da uteroa

**SIMS**

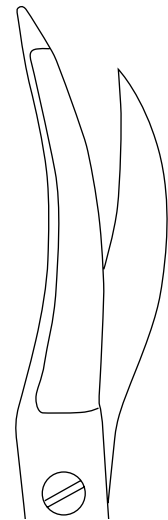
**11-120-20 SC - 11-121-20 SC** 20,0 cm, 8"  
**11-120-23 SC - 11-121-23 SC** 23,0 cm, 9"





**11-127-24 SC**

Uterusschere  
 Uterine scissors  
 Tijera uterinas  
 Forbici da uteroa



**11-141-18 SC**

Damm Schere (Episiotomie)  
 Perineum scissors (Episiotomy)  
 Tijeras para perineo (episiotomia)  
 Forbici per perineo (episiotomia)

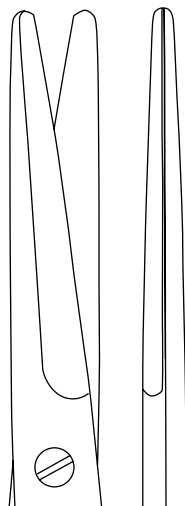
**SIMS-SIEBOLD-S**

**11-127-24 SC** 24,0 cm, 9 1/2 "



**WALDMANN**

**11-141-18 SC** 18,0 cm, 7 "

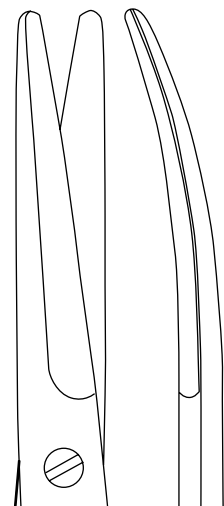


**11-160-14 SC**  
**11-160-15 SC**  
**11-160-17 SC**  
**11-160-23 SC**

Chirurgische Scheren  
 Surgical scissors  
 Tijeras para cirugia  
 Forbici per chirurgia

**MAYO**

**11-160-14 SC** 14,0 cm, 5 1/2 "  
**11-160-15 SC** 15,0 cm, 6 "  
**11-160-17 SC** 17,0 cm, 6 3/4 "  
**11-160-23 SC** 23,0 cm, 9 "



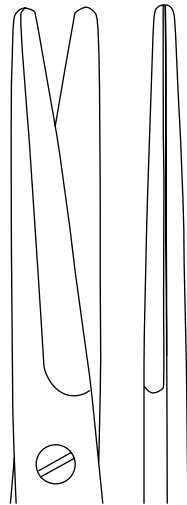
**11-161-14 SC**  
**11-161-15 SC**  
**11-161-17 SC**  
**11-161-23 SC**

Chirurgische Scheren  
 Surgical scissors  
 Tijeras para cirugia  
 Forbici per chirurgia

**MAYO**

**11-161-14 SC** 14,0 cm, 5 1/2 "  
**11-161-15 SC** 15,0 cm, 6 "  
**11-161-17 SC** 17,0 cm, 6 3/4 "  
**11-161-23 SC** 23,0 cm, 9 "





**11-166-22 SC**

Chirurgische Schere  
 Surgical scissors  
 Tijera para cirugía  
 Forbici per chirurgia

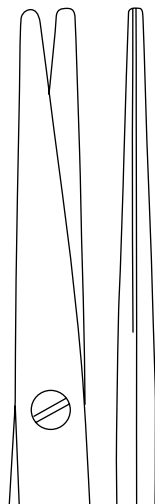


**11-167-22 SC**

Chirurgische Schere  
 Surgical scissors  
 Tijera para cirugía  
 Forbici per chirurgia

**MAYO-HARRINGTON**

**11-166-22 SC - 11-167-22 SC** 22,0 cm, 8 3/4"



**11-170-15 SC**  
**11-170-17 SC**

Chirurgische Scheren  
 Surgical scissors  
 Tijeras para cirugía  
 Forbici per chirurgia



**11-171-15 SC**  
**11-171-17 SC**

Chirurgische Scheren  
 Surgical scissors  
 Tijeras para cirugía  
 Forbici per chirurgia

**MAYO-STILLE**

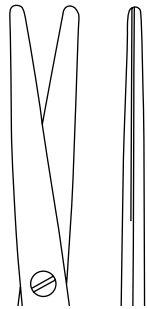
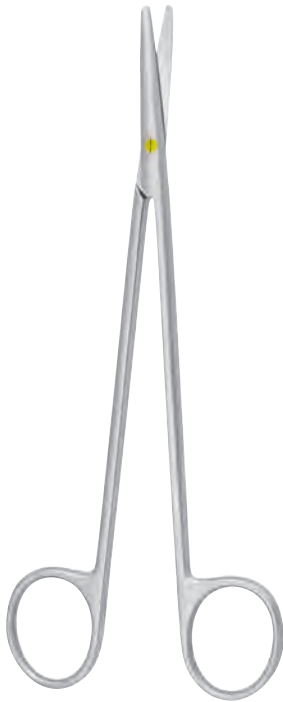
**11-170-15 SC** 15,0 cm, 6"  
**11-170-17 SC** 17,0 cm, 6 3/4"



**MAYO-STILLE**

**11-171-15 SC** 15,0 cm, 6"  
**11-171-17 SC** 17,0 cm, 6 3/4"



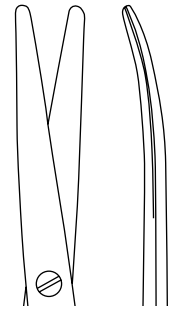


Präparierscheren  
 Dissecting scissors  
 Tijeras des disección  
 Forbici per dissezione



**METZENBAUM**

<b>11-200-14 SC</b>	14,0 cm, 5 1/2 "
<b>11-200-18 SC</b>	18,0 cm, 7 "
<b>11-200-20 SC</b>	20,0 cm, 8 "
<b>11-200-23 SC</b>	23,0 cm, 9 1/2 "
<b>11-200-25 SC</b>	25,0 cm, 9 3/4 "
<b>11-200-30 SC</b>	30,0 cm, 11 3/4 "

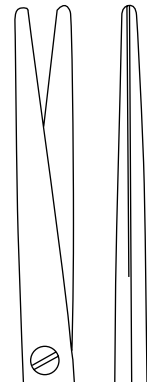


Präparierscheren  
 Dissecting scissors  
 Tijeras des disección  
 Forbici per dissezione



**METZENBAUM**

<b>11-201-14 SC</b>	14,0 cm, 5 1/2 "
<b>11-201-18 SC</b>	18,0 cm, 7 "
<b>11-201-20 SC</b>	20,0 cm, 8 "
<b>11-201-23 SC</b>	23,0 cm, 9 1/2 "
<b>11-201-25 SC</b>	25,0 cm, 9 3/4 "
<b>11-201-30 SC</b>	30,0 cm, 11 3/4 "



Präparierscheren  
 Dissecting scissors  
 Tijeras des disección  
 Forbici per dissezione



**METZENBAUM-FINO**

<b>11-210-12 SC</b>	12,0 cm, 4 3/4 "
<b>11-210-14 SC</b>	14,0 cm, 5 1/2 "
<b>11-210-18 SC</b>	18,0 cm, 7 "
<b>11-210-20 SC</b>	20,0 cm, 8 "
<b>11-210-23 SC</b>	23,0 cm, 9 1/2 "

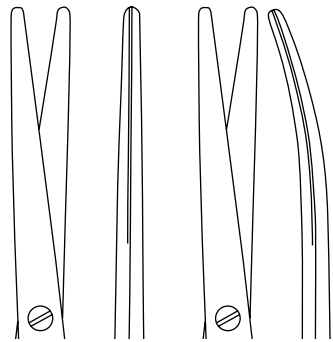


Präparierscheren  
 Dissecting scissors  
 Tijeras des disección  
 Forbici per dissezione



**METZENBAUM-FINO**

<b>11-211-12 SC</b>	12,0 cm, 4 3/4 "
<b>11-211-14 SC</b>	14,0 cm, 5 1/2 "
<b>11-211-18 SC</b>	18,0 cm, 7 "
<b>11-211-20 SC</b>	20,0 cm, 8 "
<b>11-211-23 SC</b>	23,0 cm, 9 1/2 "



**11-228-11 SC**

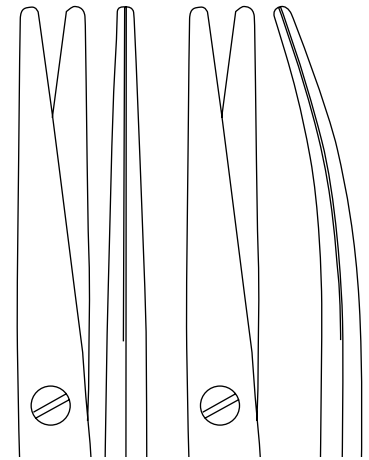
**11-229-11 SC**



Präparierscheren  
 Dissecting scissors  
 Tijeras des disección  
 Forbici per dissezione

### METZENBAUM-BABY

**11-228-11 SC - 11-229-11 SC** 11,0 cm, 4 3/8"



**11-230-16 SC**

**11-231-16 SC**



Präparierscheren  
 Dissecting scissors  
 Tijeras des disección  
 Forbici per dissezione

### LEXER

**11-230-16 SC - 11-231-16 SC** 16,0 cm, 6 1/4"



**11-245-12 SC**

Präparierscheren  
 Dissecting scissors  
 Tijeras des disección  
 Forbici per dissezione

### KILNER (RAGNELL)

**11-245-12 SC** 12,0 cm, 4 3/4"



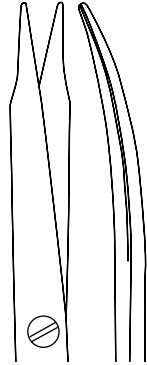
**11-247-15 SC**

Präparierscheren  
 Dissecting scissors  
 Tijeras des disección  
 Forbici per dissezione

### JAMESON

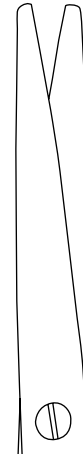
**11-247-15 SC** 15,0 cm, 6"





**11-249-13 SC**  
**11-249-15 SC**  
**11-249-18 SC**

Präparierscheren  
 Dissecting scissors  
 Tijeras des disección  
 Forbici per dissezione



**11-335-18 SC**

Nasenschere  
 Nasal scissors  
 Tijera nasales  
 Forbici nasali

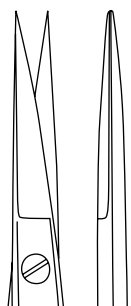
**REYNOLDS**

**11-249-13 SC** 13,0 cm, 5 1/8"  
**11-249-15 SC** 15,0 cm, 6"  
**11-249-18 SC** 18,0 cm, 7"



**HEYMANN**

**11-335-18 SC** 18,0 cm, 7"



**11-400-16 SC**



**11-401-16 SC**



Feine chirurgische Scheren  
 Delicate surgical scissors  
 Tijeras finas para cirugía  
 Forbici fine per chirurgia



**11-433-11 SC**

Feine chirurgische Schere  
 Delicate surgical scissors  
 Tijera finas para cirugía  
 Forbici fine per chirurgia

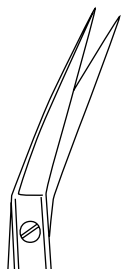
**KELLY**

**11-400-16 SC - 11-401-16 SC** 16,0 cm, 6 1/4"

**STEVENS**

**11-433-11 SC** 11,0 cm, 4 3/8"





**11-438-11 SC**

Feine chirurgische Schere  
 Delicate surgical scissors  
 Tijera finas para cirugía  
 Forbici fine per chirurgia

**IRIS**

**11-438-11 SC** 11,0 cm, 4  $\frac{3}{8}$ ''

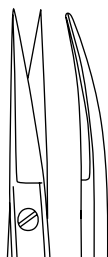


**11-440-09 SC**  
**11-440-11 SC**

Feine chirurgische Scheren  
 Delicate surgical scissors  
 Tijeras finas para cirugía  
 Forbici fine per chirurgia

**IRIS**

**11-440-09 SC** 9,0 cm, 3  $\frac{1}{2}$ ''  
**11-440-11 SC** 11,0 cm, 4  $\frac{3}{8}$ ''

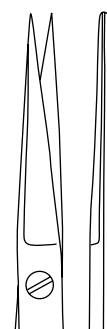


**11-441-09 SC**  
**11-441-11 SC**

Feine chirurgische Scheren  
 Delicate surgical scissors  
 Tijeras finas para cirugía  
 Forbici fine per chirurgia

**IRIS**

**11-441-09 SC** 9,0 cm, 3  $\frac{1}{2}$ ''  
**11-441-11 SC** 11,0 cm, 4  $\frac{3}{8}$ ''



**11-458-13 SC**

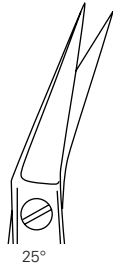
**11-459-13 SC**



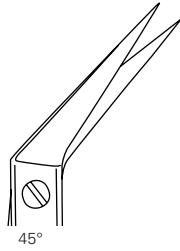
Feine chirurgische Scheren  
 Delicate surgical scissors  
 Tijeras finas para cirugía  
 Forbici fine per chirurgia

**JABALEY**

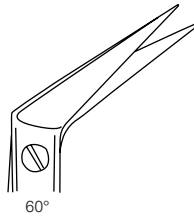
**11-458-13 SC - 11-459-13 SC** 13,0 cm, 5  $\frac{1}{8}$ ''



**11-551-19 SC**



**11-553-19 SC**



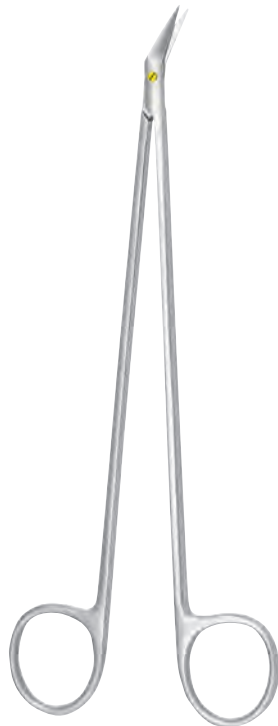
**11-555-19 SC**



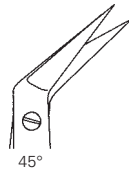
Gefäßscheren  
 Vascular scissors  
 Tijeras vasculares  
 Forbici vascolari

**POTTS-SMITH**

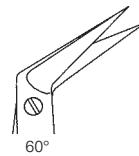
**11-551-19 SC - 11-555-19 SC** 19,0 cm, 7 1/2"



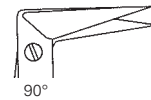
**11-571-19 SC**



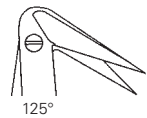
**11-573-19 SC**



**11-575-19 SC**



**11-577-19 SC**



**11-579-19 SC**



Gefäßscheren  
 Vascular scissors  
 Tijeras vasculares  
 Forbici vascolari

**HEGEMANN-DIETRICH**

**11-571-19 - 11-579-19 SC** 19,0 cm, 7 1/2"





## 12

Scheren mit Hartmetallschneiden  
Scissors with tungsten carbide edges  
Tijeras con filos de carburo tungsteno  
Forbici con lame in carburo i tungsteno



Kennzeichnung: goldene Ringe  
Characteristic: golden rings  
Característica: mangos dorados  
Caratteristica: anelli dorata

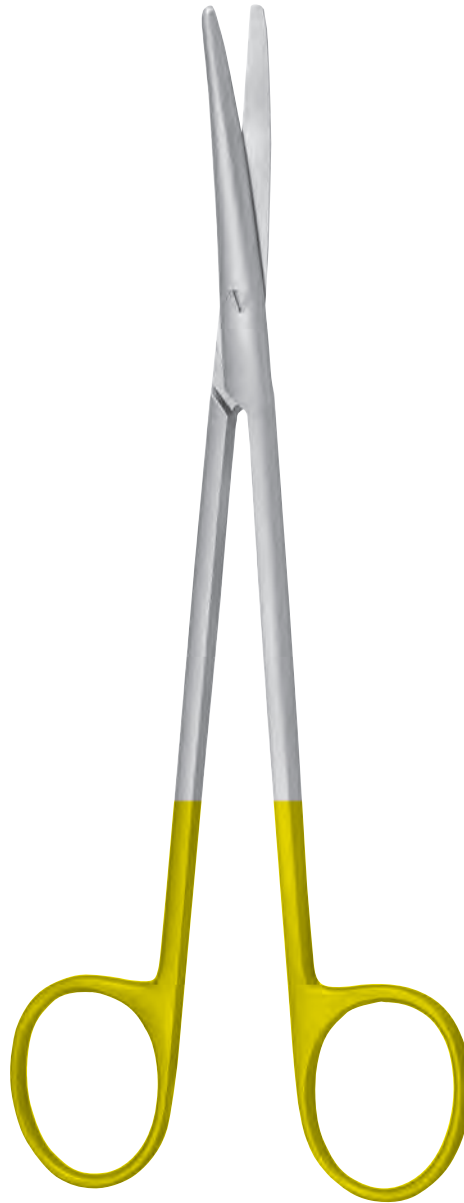
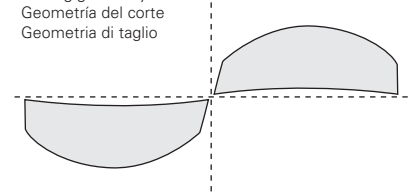


Ausführungen | Specification  
Especificación | Specifica



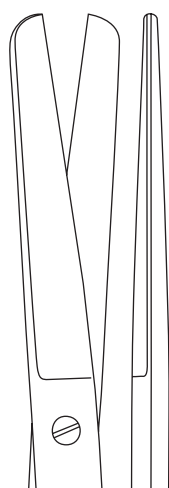
1 Schneide gezahnt  
1 serrated blade  
1 hoja dentada  
1 lama dentata

Schneidegeometrie  
Cutting geometry  
Geometría del corte  
Geometria di taglio



- Aufgeschweißte Hartmetallschneiden, daher keine zur Korrosion neigende Lötnaht
- Dauerhaft scharfer Schnitt
- Gleichmäßiger, weicher Gang
- Welded tungsten carbide cutting edges, therefore no seam tending to corrosion
- Durable sharp cutting edge
- Regular and smooth function
- Filos de carburo de tungsteno soldados, por eso sin soldadura tendiente a la corrosión.
- Agudeza del corte durable
- Corte suave y regular
- Parti taglianti in carburo di tungsteno saldate e di conseguenza nessuna tendenza alla corrosione
- Taglio eccellente di lunga durata
- Funzionamento armonico e dolce





**12-000-14**  
**12-000-16**  
**12-000-18**



**STANDARD Fig. 1**

<b>12-000-14</b>	14,0 cm, 5 1/2"
<b>12-000-16</b>	16,0 cm, 6 1/4"
<b>12-000-18</b>	18,0 cm, 7"



**12-001-14**  
**12-001-16**  
**12-001-18**

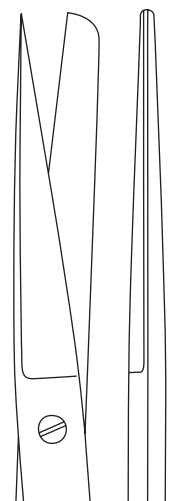
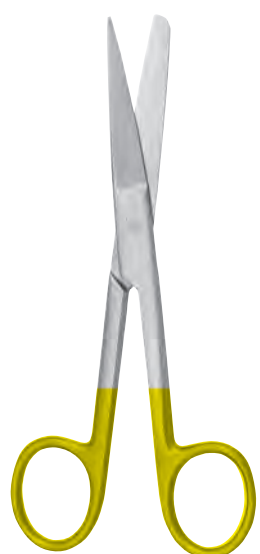


**STANDARD Fig. 1**

<b>12-001-14</b>	14,0 cm, 5 1/2"
<b>12-001-16</b>	16,0 cm, 6 1/4"
<b>12-001-18</b>	18,0 cm, 7"

**STANDARD Fig. 1**

<b>12-001-14 W</b>	14,0 cm, 5 1/2"
--------------------	-----------------

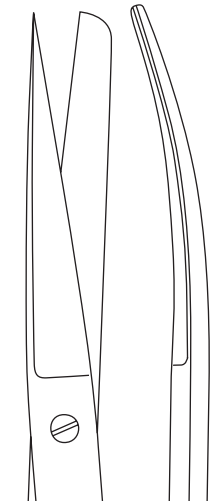


**12-002-11**  
**12-002-14**  
**12-002-16**  
**12-002-18**



**STANDARD Fig. 2**

<b>12-002-11</b>	11,0 cm, 4 3/8"
<b>12-002-14</b>	14,0 cm, 5 1/2"
<b>12-002-16</b>	16,0 cm, 6 1/4"
<b>12-002-18</b>	18,0 cm, 7"

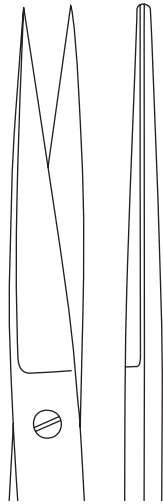


**12-003-14**  
**12-003-16**  
**12-003-18**



**STANDARD Fig. 2**

<b>12-003-14</b>	14,0 cm, 5 1/2"
<b>12-003-16</b>	16,0 cm, 6 1/4"
<b>12-003-18</b>	18,0 cm, 7"



**12-004-14**  
**12-004-16**  
**12-004-18**



**STANDARD Fig. 3**

<b>12-004-14</b>	14,0 cm, 5 ½"
<b>12-004-16</b>	16,0 cm, 6 ¼"
<b>12-004-18</b>	18,0 cm, 7"

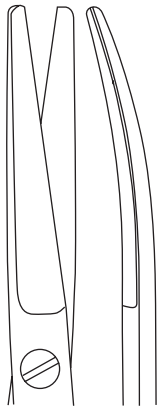


**12-005-14**  
**12-005-16**  
**12-005-18**



**STANDARD Fig. 3**

<b>12-005-14</b>	14,0 cm, 5 ½"
<b>12-005-16</b>	16,0 cm, 6 ¼"
<b>12-005-18</b>	18,0 cm, 7"



**12-107-15**



**MIXTER**

<b>12-107-15</b>	15,0 cm, 6"
------------------	-------------



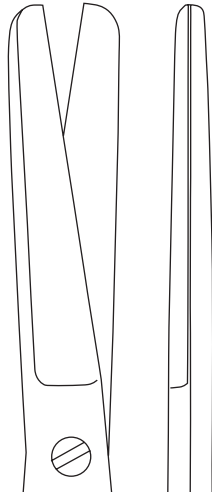
**12-141-20**



**WALDMANN**

<b>12-141-20</b>	20,0 cm, 8"
------------------	-------------

Damm Schere (Episiotomie)  
Perineum scissors (Episiotomy)  
Tijeras para perineo (episiotomia)  
Forbici per perineo (episiotomia)



**12-120-20**  
**12-120-23**



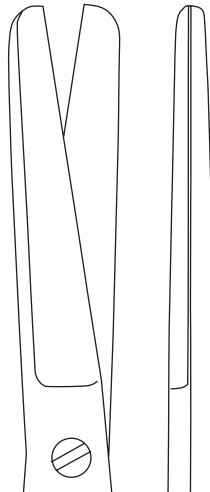
**12-121-20**  
**12-121-23**



**SIMS**

**12-120-20 - 12-121-20** 20,0 cm, 8"

**12-120-23 - 12-121-23** 23,0 cm, 9"



**12-120-20 W**



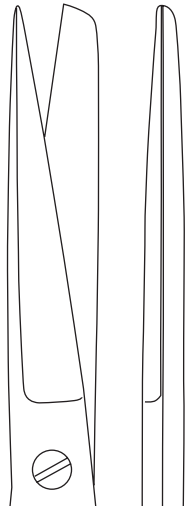
**12-121-20 W**  
**12-121-23 W**



**SIMS**

**12-120-20 W - 12-121-20 W** 20,0 cm, 8"

**12-121-23 W** 23,0 cm, 9"



**12-122-20**  
**12-122-23**



**12-123-20**  
**12-123-23**



**SIMS**

**12-122-20 - 12-123-20** 20,0 cm, 8"  
**12-122-23 - 12-123-23** 23,0 cm, 9"



**12-124-20**  
**12-124-23**

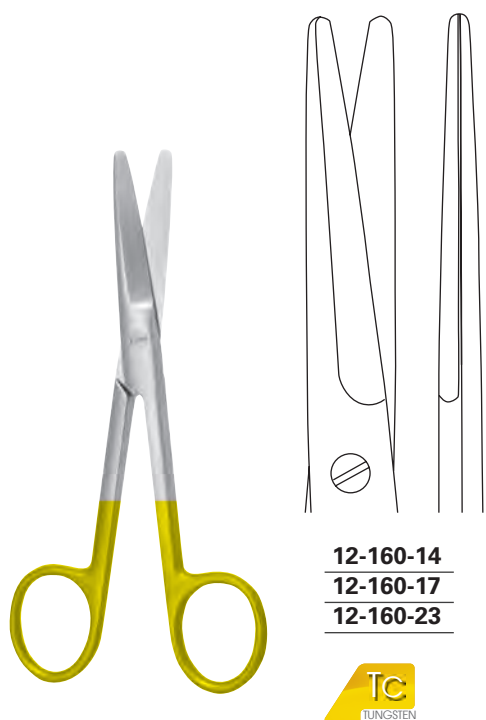


**12-125-20**  
**12-125-23**



**SIMS**

**12-124-20 - 12-125-20** 20,0 cm, 8"  
**12-124-23 - 12-125-23** 23,0 cm, 9"

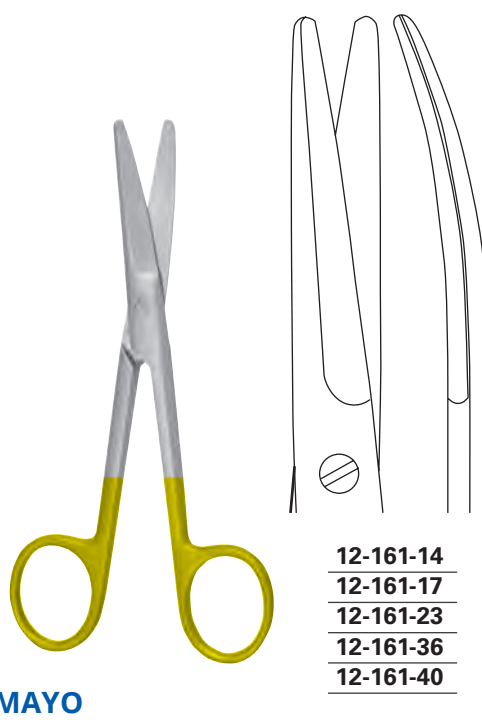


**12-160-14**  
**12-160-17**  
**12-160-23**



### MAYO

<b>12-160-14</b>	14,0 cm, 5 1/2 "
<b>12-160-17</b>	17,0 cm, 6 3/4 "
<b>12-160-23</b>	23,0 cm, 9 "

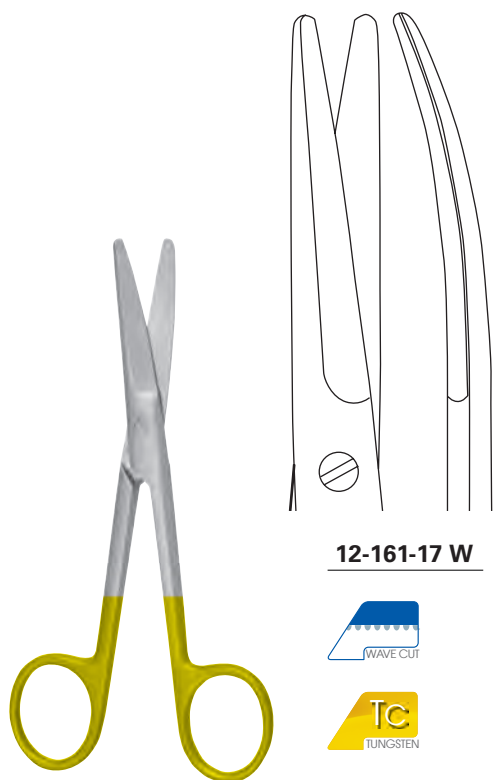


**12-161-14**  
**12-161-17**  
**12-161-23**  
**12-161-36**  
**12-161-40**



### MAYO

<b>12-161-14</b>	14,0 cm, 5 1/2 "
<b>12-161-17</b>	17,0 cm, 6 3/4 "
<b>12-161-23</b>	23,0 cm, 9 "
<b>12-161-36</b>	36,0 cm, 14 1/4 "
<b>12-161-40</b>	40,0 cm, 16 "

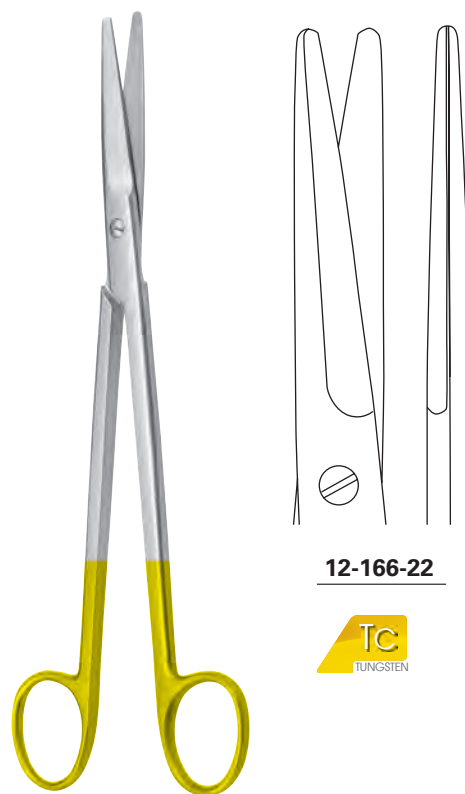


**12-161-17 W**



### MAYO

<b>12-161-17 W</b>	17,0 cm, 6 3/4 "
--------------------	------------------

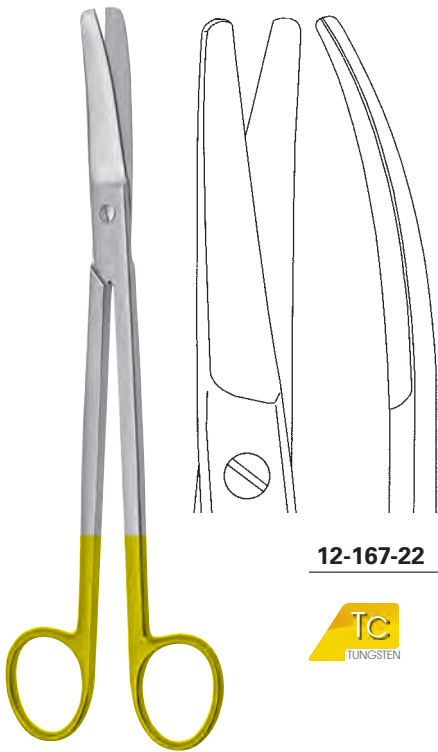


**12-166-22**

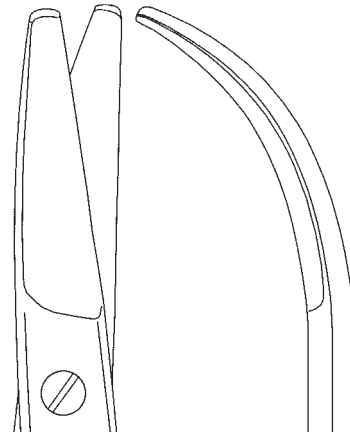


### MAYO-HARRINGTON

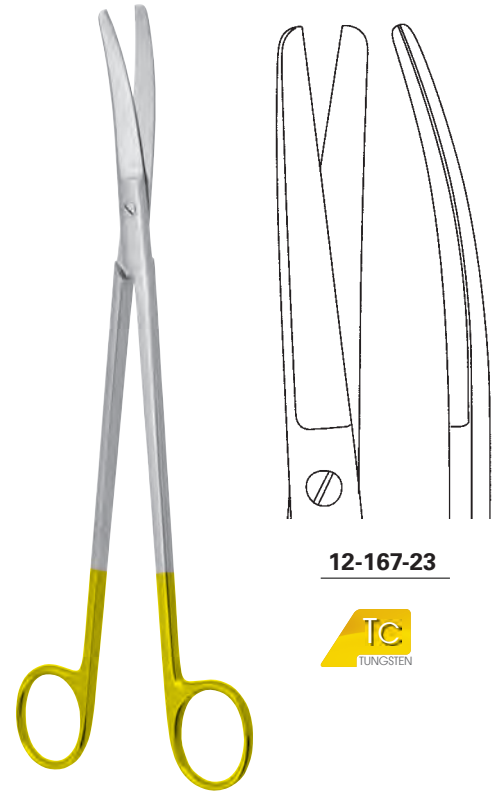
<b>12-166-22</b>	22,0 cm, 8 3/4 "
------------------	------------------



**12-167-22**



**12-169-23**



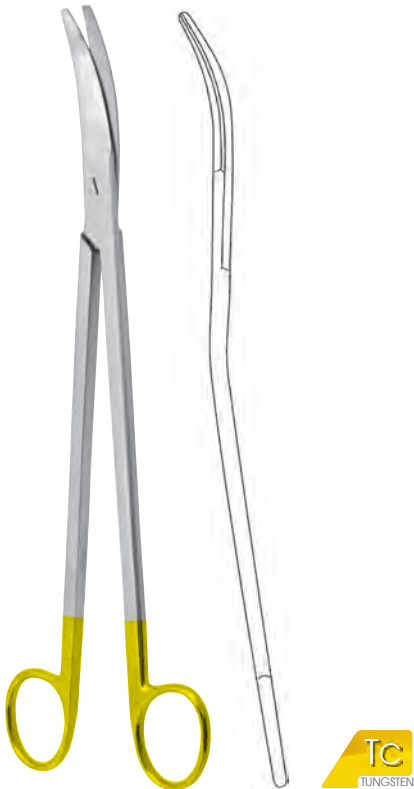
**12-167-23**



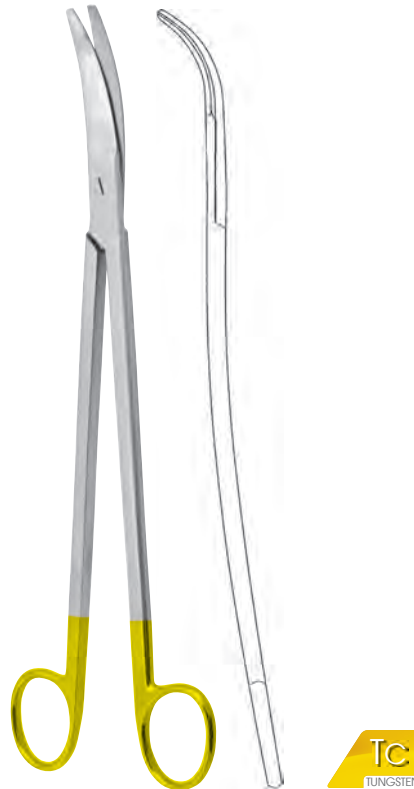
**12-167-22** 22,0 cm, 8 3/4"  
**12-169-23** 23,0 cm, 9"

**WERTHEIM**

**12-167-23** 23,0 cm, 9"

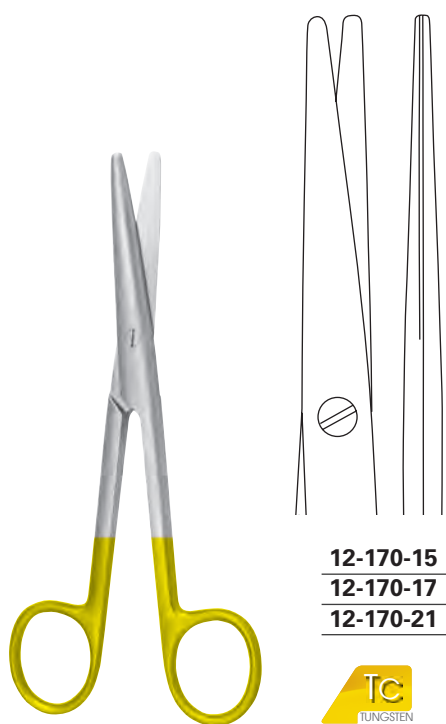


**12-173-25** 25,0 cm, 9 3/4"



**12-175-25** 25,0 cm, 9 3/4"



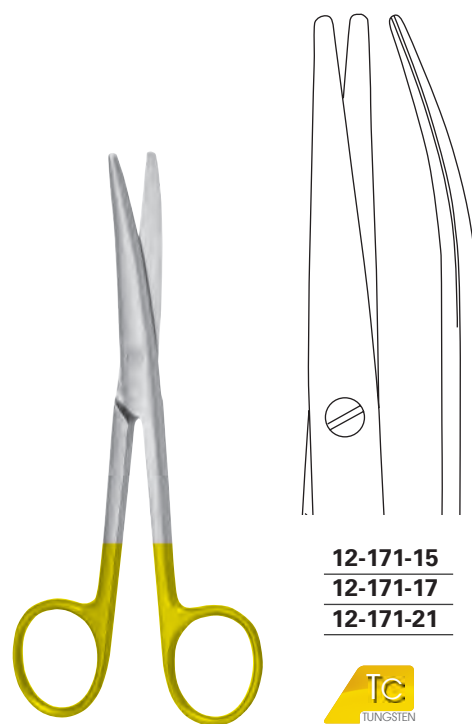


**12-170-15**  
**12-170-17**  
**12-170-21**



### MAYO-STILLE

<b>12-170-15</b>	15,0 cm, 6"
<b>12-170-17</b>	17,0 cm, 6 3/4"
<b>12-170-21</b>	21,0 cm, 8 1/4"

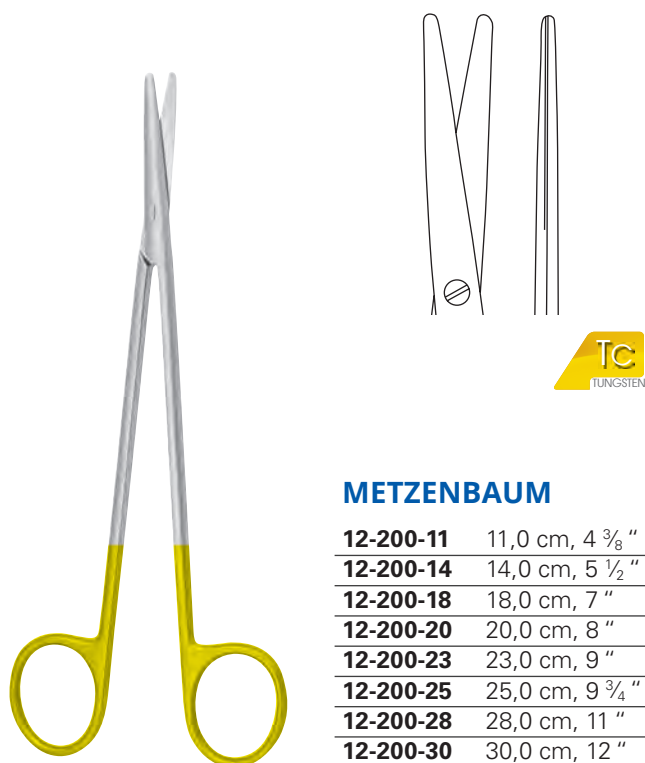


**12-171-15**  
**12-171-17**  
**12-171-21**



### MAYO-STILLE

<b>12-171-15</b>	15,0 cm, 6"
<b>12-171-17</b>	17,0 cm, 6 3/4"
<b>12-171-21</b>	21,0 cm, 8 1/4"



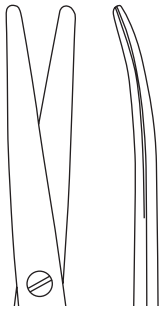
### METZENBAUM

<b>12-200-11</b>	11,0 cm, 4 3/8"
<b>12-200-14</b>	14,0 cm, 5 1/2"
<b>12-200-18</b>	18,0 cm, 7"
<b>12-200-20</b>	20,0 cm, 8"
<b>12-200-23</b>	23,0 cm, 9"
<b>12-200-25</b>	25,0 cm, 9 3/4"
<b>12-200-28</b>	28,0 cm, 11"
<b>12-200-30</b>	30,0 cm, 12"



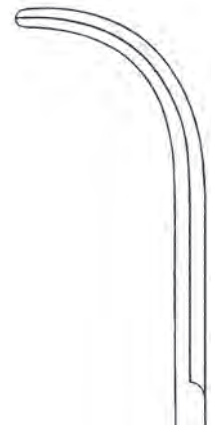
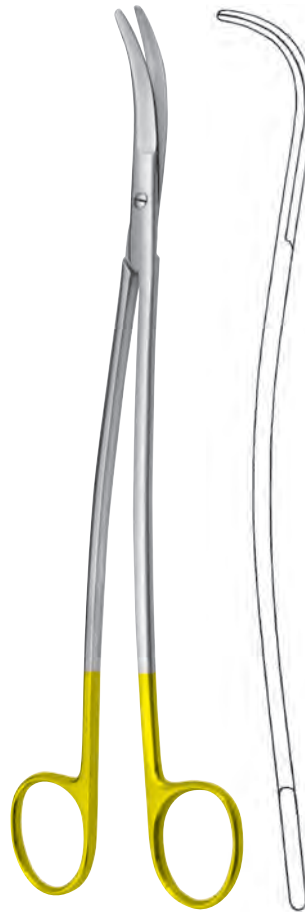
### METZENBAUM

<b>12-201-11</b>	11,0 cm, 4 3/8"
<b>12-201-14</b>	14,0 cm, 5 1/2"
<b>12-201-18</b>	18,0 cm, 7"
<b>12-201-20</b>	20,0 cm, 8"
<b>12-201-23</b>	23,0 cm, 9"
<b>12-201-25</b>	25,0 cm, 9 3/4"
<b>12-201-28</b>	28,0 cm, 11"
<b>12-201-30</b>	30,0 cm, 12"
<b>12-201-36</b>	36,0 cm, 14 1/4"
<b>12-201-40</b>	40,0 cm, 16"



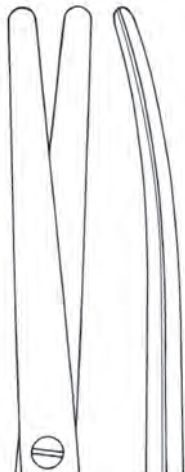
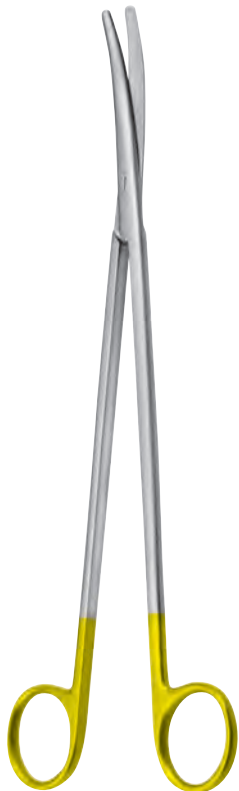
**METZENBAUM**

- 12-201-11 W** 11,0 cm, 4 3/8 "
- 12-201-14 W** 14,0 cm, 5 1/2 "
- 12-201-18 W** 18,0 cm, 7 "
- 12-201-20 W** 20,0 cm, 8 "
- 12-201-23 W** 23,0 cm, 9 "



**METZENBAUM-S**

- 12-209-20** 20,0 cm, 8 "
- 12-209-23** 23,0 cm, 9 "
- 12-209-25** 25,0 cm, 9 3/4 "
- 12-209-28** 28,0 cm, 11 "

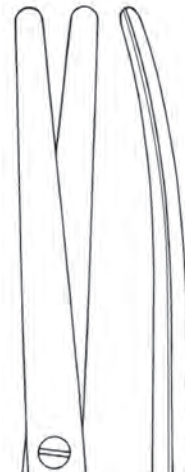
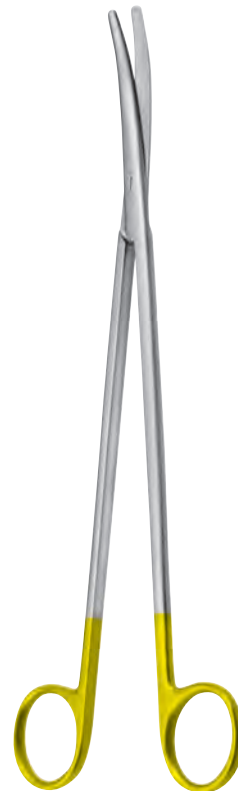


**12-207-23**



**METZENBAUM**

**12-207-23** 23,0 cm, 9 "

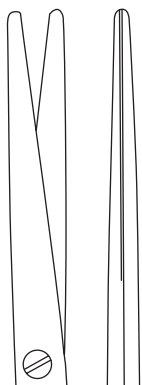
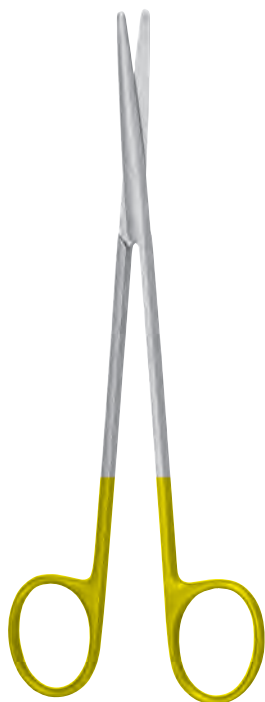


**12-207-23 W**



**METZENBAUM**

**12-207-23 W** 23,0 cm, 9 "



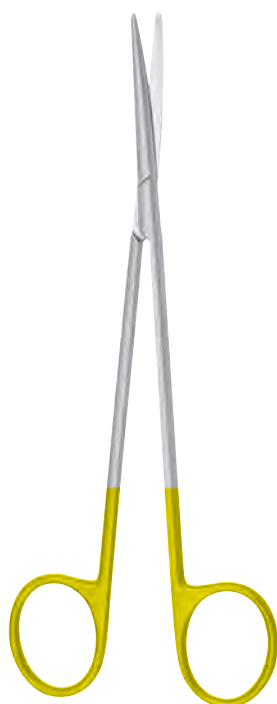
### METZENBAUM-FINO

<b>12-210-14</b>	14,0 cm, 5 1/2 "
<b>12-210-18</b>	18,0 cm, 7 "
<b>12-210-20</b>	20,0 cm, 8 "
<b>12-210-23</b>	23,0 cm, 9 "
<b>12-210-25</b>	25,0 cm, 9 3/4 "
<b>12-210-28</b>	28,0 cm, 11 "



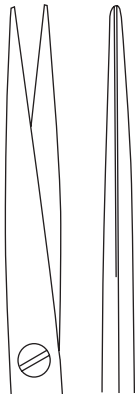
### METZENBAUM-FINO

<b>12-211-14</b>	14,0 cm, 5 1/2 "
<b>12-211-18</b>	18,0 cm, 7 "
<b>12-211-20</b>	20,0 cm, 8 "
<b>12-211-23</b>	23,0 cm, 9 "
<b>12-211-25</b>	25,0 cm, 9 3/4 "
<b>12-211-28</b>	28,0 cm, 11 "



### METZENBAUM-FINO

<b>12-211-14 W</b>	14,0 cm, 5 1/2 "
<b>12-211-18 W</b>	18,0 cm, 7 "
<b>12-211-20 W</b>	20,0 cm, 8 "
<b>12-211-23 W</b>	23,0 cm, 9 "
<b>12-211-25 W</b>	25,0 cm, 9 3/4 "
<b>12-211-28 W</b>	28,0 cm, 11 "



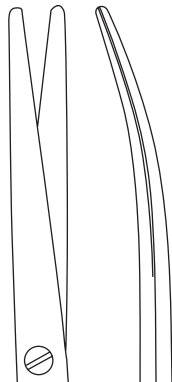
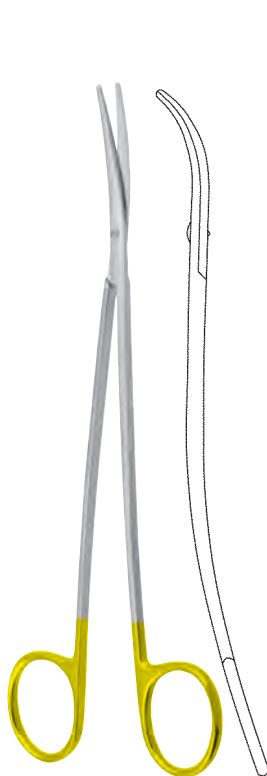
**METZENBAUM-FINO**

<b>12-214-14</b>	14,0 cm, 5 1/2 "
<b>12-214-18</b>	18,0 cm, 7 "
<b>12-214-20</b>	20,0 cm, 8 "
<b>12-214-23</b>	23,0 cm, 9 "



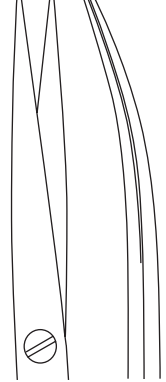
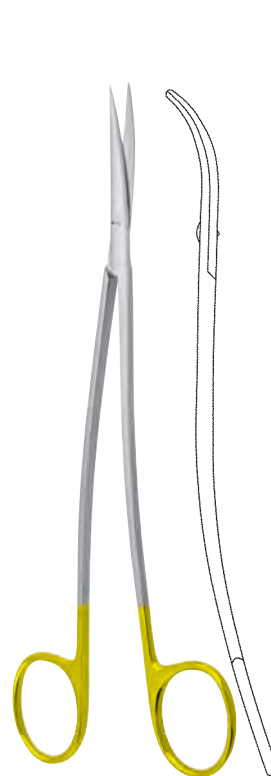
**METZENBAUM-FINO**

<b>12-215-11</b>	11,0 cm, 4 3/8 "
<b>12-215-14</b>	14,0 cm, 5 1/2 "
<b>12-215-18</b>	18,0 cm, 7 "
<b>12-215-20</b>	20,0 cm, 8 "
<b>12-215-23</b>	23,0 cm, 9 "



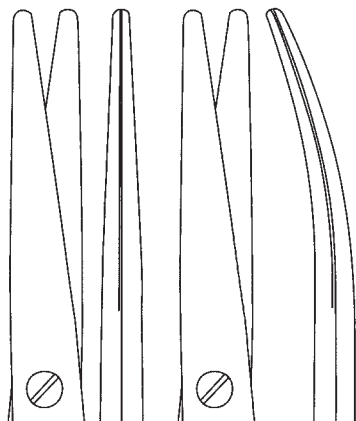
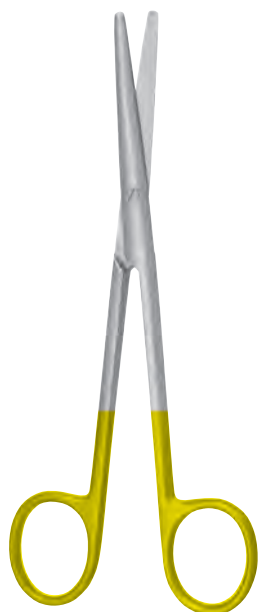
**METZENBAUM-FINO-S**

<b>12-221-18</b>	18,0 cm, 7 "
<b>12-221-20</b>	20,0 cm, 8 "
<b>12-221-23</b>	23,0 cm, 9 "



**METZENBAUM-FINO-S**

<b>12-225-18</b>	18,0 cm, 7 "
<b>12-225-20</b>	20,0 cm, 8 "
<b>12-225-23</b>	23,0 cm, 9 "



**12-230-16**  
**12-230-21**



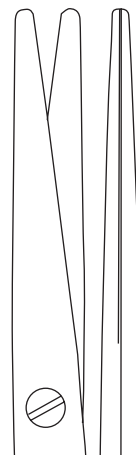
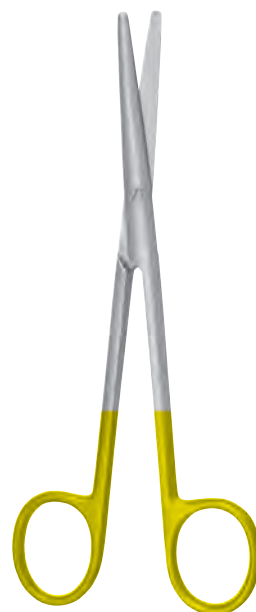
**12-231-16**  
**12-231-21**



### MAYO-LEXER

**12-230-16 - 12-231-16** 16,0 cm, 6 ¼"

**12-230-21 - 12-231-21** 21,0 cm, 8 ¼"

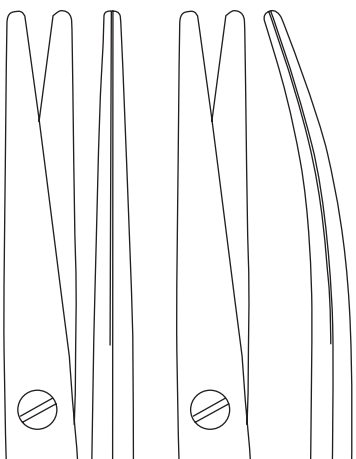
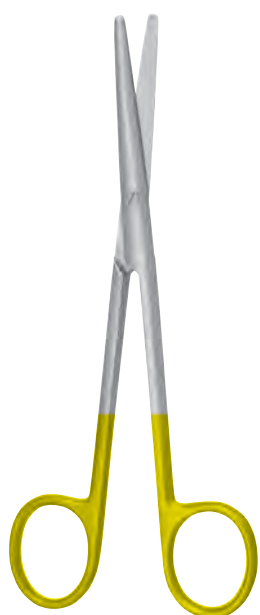


**12-233-16 W**



### LEXER

**12-233-16 W** 16,0 cm, 6 ¼"



**12-232-16**

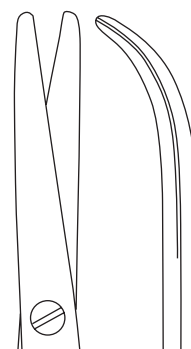


**12-233-16**



### LEXER

**12-232-16 - 12-233-16** 16,0 cm, 6 ¼"



**12-241-20**

**12-241-23**

**12-241-28**



### THOREK

**12-241-20** 20,0 cm, 8"

**12-241-23** 23,0 cm, 9"

**12-241-28** 28,0 cm, 11"



**12-243-14**



**JOSEPH**

**12-243-14** 14,5 cm, 5 <sup>3</sup>/<sub>4</sub> "



**12-245-12**  
**12-245-15**



**KILNER**

**12-245-12** 12,0 cm, 4 <sup>3</sup>/<sub>4</sub> "  
**12-245-15** 15,0 cm, 5 "

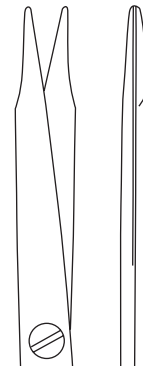
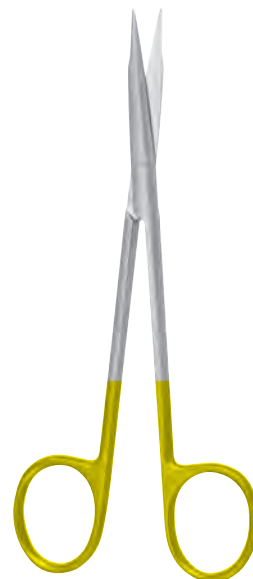


**12-247-13**  
**12-247-15**



**JAMESON**

**12-247-13** 13,0 cm, 5 <sup>1</sup>/<sub>8</sub> "  
**12-247-15** 15,0 cm, 5 "



**12-248-15**



**REYNOLDS**

**12-248-15** 15,0 cm, 5 "



**12-249-15**  
**12-249-18**



**REYNOLDS**

**12-249-15** 15,0 cm, 5 "  
**12-249-18** 18,0 cm, 7 "

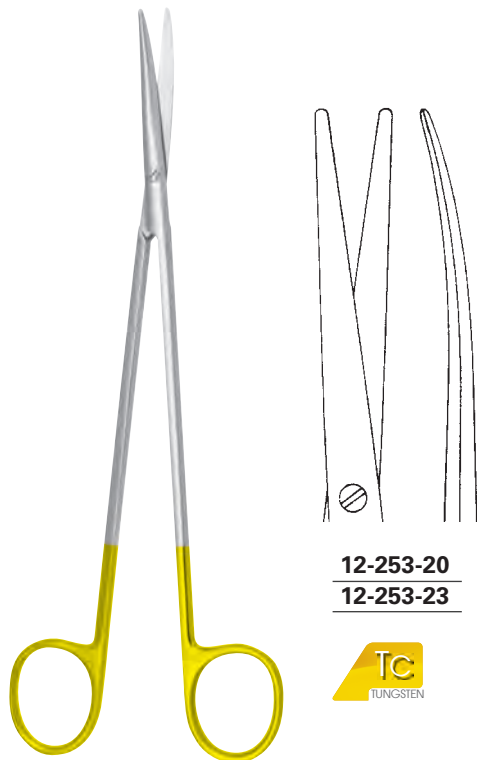


**12-253-14**



**METZENBAUM-LAHEY**

**12-253-14** 14,0 cm, 5 1/2 "



**12-253-20**  
**12-253-23**



**METZENBAUM-LAHEY**

**12-253-20** 20,0 cm, 8 "  
**12-253-23** 23,0 cm, 9 "



**12-253-17**



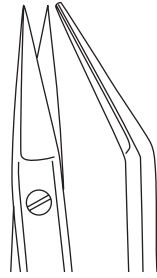
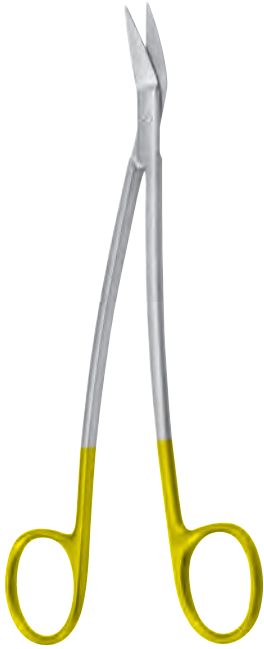
**TOENNIS-ADSON**

**12-253-17** 17,5 cm, 7 "



**TOENNIS-ADSON**

**12-253-17W** 17,5 cm, 7 "



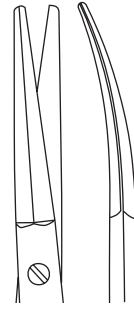
**12-305-17**



Tonsillenschere  
 Tonsil scissors  
 Tijera para amígdalas  
 Forbici per tonsille

**DEAN**

**12-305-17** 17,0 cm, 6 3/4"



**12-319-13**



Nasenschere  
 Nasal scissors  
 Tijera nasales  
 Forbici nasali

**FOMON**

**12-319-13** 13,0 cm, 5 1/8"



**12-329-13**



Nasenschere  
 Nasal scissors  
 Tijera nasales  
 Forbici nasali

**FOMON**

**12-329-13** 13,0 cm, 5 1/8"



**12-331-16**

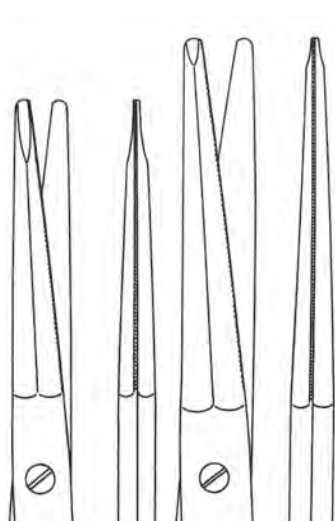


Nasenschere  
 Nasal scissors  
 Tijera nasales  
 Forbici nasali

**COTTLE**

**12-331-16** 16,0 cm, 6 1/4"





**12-360-20**

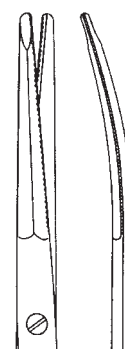
**12-360-23**



**GORNEY**

**12-360-20** 20,0 cm, 8 "

**12-360-23** 23,0 cm, 9 "

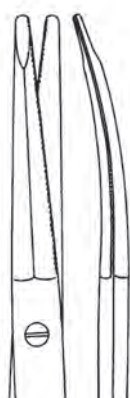


**12-363-14**



**GREGORY**

**12-363-14** 14,0 cm, 5 1/2 "



**12-365-15**

**12-365-18**



**KAYE**

**12-365-15** 14,5 cm, 5 3/4 "

**12-365-18** 18,0 cm, 7 "

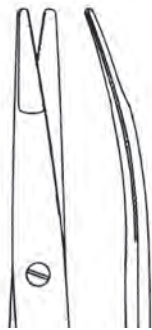
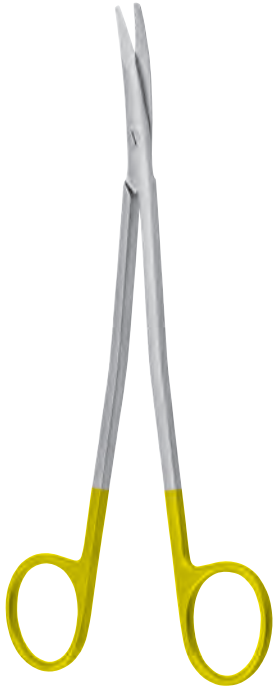


**12-367-18**

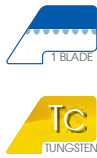


**STELLA**

**12-367-18** 18,0 cm, 7 "

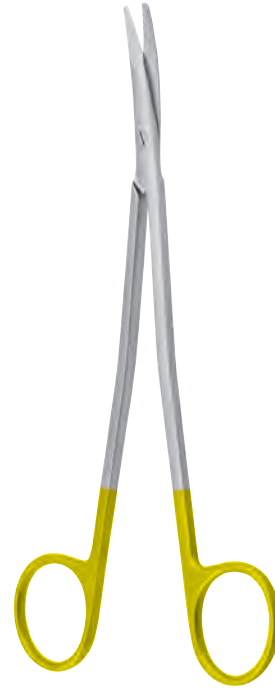


**12-369-18**



**GORNEY-FREEMAN**

**12-369-18** 18,0 cm, 7"

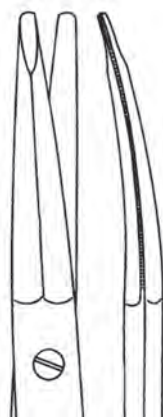


**12-370-23**



**GORNEY-FREEMAN**

**12-370-23** 23,0 cm, 9"

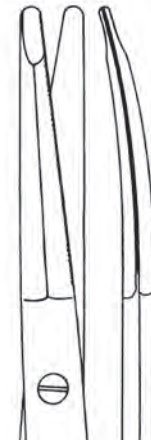


**12-371-18**



**FREEMAN-KAYE**

**12-371-18** 18,0 cm, 7"

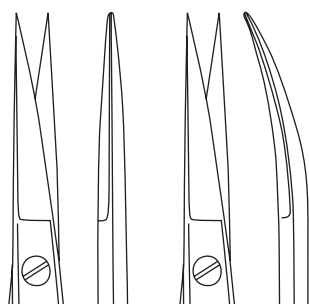
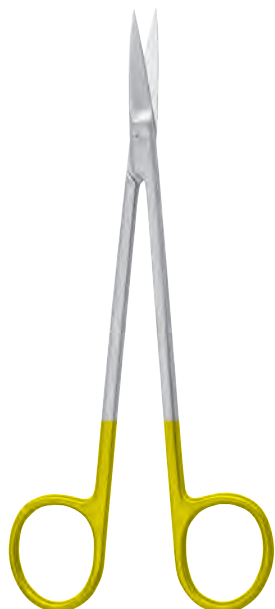


**12-371-23**



**FREEMAN-GORNEY**

**12-371-23** 23,0 cm, 9"



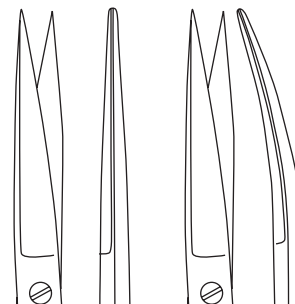
12-400-16

12-401-16



### KELLY

12-400-16 - 12-401-16 16,0 cm, 6 ¼ "



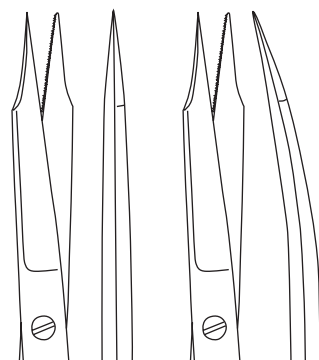
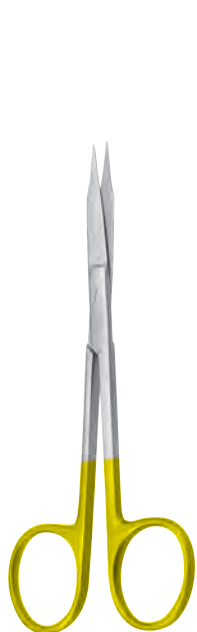
12-404-14

12-405-14



### JOSEPH

12-404-14 - 12-405-14 14,0 cm, 5 ½ "



12-416-13

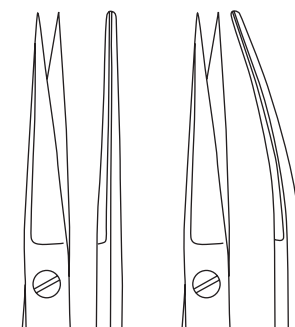
12-417-13



### GOLDMANN-FOX

12-416-13 - 12-417-13 13,0 cm, 5 ⅛ "

Zahnfleissscheren  
 Gum scissors  
 Tijeras para encias  
 Forbici per gengiva



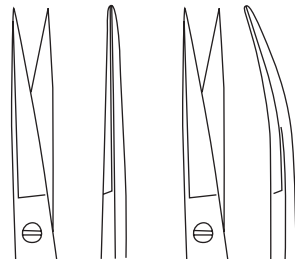
12-424-12

12-425-12



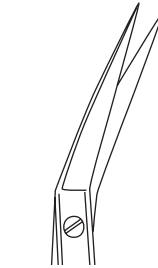
### WAGNER

12-424-12 - 12-425-12 12,0 cm, 4 ¾ "

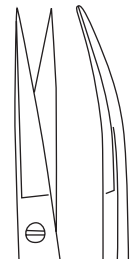


**12-436-11**

**12-437-11**



**12-438-11**



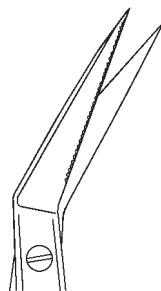
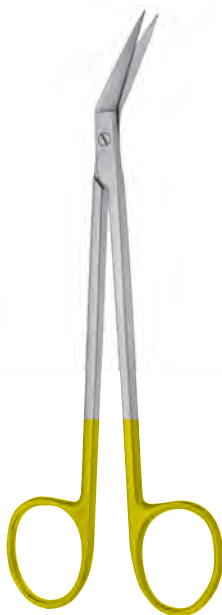
**12-437-11 W**



**IRIS**

**12-436-11 - 12-438-11** 11,5 cm, 4 1/2"

**12-437-11 W** 17,0 cm, 6 3/4"



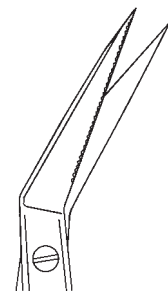
**12-519-16**



Zahnfleischschere  
 Gum scissors  
 Tijera para encías  
 Forbici per gengiva

**LOCKLIN**

**12-519-16** 16,0 cm, 6 1/4"



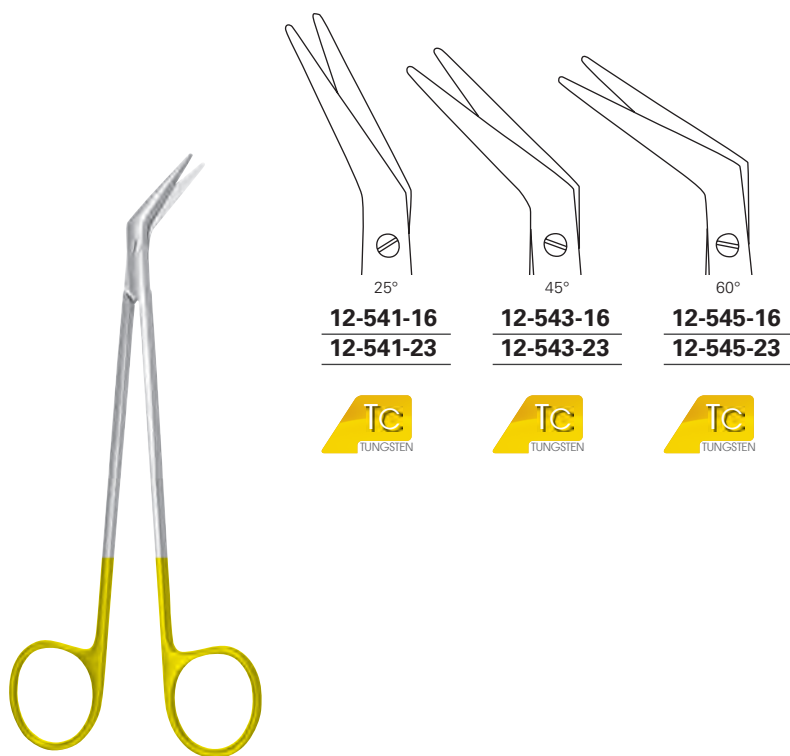
**12-521-16**



Zahnfleischschere  
 Gum scissors  
 Tijera para encías  
 Forbici per gengiva

**LOCKLIN-S**

**12-521-16** 16,0 cm, 6 1/4"



### DE BAKEY

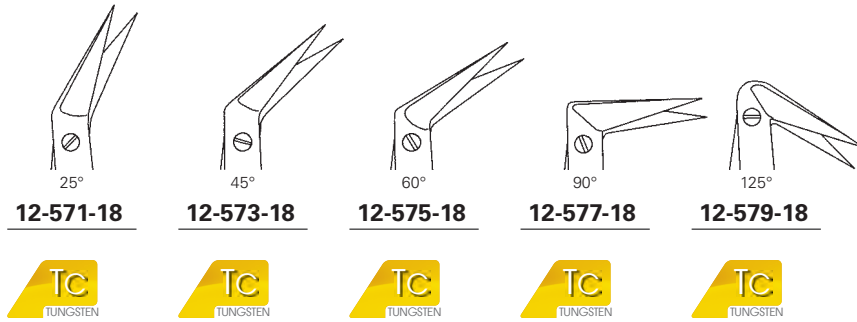
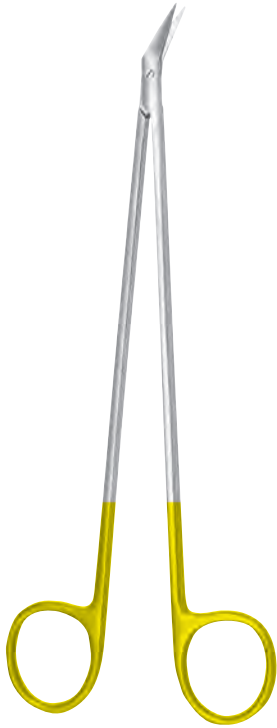
12-541-16 - 12-545-16 16,0 cm, 6 ¼ "

12-541-23 - 12-545-23 23,0 cm, 9 "



### POTTS-SMITH

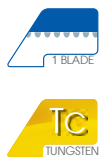
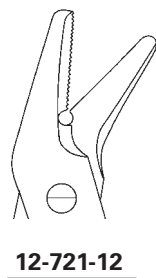
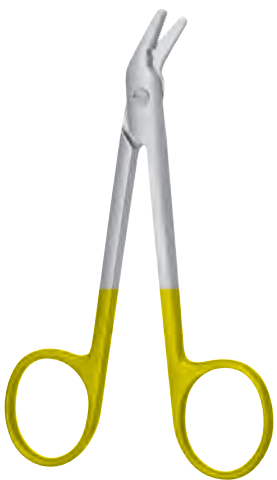
12-551-19 - 12-555-19 19,0 cm, 7 ½ "



Gefäßscheren  
 Vascular scissors  
 Tijeras vasculares  
 Forbici vascolari

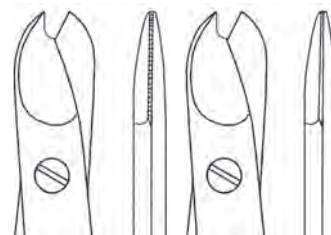
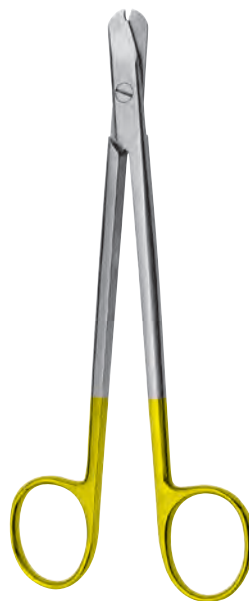
**HEGEMANN-DIETRICH**

**12-571-18 - 12-579-18** 18,0 cm, 7 "



**UNIVERSAL**

**12-721-12** 12,0 cm, 4 3/4 "

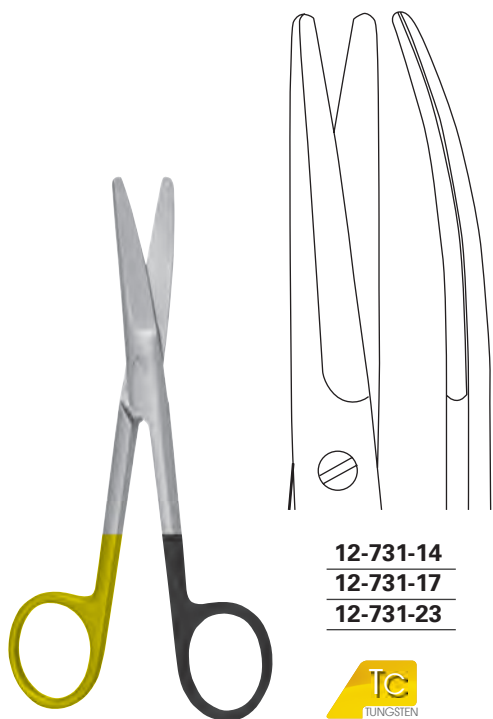


**12-722-16** **12-724-16**



**SMITH**

**12-722-16 - 12-724-16** 16,0 cm, 6 1/4 "

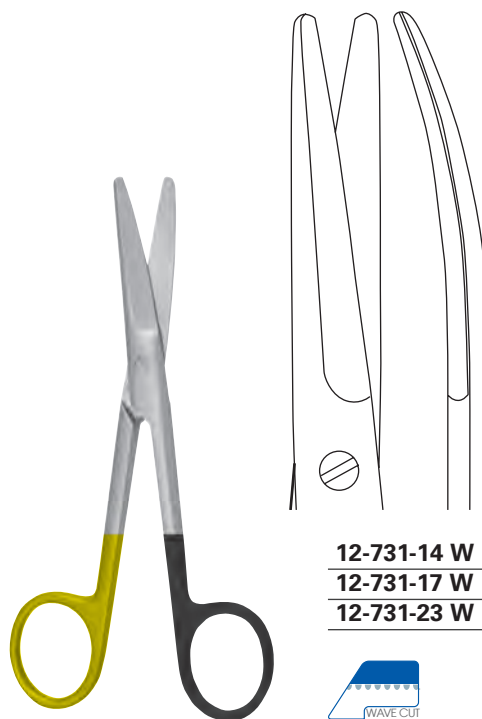


**12-731-14**  
**12-731-17**  
**12-731-23**



### MAYO

**12-731-14** 14,0 cm, 5 1/2 "  
**12-731-17** 17,0 cm, 6 3/4 "  
**12-731-23** 23,0 cm, 9 "



**12-731-14 W**  
**12-731-17 W**  
**12-731-23 W**



### MAYO

**12-731-14 W** 14,0 cm, 5 1/2 "  
**12-731-17 W** 17,0 cm, 6 3/4 "  
**12-731-23 W** 23,0 cm, 9 "

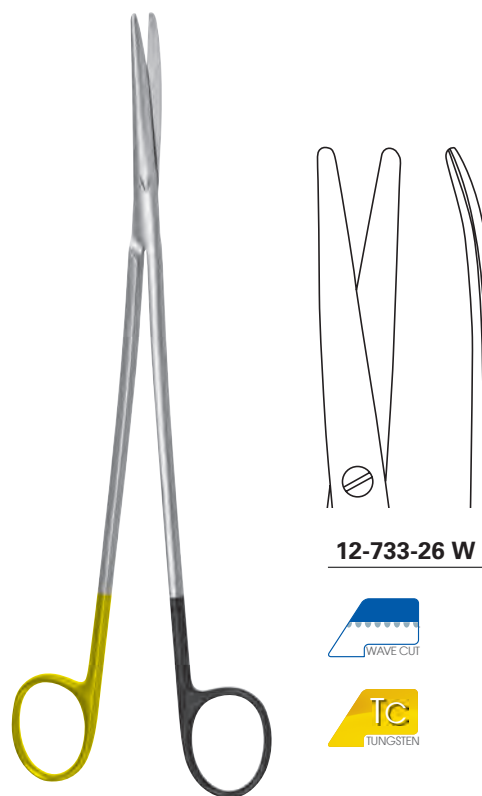


**12-733-14 W**  
**12-733-18 W**  
**12-733-20 W**  
**12-733-23 W**



### METZENBAUM

**12-733-14 W** 14,0 cm, 5 1/2 "  
**12-733-18 W** 18,0 cm, 7 "  
**12-733-20 W** 20,0 cm, 8 "  
**12-733-23 W** 23,0 cm, 9 "



**12-733-26 W**



### METZENBAUM

**12-733-26 W** 26,0 cm, 10 1/4 "







# 12

SUPERCUT TITAN-NITRIT Scheren

SUPERCUT TITANIUM-NITRITE scissors

Tijeras SUPERCUT NITRITO de TITANIO

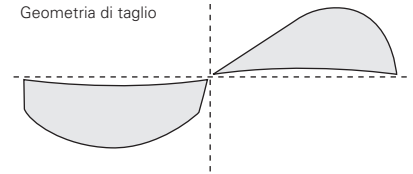
Forbici SUPERCUT NITRITO di TITANIO



Kennzeichnung: schwarzes Finish, goldene Schraube  
 Characteristic: black finish, golden screw  
 Característica: superficie negro, tornillo dorado  
 Caratteristica: finitura nero, vite dorata



Schneidegeometrie  
 Cutting geometry  
 Geometria del corte  
 Geometria di taglio



Bei SUPERCUT TITAN-NITRIT Scheren hat ein Blatt die Schneidegeometrie eines Messers, was einen mühelosen, messerartigen Schnitt ermöglicht.

**Beschichtungen aus TITAN-NITRIT:**

- Durch die elektro-physikalische Glättung wird die Gleitfähigkeit der Instrumente stark verbessert, was einen geringeren Abrieb und damit weniger Verschleiß zur Folge hat.
- Die außergewöhnliche Glätte führt zu einem leichten Gleiten der Scherenblätter auch bei höchster Beanspruchung.
- Dank der glatten Oberfläche wird die Reinigung der Scheren wesentlich erleichtert.
- Durch die Beschichtung erhöht sich die Oberflächenhärte um das 3-5 fache. Dies vervielfacht die Standzeit der Schneidekanten und macht die Instrumente äußerst kratzfest und schlagzäh.
- Die Beschichtung ist in hohem Maße inert, d.h. die molekulare Bindung ist chemisch sehr widerstandsfähig. Dadurch werden unerwünschte Reaktionen beim Eintauchen in Lösungen oder bei der Sterilisation vermieden.
- Auch beim intensiven Einsatz in sauren oder basischen Lösungen bleibt die hohe Glätte der Oberfläche erhalten.
- Die inerte Beschichtung ist auch bei hohen Temperaturen stabil.

**Eigenschaften von TIN - Beschichtungen:**

- 3-5 fache Härte gegenüber gehärtetem Stahl
- glatte, dichte, keramische Materialstruktur
- edle Oberflächenoptik, weniger Reflexion
- antikorrosive, leicht zu reinigende Oberfläche
- wesentlich beständiger gegen Lösungsmittel und aggressive Flüssigkeiten als unbeschichteter Stahl
- kratzbeständig
- temperaturbeständig
- hohe Haftfestigkeit
- geringe Reibung





Scissors with SUPERCUT TITANIUM-NITRITE have one razor blade which allows an easy and clean cut through tissue.

**TITANIUM NITRITE coatings:**

- The glide quality of the instruments is considerably improved by electrophysical smoothing, resulting in less abrasion and reduced wear.
- The exceptional smoothness means that the scissor blades slide easily, even under maximum stress.
- The smooth surface makes the scissors much easier to clean.
- The coating makes the surface three to five times harder. This multiplies the lifetime of the cutting edges and makes the instruments extremely resistant to scratches and impacts.
- The coating is largely inert, which means that the molecular binding is very chemically resistant. This prevents undesirable reactions when the instruments are immersed in solutions or sterilised.
- Even under intensive use of acid or alkaline solutions, the high level of surface smoothness is retained.
- The inert coating is also stable at high temperatures.

**Characteristics of TIN - coatings:**

- 3-5 times harder than hardened steel
- smooth, impervious, ceramic material structure
- high-grade surface finish, reduced reflection
- anti-corrosive, easy to clean surface
- far more resistant to solvents and aggressive fluids than uncoated steel
- scratch-resistant
- temperature-resistant
- high level of adherence
- low friction



Las tijeras SUPERCUT con revestimiento de NITRITO DE TITANIO tienen una de las hojas con la geometría de corte de un bisturí, lo que permite realizar la incisión sin esfuerzo, como si se tratara realmente de un bisturí.

**Revestimiento de NITRITO DE TITANIO:**

- El alisado electrofísico mejora considerablemente la capacidad de deslizamiento del instrumental, por lo que se produce menor abrasión y, en consecuencia, un desgaste más reducido.
- Gracias a su extraordinaria suavidad, las hojas de las tijeras se deslizan fácilmente, incluso en las condiciones más difíciles.
- Además, esta superficie lisa facilita también las operaciones de limpieza.
- Por otro lado, el revestimiento aumenta de tres a cinco veces la dureza de la superficie, lo que también alarga la duración de los cantos de corte y protege enormemente los instrumentos frente al rayado o a los golpes.
- El revestimiento es prácticamente inerte, es decir, el enlace molecular es químicamente resistente, lo que excluye la posibilidad de que se produzcan reacciones no deseadas al introducir las tijeras en ciertas disoluciones o esterilizarlas.
- La suavidad y lisura de la superficie se mantiene incluso con un uso intensivo en disoluciones ácidas o básicas.
- El revestimiento inerte también es estable a altas temperaturas.

**Propiedades de los revestimientos de nitrato de titanio:**

- de tres a cinco más de dureza que el acero endurecido
- estructura del material cerámico compacta y lisa
- aspecto exterior impecable, con menos reflexión
- superficie anticorrosiva y fácil de limpiar
- mucho más resistente a disolventes y líquidos agresivos que el acero no revestido
- resistente al rayado
- resistente a los cambios térmicos
- alta fuerza adhesiva
- poca fricción



Le forbici SUPERCUT in NITRITO di TITANIO hanno una lama con la geometria di taglio di un coltello che consente di eseguire tagli agevoli, puliti e precisi come un coltello.

**Rivestimento in NITRITO di TITANIO:**

- La capacità allo scorrimento degli strumenti è notevolmente migliorata grazie alla levigatura elettro-fisica: ciò significa una ridotta abrasione e quindi una minore usura.
- L'eccezionale levigatura consente un agevole scorrimento delle lame della forbice anche nelle sollecitazioni più estreme.
- La pulizia delle forbici è notevolmente facilitata grazie alla superficie liscia.
- Il rivestimento aumenta la durezza della superficie di 3-5 volte. Ciò moltiplica la durata utile degli spigoli taglienti e rende gli strumenti estremamente resistenti ai graffi e agli urti.
- Il rivestimento è altamente inerte, ciò significa che il legame molecolare è chimicamente molto resistente. Questo evita reazioni indesiderate durante l'immersione in soluzioni o nel corso dell'operazione di sterilizzazione.
- La grande levigatezza delle superfici non viene intaccata neanche con un uso intenso in soluzioni acide e basiche.
- Il rivestimento inerte è stabile anche ad alte temperature.

**Proprietà di rivestimenti in TIN:**

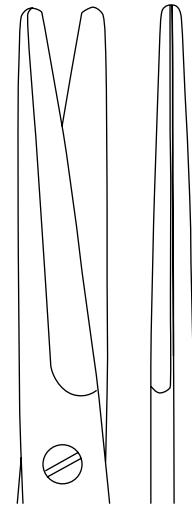
- durezza 3-5 volte superiore rispetto all'acciaio temprato
- struttura del materiale levigata, compatta e ceramizzata
- superficie di ottica pregiata, meno riflettente
- superficie anticorrosione, facile da pulire
- notevolmente più resistente dell'acciaio non rivestito nei confronti di solventi e liquidi aggressivi
- antigraffio
- termostabile
- elevata adesività
- basso attrito





**12-121-20 SCT**  
**12-121-23 SCT**

Uterusscheren  
 Uterine scissors  
 Tijeras uterinas  
 Forbici da uteroa



**12-160-14 SCT**  
**12-160-17 SCT**  
**12-160-23 SCT**

Chirurgische Scheren  
 Surgical scissors  
 Tijeras para cirugia  
 Forbici per chirurgia

**SIMS**

- 12-121-20 SCT** 20,0 cm, 8"
- 12-121-23 SCT** 23,0 cm, 9"



**MAYO**

- 12-160-14 SCT** 14,0 cm, 5 1/2"
- 12-160-17 SCT** 17,0 cm, 6 3/4"
- 12-160-23 SCT** 23,0 cm, 9"



**12-161-14 SCT**  
**12-161-17 SCT**  
**12-161-23 SCT**

Chirurgische Scheren  
 Surgical scissors  
 Tijeras para cirugia  
 Forbici per chirurgia



**12-167-22 SCT**

Chirurgische Schere  
 Surgical scissors  
 Tijera para cirugia  
 Forbici per chirurgia

**MAYO**

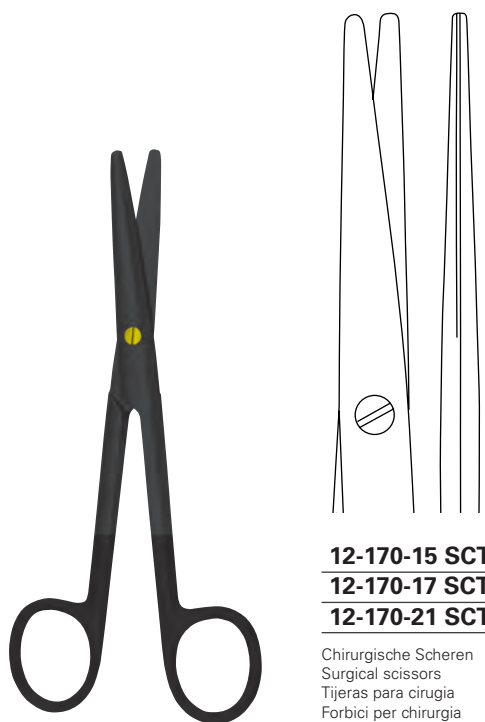
- 12-161-14 SCT** 14,0 cm, 5 1/2"
- 12-161-17 SCT** 17,0 cm, 6 3/4"
- 12-161-23 SCT** 23,0 cm, 9"



**MAYO-HARRINGTON**

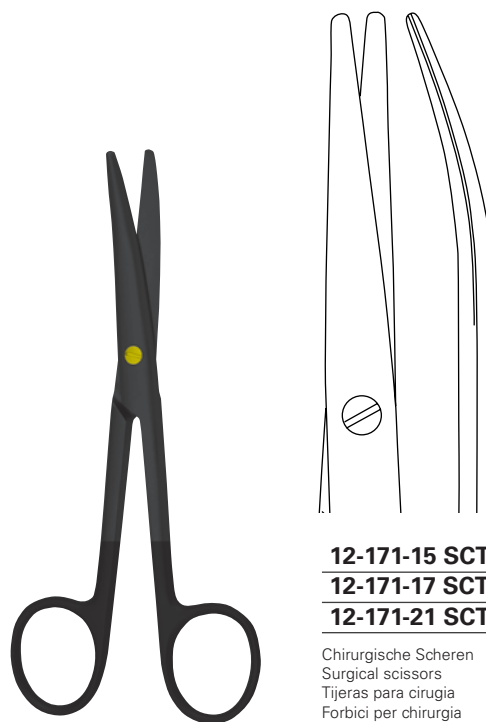
- 12-167-22 SCT** 22,0 cm, 8 3/4"





**12-170-15 SCT**  
**12-170-17 SCT**  
**12-170-21 SCT**

Chirurgische Scheren  
 Surgical scissors  
 Tijeras para cirugía  
 Forbici per chirurgia



**12-171-15 SCT**  
**12-171-17 SCT**  
**12-171-21 SCT**

Chirurgische Scheren  
 Surgical scissors  
 Tijeras para cirugía  
 Forbici per chirurgia

## MAYO-STILLE

**12-170-15 SCT** 15,0 cm, 6 "  
**12-170-17 SCT** 17,0 cm, 6 <sup>3</sup>/<sub>4</sub> "  
**12-170-21 SCT** 21,0 cm, 8 <sup>1</sup>/<sub>4</sub> "



## MAYO-STILLE

**12-171-15 SCT** 15,0 cm, 6 "  
**12-171-17 SCT** 17,0 cm, 6 <sup>3</sup>/<sub>4</sub> "  
**12-171-21 SCT** 21,0 cm, 8 <sup>1</sup>/<sub>4</sub> "



Präparierscheren  
 Dissecting scissors  
 Tijeras des disección  
 Forbici per dissezione



## METZENBAUM

**12-200-11 SCT** 11,0 cm, 4 <sup>3</sup>/<sub>8</sub> "  
**12-200-14 SCT** 14,0 cm, 5 <sup>1</sup>/<sub>2</sub> "  
**12-200-18 SCT** 18,0 cm, 7 "  
**12-200-20 SCT** 20,0 cm, 8 "  
**12-200-23 SCT** 23,0 cm, 9 "  
**12-200-25 SCT** 25,0 cm, 9 <sup>3</sup>/<sub>4</sub> "  
**12-200-28 SCT** 28,0 cm, 11 "  
**12-200-30 SCT** 30,0 cm, 12 "



Präparierscheren  
 Dissecting scissors  
 Tijeras des disección  
 Forbici per dissezione



## METZENBAUM

**12-201-11 SCT** 11,0 cm, 4 <sup>3</sup>/<sub>8</sub> "  
**12-201-14 SCT** 14,0 cm, 5 <sup>1</sup>/<sub>2</sub> "  
**12-201-18 SCT** 18,0 cm, 7 "  
**12-201-20 SCT** 20,0 cm, 8 "  
**12-201-23 SCT** 23,0 cm, 9 "  
**12-201-25 SCT** 25,0 cm, 9 <sup>3</sup>/<sub>4</sub> "  
**12-201-28 SCT** 28,0 cm, 11 "  
**12-201-30 SCT** 30,0 cm, 12 "



Präparierscheren  
 Dissecting scissors  
 Tijeras des disección  
 Forbici per dissezione



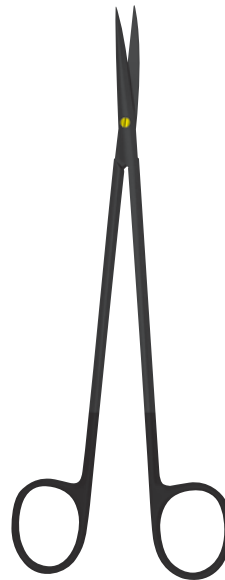
**METZENBAUM-FINO**

- 12-211-11 SCT** 11,0 cm, 4 <sup>3</sup>/<sub>8</sub> "
- 12-211-14 SCT** 14,0 cm, 5 <sup>1</sup>/<sub>2</sub> "
- 12-211-18 SCT** 18,0 cm, 7 "
- 12-211-20 SCT** 20,0 cm, 8 "
- 12-211-23 SCT** 23,0 cm, 9 "
- 12-211-25 SCT** 25,0 cm, 9 <sup>3</sup>/<sub>4</sub> "
- 12-211-28 SCT** 28,0 cm, 11 "



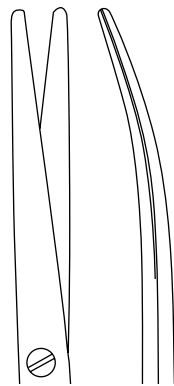
**12-215-14 SCT**

Präparierschere  
 Dissecting scissors  
 Tijera des disección  
 Forbici per dissezione



**METZENBAUM-FINO**

- 12-215-14 SCT** 14,0 cm, 5 <sup>1</sup>/<sub>2</sub> "

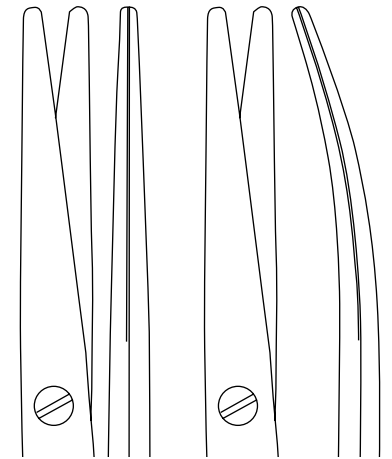
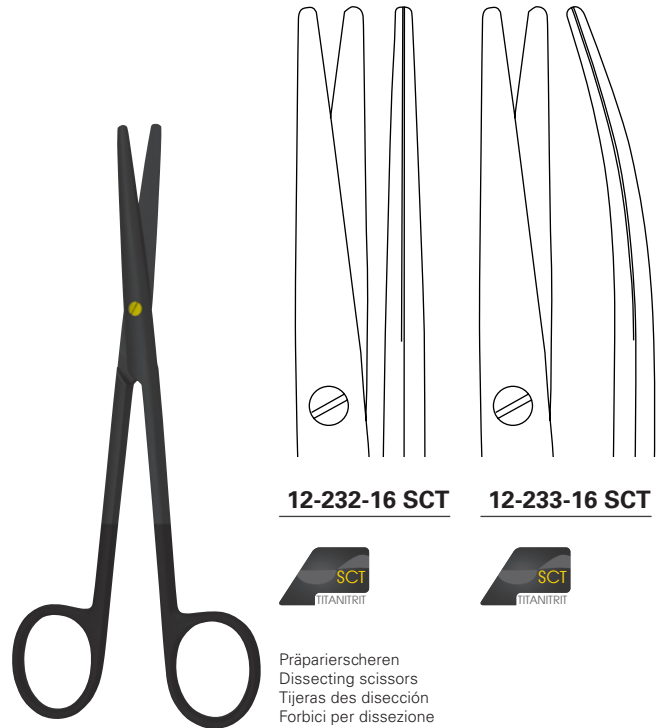


**12-221-14 SCT**

Präparierschere  
 Dissecting scissors  
 Tijera des disección  
 Forbici per dissezione

**METZENBAUM-FINO-S**

- 12-221-14 SCT** 14,0 cm, 5 <sup>1</sup>/<sub>2</sub> "



**12-232-16 SCT**

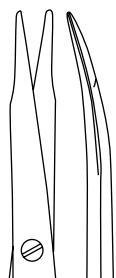
**12-233-16 SCT**



Präparierscheren  
 Dissecting scissors  
 Tijeras des disección  
 Forbici per dissezione

**LEXER**

- 12-232-16 SCT - 12-233-16 SCT** 16,0 cm, 6 <sup>1</sup>/<sub>4</sub> "



**12-247-15 SCT**

Präparierschere  
 Dissecting scissors  
 Tijera des disección  
 Forbici per dissezione

**JAMESON**

**12-247-15 SCT** 15,0 cm, 6"

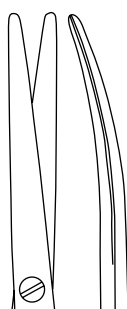


**12-249-15 SCT**

Präparierschere  
 Dissecting scissors  
 Tijera des disección  
 Forbici per dissezione

**REYNOLDS**

**12-249-15 SCT** 15,0 cm, 6"



**12-253-17 SCT**

Präparierschere  
 Dissecting scissors  
 Tijera des disección  
 Forbici per dissezione

**TOENNIS-ADSON**

**12-253-17 SCT** 17,5 cm, 7"



**12-329-13 SCT**

Nasenschere  
 Nasal scissors  
 Tijera nasales  
 Forbici nasali

**FOMON**

**12-329-13 SCT** 13,0 cm, 5 1/8"





**12-335-18 SCT**

Nasenschere  
 Nasal scissors  
 Tijera nasales  
 Forbici nasali

**HEYMANN**

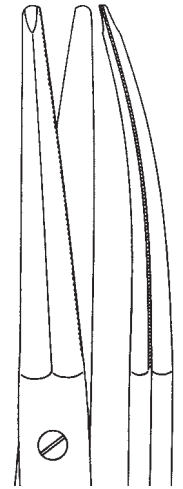
**12-335-18 SCT** 18,0 cm, 7"



**12-361-18 SCT**



Face-lift Scheren  
 Face-lift scissors  
 Tijeras para Face-lift  
 Forbici per Face-lift



**12-361-23 SCT**



**GREGORY**

**12-361-18 SCT** 18,0 cm, 7"

**12-361-23 SCT** 23,0 cm, 9"



**12-400-16 SCT**



Feine chirurgische Scheren  
 Delicate surgical scissors  
 Tijeras finas para cirugía  
 Forbici fine per chirurgia



**12-401-16 SCT**



**KELLY**

**12-400-16 SCT - 12-401-16 SCT** 16,0 cm, 6 1/4"



**12-404-14 SCT**



Feine chirurgische Scheren  
 Delicate surgical scissors  
 Tijeras finas para cirugía  
 Forbici fine per chirurgia



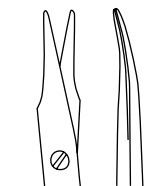
**12-405-14 SCT**



**JOSEPH**

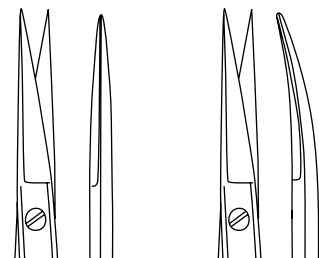
**12-404-14 SCT - 12-405-14 SCT** 14,0 cm, 5 1/2"





**12-433-11 SCT**

Feine chirurgische Scheren  
 Delicate surgical scissors  
 Tijeras finas para cirugía  
 Forbici fine per chirurgia



**12-436-11 SCT**

**12-437-11 SCT**



Feine chirurgische Scheren  
 Delicate surgical scissors  
 Tijeras finas para cirugía  
 Forbici fine per chirurgia

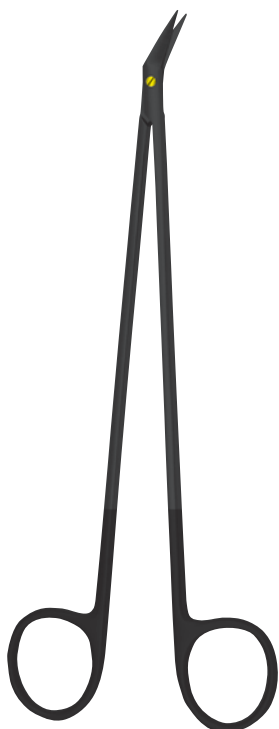
## STEVENS

**12-433-11 SCT** 11,5 cm, 4 ½"

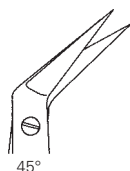


## IRIS

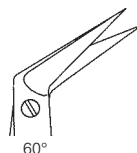
**12-436-11 SCT - 12-437-11 SCT** 11,5 cm, 4 ½"



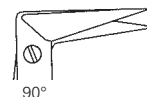
**12-571-19 SCT**



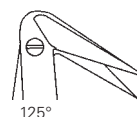
**12-573-19 SCT**



**12-575-19 SCT**



**12-577-19 SCT**



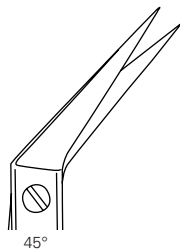
**12-579-18 SCT**



Gefäßscheren  
 Vascular scissors  
 Tijeras vasculares  
 Forbici vascolari

## HEGEMANN-DIETRICH

**12-571-19 SCT - 12-579-19 SCT** 19,0 cm, 7 ½"



**12-573-21 SCT**

Gefäßschere  
Vascular scissors  
Tijera vasculares  
Forbici vascolari

**POTTS-DE MARTEL**

**12-573-21 SCT** 21,0 cm, 8 ¼ "



# 13

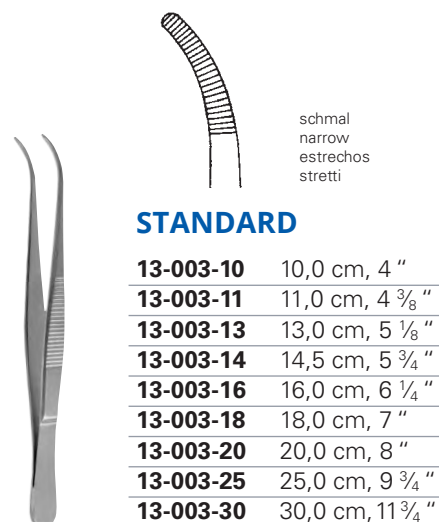
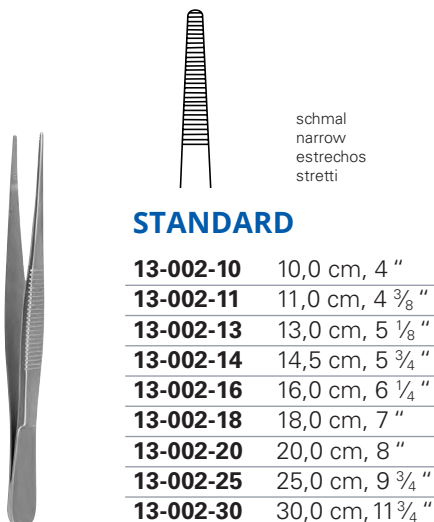
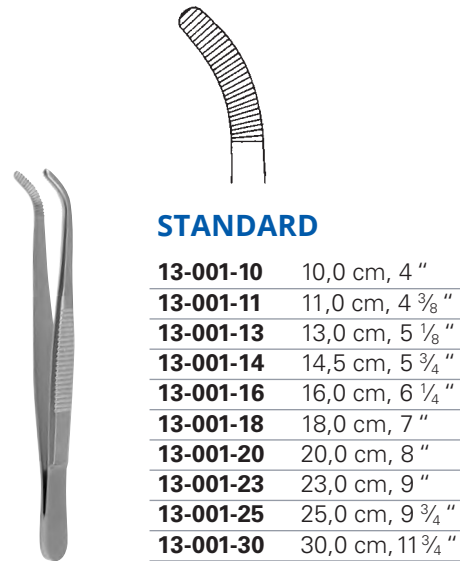
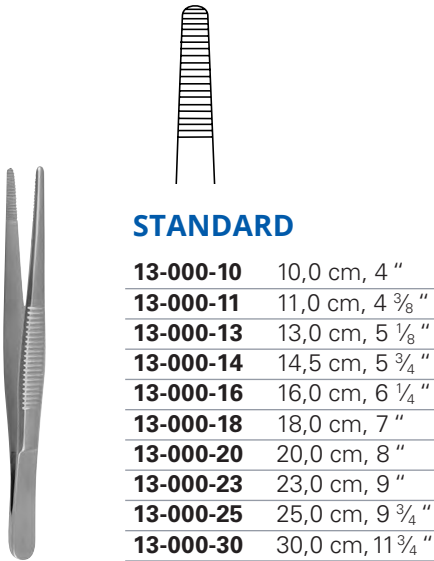
Pinzetten

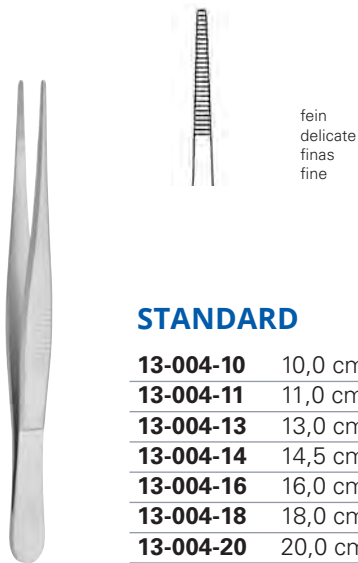
Forceps

Pinzas

Pinze



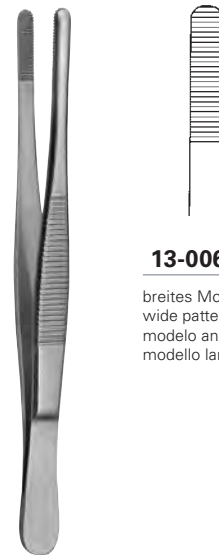




fein  
 delicate  
 finas  
 fine

### STANDARD

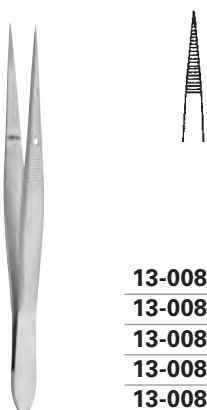
<b>13-004-10</b>	10,0 cm, 4"
<b>13-004-11</b>	11,0 cm, 4 3/8"
<b>13-004-13</b>	13,0 cm, 5 1/8"
<b>13-004-14</b>	14,5 cm, 5 3/4"
<b>13-004-16</b>	16,0 cm, 6 1/4"
<b>13-004-18</b>	18,0 cm, 7"
<b>13-004-20</b>	20,0 cm, 8"



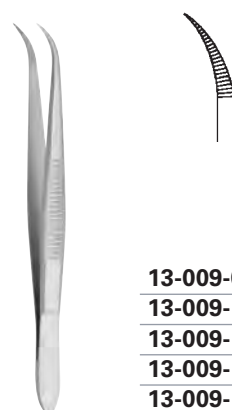
### 13-006-14

breites Modell  
 wide pattern  
 modelo ancho  
 modello largo

**13-006-14** 14,5 cm, 5 3/4"



<b>13-008-09</b>	10,5 cm, 3 1/2"
<b>13-008-10</b>	10,5 cm, 4 1/4"
<b>13-008-11</b>	11,5 cm, 4 1/2"
<b>13-008-13</b>	13,0 cm, 5 1/8"
<b>13-008-14</b>	14,5 cm, 5 3/4"



<b>13-009-09</b>	10,5 cm, 3 1/2"
<b>13-009-10</b>	10,5 cm, 4 1/4"
<b>13-009-11</b>	11,5 cm, 4 1/2"
<b>13-009-13</b>	13,0 cm, 5 1/8"
<b>13-009-14</b>	14,5 cm, 5 3/4"



**13-010-10**

**13-010-10** 10,0 cm, 4"



**13-011-10**

**13-011-10** 10,0 cm, 4"



**13-012-10**

**13-012-10** 10,0 cm, 4"



**MOD. USA**

<b>13-020-12</b>	12,0 cm, 4 3/4"
<b>13-020-13</b>	13,0 cm, 5 1/8"
<b>13-020-14</b>	14,5 cm, 5 3/4"
<b>13-020-15</b>	15,0 cm, 6"
<b>13-020-18</b>	18,0 cm, 7"
<b>13-020-21</b>	21,0 cm, 8 1/4"
<b>13-020-25</b>	25,0 cm, 9 3/4"
<b>13-020-31</b>	31,0 cm, 12 1/4"



schmal  
narrow  
estrechos  
stretti

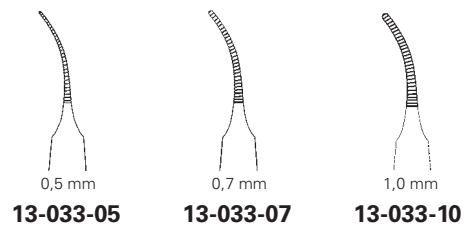
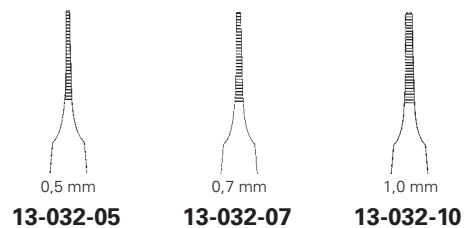
**MOD. USA**

<b>13-022-12</b>	12,0 cm, 4 3/4"
<b>13-022-13</b>	13,0 cm, 5 1/8"
<b>13-022-14</b>	14,5 cm, 5 3/4"
<b>13-022-15</b>	15,0 cm, 6"



### STILLE

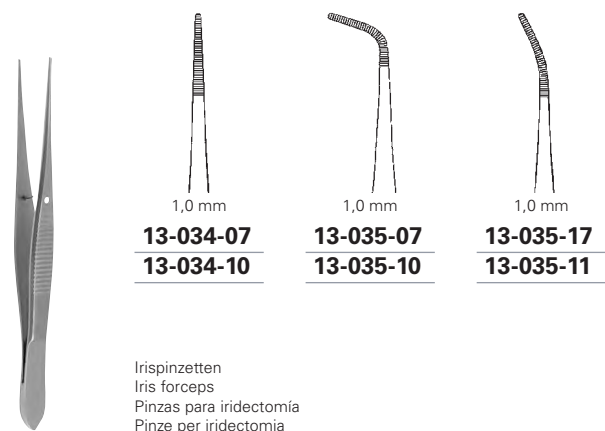
<b>13-030-11</b>	11,0 cm, 4 $\frac{3}{8}$ "
<b>13-030-13</b>	13,0 cm, 5 $\frac{1}{8}$ "
<b>13-030-15</b>	15,0 cm, 6 "
<b>13-030-17</b>	17,0 cm, 6 $\frac{3}{4}$ "
<b>13-030-20</b>	20,0 cm, 8 "



Irispinzetten  
 Iris forceps  
 Pinzas para iridectomía  
 Pinze per iridectomia

### GRAEFE

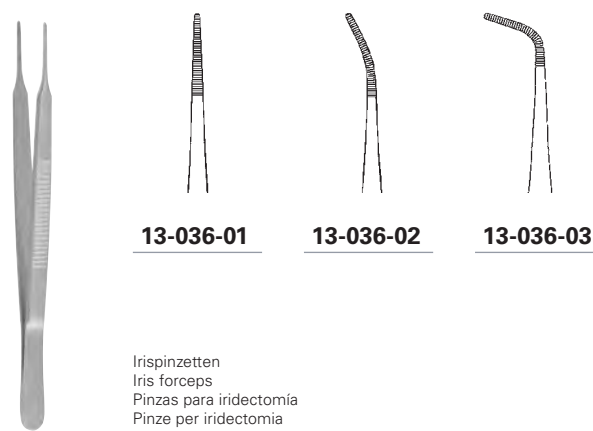
**13-032-05 - 13-033-07** 7,0 cm, 2  $\frac{3}{4}$  "



Irispinzetten  
 Iris forceps  
 Pinzas para iridectomía  
 Pinze per iridectomia

### GRAEFE

**13-034-07 - 13-035-17** 7,0 cm, 2  $\frac{3}{4}$  "  
**13-034-10 - 13-035-11** 10,0 cm, 4 "



Irispinzetten  
 Iris forceps  
 Pinzas para iridectomía  
 Pinze per iridectomia

### STEVENS

**13-036-01 - 13-036-03** 10,5 cm, 4 "



**13-036-10**

Nahtpinzette  
Suture forceps  
Pinza para sutura  
Pinze per sutura

**MOORFIELD**

**13-036-10** 10,0 cm, 4"



**13-038-11**

Nahtpinzette, schmal  
Suture forceps, narrow  
Pinza para sutura, estrechos  
Pinze per sutura, stretti

**BONACCOLTO**

**13-038-11** 10,0 cm, 4"



**13-036-11**

Nahtpinzette  
Suture forceps  
Pinza para sutura  
Pinze per sutura

**BONACCOLTO**

**13-036-11** 10,0 cm, 4"



**13-040-12**

**EWALD**

**13-040-12** 12,0 cm, 4 3/4"



**13-042-12**  
**13-042-15**  
**13-042-18**

**ADSON**

**13-042-12** 12,0 cm, 4 3/4"  
**13-042-15** 15,0 cm, 6"  
**13-042-18** 18,0 cm, 7"



**13-042-12 T**



**ADSON**

**13-042-12 T** 12,0 cm, 4 3/4"





**13-044-12**  
**13-044-15**

**ADSON-MICRO**

**13-044-12** 12,0 cm, 4 ¾"  
**13-044-15** 15,0 cm, 6"



**13-046-12**

**ADSON**

**13-046-12** 12,0 cm, 4 ¾"



**13-050-15**

**MC INDOE**

**13-050-15** 15,0 cm, 6"



**13-050-15 T**



**MC INDOE**

**13-050-15 T** 15,0 cm, 6"



**13-052-15**

**GILLIES**

**13-052-15** 15,0 cm, 6"



**13-054-12 T**



**SEMKEN**

**13-054-12 T** 12,0 cm, 4 ¾"



**13-054-12**  
**13-054-15**



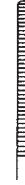
**13-055-12**  
**13-055-15**

**SEMKEN**

**13-054-12 - 13-055-12** 12,0 cm, 4 3/4"  
**13-054-15 - 13-055-15** 15,0 cm, 6"



**13-056-17**



**13-057-17**

**TAYLOR**

**13-056-17 - 13-057-17** 17,0 cm, 6 3/4"



**13-056-17 T**



**13-057-17 T**

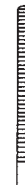


**TAYLOR**

**13-056-17 T - 13-057-17 T** 17,0 cm, 6 3/4"



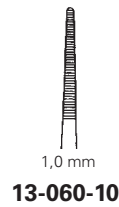
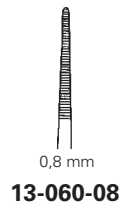
**13-058-17**



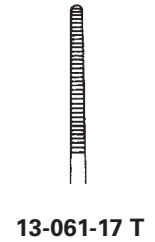
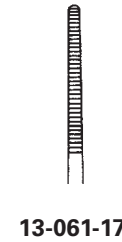
Dissektor Ende  
dissector end  
cabo disecador  
dissetore

**TAYLOR**

**13-058-17** 17,0 cm, 6 3/4"



**13-060-06 - 13-060-10** 15,5 cm, 6 1/8"



Dissektor Ende  
 dissector end  
 cabo disecador  
 dissettore



Dissektor Ende  
 dissector end  
 cabo disecador  
 dissettore

**TAYLOR**

**13-061-17** 17,0 cm, 6 3/4"

**TAYLOR**

**13-061-17 T** 17,0 cm, 6 3/4"



**POTTS-SMITH**

**13-064-18 - 13-065-18** 18,0 cm, 7"  
**13-064-21 - 13-065-21** 21,0 cm, 8 1/4"  
**13-064-25 - 13-065-25** 25,0 cm, 9 3/4"  
**13-064-30 - 13-065-30** 30,0 cm, 11 3/4"



**POTTS-SMITH**

**13-064-18 T** 18,0 cm, 7"  
**13-064-21 T** 21,0 cm, 8 1/4"  
**13-064-25 T** 25,0 cm, 9 3/4"



**13-066-17**



**13-067-17**

Dissektor Ende  
dissector end  
cabo disecador  
dissetore

**CUSHING**

**13-066-17 - 13-067-17** 17,0 cm, 6 3/4"



**13-068-20**



**13-069-20**

**BROPHY**

**13-068-20 - 13-069-20** 20,0 cm, 8"



**13-070-18**



**13-070-23**

**GERALD**

**13-070-18** 18,0 cm, 7"

**13-070-23** 23,0 cm, 9"



**13-070-18 T**



**GERALD**

**13-070-18 T** 18,0 cm, 7"



**13-071-18**



**GERALD**

**13-071-18** 18,0 cm, 7"



**13-072-20**

**DUEHRSEN**

**13-072-20** 20,0 cm, 8 "



**13-074-14**

**OCHSNIER**

**13-074-14** 14,5 cm, 5 3/4 "



**13-074-18**  
**13-074-20**

**13-074-18** 18,0 cm, 7 "  
**13-074-20** 20,0 cm, 8 "



**13-075-18**

**BONNEY**

**13-075-18** 18,0 cm, 7 "



**13-084-15**  
**13-084-20**  
**13-084-25**  
**13-084-30**

Gewebefasspinzetten  
 Tissue grasping forceps  
 Pinzas para agrrar tejidos  
 Pinze per afferrare tessuti

**MOD. RUSSIAN**

**13-084-15** 15,0 cm, 6 "  
**13-084-20** 20,0 cm, 8 "  
**13-084-25** 25,0 cm, 9 3/4 "  
**13-084-30** 30,0 cm, 11 3/4 "



**13-084-23**

Gewebefasspinzette  
 Tissue grasping forceps  
 Pinza para agrrar tejidos  
 Pinze per afferrare tessuti

**MAYO-RUSSIAN**

**13-084-23** 23,0 cm, 9 "



**13-086-23**

Gewebefasspinzette  
Tissue grasping forceps  
Pinza para agrrar tejidos  
Pinze per afferrare tessuti



**13-088-18**  
**13-088-23**

Gewebefasspinzette  
Tissue grasping forceps  
Pinza para agrrar tejidos  
Pinze per afferrare tessuti



**13-090-19**

Gewebefasspinzette  
Tissue grasping forceps  
Pinza para agrrar tejidos  
Pinze per afferrare tessuti



**13-092-13**  
**13-092-16**

**WANGENSTEEN**

**13-086-23** 23,0 cm, 9"

**SINGLEY-TUTTLE**

**13-088-18** 18,0 cm, 7"  
**13-088-23** 23,0 cm, 9"

**DENNIS-BROWNE**

**13-090-19** 19,0 cm, 7 1/2"

**STANDARD**

**13-092-13** 13,0 cm, 5 1/8"  
**13-092-16** 16,0 cm, 6 1/4"



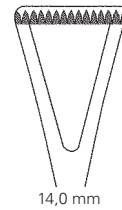
**13-094-15**  
**13-094-20**  
**13-094-25**

Fasspinzette  
Tissue forceps  
Pinza para agrrar  
Pinze da presa

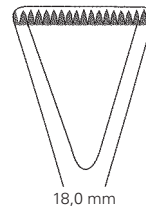


**13-096-14**

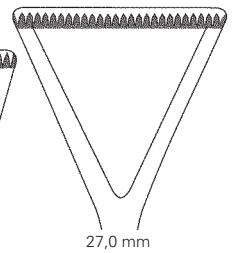
Fasspinzette  
Tissue forceps  
Pinza para agrrar  
Pinze da presa



14,0 mm  
**13-098-01**



18,0 mm  
**13-098-02**



27,0 mm  
**13-098-03**

Fasspinzetten  
Tissue forceps  
Pinzas para agrrar  
Pinze da presa

**SELMANN**

**13-094-15** 16,0 cm, 6 1/4"  
**13-094-20** 20,0 cm, 8"  
**13-094-25** 25,0 cm, 9 3/4"

**DUVAL**

**13-096-14** 14,0 cm, 5 1/2"

**COLLIN-DUVAL**

**13-098-01 - 13-098-03** 20,0 cm, 8"



1 x 2



### STANDARD

<b>13-100-10</b>	10,0 cm, 4 "
<b>13-100-11</b>	11,0 cm, 4 $\frac{3}{8}$ "
<b>13-100-13</b>	13,0 cm, 5 $\frac{1}{8}$ "
<b>13-100-14</b>	14,5 cm, 5 $\frac{3}{4}$ "
<b>13-100-16</b>	16,0 cm, 6 $\frac{1}{4}$ "
<b>13-100-18</b>	18,0 cm, 7 "
<b>13-100-20</b>	20,0 cm, 8 "
<b>13-100-23</b>	23,0 cm, 9 "
<b>13-100-25</b>	25,0 cm, 9 $\frac{3}{4}$ "
<b>13-100-30</b>	30,0 cm, 11 $\frac{3}{4}$ "

1 x 2



schmal  
narrow  
estrechos  
stretti



### STANDARD

<b>13-102-11</b>	11,0 cm, 4 $\frac{3}{8}$ "
<b>13-102-13</b>	13,0 cm, 5 $\frac{1}{8}$ "
<b>13-102-14</b>	14,5 cm, 5 $\frac{3}{4}$ "
<b>13-102-16</b>	16,0 cm, 6 $\frac{1}{4}$ "
<b>13-102-18</b>	18,0 cm, 7 "
<b>13-102-20</b>	20,0 cm, 8 "
<b>13-102-25</b>	25,0 cm, 9 $\frac{3}{4}$ "
<b>13-102-30</b>	30,0 cm, 11 $\frac{3}{4}$ "

1 x 2



schmal  
narrow  
estrechos  
stretti



### STANDARD

<b>13-103-11</b>	11,0 cm, 4 $\frac{3}{8}$ "
<b>13-103-13</b>	13,0 cm, 5 $\frac{1}{8}$ "
<b>13-103-14</b>	14,5 cm, 5 $\frac{3}{4}$ "
<b>13-103-16</b>	16,0 cm, 6 $\frac{1}{4}$ "
<b>13-103-18</b>	18,0 cm, 7 "
<b>13-103-20</b>	20,0 cm, 8 "
<b>13-103-25</b>	25,0 cm, 9 $\frac{3}{4}$ "
<b>13-103-30</b>	30,0 cm, 11 $\frac{3}{4}$ "

1 x 2



fein  
delicate  
finas  
fine



### STANDARD

<b>13-104-13</b>	13,0 cm, 5 $\frac{1}{8}$ "
<b>13-104-14</b>	14,5 cm, 5 $\frac{3}{4}$ "
<b>13-104-16</b>	16,0 cm, 6 $\frac{1}{4}$ "
<b>13-104-18</b>	18,0 cm, 7 "
<b>13-104-20</b>	20,0 cm, 8 "



1 x 2



**13-106-18**  
**13-106-20**  
**13-106-25**  
**13-106-30**

**WAUGH**

<b>13-106-18</b>	18,0 cm, 7"
<b>13-106-20</b>	20,0 cm, 8"
<b>13-106-25</b>	25,0 cm, 9 3/4"
<b>13-106-30</b>	30,0 cm, 11 3/4"



1 x 2



**13-108-14**  
**13-108-16**

mittel  
medium  
media  
mezzo

**STANDARD**

<b>13-108-14</b>	14,0 cm, 5 1/2"
<b>13-108-16</b>	16,0 cm, 6 1/4"



2 x 3



**MOD. USA**

<b>13-120-11</b>	11,0 cm, 4 3/8"
<b>13-120-13</b>	13,0 cm, 5 1/8"
<b>13-120-14</b>	14,5 cm, 5 3/4"
<b>13-120-15</b>	15,0 cm, 6"
<b>13-120-18</b>	18,0 cm, 7"
<b>13-120-20</b>	20,0 cm, 8"
<b>13-120-25</b>	25,0 cm, 9 3/4"
<b>13-120-30</b>	30,0 cm, 11 3/4"



1 x 2



**MOD. USA**

<b>13-122-12</b>	12,0 cm, 4 3/4"
<b>13-122-13</b>	13,0 cm, 5 1/8"
<b>13-122-14</b>	14,5 cm, 5 3/4"
<b>13-122-15</b>	15,0 cm, 6"
<b>13-122-18</b>	18,0 cm, 7"
<b>13-122-21</b>	21,0 cm, 9 1/4"
<b>13-122-25</b>	25,0 cm, 9 3/4"
<b>13-122-31</b>	31,0 cm, 12 1/4"





2 x 3



### STANDARD

<b>13-124-11</b>	11,0 cm, 4 3/8"
<b>13-124-13</b>	13,0 cm, 5 1/8"
<b>13-124-14</b>	14,0 cm, 5 1/2"
<b>13-124-15</b>	15,0 cm, 6 1/8"
<b>13-124-16</b>	16,0 cm, 6 1/4"
<b>13-124-18</b>	18,0 cm, 7"
<b>13-124-20</b>	20,0 cm, 8"
<b>13-124-25</b>	25,0 cm, 9 3/4"
<b>13-124-30</b>	30,0 cm, 11 3/4"

3 x 4



### STANDARD

<b>13-126-13</b>	13,0 cm, 5 1/8"
<b>13-126-14</b>	14,0 cm, 5 1/2"
<b>13-126-15</b>	15,0 cm, 6 1/8"
<b>13-126-16</b>	16,0 cm, 6 1/4"
<b>13-126-20</b>	20,0 cm, 8"

4 x 5



<b>13-128-13</b>
<b>13-128-14</b>
<b>13-128-16</b>

### STANDARD

<b>13-128-13</b>	13,0 cm, 5 1/8"
<b>13-128-14</b>	14,0 cm, 5 1/2"
<b>13-128-16</b>	16,0 cm, 6 1/4"

1 x 2



**13-129-15**

### STILLE

<b>13-129-15</b>	15,0 cm, 6 1/8"
------------------	-----------------

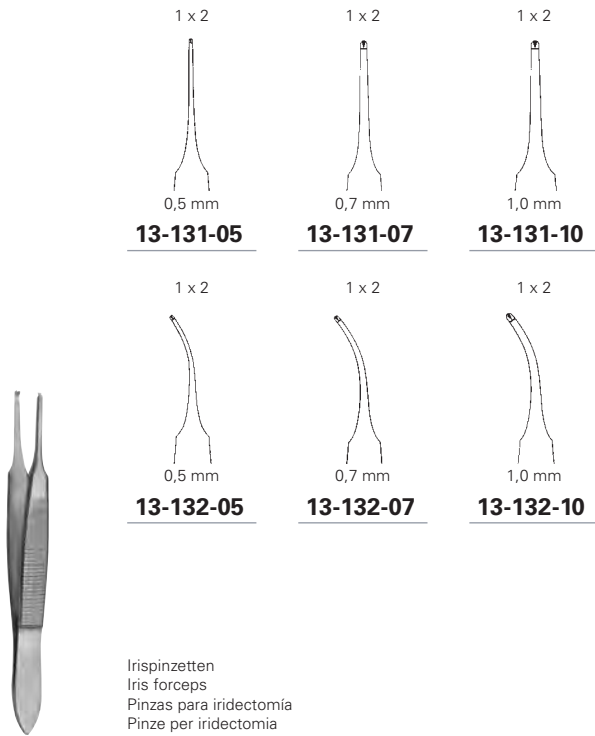
2 x 3



**13-130-15**

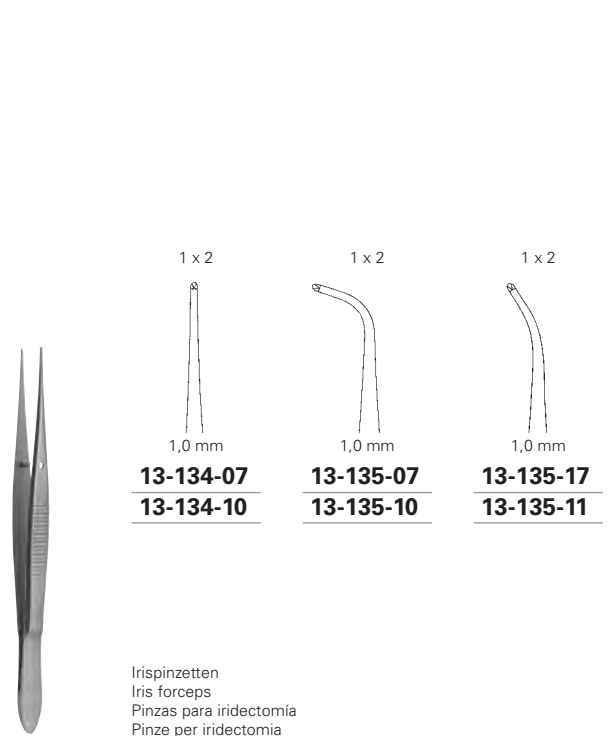
### STILLE

<b>13-130-15</b>	15,0 cm, 6 1/8"
------------------	-----------------



**GRAEFE**

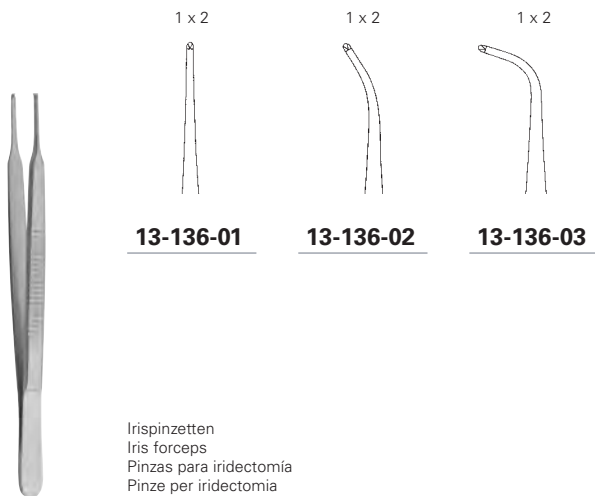
**13-131-05 - 13-131-07** 7,0 cm, 2 3/4"



**GRAEFE**

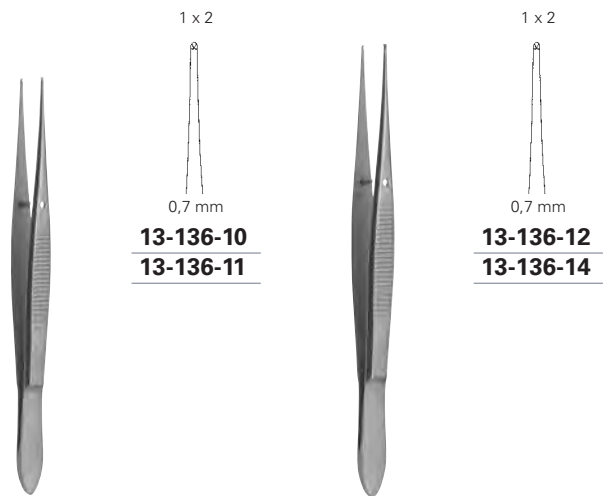
**13-134-07 - 13-135-17** 7,0 cm, 2 3/4"

**13-134-10 - 13-135-11** 10,0 cm, 4"



**STEVENS**

**13-136-01 - 13-136-03** 10,5 cm, 4"



**SEMKEN**

**13-136-10** 10,0 cm, 4"

**13-136-11** 11,0 cm, 4 3/8"

**13-136-12** 12,5 cm, 5"

**13-136-14** 14,5 cm, 5 3/4"



**13-138-10**

Gewebefasspinzette  
Tissue grasping forceps  
Pinza para agrrar tejidos  
Pinze per afferrare tessuti

**GRAEFE**

**13-138-10** 10,0 cm, 4 "



**13-138-11**

Gewebefasspinzette  
Tissue grasping forceps  
Pinza para agrrar tejidos  
Pinze per afferrare tessuti

**GRAEFE**

**13-138-11** 10,0 cm, 4 "



**13-140-12**

1 x 2



**EWALD**

**13-140-12** 12,0 cm, 4 3/4 "



**13-141-12**  
**13-141-15**

1 x 2



**ADSON**

**13-141-12** 12,0 cm, 4 3/4 "  
**13-141-15** 15,0 cm, 6 "



**13-142-12**  
**13-142-15**  
**13-142-18**

1 x 2



**ADSON**

**13-142-12** 12,0 cm, 4 3/4 "  
**13-142-15** 15,0 cm, 6 "  
**13-142-18** 18,0 cm, 7 "



**13-142-12 T**

1 x 2



**ADSON**

**13-142-12 T** 12,0 cm, 4 3/4 "

2 x 3



**13-142-22**  
**13-142-25**

**ADSON**

**13-142-22** 12,0 cm, 4 3/4"  
**13-142-25** 15,0 cm, 6"

1 x 2



**13-143-12**

**ADSON-MICRO**

**13-143-12** 12,0 cm, 4 3/4"

1 x 2



**13-144-12**  
**13-144-15**

**ADSON-MICRO**

**13-144-12** 12,0 cm, 4 3/4"  
**13-144-15** 15,0 cm, 6"

1 x 2



**13-145-12**

**ADSON**

**13-145-12** 12,0 cm, 4 3/4"

1 x 2



**13-146-12**

**ADSON-MINI**

**13-146-12** 12,0 cm, 4 3/4"

1 x 2



**13-147-12**

**ADSON-MICRO**

**13-147-12** 12,0 cm, 4 3/4"



1 x 2



**13-148-12**

**ADSON-MICRO**

**13-148-12** 12,0 cm, 4 3/4"

1 x 2



**13-149-12**

**ADSON-BIEMER-MICRO**

**13-149-12** 12,0 cm, 4 3/4"

1 x 2



**13-150-15**

**MC INDOE**

**13-150-15** 15,0 cm, 6"

1 x 2



**13-152-15**

**GILLIES**

**13-152-15** 15,0 cm, 6"

1 x 2



**13-152-15 T**

**GILLIES**

**13-152-15 T** 15,0 cm, 6"



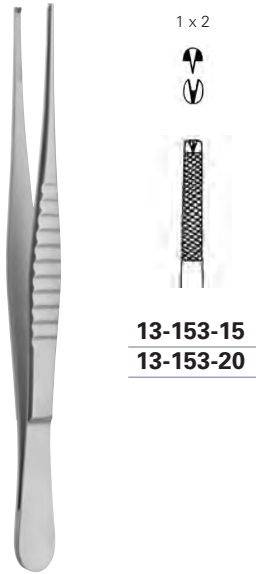
1 x 2



**13-152-16**

**GILLIES**

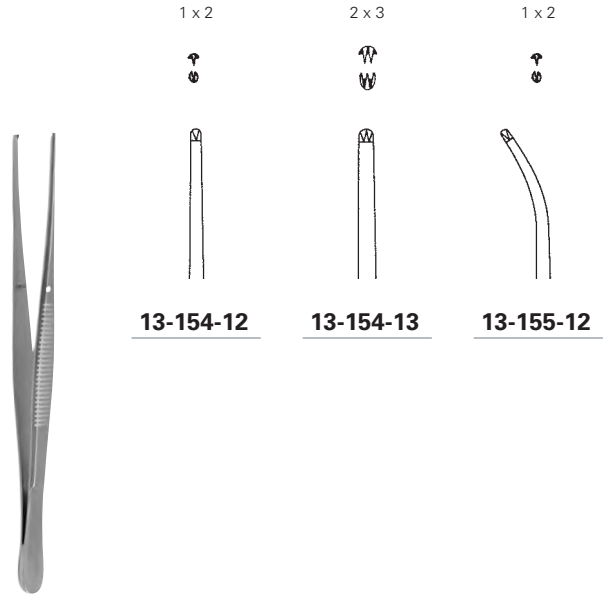
**13-152-16** 15,5 cm, 6 1/8"



**13-153-15**  
**13-153-20**

**MOD. STRASSBURG**

**13-153-15** 15,0 cm, 6"  
**13-153-20** 20,0 cm, 8"



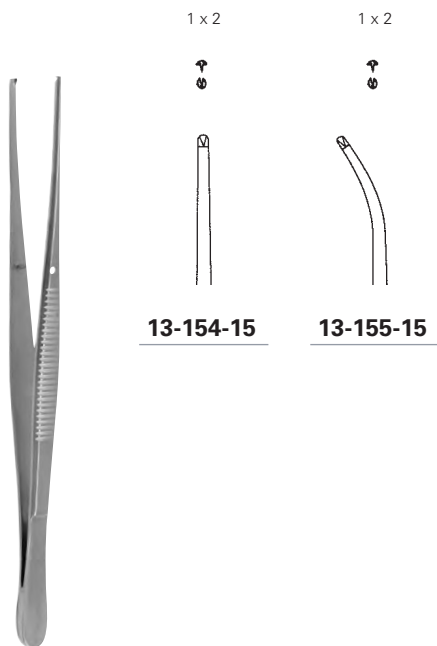
**13-154-12**

**13-154-13**

**13-155-12**

**SEMKEN**

**13-154-12 - 13-155-12** 12,5 cm, 5"

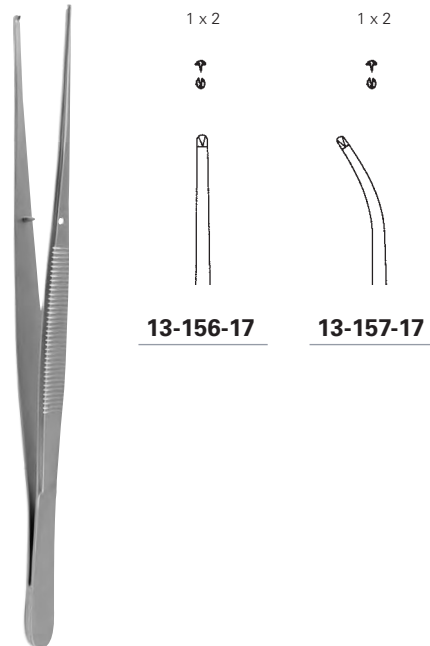


**13-154-15**

**13-155-15**

**SEMKEN**

**13-154-15 - 13-155-15** 15,0 cm, 6"

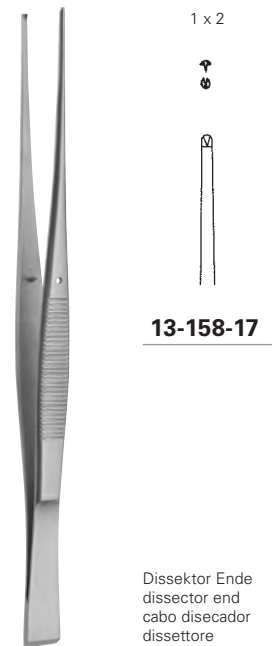


**13-156-17**

**13-157-17**

**TAYLOR**

**13-156-17 - 13-157-17** 17,0 cm, 6 3/4"



**13-158-17**

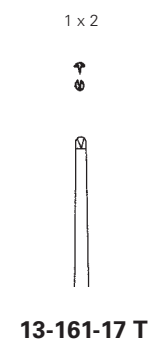
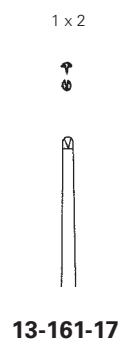
**TAYLOR**

**13-158-17** 17,0 cm, 6 3/4"

Dissektor Ende  
dissector end  
cabo disecador  
dissettore



**13-160-06 - 13-160-10** 15,0 cm, 6 "



Dissektor Ende  
dissector end  
cabo disecador  
dissettore



Dissektor Ende  
dissector end  
cabo disecador  
dissettore

### TAYLOR

**13-161-17** 17,0 cm, 6 3/4 "

### TAYLOR

**13-161-17 T** 17,0 cm, 6 3/4 "



### POTTS-SMITH

**13-164-18 - 13-165-18** 18,0 cm, 7 "

**13-164-21 - 13-165-21** 21,0 cm, 8 1/4 "

**13-164-25 - 13-165-25** 25,0 cm, 9 3/4 "

**13-164-30 - 13-165-30** 30,0 cm, 11 3/4 "



Dissektor Ende  
dissector end  
cabo disecador  
dissettore

### CUSHING

**13-166-17 - 13-167-17** 17,0 cm, 6 3/4 "



1 x 2



**13-168-20**

1 x 2



**13-169-20**

**BROPHY**

**13-168-20 - 13-169-20** 20,0 cm, 8"



1 x 2



**13-170-18**  
**13-170-23**

**GERALD**

**13-170-18** 18,0 cm, 7"

**13-170-23** 23,0 cm, 9"



1 x 2



**13-170-18 T**



**GERALD**

**13-170-18 T** 18,0 cm, 7"



1 x 2



**13-171-18**

**GERALD**

**13-171-18** 18,0 cm, 7"



4 x 5



**13-172-15**  
**13-172-20**  
**13-172-25**

Gefäß- und Tumorzinnetten  
Vascular and tumor forceps  
Pinzas para vasos y tumores  
Pinza vascolare e per tumori

**ADLERKREUTZ**

**13-172-15** 15,0 cm, 6"

**13-172-20** 20,0 cm, 9"

**13-172-25** 25,0 cm, 9 3/4"



2 x 3



**13-173-15**  
**13-173-20**  
**13-173-25**

Gefäß- und Tumorzinnetten  
Vascular and tumor forceps  
Pinzas para vasos y tumores  
Pinza vascolare e per tumori

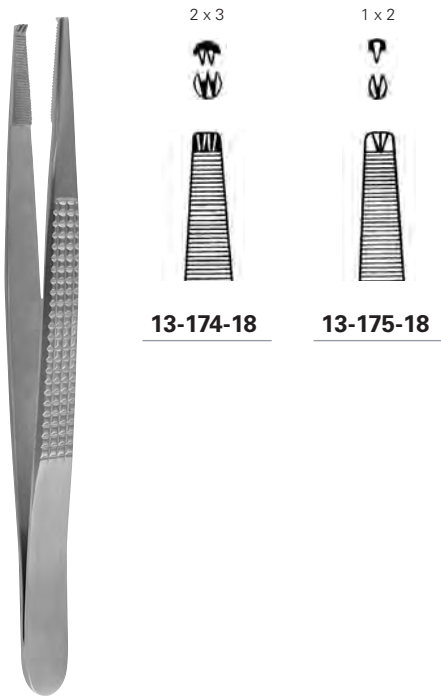
**ADLERKREUTZ**

**13-173-15** 15,0 cm, 6"

**13-173-20** 20,0 cm, 9"

**13-173-25** 25,0 cm, 9 3/4"



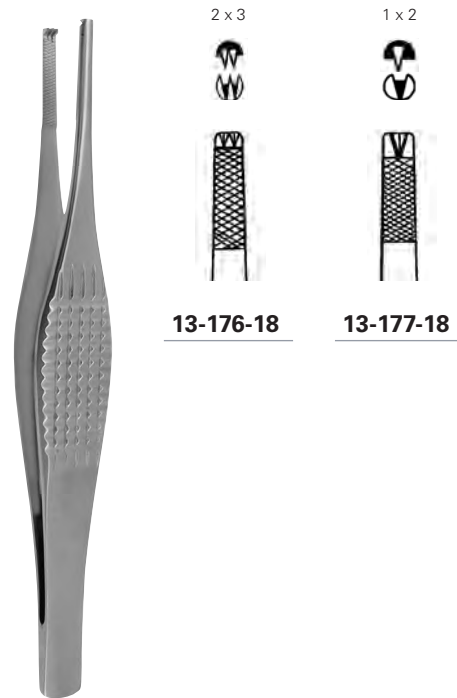


**13-174-18**

**13-175-18**

**BONNEY**

**13-174-18 - 13-175-18** 18,0 cm, 7 "

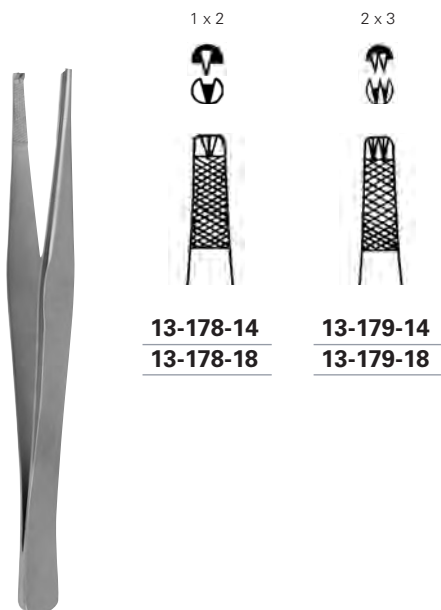


**13-176-18**

**13-177-18**

**FERRIS-SMITH**

**13-176-18 - 13-177-18** 18,0 cm, 7 "

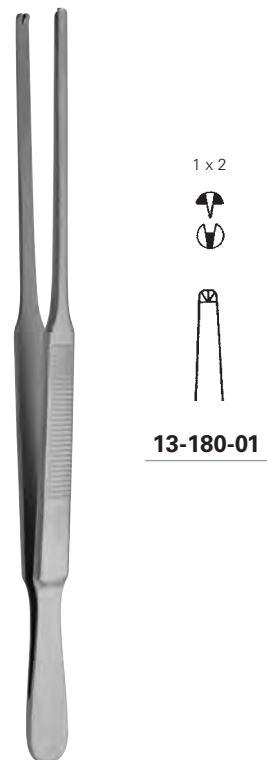


**13-178-14**  
**13-178-18**

**13-179-14**  
**13-179-18**

**LANE**

**13-178-14 - 13-179-14** 14,0 cm, 5 ½ "  
**13-178-18 - 13-179-18** 18,0 cm, 7 "



**13-180-01**

**DUEHRSEN**

**13-180-01** 20,0 cm, 8 "



1 x 2  




**13-180-12**  
**13-180-15**

**TREVES**

**13-180-12** 12,0 cm, 4 3/4"  
**13-180-15** 15,0 cm, 6"



3 x 4  




**13-182-18**  
**13-182-20**  
**13-182-25**

Gefäß- und Tumorzinnetten  
Vascular and tumor forceps  
Pinzas para vasos y tumores  
Pinza vascolare e per tumori

**STILLE-BARRAYA**

**13-182-18** 18,0 cm, 7"  
**13-182-20** 20,0 cm, 9"  
**13-182-25** 25,0 cm, 9 3/4"



6 x 7  


**13-183-15**  
**13-183-18**  
**13-183-20**  
**13-183-23**

Lungenfasszinnetten  
Lung grasping forceps  
Pinzas para agrrar pulmón  
Pinze per afferrare pulmone

**NELSON**

**13-183-15** 15,0 cm, 6"  
**13-183-18** 18,0 cm, 7"  
**13-183-20** 20,0 cm, 8"  
**13-183-23** 23,0 cm, 9"



**13-185-17**

Dissektor Ende  
dissector end  
cabo disecador  
dissettore

**TAYLOR-BROWN**

**13-185-17** 17,0 cm, 6 3/4"



**13-186-17**

Dissektor Ende  
dissector end  
cabo disecador  
dissettore

**CUSHING-BROWN**

**13-186-17** 17,0 cm, 6 3/4"



**13-187-17**

**GERALD-BROWN**

**13-187-17** 17,0 cm, 6 3/4"



**13-188-15**  
**13-188-20**  
**13-188-25**

Gewebefasspinzetten  
Tissue grasping forceps  
Pinza para agrrar tejidos  
Pinze per afferrare tessuti

## BROWN

**13-188-15** 15,0 cm, 6"  
**13-188-20** 20,0 cm, 9"  
**13-188-25** 25,0 cm, 9 3/4"

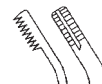


9 x 9



**13-190-12**

9 x 9



**13-193-12**

## ADSON-BROWN

**13-190-12 - 13-193-12** 12,0 cm, 4 3/4"



9 x 9



**13-190-12 T**



## ADSON-BROWN

**13-190-12 T** 12,0 cm, 4 3/4"



7 x 7



**13-191-12**  
**13-191-15**

## ADSON-BROWN

**13-191-12** 12,0 cm, 4 3/4"  
**13-191-15** 15,0 cm, 6"



**13-192-12**

## ADSON-GRAEFE

**13-192-12** 12,0 cm, 4 3/4"



4 x 5



**13-194-15**

**STONE**

**13-194-15** 15,0 cm, 6 "



5 x 6



**13-196-15**

**LERCHE**

**13-196-15** 15,0 cm, 6 "



6 x 7



**13-198-14**  
**13-198-16**  
**13-198-20**  
**13-198-25**

Gefäß- und Tumorzinnetten  
 Vascular and tumor forceps  
 Pinzas para vasos y tumores  
 Pinza vascolare e per tumori

**DURANTE**

**13-198-14** 14,0 cm, 5 1/2 "  
**13-198-16** 16,0 cm, 6 1/4 "  
**13-198-20** 20,0 cm, 8 "  
**13-198-25** 25,0 cm, 9 3/4 "



1,5 mm

**13-200-01**  
**13-200-02**



**ADSON-DE BAKAY**

**13-200-01** 12,0 cm, 4 3/4 "  
**13-200-02** 15,0 cm, 6 "



1,5 mm

**13-200-02 T**



**ADSON-DE BAKAY**

**13-200-02 T** 15,0 cm, 6 "



4,0 mm

**13-214-15**



8,0 mm

**13-214-24**



**GLASSMANN**

**13-214-15** 15,0 cm, 6 "  
**13-214-24** 24,0 cm, 9 1/2 "



### DE BAKAY

Gesamtlänge  
 Total length  
 Longitud total  
 Lunghezza totale



1,0 mm



1,5 mm



1,5 mm



2,0 mm



2,0 mm



16,5 cm, 6 1/2"	<b>13-212-16</b>	<b>13-210-16</b>	<b>13-211-16</b>	<b>13-208-16</b>	<b>13-209-16</b>
20,0 cm, 8"	<b>13-212-20</b>	<b>13-210-20</b>	<b>13-211-20</b>	<b>13-208-20</b>	<b>13-209-20</b>
24,0 cm, 9 1/2"	<b>13-212-24</b>	<b>13-210-24</b>	<b>13-211-24</b>	<b>13-208-24</b>	<b>13-209-24</b>
30,0 cm, 11 3/4"		<b>13-210-30</b>	<b>13-211-30</b>	<b>13-208-30</b>	<b>13-209-30</b>



### DE BAKAY

Gesamtlänge  
 Total length  
 Longitud total  
 Lunghezza totale



2,4 mm



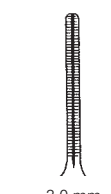
2,8 mm



3,5 mm



3,5 mm



2,0 mm



### COOLEY

16,5 cm, 6 1/2"	<b>13-206-16</b>	<b>13-204-16</b>	<b>13-200-16</b>	<b>13-202-16</b>	<b>13-230-16</b>
20,0 cm, 8"	<b>13-206-20</b>	<b>13-204-20</b>	<b>13-200-20</b>	<b>13-202-20</b>	<b>13-230-20</b>
24,0 cm, 9 1/2"	<b>13-206-24</b>	<b>13-204-24</b>	<b>13-200-24</b>	<b>13-202-24</b>	<b>13-230-24</b>
30,0 cm, 11 3/4"	<b>13-206-30</b>	<b>13-204-30</b>	<b>13-200-30</b>	<b>13-202-30</b>	



**DE BAKEY**

Gesamtlänge  
Total length  
Longitud total  
Lunghezza totale



15,0 cm, 6 "	<b>13-240-15</b>	<b>13-242-15</b>	<b>13-244-15</b>	<b>13-246-15</b>	<b>13-247-15</b>
20,0 cm, 8 "	<b>13-240-20</b>	<b>13-242-20</b>	<b>13-244-20</b>	<b>13-246-20</b>	<b>13-247-20</b>
24,0 cm, 9 ½ "	<b>13-240-24</b>	<b>13-242-24</b>	<b>13-244-24</b>	<b>13-246-24</b>	<b>13-247-24</b>
30,0 cm, 11 ¾ "				<b>13-246-30</b>	<b>13-247-30</b>



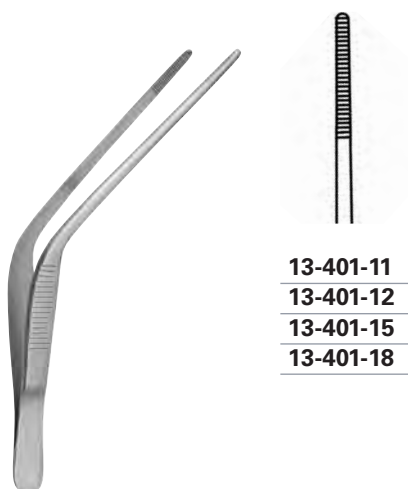
**DE BAKEY**

Gesamtlänge  
Total length  
Longitud total  
Lunghezza totale



**COOLEY**

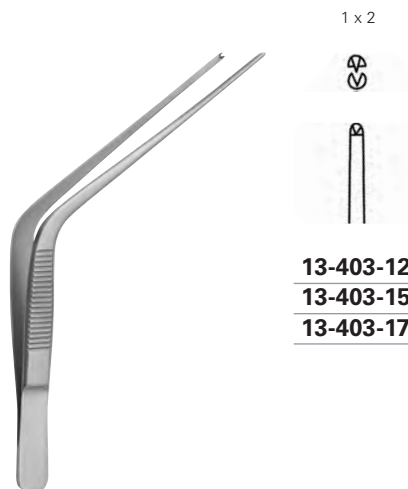
16,5 cm, 6 ½ "	<b>13-248-15</b>		<b>13-250-15</b>	<b>13-252-15</b>	<b>13-232-16 T</b>
20,0 cm, 8 "	<b>13-248-20</b>	<b>13-249-20</b>	<b>13-250-20</b>	<b>13-252-20</b>	<b>13-230-20 T</b>
24,0 cm, 9 ½ "	<b>13-248-24</b>		<b>13-250-24</b>	<b>13-252-24</b>	<b>13-230-24 T</b>
30,0 cm, 11 ¾ "	<b>13-248-30</b>		<b>13-250-30</b>	<b>13-252-30</b>	



**13-401-11**  
**13-401-12**  
**13-401-15**  
**13-401-18**

### TROELTSCH

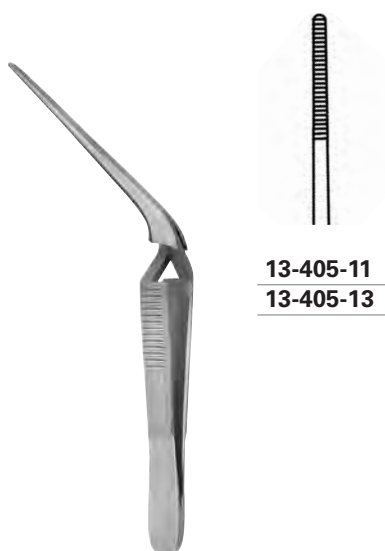
<b>13-401-11</b>	11,0 cm, 4 $\frac{3}{8}$ "
<b>13-401-12</b>	12,0 cm, 4 $\frac{3}{4}$ "
<b>13-401-15</b>	15,0 cm, 6 "
<b>13-401-18</b>	18,0 cm, 7 "



**13-403-12**  
**13-403-15**  
**13-403-17**

### TROELTSCH

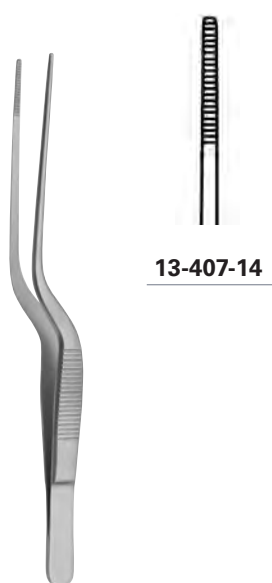
<b>13-403-12</b>	12,0 cm, 4 $\frac{3}{4}$ "
<b>13-403-15</b>	15,0 cm, 6 "
<b>13-403-17</b>	17,0 cm, 6 $\frac{3}{4}$ "



**13-405-11**  
**13-405-13**

### TROELTSCH-JALASVIRTA

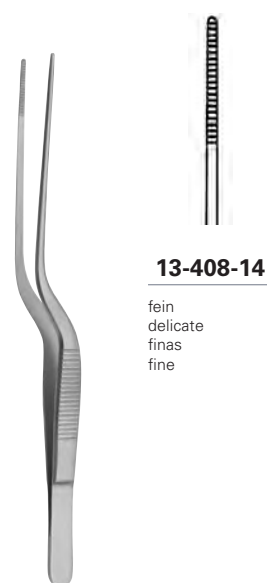
<b>13-405-11</b>	11,0 cm, 4 $\frac{3}{8}$ "
<b>13-405-13</b>	13,0 cm, 5 $\frac{1}{8}$ "



**13-407-14**

### LUCAE

<b>13-407-14</b>	14,0 cm, 5 $\frac{1}{2}$ "
------------------	----------------------------

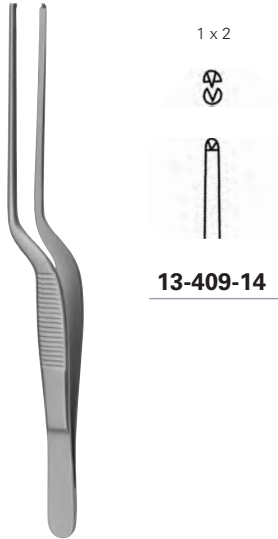


**13-408-14**

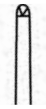
fein  
 delicate  
 finas  
 fine

### LUCAE

<b>13-408-14</b>	14,0 cm, 5 $\frac{1}{2}$ "
------------------	----------------------------



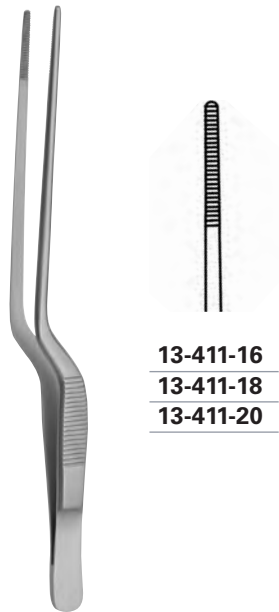
1 x 2



**13-409-14**

**LUCAE**

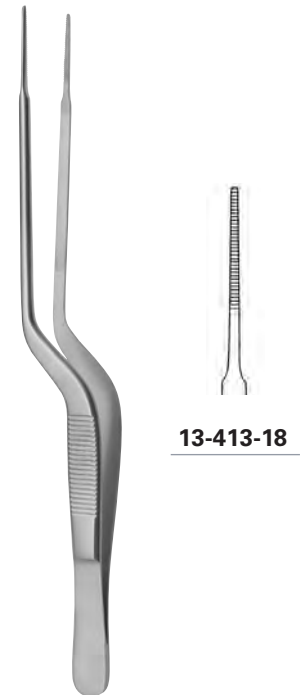
**13-409-14** 14,0 cm, 5 1/2"



**13-411-16**  
**13-411-18**  
**13-411-20**

**JANSEN**

**13-411-16** 16,0 cm, 6 1/4"  
**13-411-18** 18,0 cm, 7"  
**13-411-20** 20,0 cm, 8"



**13-413-18**

**GERALD**

**13-413-18** 18,0 cm, 7"



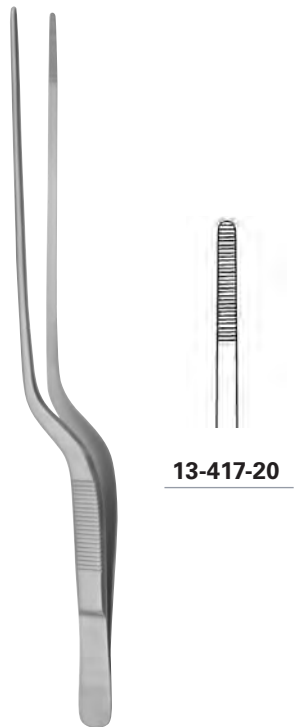
1 x 2



**13-415-18**

**GERALD**

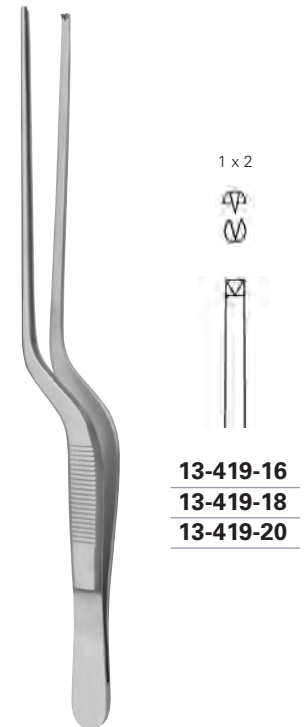
**13-415-18** 18,0 cm, 7"



**13-417-20**

**GRUENWALD-JANSEN**

**13-417-20** 20,0 cm, 8"



1 x 2



**13-419-16**  
**13-419-18**  
**13-419-20**

**GRUENWALD-JANSEN**

**13-419-16** 16,0 cm, 6 1/4"  
**13-419-18** 18,0 cm, 7"  
**13-419-20** 20,0 cm, 8"





**13-500-09**

**DOUGLAS**

**13-500-09** 9,0 cm, 3 1/2"



**13-502-09**

**SHAAF**

**13-502-09** 9,0 cm, 3 1/2"



**13-504-09**

**BEER**

**13-504-09** 9,0 cm, 3 1/2"



**13-506-09**

**ZIEGLER**

**13-506-09** 9,0 cm, 3 1/2"



**13-508-09**

**13-508-09** 9,0 cm, 3 1/2"



**13-510-08**

**LITTAUER**

**13-510-08** 8,5 cm, 3 1/3"



**13-511-10**

**BARRAQUER**

**13-511-10** 10,5 cm, 4 1/4"





<b>13-512-08</b>	8,0 cm, 3 1/8"
<b>13-512-09</b>	9,0 cm, 3 1/2"
<b>13-512-10</b>	10,0 cm, 4"
<b>13-512-11</b>	11,0 cm, 4 3/8"
<b>13-512-12</b>	12,0 cm, 4 3/4"
<b>13-512-14</b>	14,0 cm, 5 1/2"



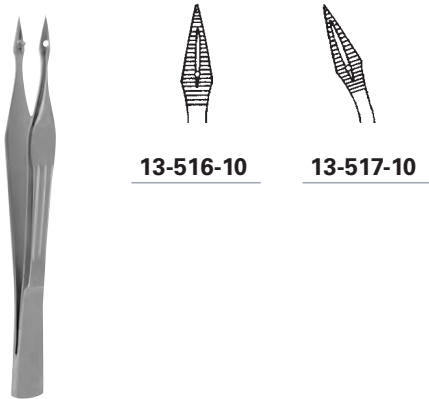
<b>13-513-08</b>	8,0 cm, 3 1/8"
<b>13-513-09</b>	9,0 cm, 3 1/2"
<b>13-513-10</b>	10,0 cm, 4"
<b>13-513-11</b>	11,0 cm, 4 3/8"
<b>13-513-12</b>	12,0 cm, 4 3/4"
<b>13-513-14</b>	14,0 cm, 5 1/2"



<b>13-514-08</b>	8,0 cm, 3 1/8"
<b>13-514-09</b>	9,0 cm, 3 1/2"
<b>13-514-10</b>	10,0 cm, 4"
<b>13-514-11</b>	11,0 cm, 4 3/8"
<b>13-514-12</b>	12,0 cm, 4 3/4"
<b>13-514-14</b>	14,0 cm, 5 1/2"



<b>13-515-08</b>	8,0 cm, 3 1/8"
<b>13-515-09</b>	9,0 cm, 3 1/2"
<b>13-515-10</b>	10,0 cm, 4"
<b>13-515-11</b>	11,0 cm, 4 3/8"
<b>13-515-12</b>	12,0 cm, 4 3/4"
<b>13-515-14</b>	14,0 cm, 5 1/2"

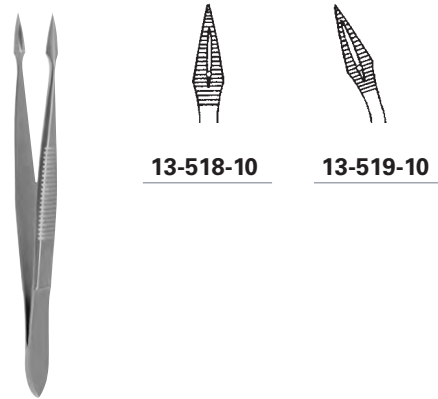


**13-516-10**

**13-517-10**

### CARMALT

**13-516-10 - 13-517-10** 10,0 cm, 4 "

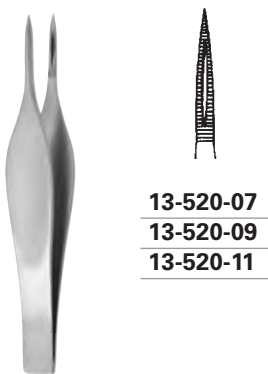


**13-518-10**

**13-519-10**

### HUNTER

**13-518-10 - 13-519-10** 10,0 cm, 4 "



**13-520-07**

**13-520-09**

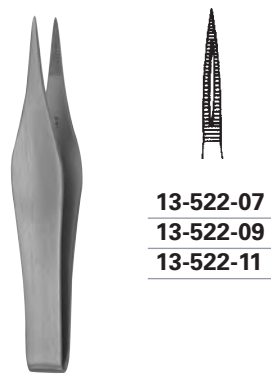
**13-520-11**

### FEILCHENFELD

**13-520-07** 7,5 cm, 3 "

**13-520-09** 9,0 cm, 3 ½ "

**13-520-11** 11,5 cm, 4 ½ "



**13-522-07**

**13-522-09**

**13-522-11**

### FEILCHENFELD

**13-522-07** 7,5 cm, 3 "

**13-522-09** 9,0 cm, 3 ½ "

**13-522-11** 11,5 cm, 4 ½ "



**13-528-12** 12,0 cm, 4 ¾ "



**13-540-10**



**13-541-10**

Deckglaspinzetten  
 Cover glass forceps  
 Pinzas porta-laminillas  
 Pinze porta-lamelle



Zeckenpinzetten  
 Ticks forceps  
 Pinzas garrapata  
 Pinze zecca



Zeckenpinzette  
 Ticks forceps  
 Pinza garrapata  
 Pinze zecca

**KUEHNE**

**13-540-10 - 13-541-10** 10,0 cm, 4"

**13-542-09** 9,0 cm, 3 1/2"

**13-542-12** 12,0 cm, 4 3/4"

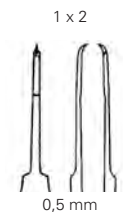
**13-542-14** 14,5 cm, 5 3/4"



**13-600-09**



**13-606-10**



**13-607-10**



**13-614-09**  
**13-614-11**

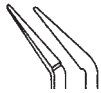
**13-600-09** 9,5 cm, 3 3/4"

**CASTROVIEJO**

**13-606-10 - 13-607-10** 10,0 cm, 4"

**13-614-09** 9,5 cm, 3 3/4"

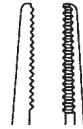
**13-614-11** 11,0 cm, 4 3/8"



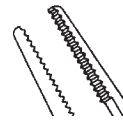
**13-615-07**

**KELMAN-MC PHERSON**

**13-615-07** 10,0 cm, 4"



**13-680-07**



**13-681-07**

**BONN**

**13-680-07 - 13-681-07** 7,5 cm, 3"



**13-682-10**

**TUEBINGEN**

**13-682-10** 10,0 cm, 4"



**13-684-07**

**BONN**

**13-684-07** 7,0 cm, 2 3/4"



**13-686-07**

**BONN**

**13-686-07** 7,0 cm, 2 3/4"



**13-688-10**

**BONN**

**13-688-10** 10,0 cm, 4"



**FIG. 1**  
**13-616-01** 12,0 cm, 4 <sup>3</sup>/<sub>4</sub> "



**FIG. 2**  
**13-616-02** 12,0 cm, 4 <sup>3</sup>/<sub>4</sub> "



**FIG. 3**  
**13-616-03** 12,0 cm, 4 <sup>3</sup>/<sub>4</sub> "



**FIG. 4**  
**13-616-04** 11,0 cm, 4 <sup>3</sup>/<sub>8</sub> "



**FIG. 5**  
**13-616-05** 11,0 cm, 4 <sup>3</sup>/<sub>8</sub> "



**FIG. 5A**  
**13-616-15** 11,0 cm, 4 <sup>3</sup>/<sub>8</sub> "



**FIG. 5**  
**13-616-45** 10,5 cm, 4 <sup>1</sup>/<sub>4</sub> "



**FIG. 5**  
**13-616-90** 10,5 cm, 4 <sup>1</sup>/<sub>4</sub> "  
**13-616-91** 11,0 cm, 4 <sup>3</sup>/<sub>8</sub> "



**FIG. 7**  
**13-617-07** 11,5 cm, 4 <sup>1</sup>/<sub>2</sub> "



**13-617-08** 11,5 cm, 4 <sup>1</sup>/<sub>2</sub> "



**13-617-09** 13,5 cm, 5 <sup>1</sup>/<sub>4</sub> "

# 13

Mikro Instrumente  
Micro Instruments  
Instrumentos de micro  
Strumentario micro









# 14

Pinzetten mit Hartmetalleinlagen

Forceps with tungsten carbide inserts

Pinzas con bocas de carburo tungsteno

Pinze con morsi in carburo di tungsteno





**14-002-14**  
**14-002-16**  
**14-002-20**  
**14-002-25**



**14-004-14**  
**14-004-18**  
**14-004-20**  
**14-004-25**



fein  
 delicate  
 finas  
 fine



**14-044-12**  
**14-044-15**



**STANDARD**

<b>14-002-14</b>	14,0 cm, 5 1/2"
<b>14-002-16</b>	16,0 cm, 6 1/4"
<b>14-002-20</b>	20,0 cm, 8"
<b>14-002-25</b>	25,0 cm, 9 3/4"

**STANDARD**

<b>14-004-14</b>	14,0 cm, 5 1/2"
<b>14-004-18</b>	18,0 cm, 7"
<b>14-004-20</b>	20,0 cm, 8"
<b>14-004-25</b>	25,0 cm, 9 3/4"

**ADSON**

<b>14-044-12</b>	12,0 cm, 4 3/4"
<b>14-044-15</b>	15,0 cm, 6"



**14-046-12**



**14-050-15**



**14-054-12**  
**14-054-15**



**ADSON-MICRO**

<b>14-046-12</b>	12,0 cm, 4 3/4"
------------------	-----------------

**MC INDOE**

<b>14-050-15</b>	15,0 cm, 6"
------------------	-------------

**SEMKEN**

<b>14-054-12</b>	12,0 cm, 4 3/4"
<b>14-054-15</b>	15,0 cm, 6"



**14-061-18**



Dissektor Ende  
 dissector end  
 cabo disecador  
 dissettore

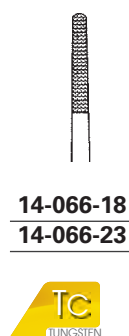
### CUSHING

**14-061-18** 18,0 cm, 7 "



### POTTS-SMITH

<b>14-064-15</b>	15,0 cm, 6 "
<b>14-064-18</b>	18,0 cm, 7 "
<b>14-064-20</b>	20,0 cm, 8 "
<b>14-064-23</b>	23,0 cm, 9 "
<b>14-064-25</b>	25,0 cm, 9 3/4 "



**14-066-18**  
**14-066-23**



Dissektor Ende  
 dissector end  
 cabo disecador  
 dissettore

### CUSHING

<b>14-066-18 - 14-067-18</b>	18,0 cm, 7 "
<b>14-066-23</b>	23,0 cm, 9 "



**14-070-18**



### GERALD

**14-070-18** 18,0 cm, 7 "

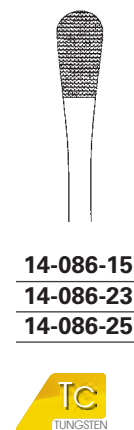


**14-075-18**



### BONNEY

**14-075-18** 18,0 cm, 7 "



**14-086-15**  
**14-086-23**  
**14-086-25**



### WANGENSTEEN

<b>14-086-15</b>	15,0 cm, 6 "
<b>14-086-23</b>	23,0 cm, 9 "
<b>14-086-25</b>	25,0 cm, 9 3/4 "

1 x 2



**STANDARD**

<b>14-102-14</b>	14,0 cm, 5 1/2 "
<b>14-102-16</b>	16,0 cm, 6 1/4 "
<b>14-102-18</b>	18,0 cm, 7 "
<b>14-102-20</b>	20,0 cm, 8 "
<b>14-102-25</b>	25,0 cm, 9 3/4 "

1 x 2



**14-142-12**  
**14-142-15**



**ADSON**

<b>14-142-12</b>	12,0 cm, 4 3/4 "
<b>14-142-15</b>	15,0 cm, 6 "

1 x 2



**14-144-12**  
**14-144-15**



fein  
delicate  
finas  
fine



**ADSON**

<b>14-144-12</b>	12,0 cm, 4 3/4 "
<b>14-144-15</b>	15,0 cm, 6 "

1 x 2



**14-146-12**



**ADSON-MICRO**

<b>14-146-12</b>	12,0 cm, 4 3/4 "
------------------	------------------

1 x 2



**14-152-15**



**GILLIES**

<b>14-152-15</b>	15,0 cm, 6 "
------------------	--------------

1 x 2

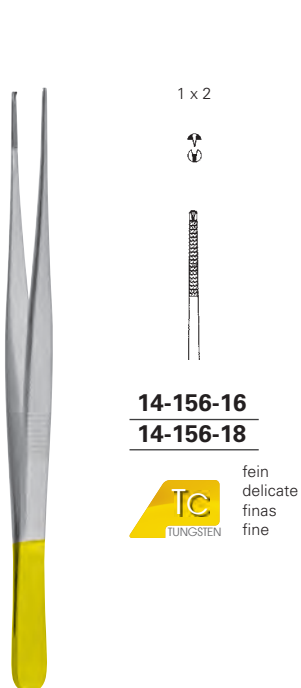


**14-154-15**  
**14-154-18**



**SEMKEN**

<b>14-154-15</b>	15,0 cm, 6 "
<b>14-154-18</b>	18,0 cm, 7 "

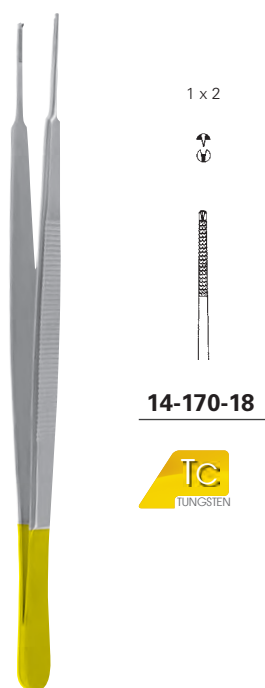


**14-156-16**  
**14-156-18**

**Tc**  
 TUNGSTEN  
 fein  
 delicate  
 finas  
 fine

### SEMKEN

**14-156-16** 16,0 cm, 6 ¼"  
**14-156-18** 18,0 cm, 7"

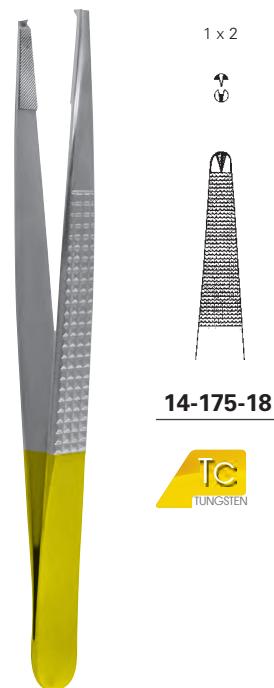


**14-170-18**

**Tc**  
 TUNGSTEN

### GERALD

**14-170-18** 18,0 cm, 7"

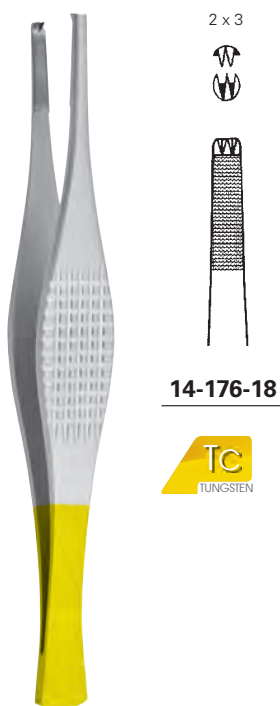


**14-175-18**

**Tc**  
 TUNGSTEN

### BONNEY

**14-175-18** 18,0 cm, 7"



**14-176-18**

**Tc**  
 TUNGSTEN

### FERRIS-SMITH

**14-176-18** 18,0 cm, 7"



**14-190-12**

**Tc**  
 TUNGSTEN

### ADSON-BROWN

**14-190-12 - 14-191-12** 12,0 cm, 4 ¾"



**14-191-12**

**Tc**  
 TUNGSTEN



**14-191-15**

**Tc**  
 TUNGSTEN

### ADSON-BROWN

**14-191-15** 15,0 cm, 6"



**14-200-20**

Nähtpinzette  
 Suture forceps  
 Pinza para sutura  
 Pinze per sutura



**14-200-20** 20,0 cm, 8"



2,0 mm

**14-208-16**  
**14-208-20**  
**14-208-24**



**DE BAKEY**

**14-208-16** 16,0 cm, 6 ¼"  
**14-208-20** 20,0 cm, 8"  
**14-208-24** 24,0 cm, 9 ½"



1,5 mm

**14-210-16**  
**14-210-20**  
**14-210-24**



**DE BAKEY**

**14-210-16** 16,0 cm, 6 ¼"  
**14-210-20** 20,0 cm, 8"  
**14-210-24** 24,0 cm, 9 ½"



# 15

Arterienklemmen

Artery forceps, Haemostatic forceps

Pinzas haemostaticas

Pinze emostatiche





**15-000-14**



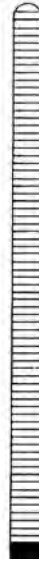
**15-000-16**



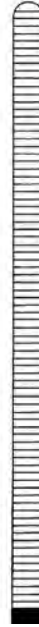
**15-000-18**



**15-000-20**



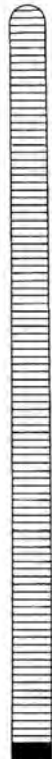
**15-000-22**



**15-000-24**



**15-000-26**

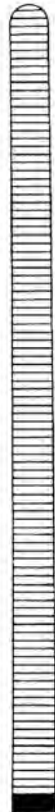


**15-000-28**



**PEAN**

<b>15-000-14</b>	14,0 cm, 5 1/2 "
<b>15-000-16</b>	16,0 cm, 6 1/4 "
<b>15-000-18</b>	18,0 cm, 7 "
<b>15-000-20</b>	20,0 cm, 8 "
<b>15-000-22</b>	22,0 cm, 8 3/4 "
<b>15-000-24</b>	24,0 cm, 9 1/2 "
<b>15-000-26</b>	26,0 cm, 10 1/4 "
<b>15-000-28</b>	28,0 cm, 11 "
<b>15-000-30</b>	30,0 cm, 11 3/4 "
<b>15-000-36</b>	36,0 cm, 14 1/4 "
<b>15-000-40</b>	40,0 cm, 16 "



**15-000-30**

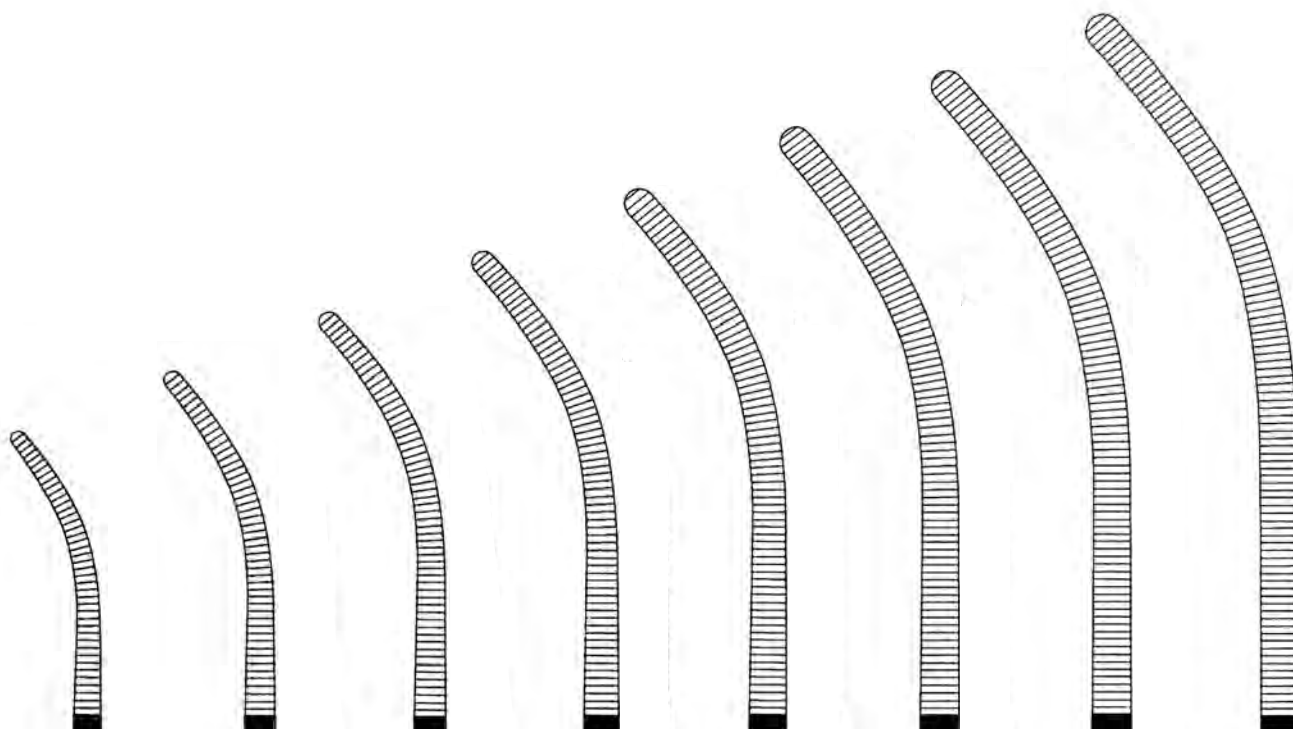


**15-000-36**



**15-000-40**





**15-001-14**

**15-001-16**

**15-001-18**

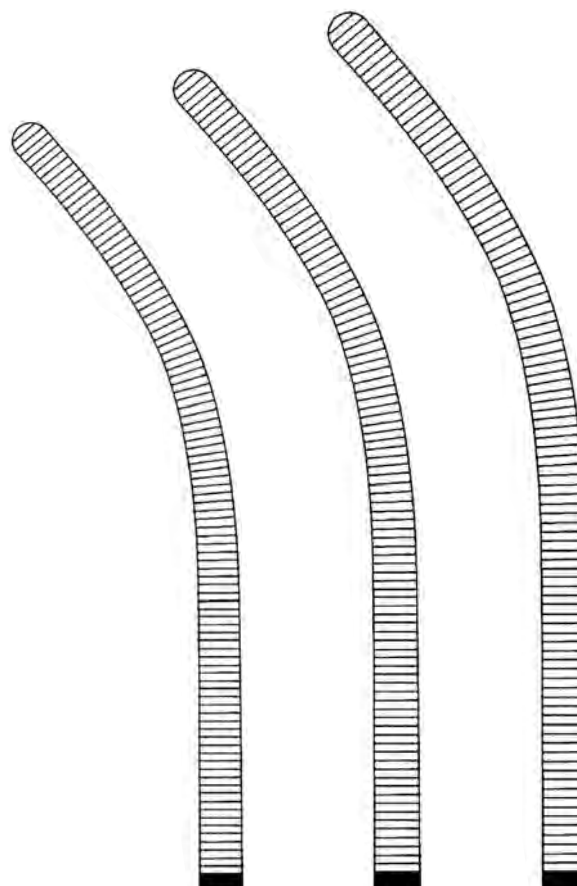
**15-001-20**

**15-001-22**

**15-001-24**

**15-001-26**

**15-001-28**



**15-001-30**

**15-001-36**

**15-001-40**

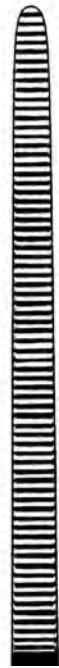


**PEAN**

<b>15-001-14</b>	14,0 cm, 5 ½"
<b>15-001-16</b>	16,0 cm, 6 ¼"
<b>15-001-18</b>	18,0 cm, 7"
<b>15-001-20</b>	20,0 cm, 8"
<b>15-001-22</b>	22,0 cm, 8 ¾"
<b>15-001-24</b>	24,0 cm, 9 ½"
<b>15-001-26</b>	26,0 cm, 10 ¼"
<b>15-001-28</b>	28,0 cm, 11"
<b>15-001-30</b>	30,0 cm, 11 ¾"
<b>15-001-36</b>	36,0 cm, 14 ¼"
<b>15-001-40</b>	40,0 cm, 16"



**15-002-24**



**15-003-24**



**15-006-12**

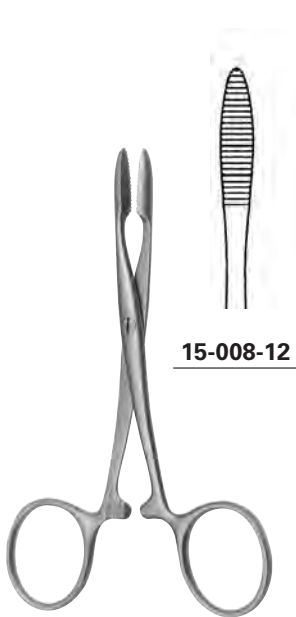


**PEAN**

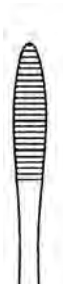
**15-002-24 - 15-003-24** 24,0 cm, 9 ½"

**PEAN**

**15-006-12** 12,5 cm, 5"



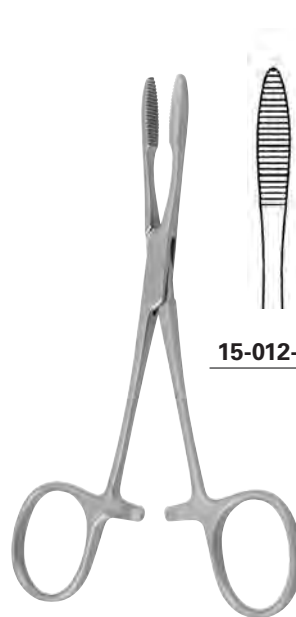
**15-008-12**



**15-008-16**



**15-008-18**



**15-012-12**



**15-012-14**



**15-012-16**

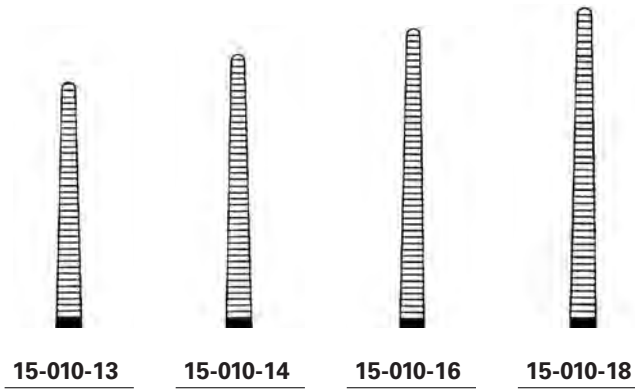


**PEAN**

**15-008-12** 12,5 cm, 5"  
**15-008-16** 16,5 cm, 6 ½"  
**15-008-18** 18,5 cm, 7 ¼"

**PEAN**

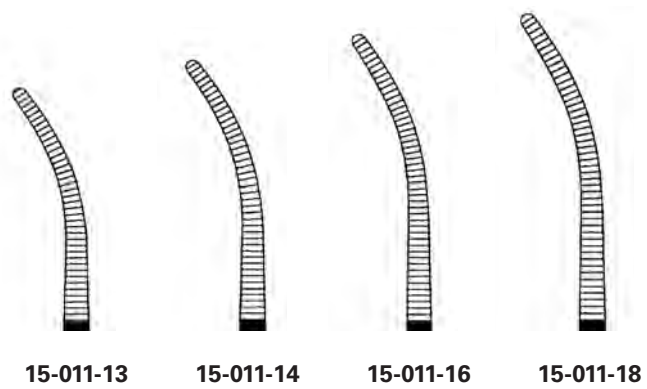
**15-012-12** 12,5 cm, 5"  
**15-012-14** 14,0 cm, 5 ½"  
**15-012-16** 16,0 cm, 6 ¼"



fein  
 delicate  
 fino  
 fine

### PEAN

<b>15-010-13</b>	13,0 cm, 5 1/8 "
<b>15-010-14</b>	14,0 cm, 5 1/2 "
<b>15-010-16</b>	16,0 cm, 6 1/4 "
<b>15-010-18</b>	18,0 cm, 7 "



fein  
 delicate  
 fino  
 fine

### PEAN

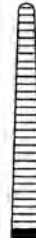
<b>15-011-13</b>	13,0 cm, 5 1/8 "
<b>15-011-14</b>	14,0 cm, 5 1/2 "
<b>15-011-16</b>	16,0 cm, 6 1/4 "
<b>15-011-18</b>	18,0 cm, 7 "



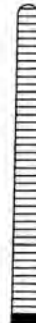
**15-014-13**



**15-014-14**



**15-014-15**



**15-014-18**



**15-014-20**

**SPENCER-WELLS**

<b>15-014-13</b>	13,0 cm, 5 1/8"
<b>15-014-14</b>	14,0 cm, 5 1/2"
<b>15-014-15</b>	15,0 cm, 6"
<b>15-014-18</b>	18,0 cm, 7"
<b>15-014-20</b>	20,0 cm, 8"



**15-015-13**



**15-015-14**



**15-015-15**



**15-015-18**



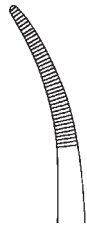
**15-015-20**



**15-015-23**

**SPENCER-WELLS**

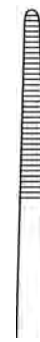
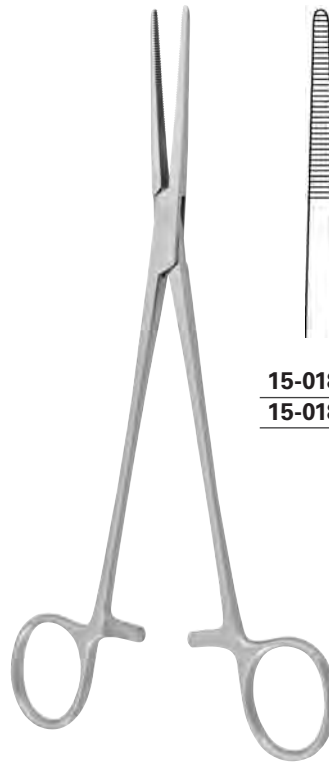
<b>15-015-13</b>	13,0 cm, 5 1/8"
<b>15-015-14</b>	14,0 cm, 5 1/2"
<b>15-015-15</b>	15,0 cm, 6"
<b>15-015-18</b>	18,0 cm, 7"
<b>15-015-20</b>	20,0 cm, 8"
<b>15-015-23</b>	23,0 cm, 9"



15-017-18

**NISSEN**

15-017-18 18,5 cm, 7 ¼"



15-018-21  
15-018-26

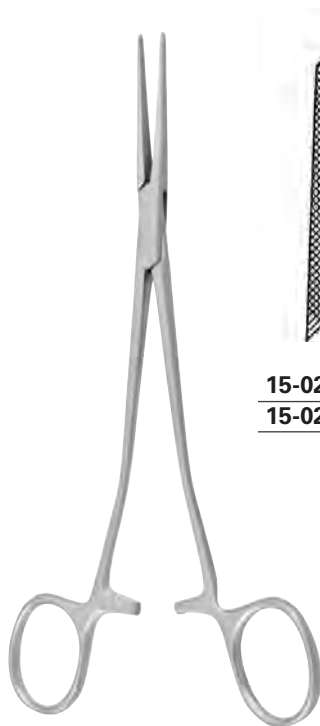


15-019-21  
15-019-26

**TOENNIS**

15-018-21 - 15-019-21 21,0 cm, 8 ¼"

15-018-26 - 15-019-26 26,0 cm, 10 ¼"



15-020-01  
15-020-02

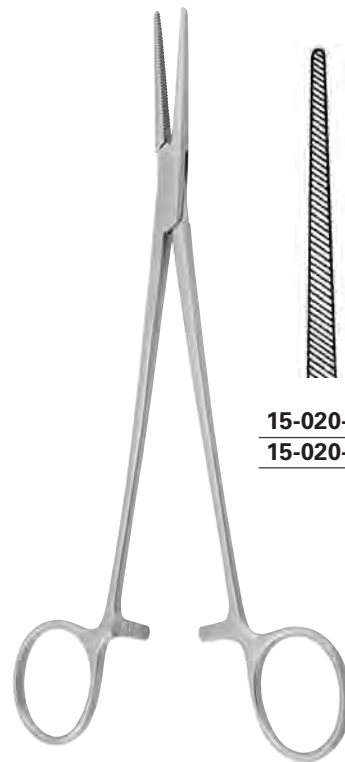


15-020-03  
15-020-04

**BENGOLEA (MOD. FRENCH)**

15-020-01 - 15-020-03 18,0 cm, 7"

15-020-02 - 15-020-04 23,0 cm, 9"



15-020-20  
15-020-26



15-021-20  
15-021-26

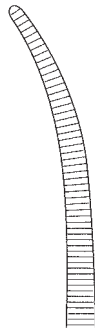
**BENGOLEA**

15-020-20 - 15-021-20 20,0 cm, 8"

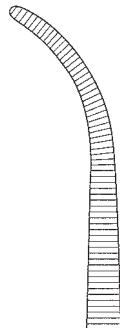
15-020-26 - 15-021-26 26,0 cm, 10 ¼"



**15-022-20**



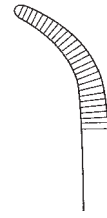
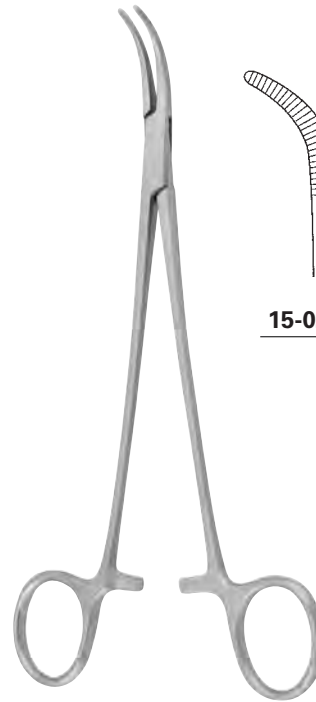
**15-023-20**



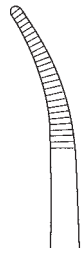
**15-025-20**

**HEISS**

**15-022-20 - 15-025-20** 20,0 cm, 8"



**15-029-18**

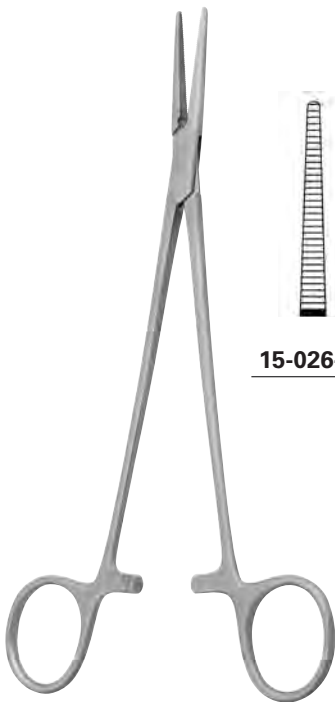


**15-029-19**

**SCHNIDT**

**15-029-18** 18,0 cm, 7"

**15-029-19** 19,0 cm, 7 1/2"



**15-026-18**



**15-026-21**



**15-027-18**

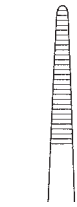


**15-027-21**

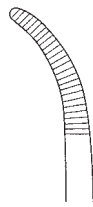
**HALSTED-MOSQUITO**

**15-026-18 - 15-027-18** 18,0 cm, 7"

**15-026-21 - 15-027-21** 21,0 cm, 8 1/4"



**15-030-18**



**15-031-19**



**15-033-14**

### ADSON

**15-030-18** 18,5 cm, 7 ¼"

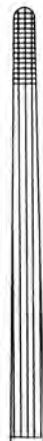
**15-031-19** 19,0 cm, 7 ½"

### MICRO-ADSON

**15-033-14** 14,0 cm, 5 ½"



**15-034-16**



**15-034-20**



**15-035-16**

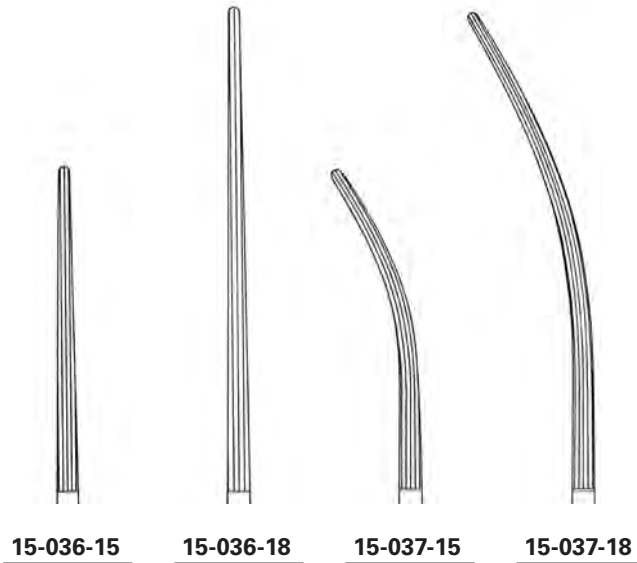


**15-035-20**

### ROCHESTER-CARMALT

**15-034-16 - 15-035-16** 16,0 cm, 6 ¼"

**15-034-20 - 15-035-20** 20,0 cm, 8"



**15-036-15**

**15-036-18**

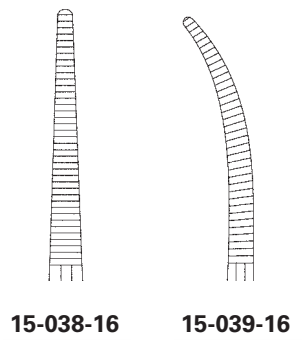
**15-037-15**

**15-037-18**

**BAINBRIDGE**

**15-036-15 - 15-037-15** 15,0 cm, 6 "

**15-036-18 - 15-037-18** 18,0 cm, 7 "

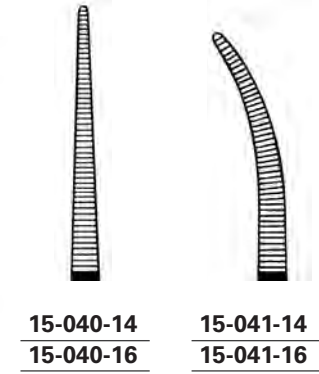


**15-038-16**

**15-039-16**

**CRILE-RANKIN**

**15-038-16 - 15-039-16** 16,0 cm, 6 ¼ "



**15-040-14**

**15-040-16**

**15-041-14**

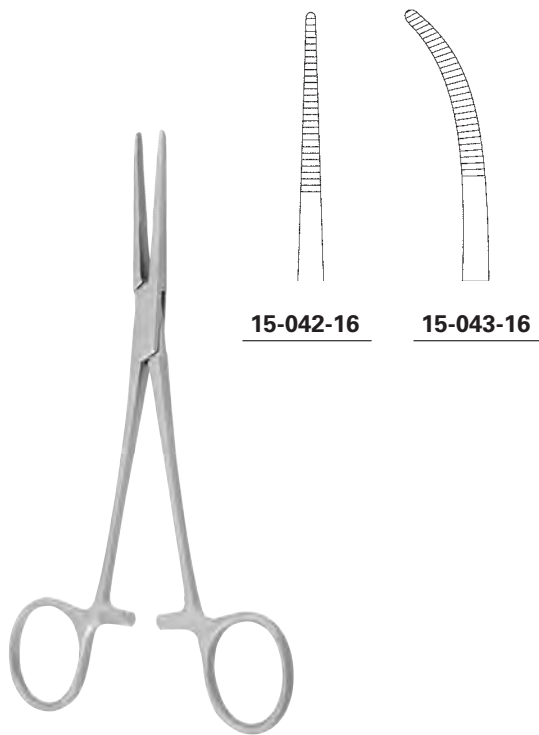
**15-041-16**

**COLLER**

**15-040-14 - 15-041-14** 14,0 cm, 5 ½ "

**15-040-16 - 15-041-16** 16,0 cm, 6 ¼ "





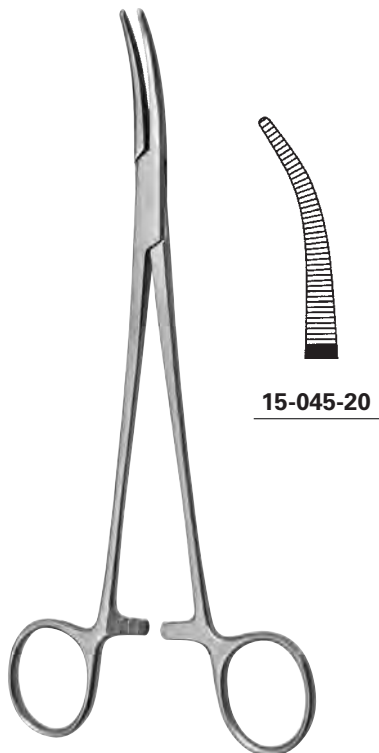
### KELLY-RANKIN

15-042-16 - 15-043-16 16,0 cm, 6 ¼"



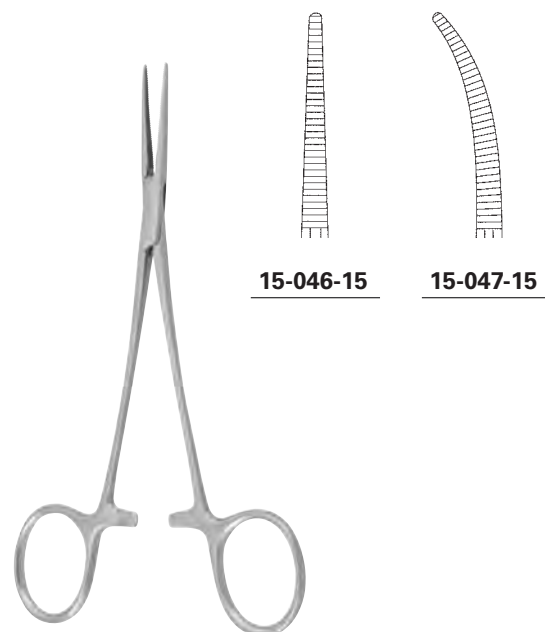
### DIXON-LOVELACE

15-044-15 15,0 cm, 6"



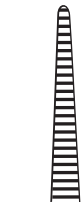
### FUCHSIG

15-045-20 20,0 cm, 8"



### LERICHE

15-046-15 - 15-047-15 15,0 cm, 6"



**15-048-13**



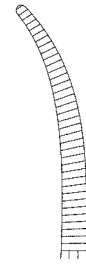
**15-049-13**

**BABY-CRILE**

**15-048-13 - 15-049-13** 14,0 cm, 5 1/2"



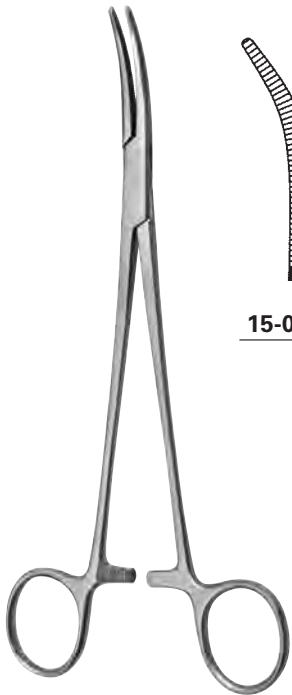
**15-048-14**



**15-049-14**

**CRILE**

**15-048-14 - 15-049-14** 14,0 cm, 5 1/2"



**15-049-18**

**CRILE (FRASER-KELLY)**

**15-049-18** 18,0 cm, 7"



**15-050-10**

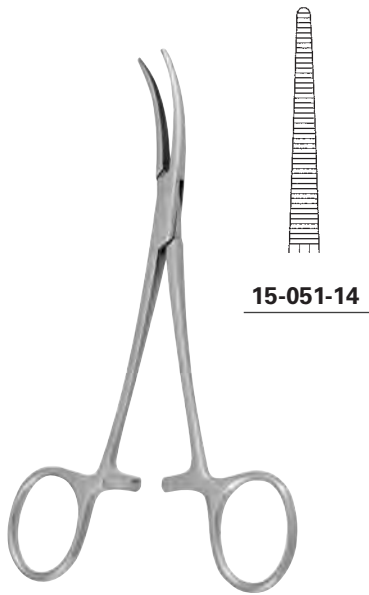
**15-050-10** 10,0 cm, 4"



**15-051-12**

**MOSQUITO-DANDY**

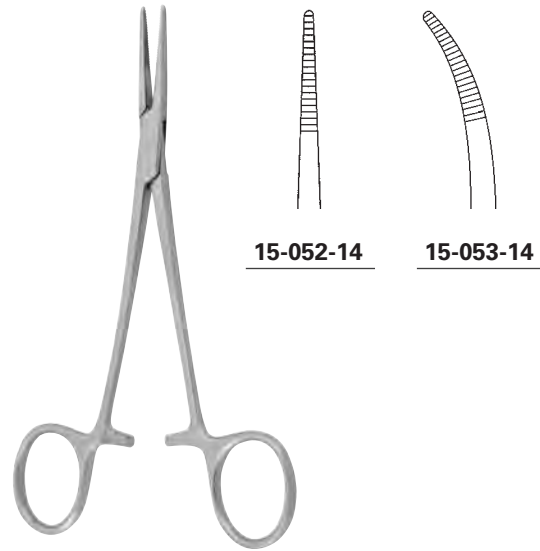
**15-051-12** 12,0 cm, 4 3/4"



**15-051-14**

**DANDY**

**15-051-14** 14,0 cm, 5 ½"

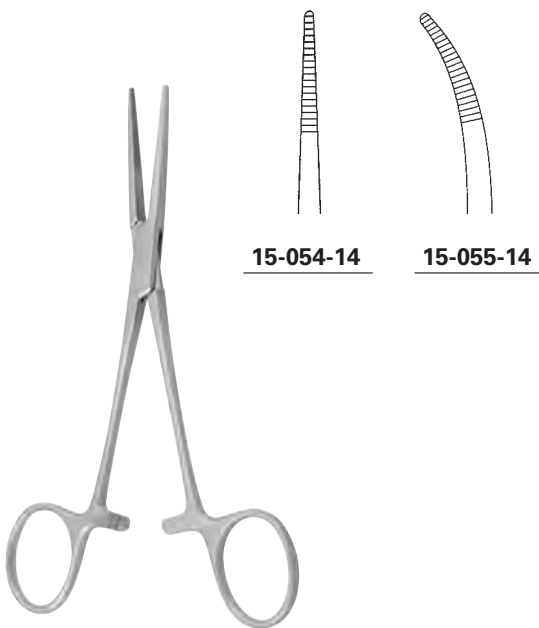


**15-052-14**

**15-053-14**

**KELLY**

**15-052-14 - 15-053-14** 14,0 cm, 5 ½"

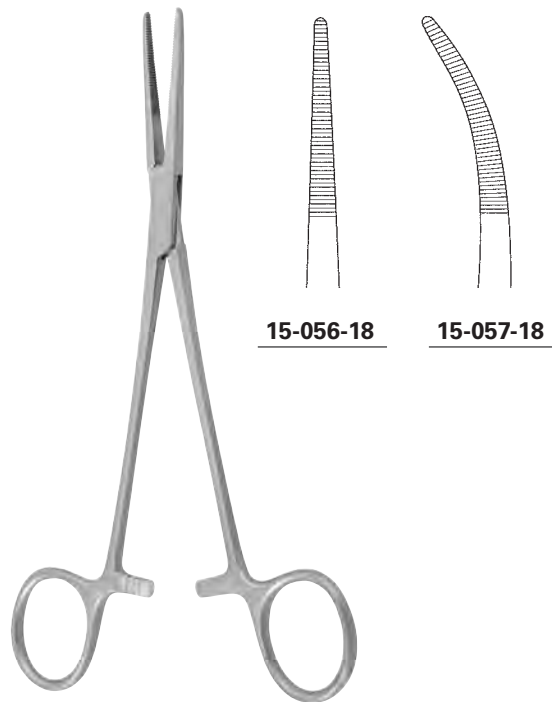


**15-054-14**

**15-055-14**

**PROVIDENCE-HOSPITAL**

**15-054-14 - 15-055-14** 14,0 cm, 5 ½"



**15-056-18**

**15-057-18**

**BIRKETT**

**15-056-18 - 15-057-18** 18,5 cm, 7 ¼"



**15-060-12**



**15-060-14**



**15-061-12**

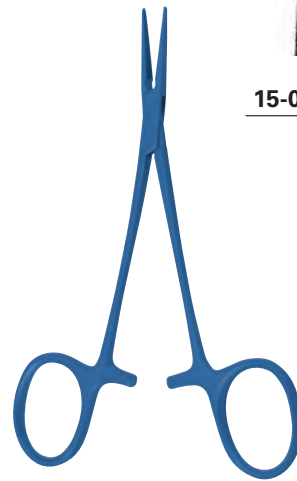


**15-061-14**

**HALSTED-MOSQUITO**

**15-060-12 - 15-061-12** 12,5 cm, 5"

**15-060-14 - 15-061-14** 14,0 cm, 5 1/2"



**15-060-12 T**



**15-061-12 T**



**HALSTED-MOSQUITO**

**15-060-12 T - 15-061-12 T** 12,5 cm, 5"



**15-062-10**



**15-062-12**



**15-063-10**



**15-063-12**

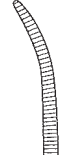
**MICRO-MOSQUITO**

**15-062-10 - 15-063-10** 10,0 cm, 4"

**15-062-12 - 15-063-12** 12,5 cm, 5"



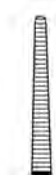
**15-064-10**



**15-065-10**

**HARTMANN**

**15-064-10 - 15-065-10** 10,0 cm, 4"



**15-066-08**



**CARREL**

**15-066-08** 8,0 cm, 3 1/8"



**15-067-12**

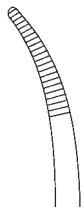


**BABY-MOSQUITO**

**15-067-12** 12,0 cm, 4 3/4"



**15-068-14**



**15-069-14**



**CAIRNS**

**15-068-14 - 15-069-14** 14,0 cm, 5 1/2"



**15-072-13**



**KROENLEIN**

**15-072-13** 13,0 cm, 5 1/8"



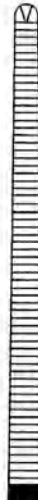
15-100-14



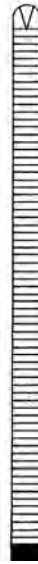
15-100-15



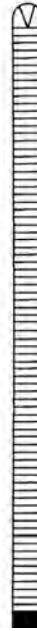
15-100-16



15-100-18



15-100-20



15-100-22



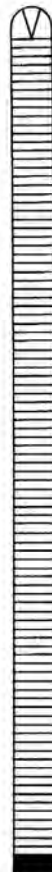
15-100-24



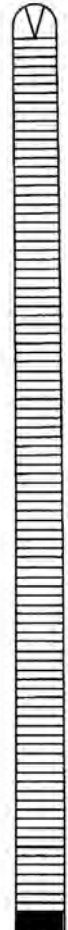
15-100-26



15-100-30



15-100-36

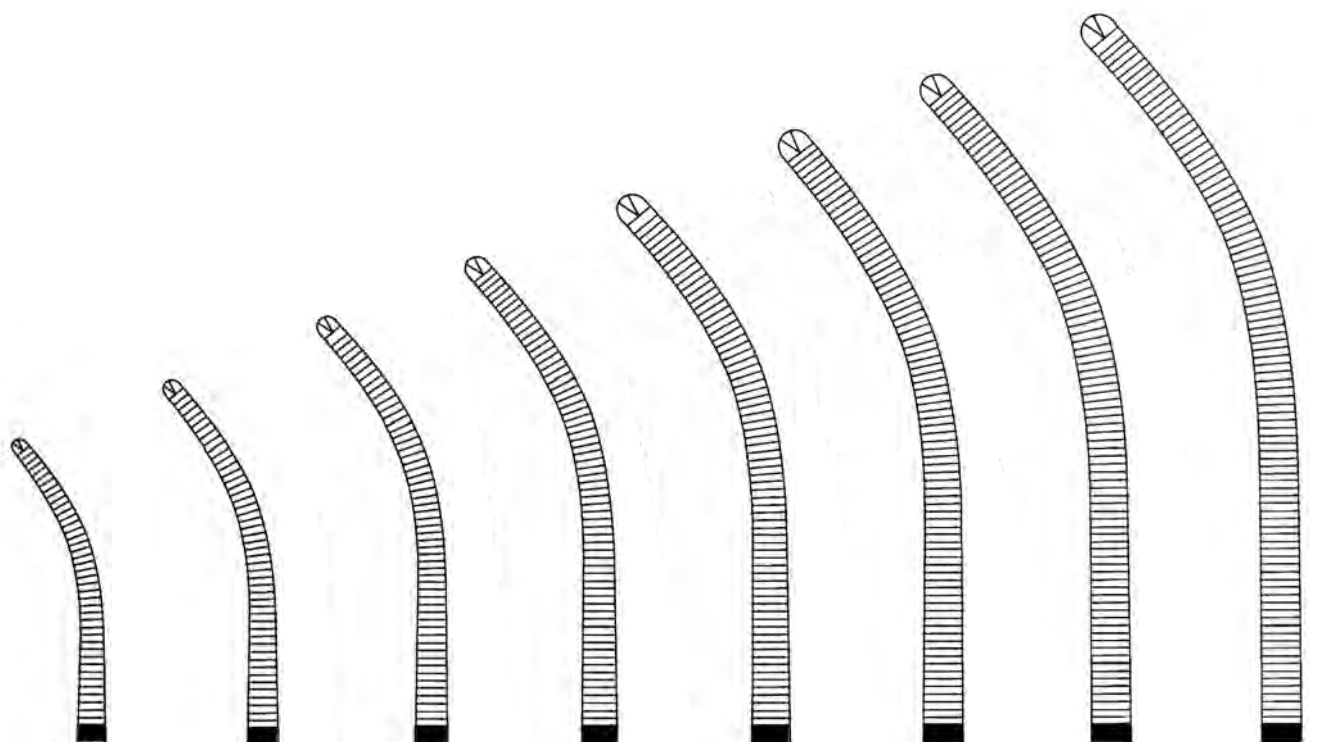


15-100-40



**OCHSNER-KOCHER**

15-100-14	14,0 cm, 5 1/2 "
15-100-15	15,0 cm, 6 "
15-100-16	16,0 cm, 6 1/4 "
15-100-18	18,0 cm, 7 "
15-100-20	20,0 cm, 8 "
15-100-22	22,0 cm, 8 3/4 "
15-100-24	24,0 cm, 9 1/2 "
15-100-26	26,0 cm, 10 1/4 "
15-100-30	30,0 cm, 11 3/4 "
15-100-36	36,0 cm, 14 1/4 "
15-100-40	40,0 cm, 16 "



15-101-14

15-101-15

15-101-16

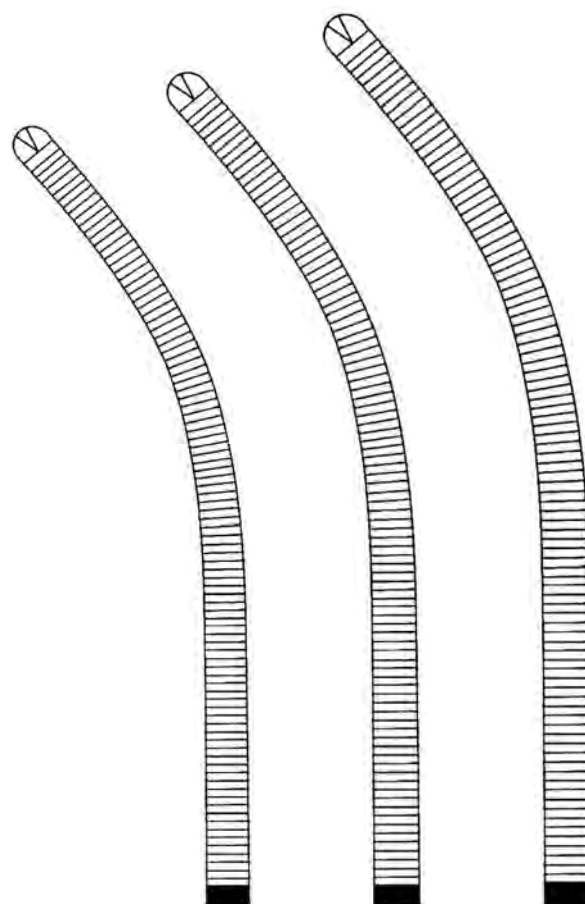
15-101-18

15-101-20

15-101-22

15-101-24

15-101-26



15-101-30

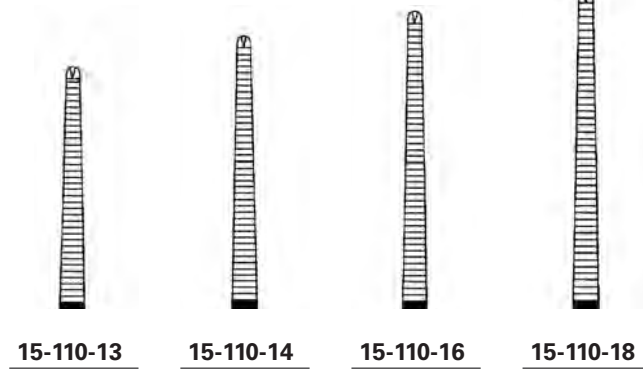
15-101-36

15-101-40



### OCHSNER-KOCHER

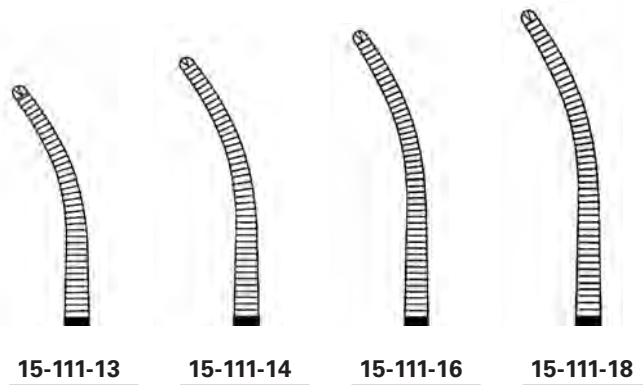
15-101-14	14,0 cm, 5 1/2"
15-101-15	15,0 cm, 6"
15-101-16	16,0 cm, 6 1/4"
15-101-18	18,0 cm, 7"
15-101-20	20,0 cm, 8"
15-101-22	22,0 cm, 8 3/4"
15-101-24	24,0 cm, 9 1/2"
15-101-26	26,0 cm, 10 1/4"
15-101-30	30,0 cm, 11 3/4"
15-101-36	36,0 cm, 14 1/4"
15-101-40	40,0 cm, 16"



fein  
delicate  
fino  
fine

### KOCHER

<b>15-110-13</b>	13,0 cm, 5 1/8"
<b>15-110-14</b>	14,0 cm, 5 1/2"
<b>15-110-16</b>	16,0 cm, 6 1/4"
<b>15-110-18</b>	18,0 cm, 7"

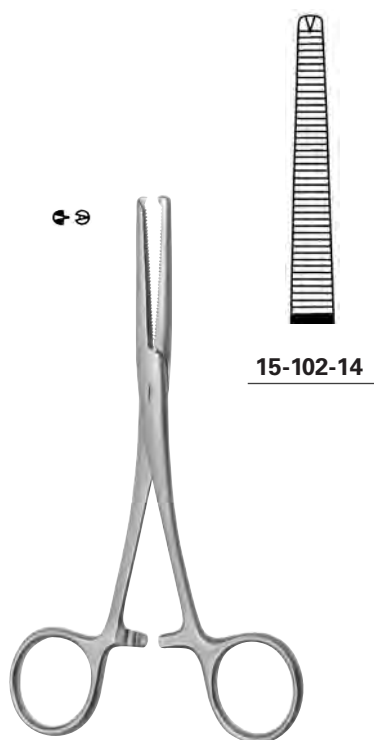


fein  
delicate  
fino  
fine

### KOCHER

<b>15-111-13</b>	13,0 cm, 5 1/8"
<b>15-111-14</b>	14,0 cm, 5 1/2"
<b>15-111-16</b>	16,0 cm, 6 1/4"
<b>15-111-18</b>	18,0 cm, 7"

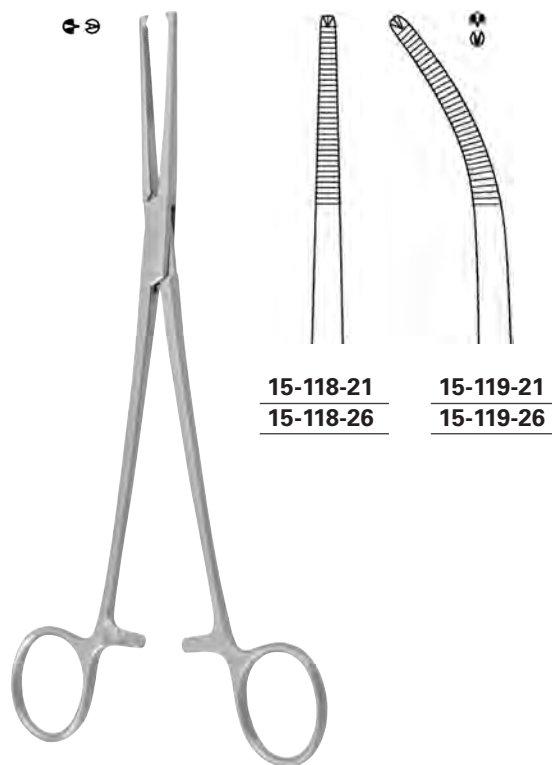




**15-102-14**

**KOCHER**

**15-102-14** 14,0 cm, 5 ½"

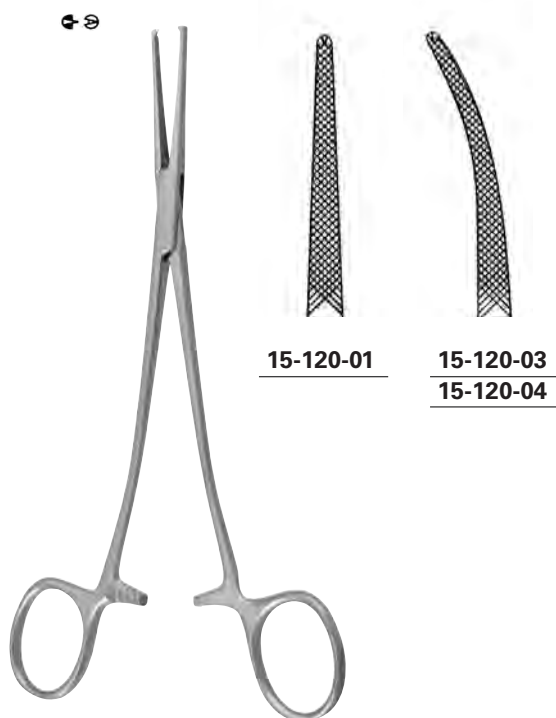


**15-118-21**  
**15-118-26**

**15-119-21**  
**15-119-26**

**TOENNIS**

**15-118-21 - 15-119-21** 21,0 cm, 8 ¼"  
**15-118-26 - 15-119-26** 26,0 cm, 10 ¼"

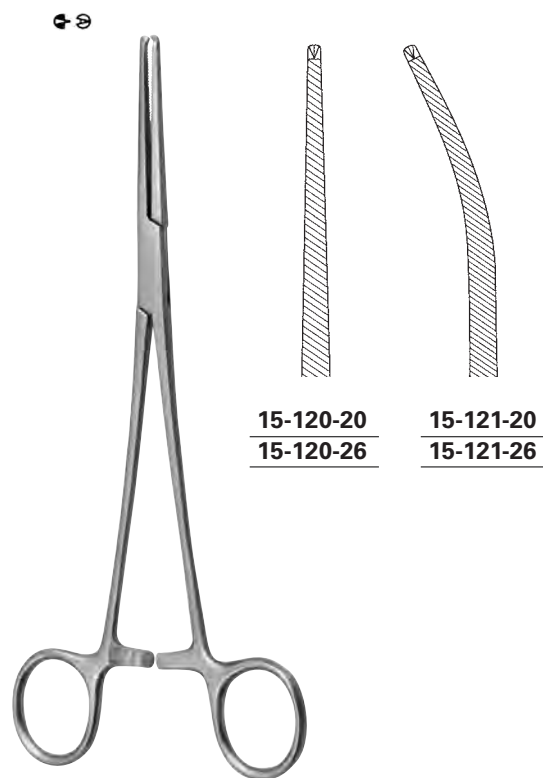


**15-120-01**

**15-120-03**  
**15-120-04**

**BENGOLEA (MOD. FRENCH)**

**15-120-01 - 15-120-03** 18,0 cm, 7"  
**15-120-04** 23,0 cm, 9"

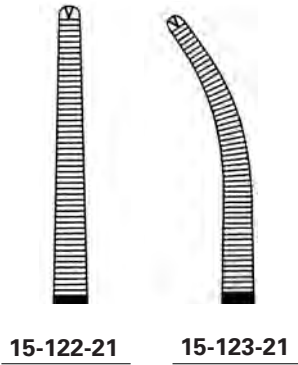


**15-120-20**  
**15-120-26**

**15-121-20**  
**15-121-26**

**BENGOLEA**

**15-120-20 - 15-121-20** 20,0 cm, 8"  
**15-120-26 - 15-121-26** 26,0 cm, 10 ¼"

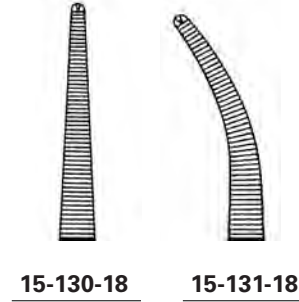
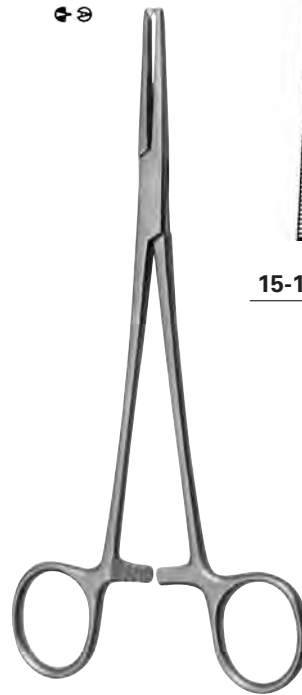


**15-122-21**

**15-123-21**

**HEISS**

**15-122-21 - 15-123-21** 21,0 cm, 8 ¼"

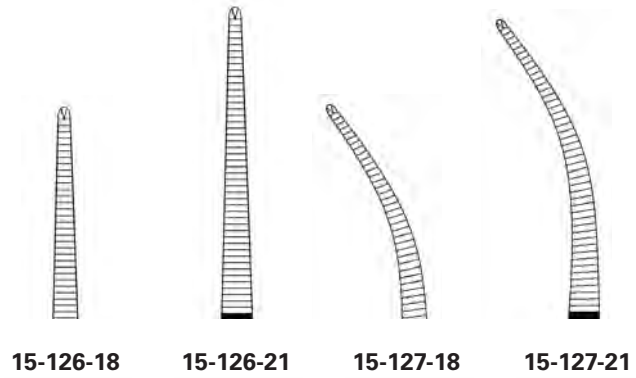
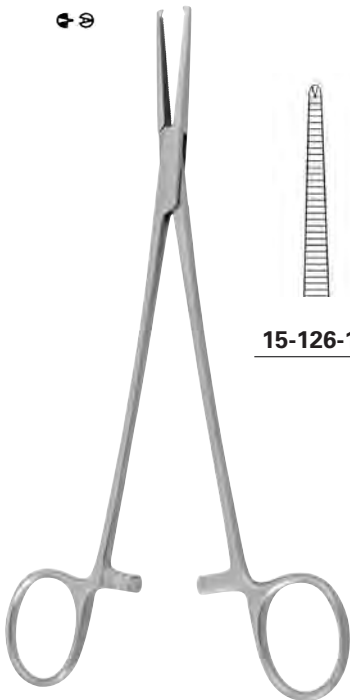


**15-130-18**

**15-131-18**

**ADSON**

**15-130-18 - 15-131-18** 18,0 cm, 7"



**15-126-18**

**15-126-21**

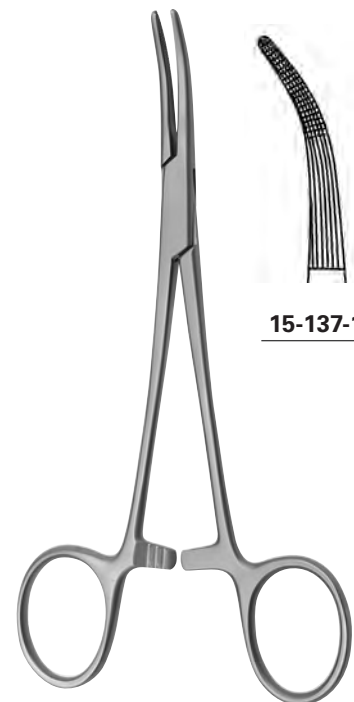
**15-127-18**

**15-127-21**

**HALSTED-MOSQUITO**

**15-126-18 - 15-127-18** 18,0 cm, 7"

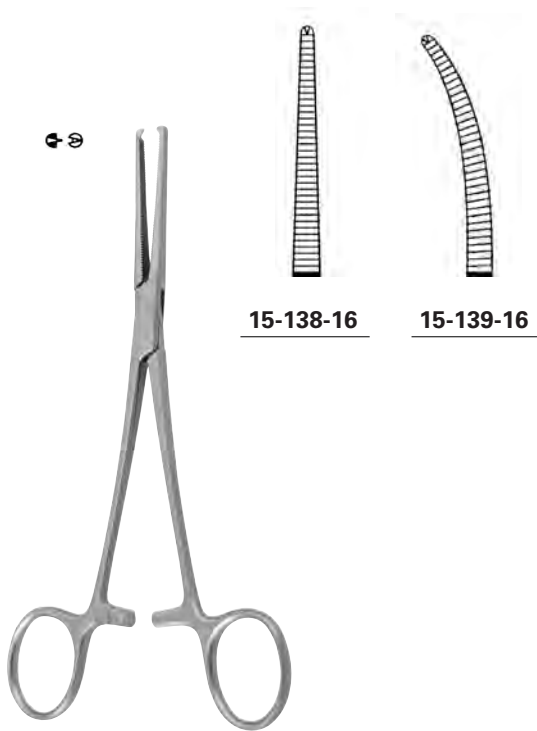
**15-126-21 - 15-127-21** 21,0 cm, 8 ¼"



**15-137-18**

**GREY-TURNER**

**15-137-18** 18,0 cm, 7"

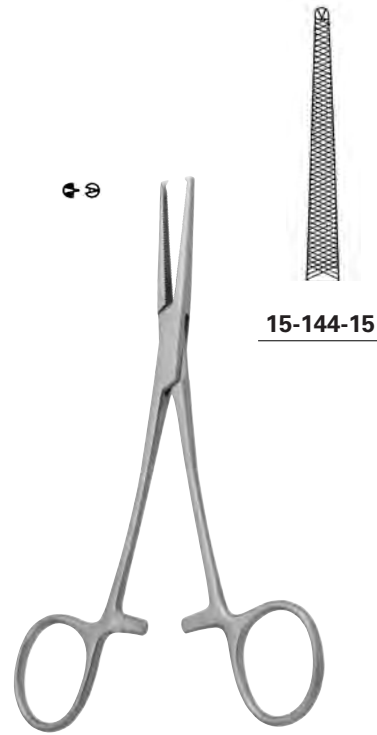


**15-138-16**

**15-139-16**

**CRILE-RANKIN**

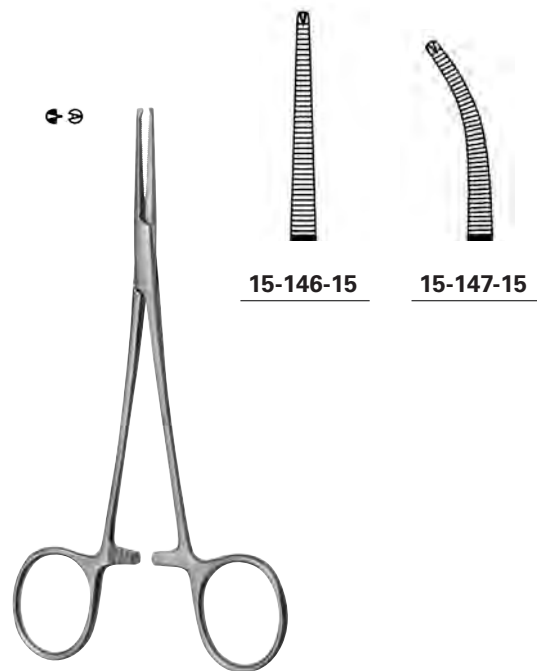
**15-138-16 - 15-139-16** 16,0 cm, 6 ¼"



**15-144-15**

**DIXON-LOVELACE**

**15-144-15** 15,0 cm, 6"

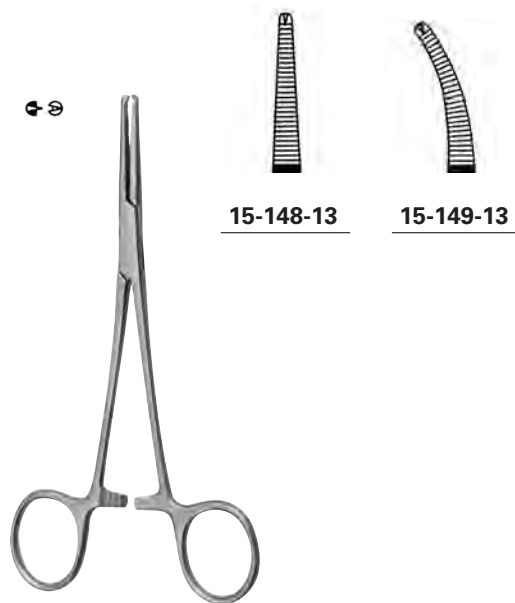


**15-146-15**

**15-147-15**

**LERICHE**

**15-146-15 - 15-147-15** 15,0 cm, 6"

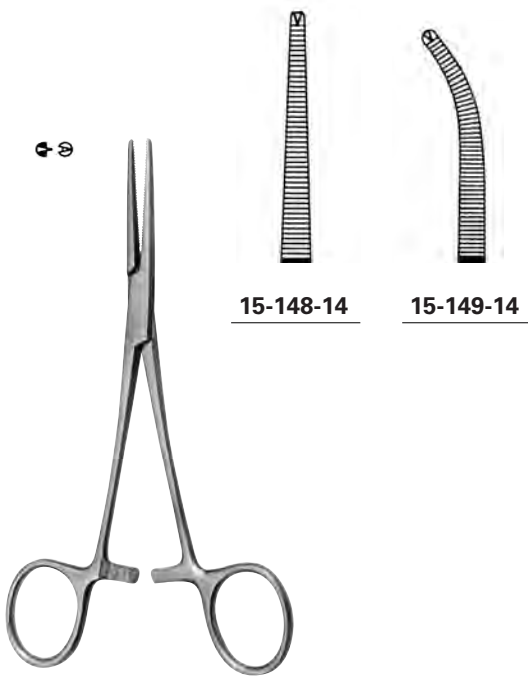


**15-148-13**

**15-149-13**

**BABY-CRILE**

**15-148-13 - 15-149-13** 14,0 cm, 5 ½"

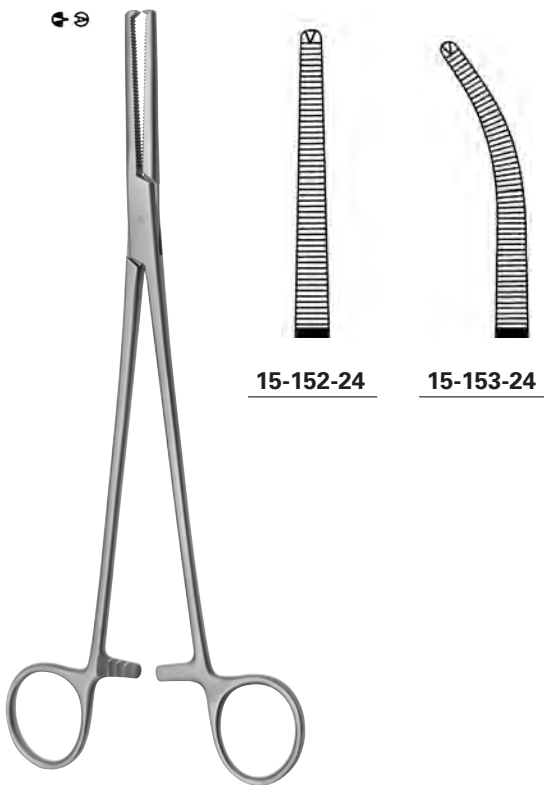


**CRILE**

**15-148-14 - 15-149-14** 14,0 cm, 5 ½"

**DANDY**

**15-151-14** 14,0 cm, 5 ½"

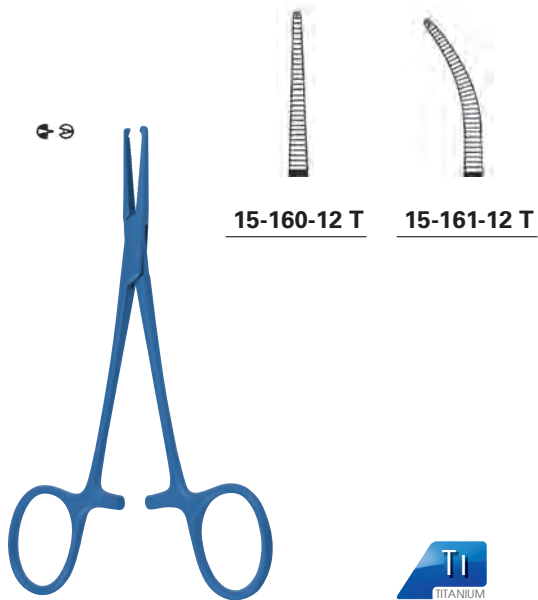


**HOLZBACH**

**15-152-24 - 15-153-24** 24,0 cm, 9 ½"

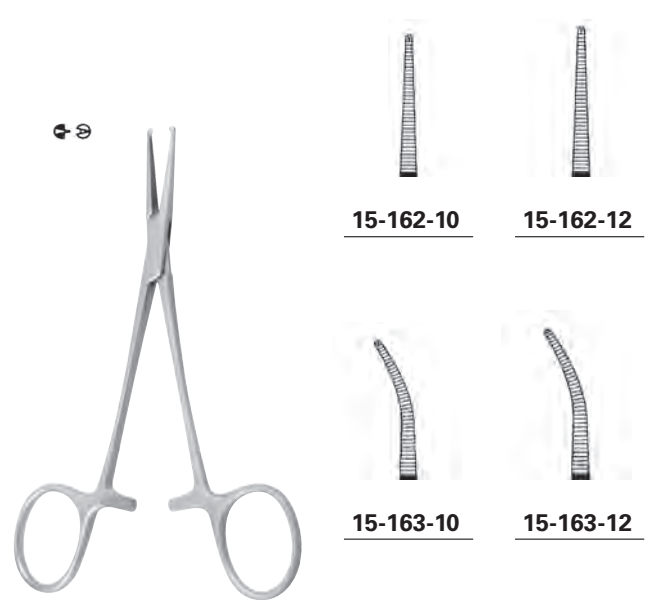
**HALSTED-MOSQUITO**

**15-160-12 - 15-161-12** 12,5 cm, 5"  
**15-160-14 - 15-161-14** 14,0 cm, 5 ½"



### HALSTED-MOSQUITO

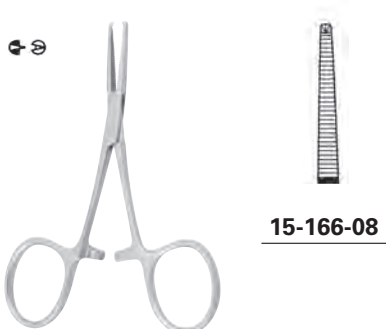
15-160-12 T - 15-161-12 T 12,5 cm, 5 "



### MICRO-MOSQUITO

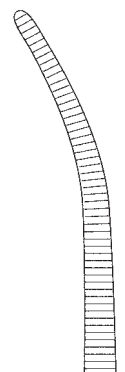
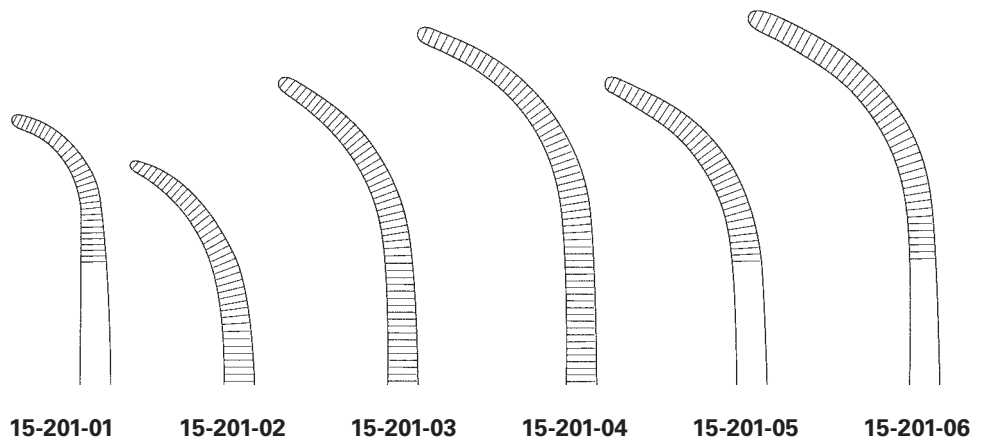
15-162-10 - 15-163-10 10,0 cm, 4 "

15-162-12 - 15-163-12 12,5 cm, 5 "



### TERRIER

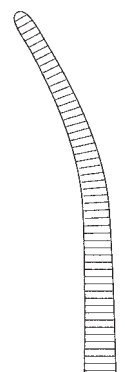
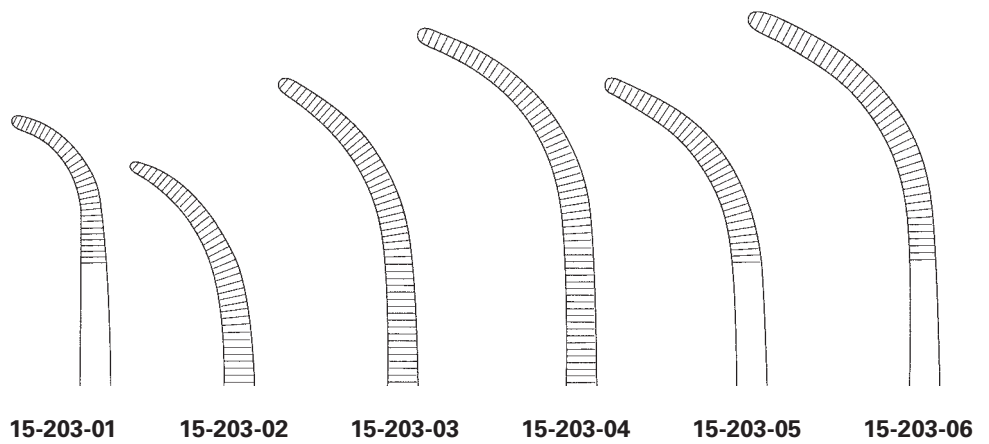
15-166-08 8,0 cm, 3 1/8 "



**OVERHOLT-GEISENDOERFER**

15-201-01 - 15-201-07 21,0 cm, 8 ¼"

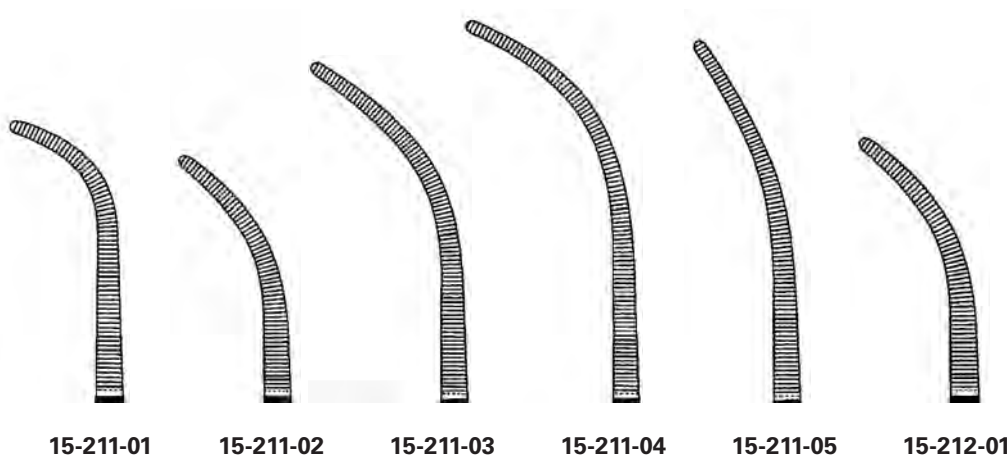
15-201-07



**OVERHOLT-GEISENDOERFER**

15-203-01 - 15-203-07 27,0 cm, 10 ¾"

15-203-07



15-211-01

15-211-02

15-211-03

15-211-04

15-211-05

15-212-01

### OVERHOLT

15-211-01 - 15-211-02 21,0 cm, 8 1/4"

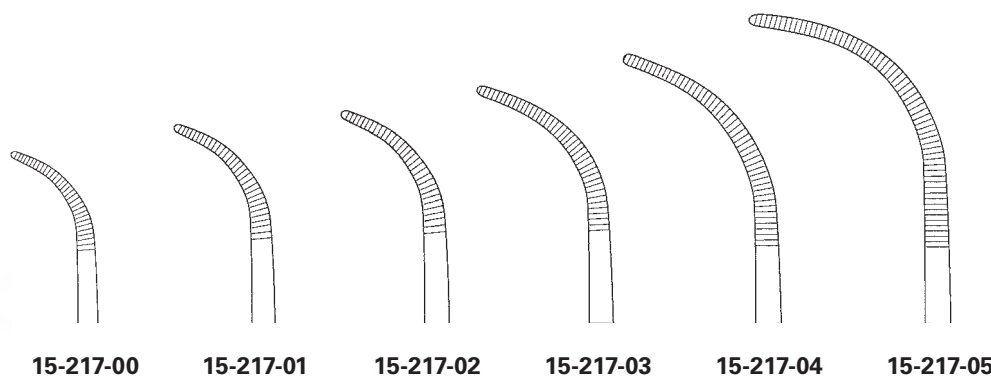
15-211-03 - 15-211-05 22,0 cm, 8 3/4"

15-212-01 26,0 cm, 10 1/4"

15-212-04 27,0 cm, 10 3/4"



15-212-04



15-217-00

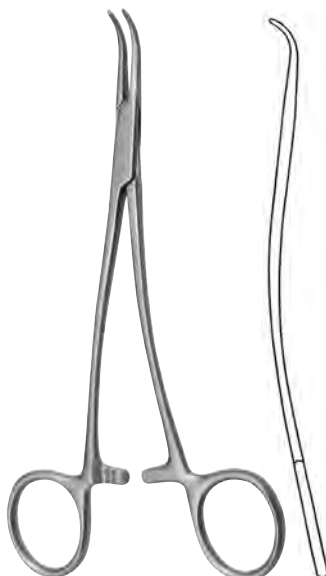
15-217-01

15-217-02

15-217-03

15-217-04

15-217-05



### OVERHOLT-S

15-217-00 15,0 cm, 6"

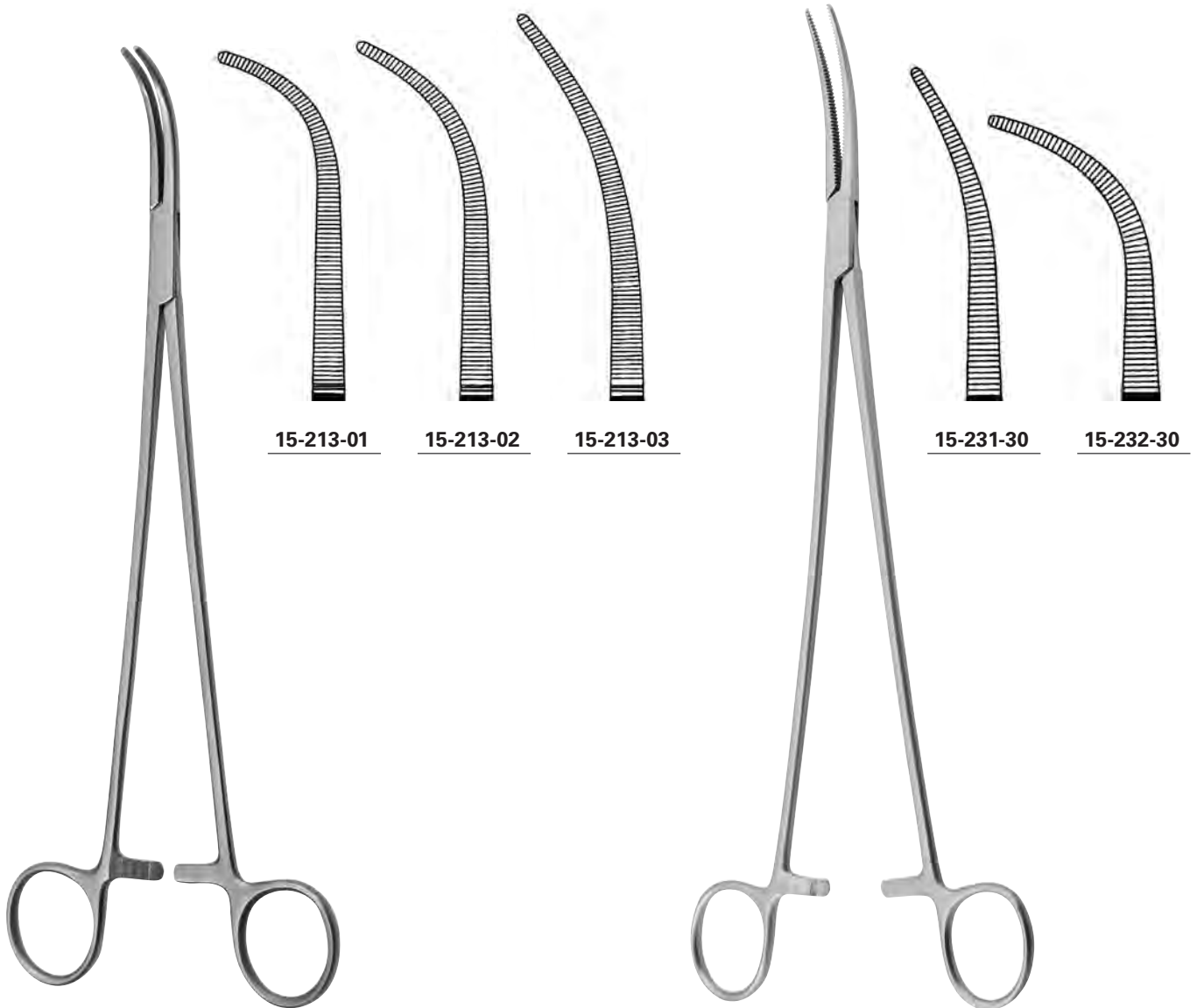
15-217-01 18,5 cm, 7 1/4"

15-217-02 20,5 cm, 8"

15-217-03 21,0 cm, 8 1/4"

15-217-04 21,5 cm, 8 1/2"

15-217-05 24,0 cm, 9 1/2"



15-213-01

15-213-02

15-213-03

15-231-30

15-232-30

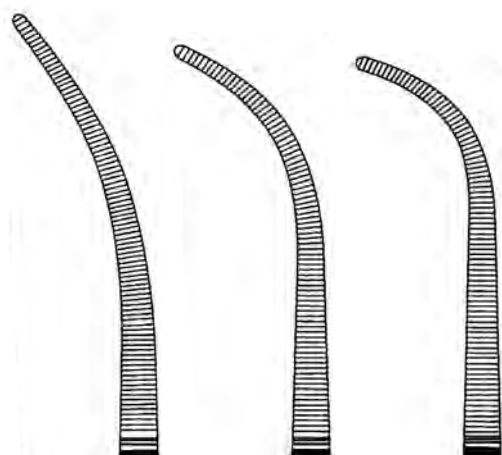
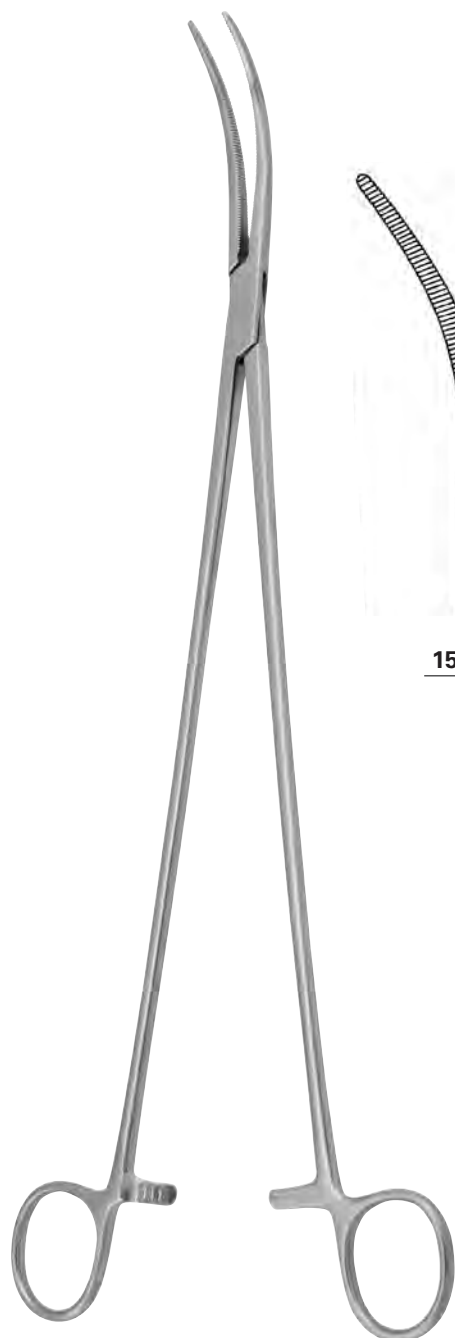
**OVERHOLT**

15-213-01 - 15-231-02 29,0 cm, 11 1/4"  
15-213-03 30,0 cm, 11 3/4"

**ZENKER**

15-231-30 - 15-232-30 30,0 cm, 11 3/4"





15-231-35

15-232-35

15-232-36

## ZENKER

15-231-35 - 15-232-36 35,0 cm, 13<sup>3</sup>/<sub>4</sub>"



**15-233-28**

**LAWRENCE**

**15-233-28** 28,0 cm, 11 "



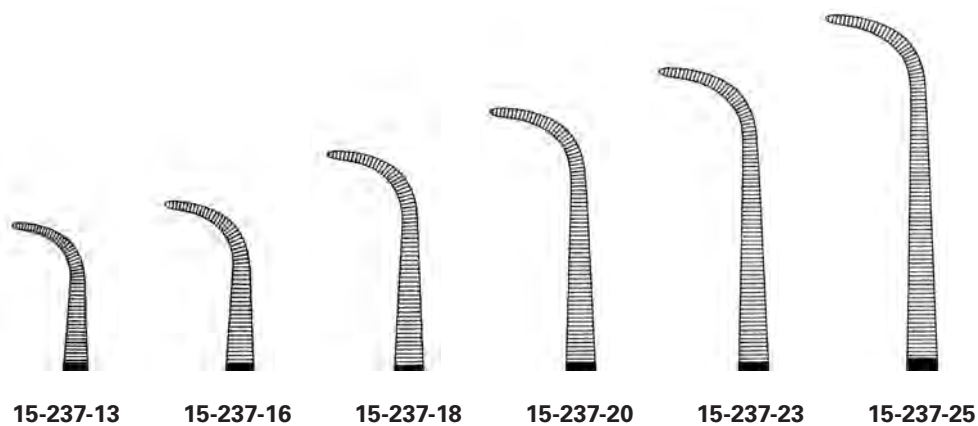
**15-234-28**



**15-235-28**

**BRIDGE**

**15-234-28 - 15-235-28** 28,0 cm, 11 "



15-237-13

15-237-16

15-237-18

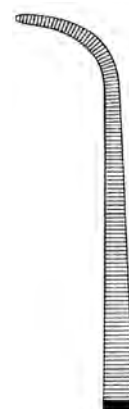
15-237-20

15-237-23

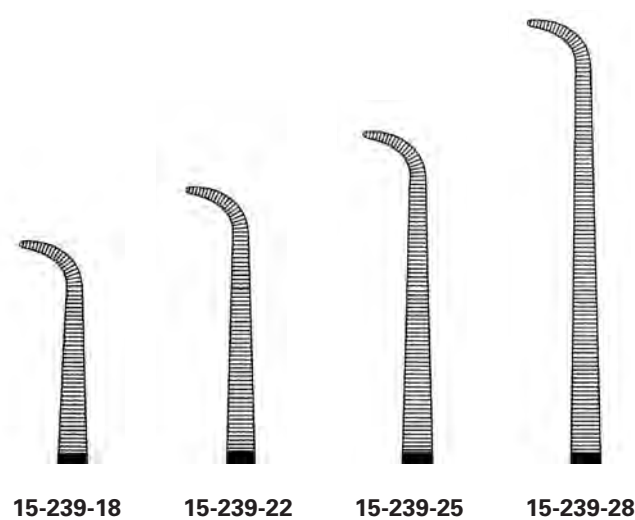
15-237-25

### GEMINI

15-237-13	13,0 cm, 5 1/8"
15-237-16	16,0 cm, 6 1/4"
15-237-18	18,0 cm, 7"
15-237-20	20,0 cm, 8"
15-237-23	23,0 cm, 9"
15-237-25	25,0 cm, 9 3/4"
15-237-28	28,0 cm, 11"



15-237-28



15-239-18

15-239-22

15-239-25

15-239-28

### GEMINI

15-239-18	18,0 cm, 7"
15-239-22	22,0 cm, 8 3/4"
15-239-25	25,0 cm, 9 3/4"
15-239-28	28,0 cm, 11"



**15-241-20**  
**15-241-24**  
**15-241-28**

**KANTROWITZ**

<b>15-241-20</b>	20,0 cm, 8 "
<b>15-241-24</b>	24,0 cm, 9 ½ "
<b>15-241-28</b>	28,0 cm, 11 "



**15-243-18**      **15-243-28**

**MEEKER**

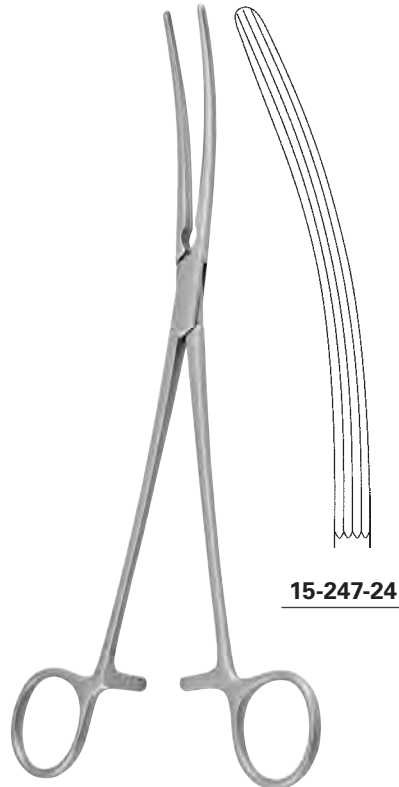
<b>15-243-18</b>	18,0 cm, 7 "
<b>15-243-28</b>	28,0 cm, 11 "



**18-245-18**      **18-245-24**

**CRAFOORD**

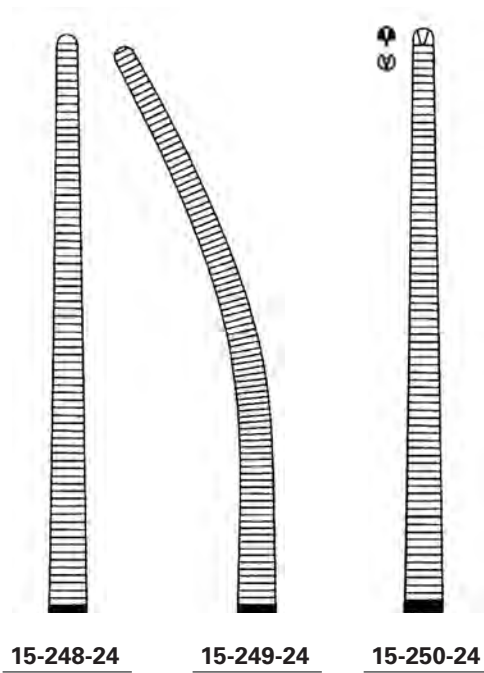
<b>18-245-18</b>	18,0 cm, 7 "
<b>18-245-24</b>	24,0 cm, 9 ½ "



**15-247-24**

**CRAFOORD-SELLORS**

<b>15-247-24</b>	24,0 cm, 9 ½ "
------------------	----------------



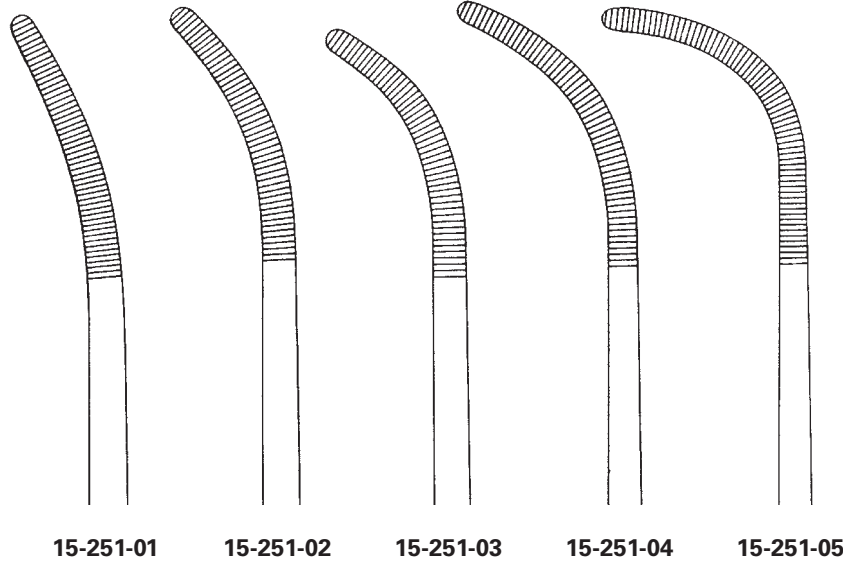
15-248-24

15-249-24

15-250-24

### SAROT

15-248-24 - 15-250-24 24,0 cm, 9 1/2"



15-251-01

15-251-02

15-251-03

15-251-04

15-251-05

### RUMEL

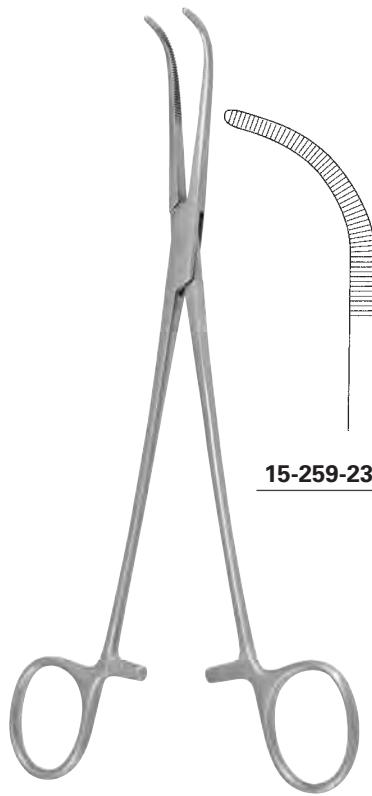
15-251-01 - 15-251-05 23,0 cm, 9"



**15-259-22**

**MIXTER**

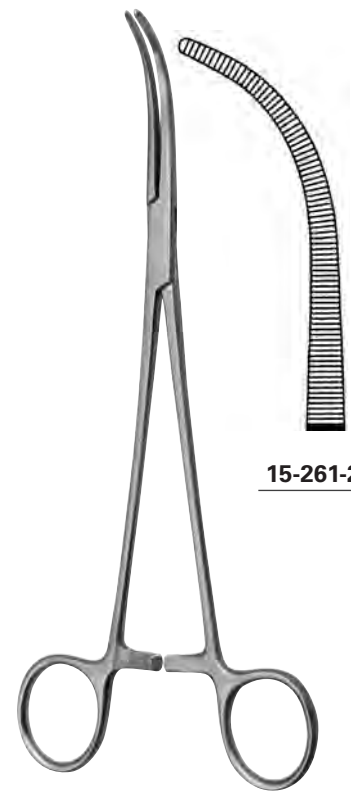
**15-259-22** 22,0 cm, 8 3/4"



**15-259-23**

**MIXTER**

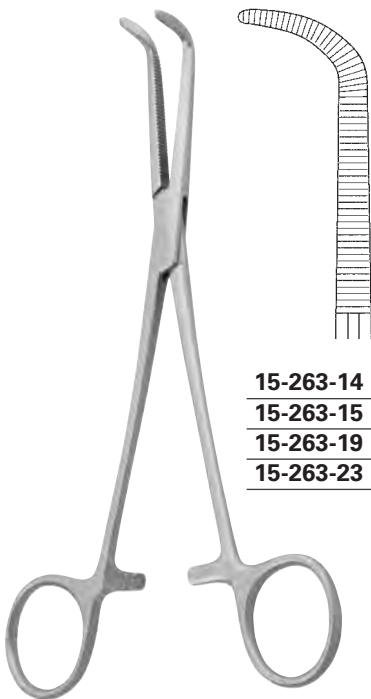
**15-259-23** 23,0 cm, 9"



**15-261-21**

**OVERHOLT-MIXTER**

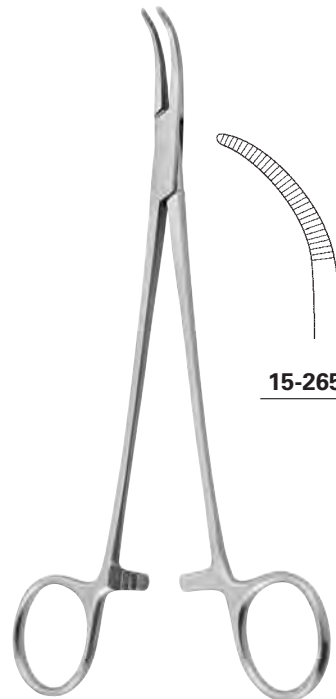
**15-261-21** 21,0 cm, 8 1/4"



**15-263-14**  
**15-263-15**  
**15-263-19**  
**15-263-23**

**MIXTER**

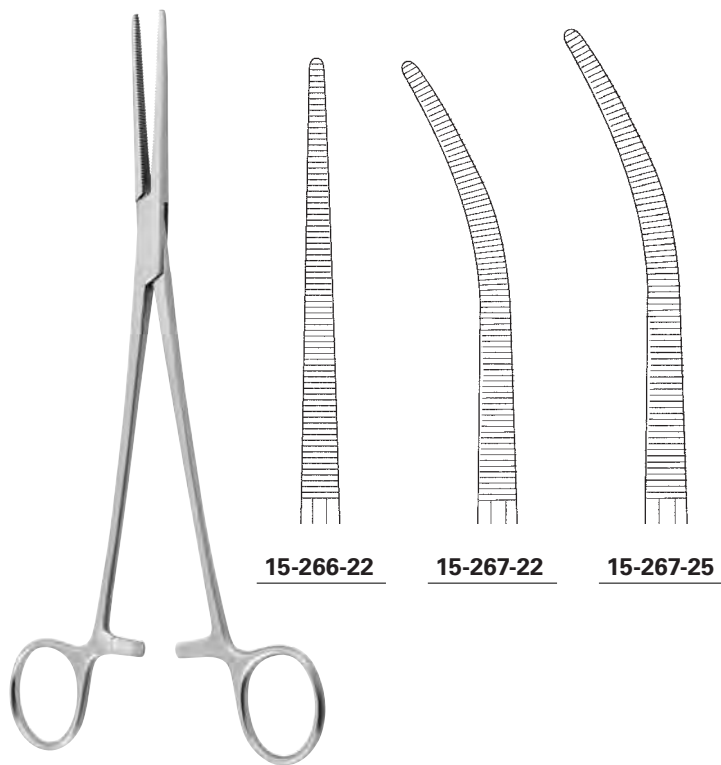
**15-263-14** 14,0 cm, 5 1/2"  
**15-263-15** 15,0 cm, 6"  
**15-263-19** 19,0 cm, 7 1/2"  
**15-263-23** 23,0 cm, 9"



**15-265-18**

**MIXTER**

**15-265-18** 18,0 cm, 7"



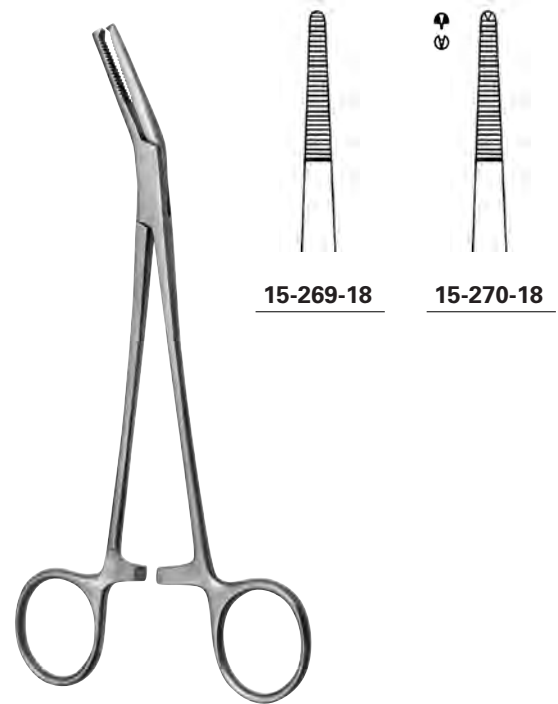
**15-266-22**

**15-267-22**

**15-267-25**

**ROBERTS**

**15-266-22 - 15-267-22** 22,0 cm, 8 3/4 "  
**15-267-25** 25,0 cm, 9 3/4 "

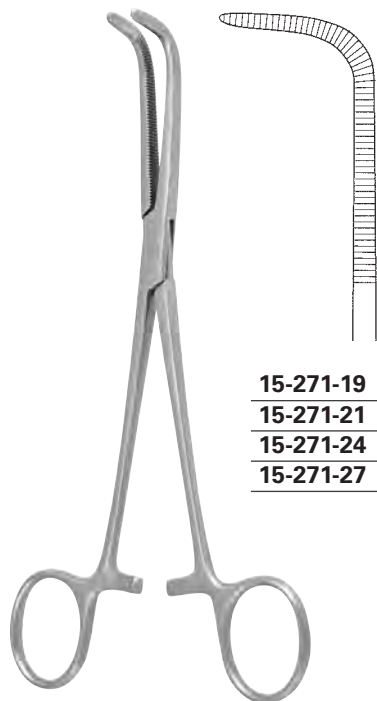


**15-269-18**

**15-270-18**

**FICKLING**

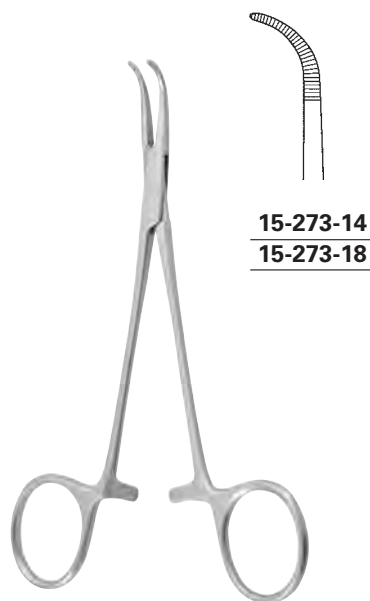
**15-269-18 - 15-270-18** 18,0 cm, 7 "



**15-271-19**  
**15-271-21**  
**15-271-24**  
**15-271-27**

**WIKSTROEM**

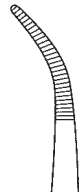
**15-271-19** 19,0 cm, 7 1/2 "  
**15-271-21** 21,0 cm, 8 1/4 "  
**15-271-24** 24,0 cm, 9 1/2 "  
**15-271-27** 27,0 cm, 10 3/4 "



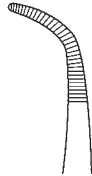
**15-273-14**  
**15-273-18**

**BABY-ADSON**

**15-273-14** 14,0 cm, 5 1/2 "  
**15-273-18** 18,0 cm, 7 "



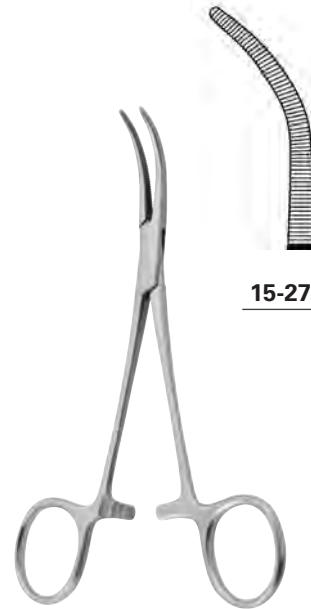
**15-275-01**



**15-275-02**

**BABY-MIXTER**

**15-275-01 - 15-275-02** 14,0 cm, 5 ½"



**15-279-13**

**BABY-OVERHOLT**

**15-279-13** 13,0 cm, 5 ⅛"



**15-281-19**  
**15-281-22**  
**15-281-24**



**15-283-19**  
**15-283-22**  
**15-283-24**



**15-285-19**  
**15-285-22**  
**15-285-24**

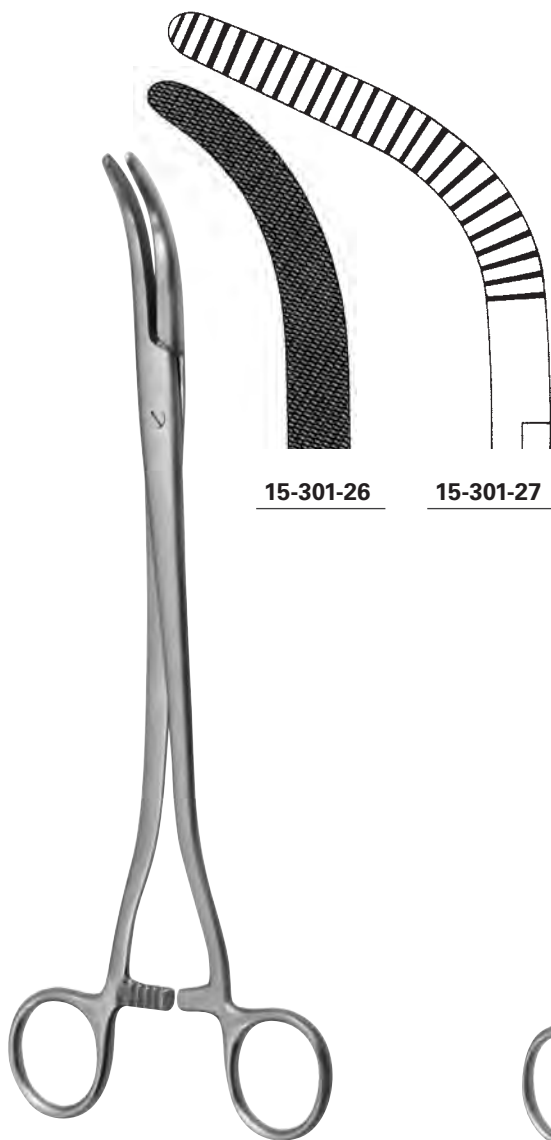
**KELLY**

**15-281-19 - 15-285-19** 19,0 cm, 7 ½"

**15-281-22 - 15-285-22** 22,0 cm, 8 ¾"

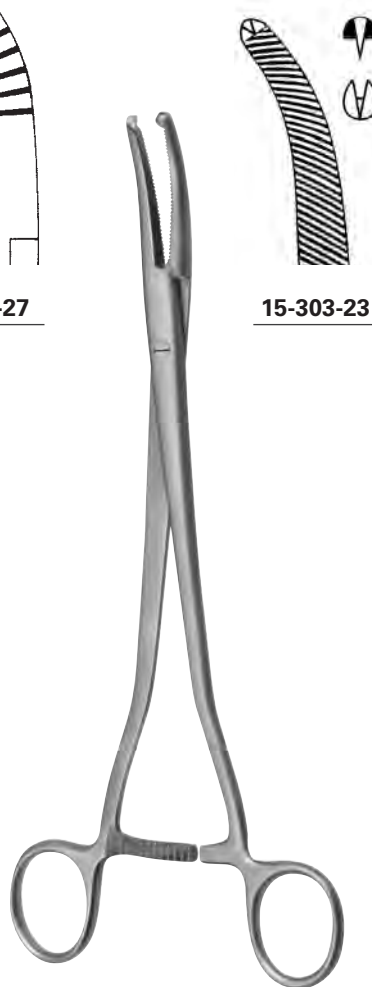
**15-281-24 - 15-285-24** 24,0 cm, 9 ½"





15-301-26

15-301-27



15-303-23



15-303-24

**WERTHEIM**

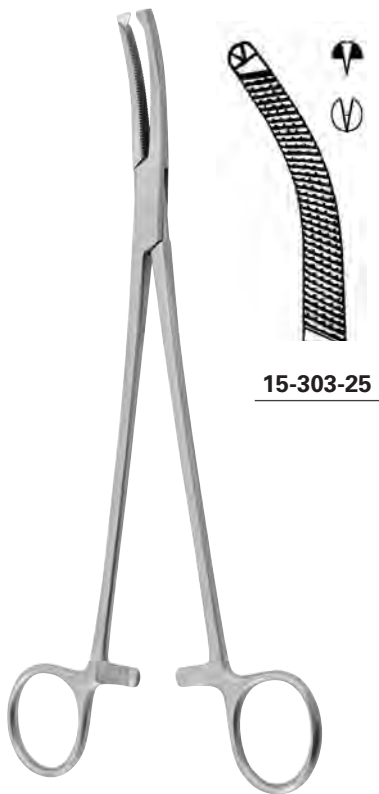
**15-301-26** 26,0 cm, 10 1/4"  
**15-301-27** 27,0 cm, 10 3/4"

**WERTHEIM**

**15-303-23** 23,5 cm, 9 1/4"

**WERTHEIM**

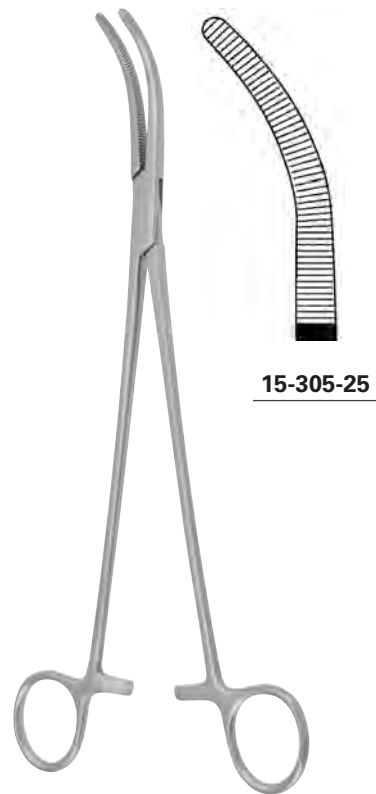
**15-303-24** 23,5 cm, 9 1/4"



**15-303-25**

**WERTHEIM**

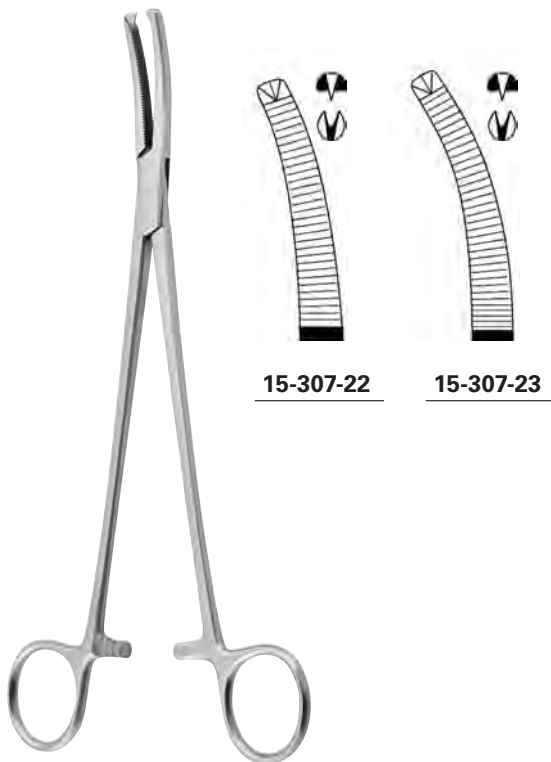
**15-303-25** 24,5 cm, 9 ⅜"



**15-305-25**

**WERTHEIM**

**15-305-25** 25,0 cm, 9 ¾"



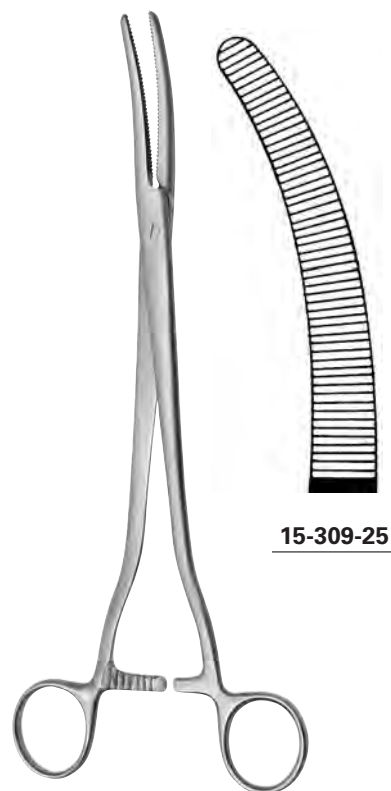
**15-307-22**

**15-307-23**

**WERTHEIM**

**15-307-22** 22,0 cm, 8 ¾"

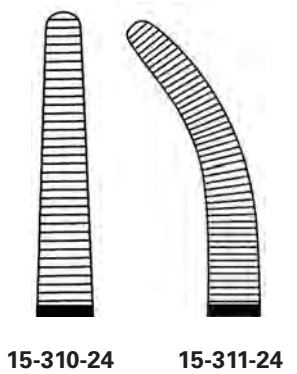
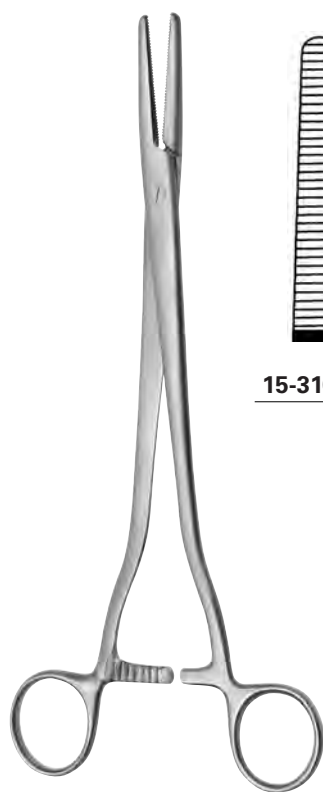
**15-307-23** 23,0 cm, 9"



**15-309-25**

**FAURE**

**15-309-25** 25,0 cm, 9 ¾"

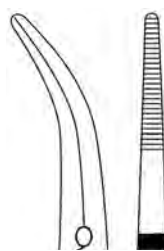


**15-310-24**

**15-311-24**

**SEGOND-LANDAU**

**15-310-24 - 15-311-24** 24,0 cm, 9 ½"



**15-313-14**

**MOYNIHAN**

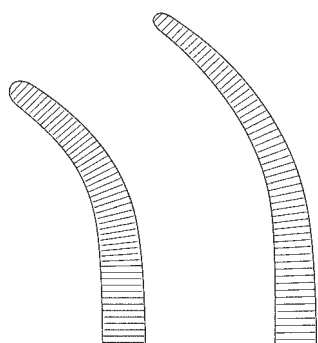
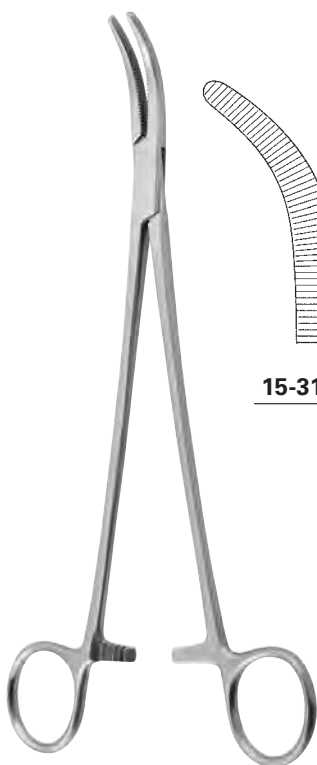
**15-313-14** 14,5 cm, 5 ¾"



**15-313-15**

**MOYNIHAN**

**15-313-15** 15,0 cm, 6"

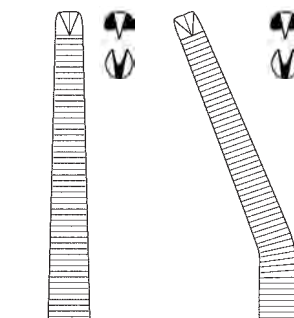
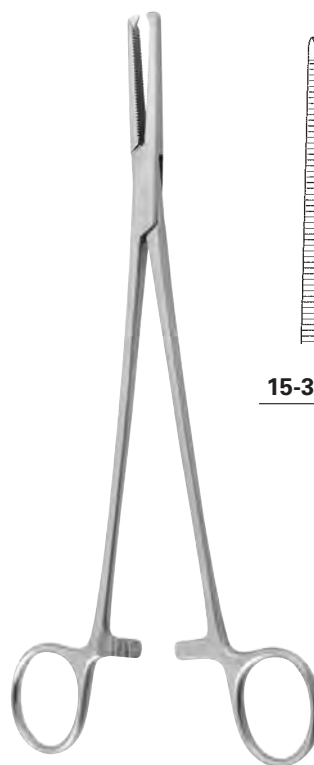


**15-313-23**

**15-313-24**

**MOYNIHAN**

**15-313-23** 23,0 cm, 9"  
**15-313-24** 24,0 cm, 9 ½"

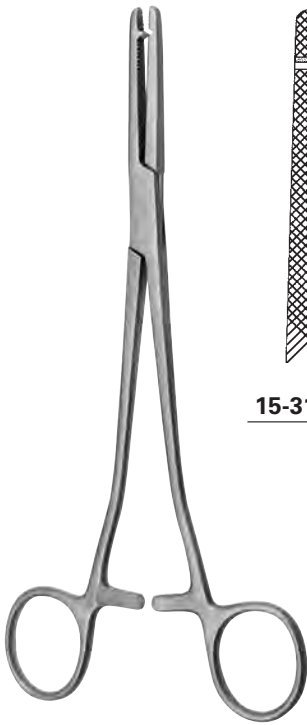


**15-314-21**

**15-315-21**

**PHANEUF**

**15-314-21 - 15-315-21** 21,0 cm, 8 ¼"



**15-316-21**

**HEANEY-RAZAK**

**15-316-21** 21,0 cm, 8 ¼"



**15-317-20**

**15-317-21**

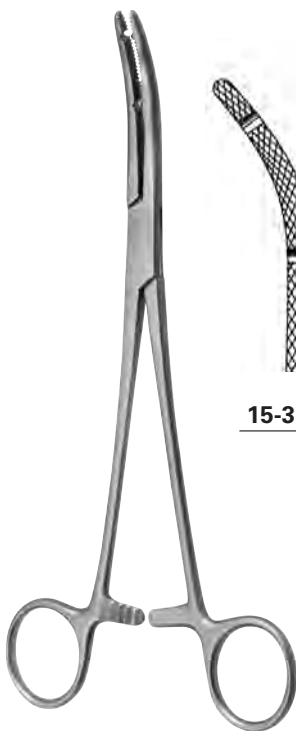
**15-317-23**

**HEANEY**

**15-317-20** 20,0 cm, 8"

**15-317-21** 21,0 cm, 8 ¼"

**15-317-23** 23,0 cm, 9"



**15-319-20**

**15-319-21**

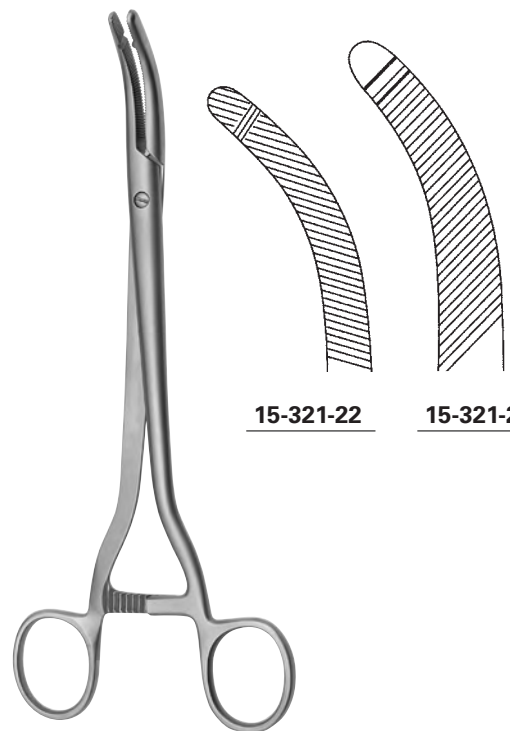
**15-319-23**

**HEANEY**

**15-319-20** 20,0 cm, 8"

**15-319-21** 21,0 cm, 8 ¼"

**15-319-23** 23,0 cm, 9"



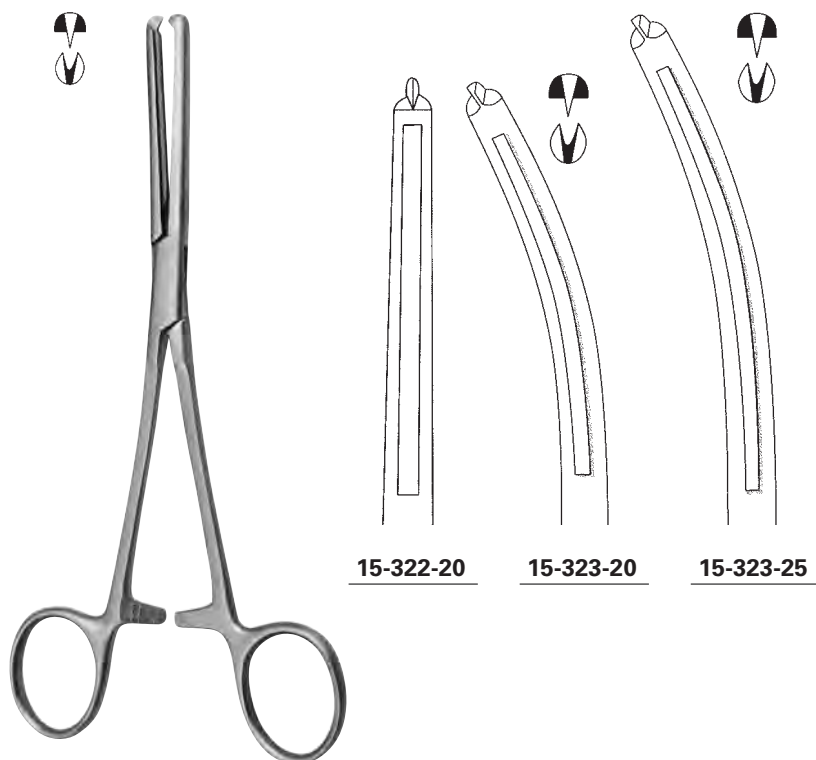
**15-321-22**

**15-321-24**

**WIENER MOD.**

**15-321-22** 22,0 cm, 8 ¾"

**15-321-24** 24,0 cm, 9 ½"



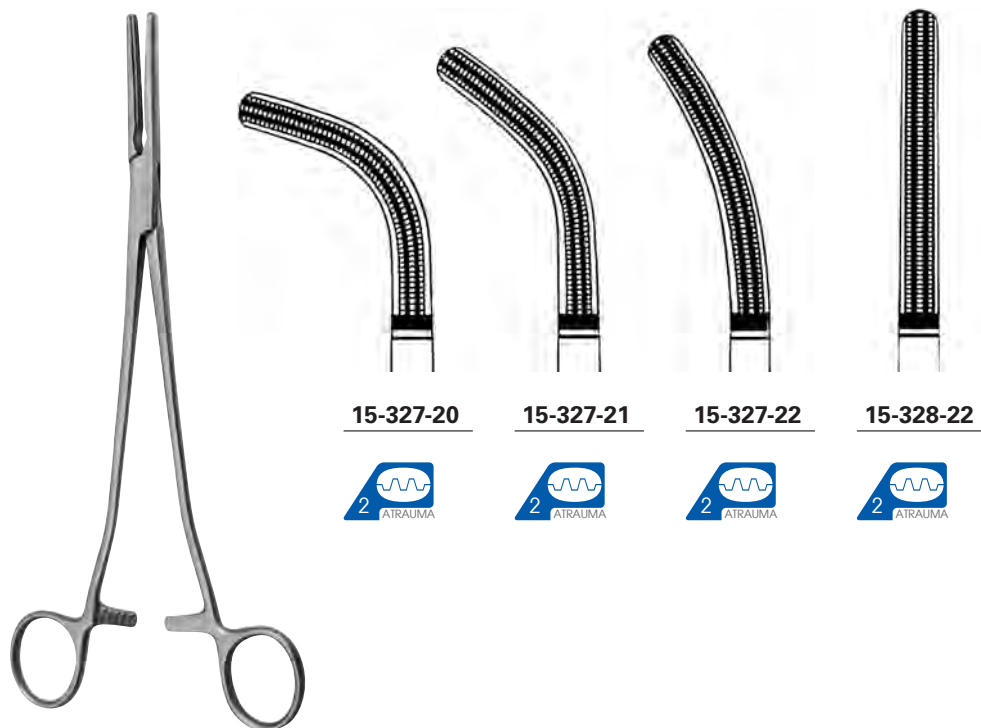
15-322-20

15-323-20

15-323-25

### MAINGOTT

15-322-20 - 15-323-20 20,0 cm, 8 "  
15-323-25 25,0 cm, 9 3/4 "



15-327-20

15-327-21

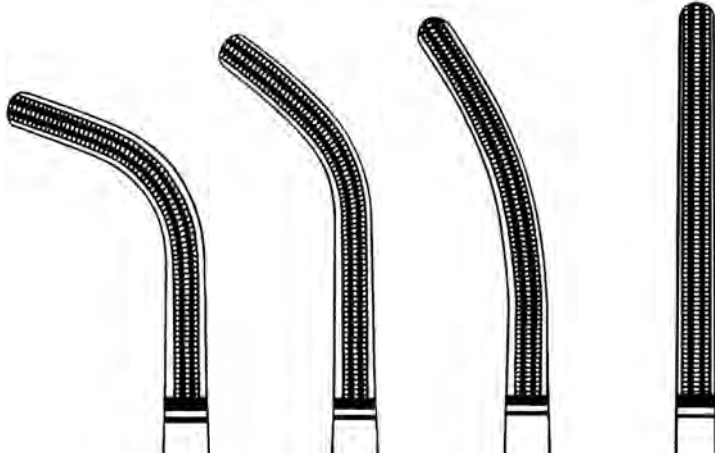
15-327-22

15-328-22



### ROGERS

15-327-20 20,0 cm, 8 "  
15-327-21 21,0 cm, 8 1/4 "  
15-327-22 - 15-328-22 22,0 cm, 8 3/4 "



**15-329-23**

**15-329-24**

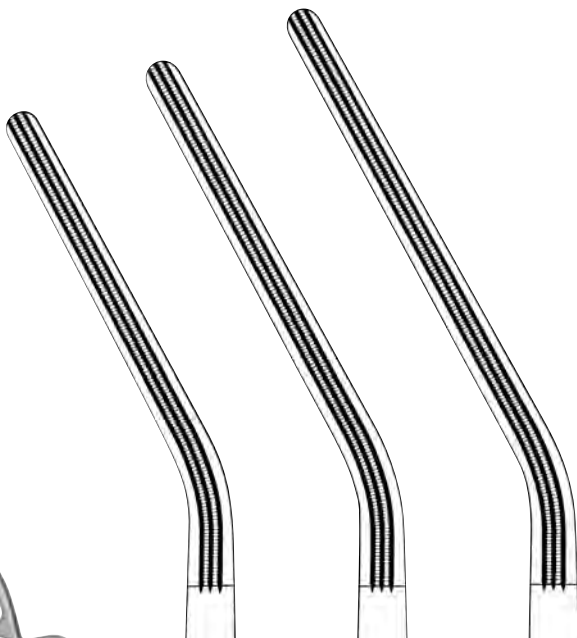
**15-329-25**

**15-330-25**



**ROGERS**

<b>15-329-23</b>	23,0 cm, 9"
<b>15-329-24</b>	24,0 cm, 9 1/2"
<b>15-329-25 - 15-330-25</b>	25,0 cm, 9 3/4"



**15-331-25**

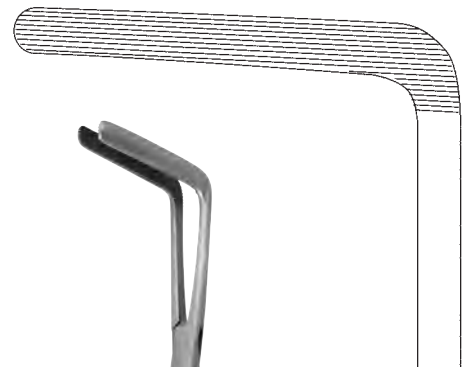
**15-331-26**

**15-331-27**



**DICK**

<b>15-331-25</b>	25,0 cm, 9 3/4"
<b>15-331-26</b>	26,0 cm, 10 1/4"
<b>15-331-27</b>	27,0 cm, 10 3/4"



**15-335-21**



**WERTHEIM-CULLEN**

<b>15-335-21</b>	21,0 cm, 8 1/4"
------------------	-----------------



**15-338-15**

**PRATT**

**15-338-15** 15,0 cm, 6"



**15-339-18**

**MIKULICZ**

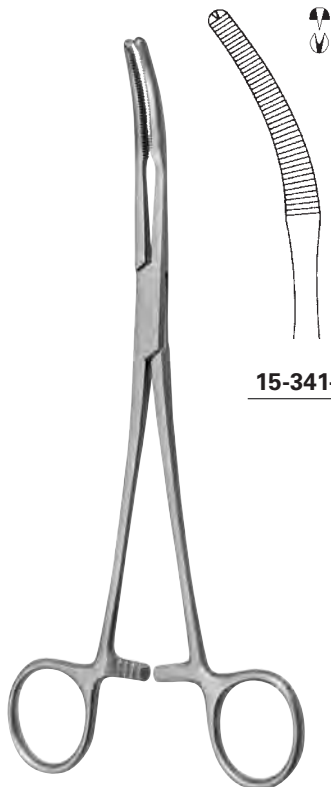
**15-339-18** 18,5 cm, 7 1/4"



**15-339-20**

**MIKULICZ**

**15-339-20** 20,5 cm, 8"



**15-341-20**

**MIKULICZ**

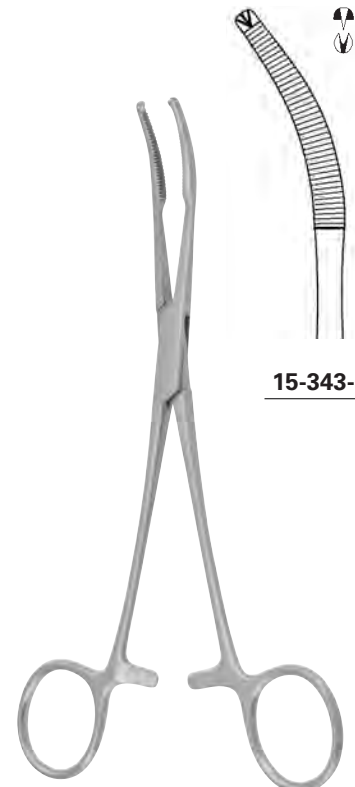
**15-341-20** 20,0 cm, 8"



**15-343-14**

**BABY-MIKULICZ**

**15-343-14** 14,0 cm, 5 1/2"



**15-343-18**

**MIKULICZ**

**15-343-18** 18,0 cm, 7"

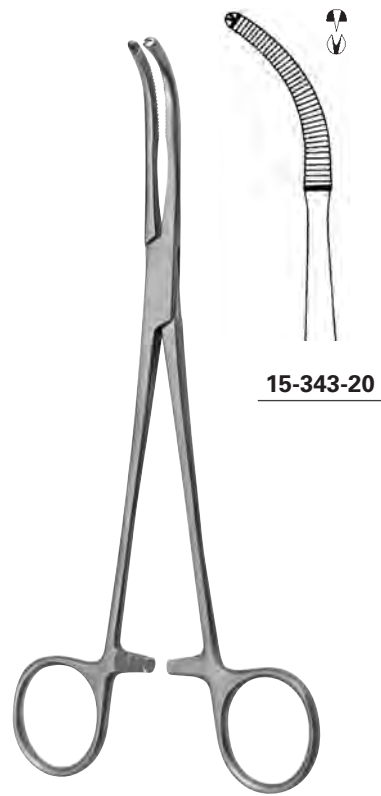




**15-343-19**

**MIKULICZ**

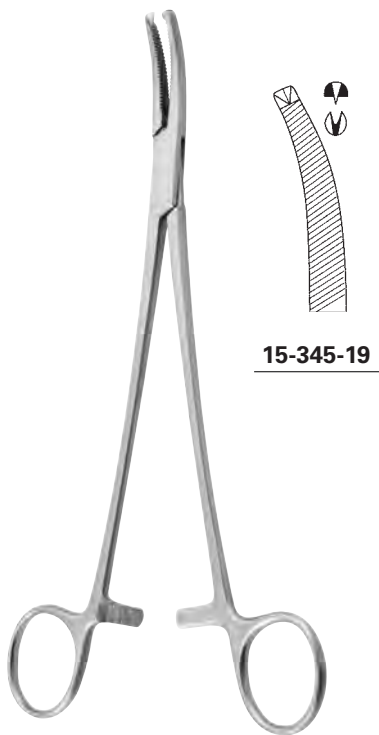
**15-343-19** 18,0 cm, 7"



**15-343-20**

**MIKULICZ**

**15-343-20** 20,0 cm, 8"

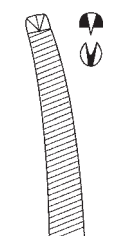


**15-345-19**

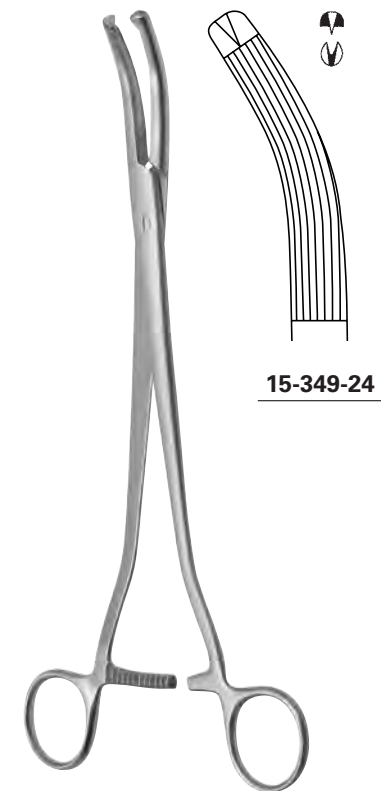
**FAURE**

**15-345-19** 19,0 cm, 7 1/2"

**15-345-20** 20,0 cm, 8"



**15-345-20**

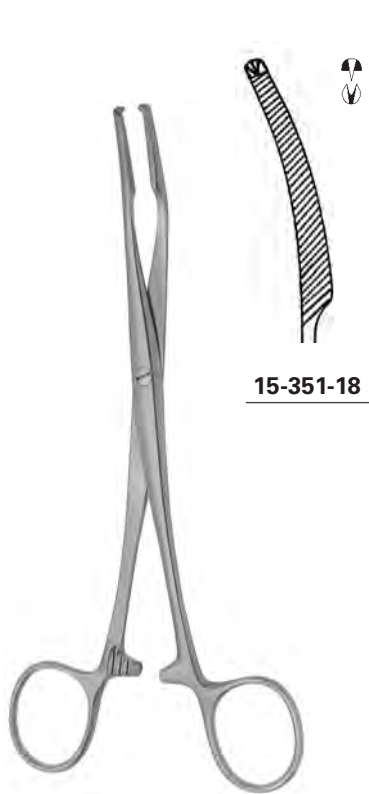


**15-349-24**

**MIKULICZ**

**15-349-24** 24,5 cm, 9 2/3"

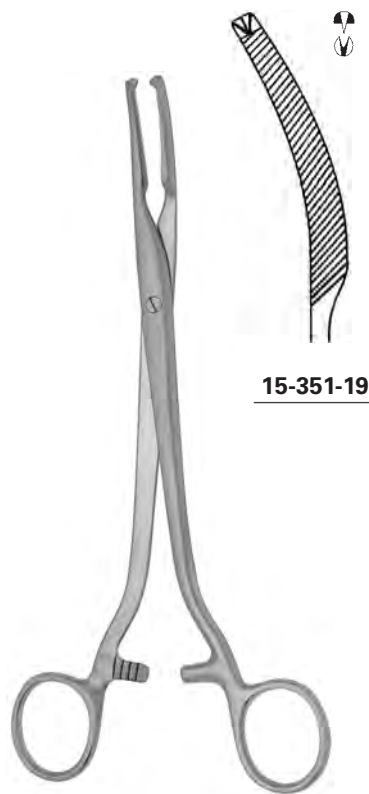




**15-351-18**

**MIKULICZ**

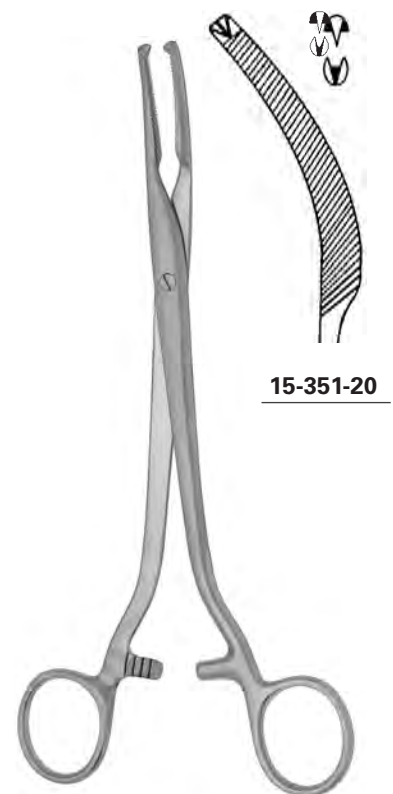
**15-351-18** 18,0 cm, 7"



**15-351-19**

**MIKULICZ**

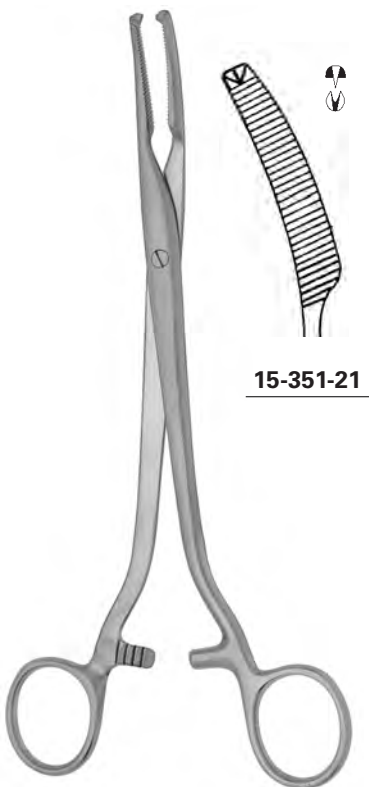
**15-351-19** 19,0 cm, 7 1/2"



**15-351-20**

**MIKULICZ**

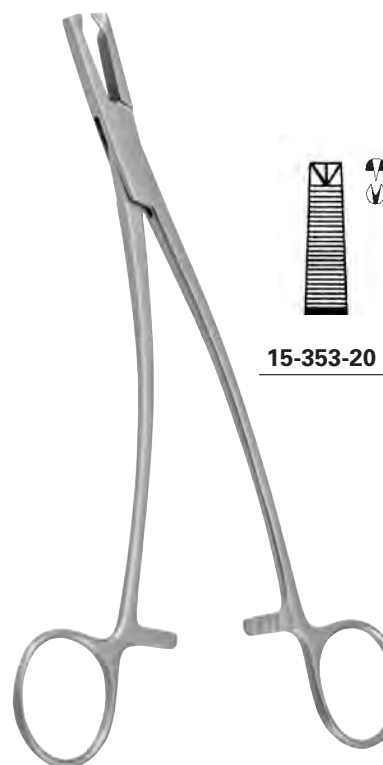
**15-351-20** 20,0 cm, 8"



**15-351-21**

**MIKULICZ**

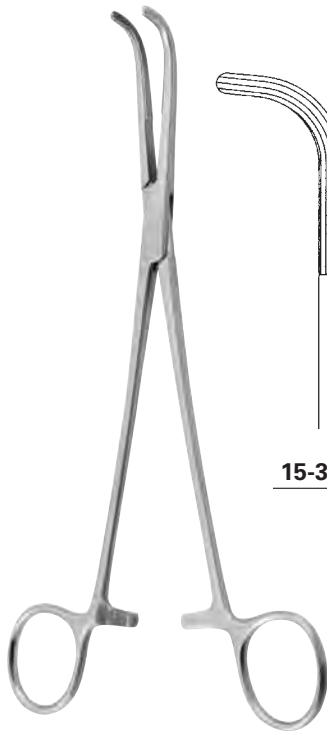
**15-351-21** 21,0 cm, 8 1/4"



**15-353-20**

**SCHINDLER**

**15-353-20** 20,0 cm, 8"



**15-355-22**

**15-355-25**

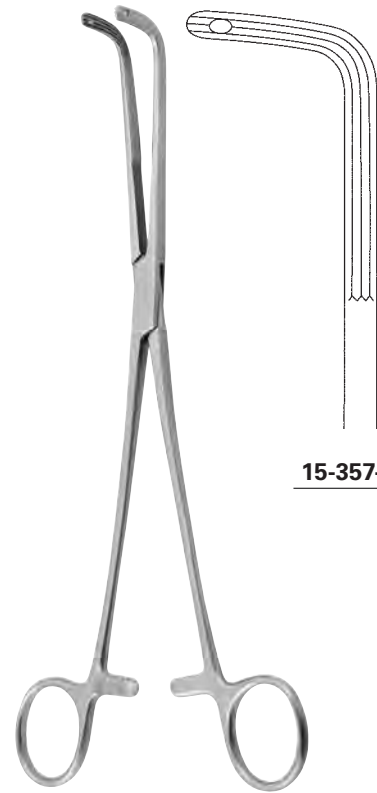
**15-355-28**

**MIXTER**

**15-355-22** 22,0 cm, 8 3/4"

**15-355-25** 25,0 cm, 9 3/4"

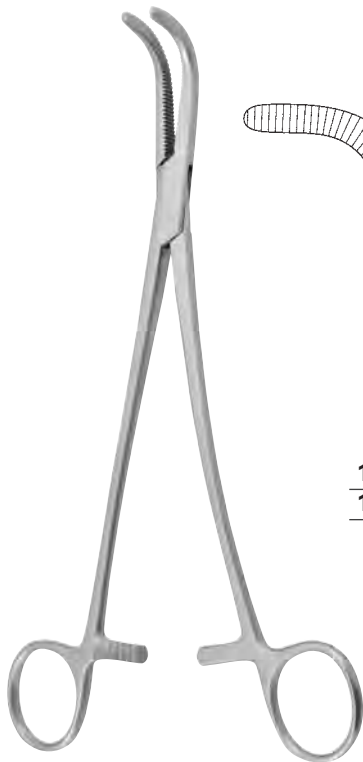
**15-355-28** 28,0 cm, 11"



**15-357-24**

**FINOCHIETTO**

**15-357-24** 24,0 cm, 9 1/2"

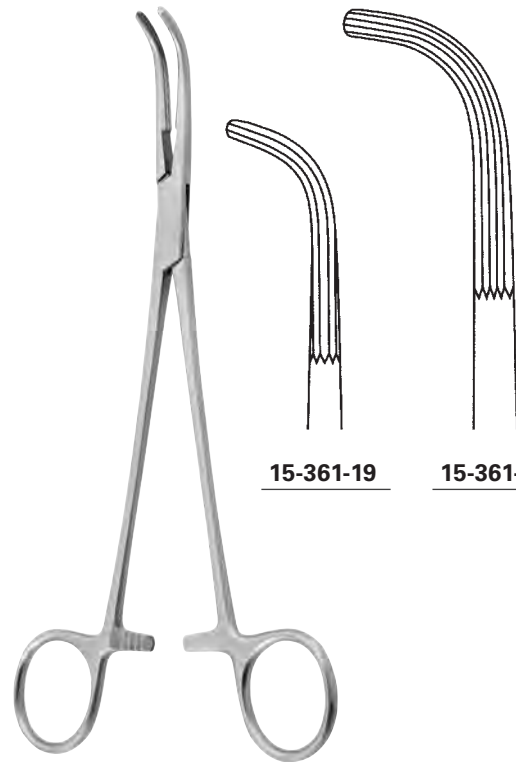


**15-359-22**  
**15-359-23**

**GRAY**

**15-359-22** 22,0 cm, 8 3/4"

**15-359-23** 23,0 cm, 9"



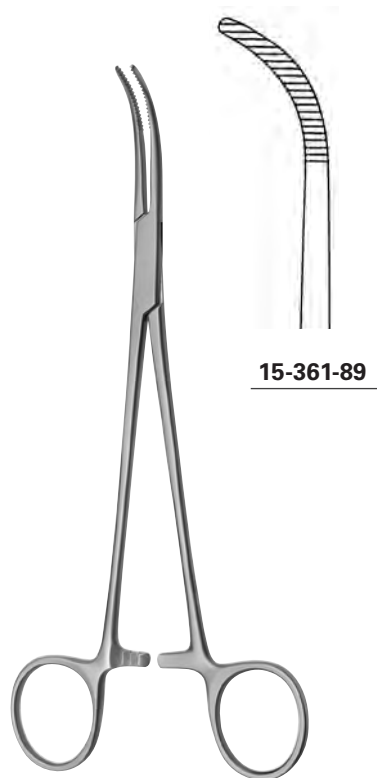
**15-361-19**

**15-361-23**

**LAHEY**

**15-361-19** 19,0 cm, 7 1/2"

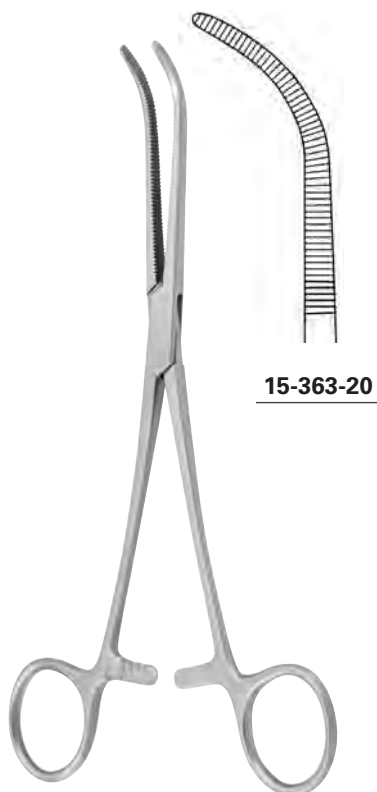
**15-361-23** 23,0 cm, 9"



**15-361-89**

**LAHEY**

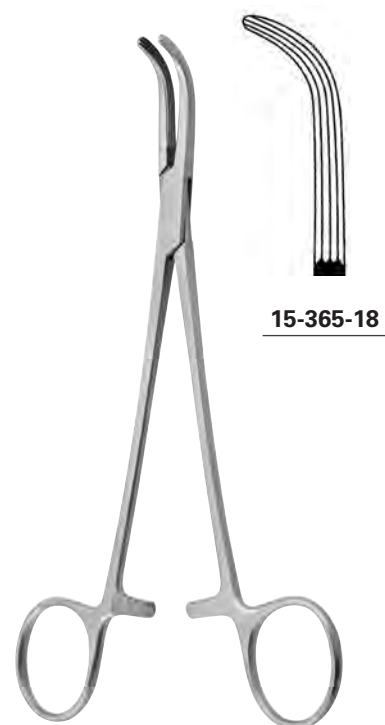
**15-361-89** 19,0 cm, 7 ½"



**15-363-20**

**JOHNS-HOPKINS**

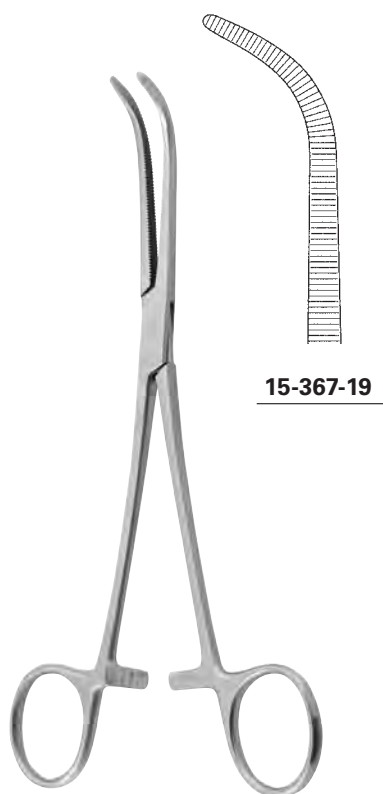
**15-363-20** 20,0 cm, 8"



**15-365-18**

**LOWER**

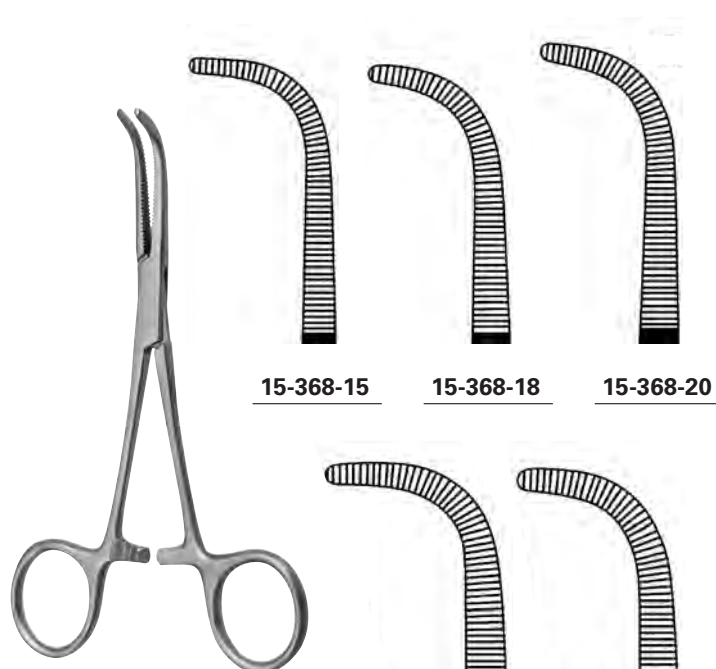
**15-365-18** 18,0 cm, 7"



**15-367-19**

**MIXTER-O'SHAUGNESSY**

**15-367-19** 19,0 cm, 7 ½"



**15-368-15**

**15-368-18**

**15-368-20**

**O'SHAUGNESSY**

**15-368-15** 15,0 cm, 6"

**15-368-18** 18,0 cm, 7"

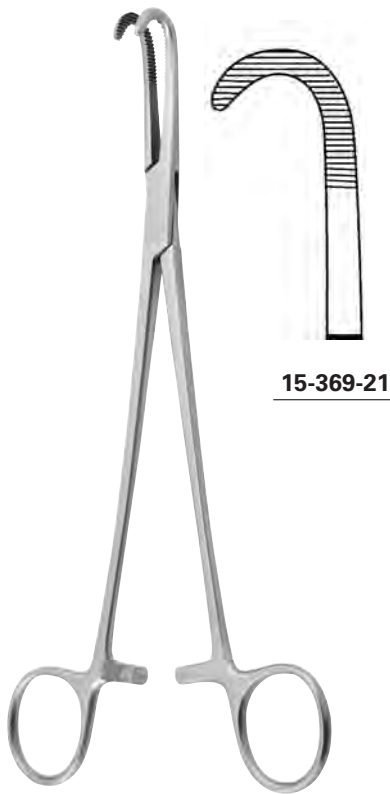
**15-368-20** 20,0 cm, 8"

**15-368-23** 23,0 cm, 9"

**15-368-25** 25,0 cm, 10"

**15-368-23**

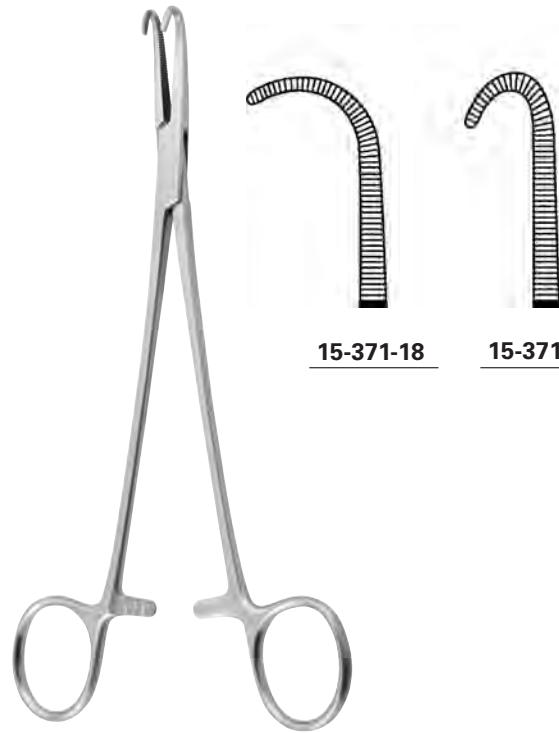
**15-368-25**



**15-369-21**

**DESJARDINS**

**15-369-21** 21,0 cm, 8 ¼"



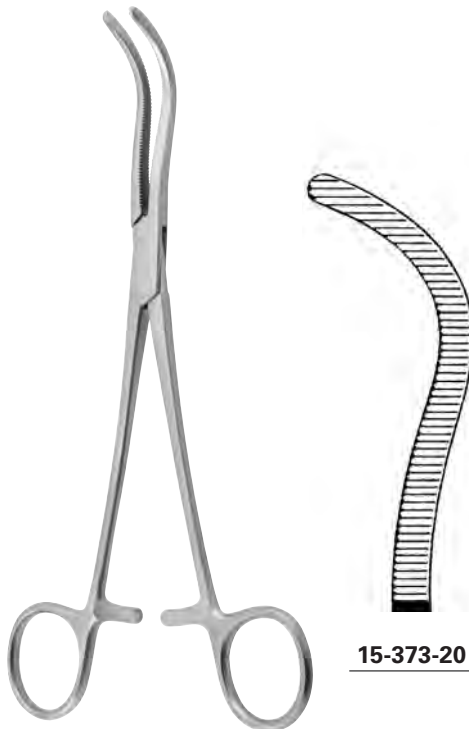
**15-371-18**

**15-371-19**

**NEGUS**

**15-371-18** 18,0 cm, 7"

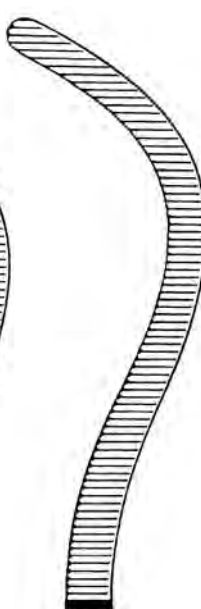
**15-371-19** 19,0 cm, 7 ½"



**15-373-20**



**15-373-22**



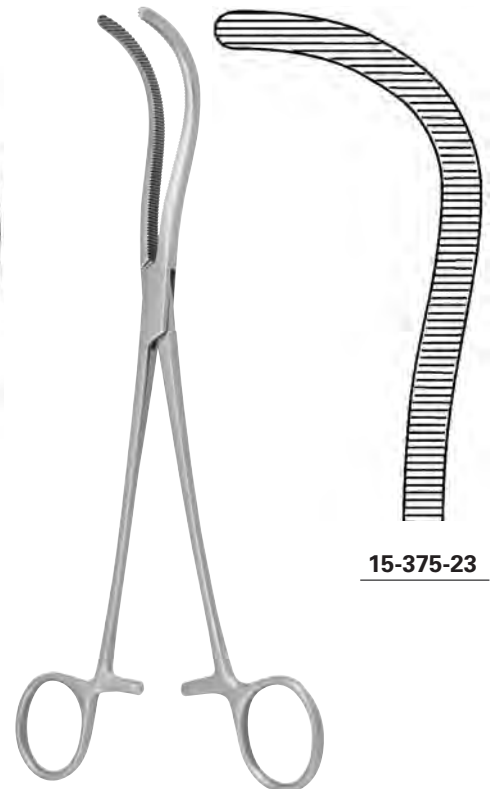
**15-373-24**

**GUYON**

**15-373-20** 20,0 cm, 8"

**15-373-22** 22,0 cm, 8 ¾"

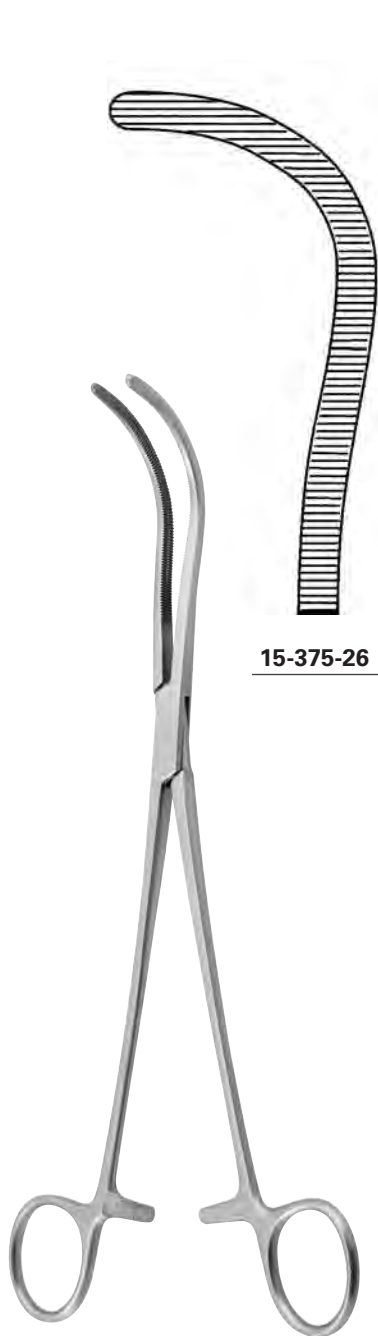
**15-373-24** 24,0 cm, 9 ½"



**15-375-23**

**GUYON**

**15-375-23** 23,0 cm, 9"



**15-375-26**

**GUYON**

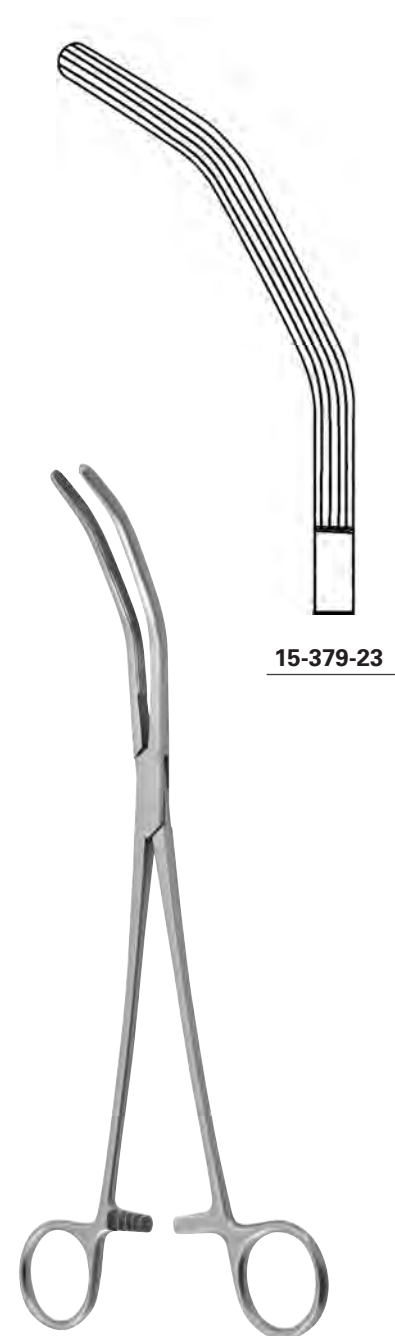
**15-375-26** 26,5 cm, 10 1/2"



**15-377-23**

**STILLE**

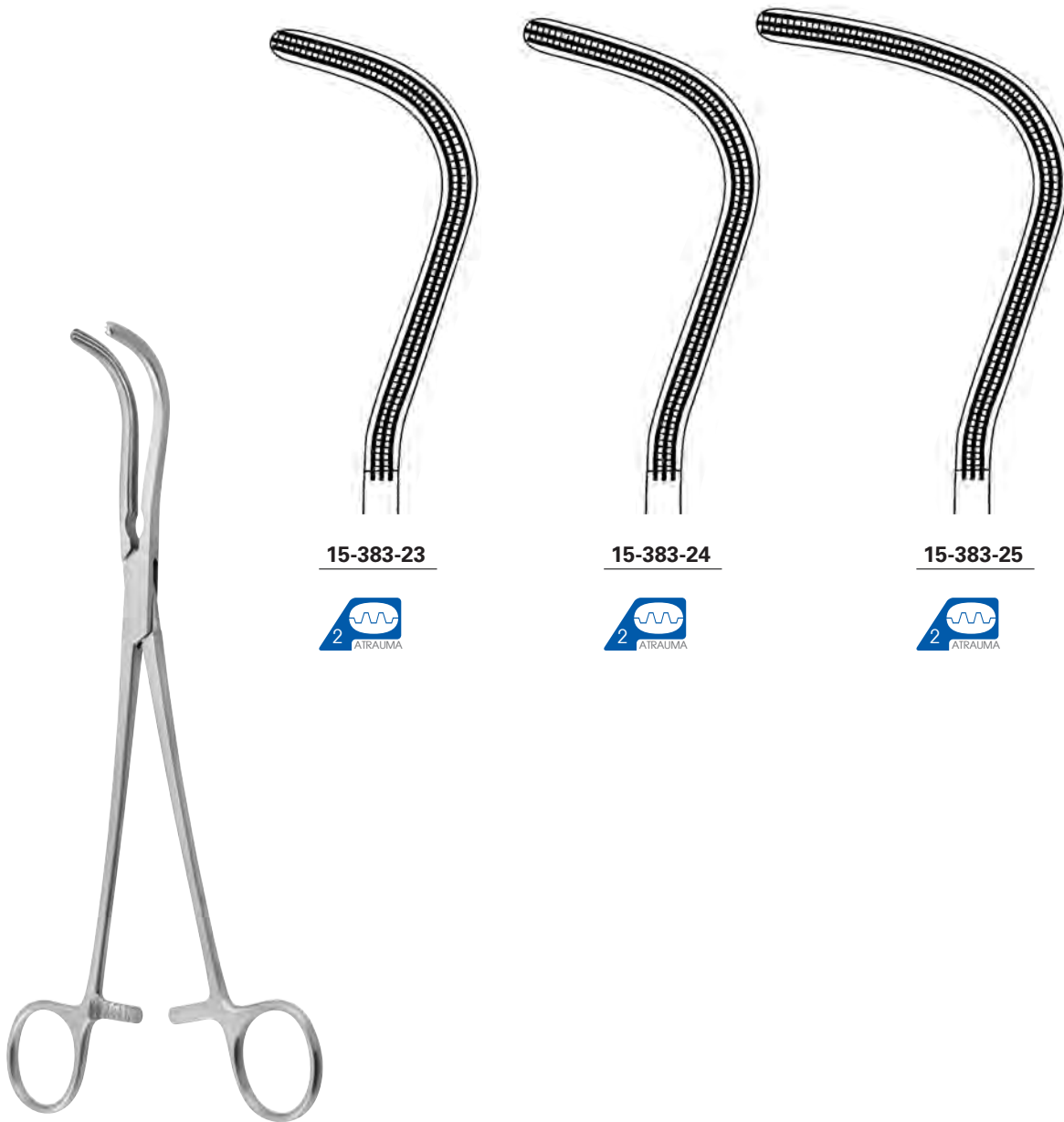
**15-377-23** 23,0 cm, 9"



**15-379-23**

**HERRICK**

**15-379-23** 23,0 cm, 9"



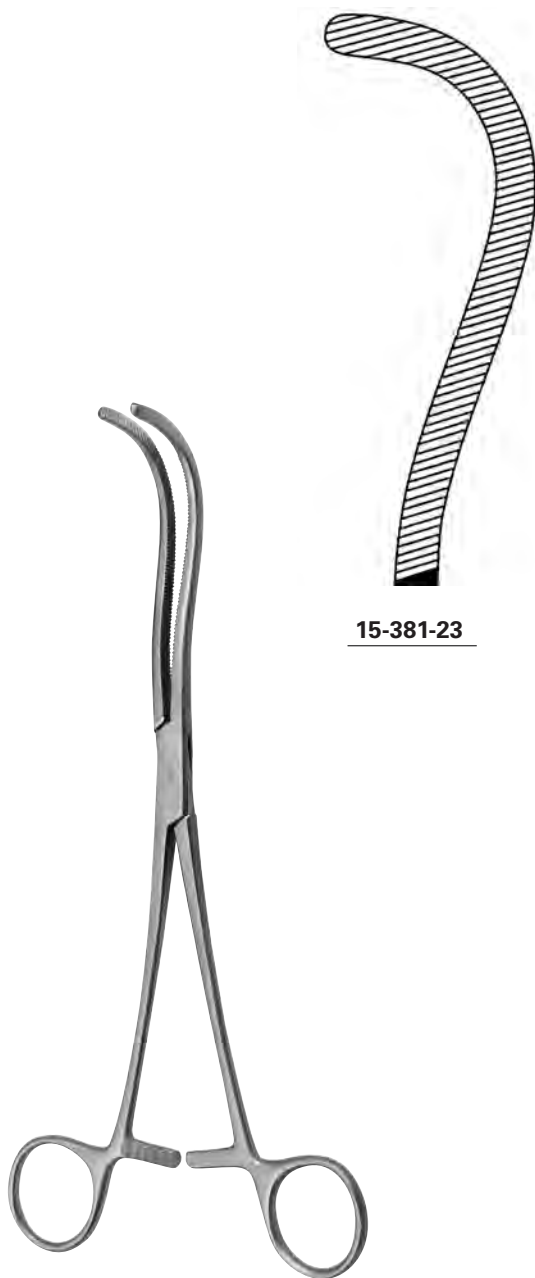
**15-383-23**

**15-383-24**

**15-383-25**

**GUYON**

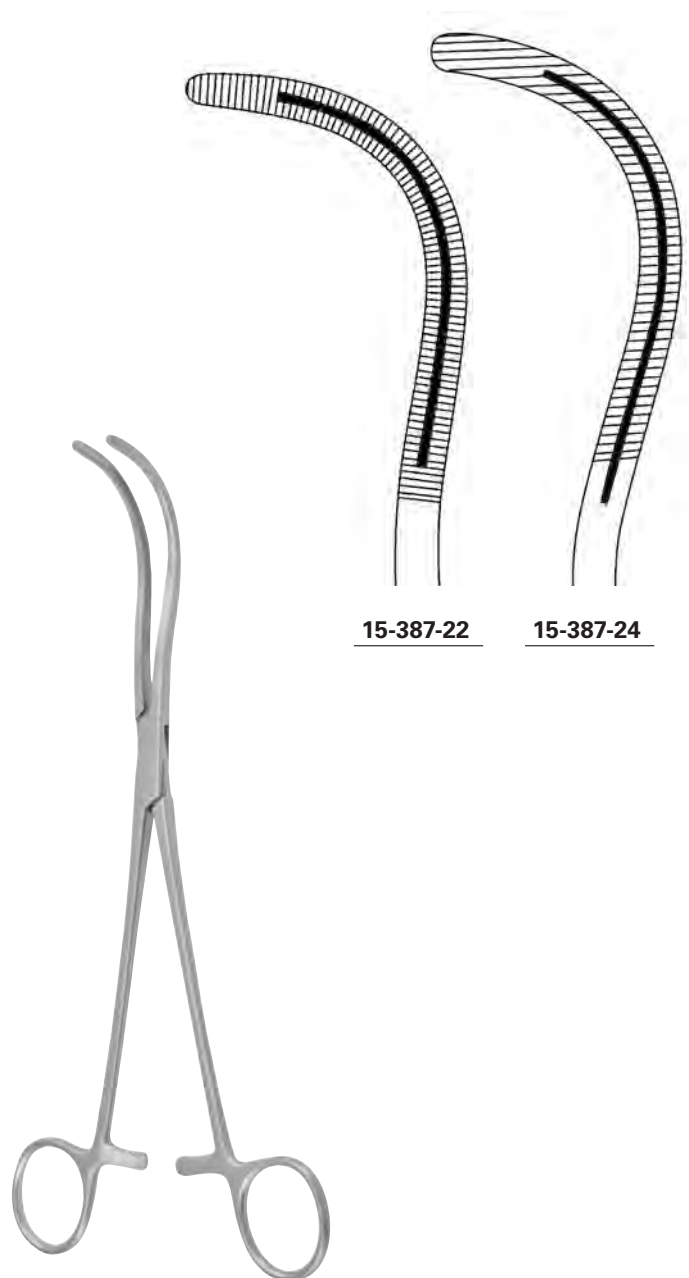
<b>15-383-23</b>	23,0 cm, 9"
<b>15-383-24</b>	24,0 cm, 9 1/2"
<b>15-383-25</b>	24,0 cm, 9 1/2"



**15-381-23**

**MAYO-GUYON**

**15-381-23** 23,0 cm, 9"



**15-387-22**

**15-387-24**

**STILLE**

**15-387-22** 22,0 cm, 8 <sup>3</sup>/<sub>4</sub>"

**15-387-24** 24,0 cm, 9 <sup>1</sup>/<sub>2</sub>"



15-390-22  
15-390-25  
15-390-30  
15-390-35

15-391-22  
15-391-25  
15-391-30  
15-391-35

15-393-21  
15-393-25  
15-393-30  
15-393-35

15-395-21  
15-395-25  
15-395-30  
15-395-35



### Z-PARAMETRIUM

<b>15-391-22 - 15-395-21</b>	21,0 cm, 8 1/4"
<b>15-390-22 - 15-393-22</b>	22,0 cm, 8 3/4"
<b>15-390-25 - 15-395-22</b>	25,0 cm, 9 3/4"
<b>15-390-30 - 15-395-30</b>	30,0 cm, 11 3/4"
<b>15-390-35 - 15-395-35</b>	35,0 cm, 13 3/4"





# 15

Mikro Instrumente  
Micro Instruments  
Instrumentos de micro  
Strumentario micro





**DE BAKEY**

**15-492-50** 50,0 mm



**15-494-08**



**15-494-09**



**15-494-10**



**15-494-12**



**DE BAKEY**

**15-494-08** 80,0 mm

**15-494-09** 90,0 mm

**15-494-10** 105,0 mm

**15-494-12** 124,0 mm



**DE BAKEY**

**15-493-48** 48,0 mm



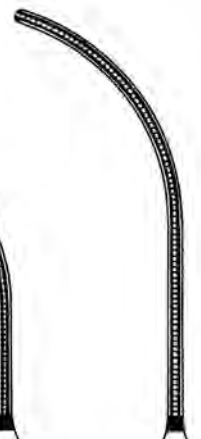
**15-495-08**



**15-495-09**



**15-495-10**



**15-495-11**



**DE BAKEY**

**15-495-08** 78,0 mm

**15-495-09** 86,0 mm

**15-495-10** 97,0 mm

**15-495-11** 114,0 mm



**15-494-07 T**

**15-494-08 T**

**15-494-09 T**



**15-494-10 T**

**15-494-11 T**

**15-494-12 T**

**15-494-13 T**

**DE BAKEY**

- 15-494-07 T** 70,0 mm

---

- 15-494-08 T** 80,0 mm

---

- 15-494-09 T** 90,0 mm

---

- 15-494-10 T** 100,0 mm

---

- 15-494-11 T** 110,0 mm

---

- 15-494-12 T** 120,0 mm

---

- 15-494-13 T** 130,0 mm

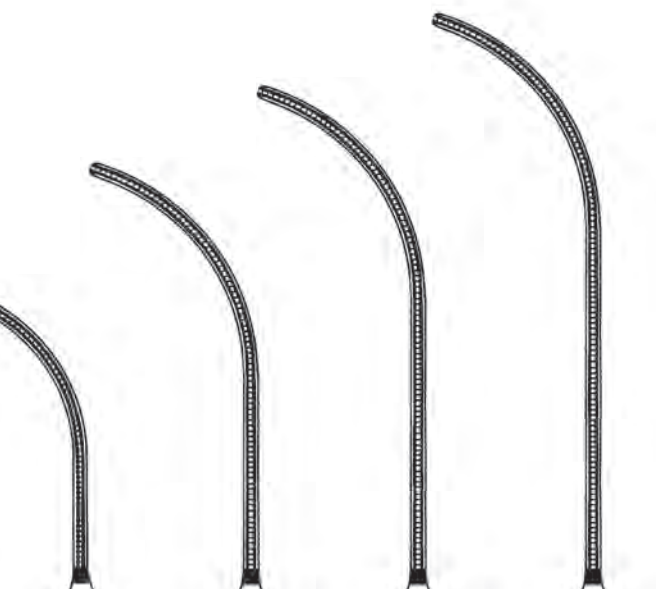
---




**15-495-07 T**

**15-495-08 T**

**15-495-09 T**



**15-495-10 T**

**15-495-11 T**

**15-495-12 T**

**15-495-13 T**

**DE BAKEY**

- 15-495-07 T** 70,0 mm

---

- 15-495-08 T** 80,0 mm

---

- 15-495-09 T** 90,0 mm

---

- 15-495-10 T** 100,0 mm

---

- 15-495-11 T** 110,0 mm

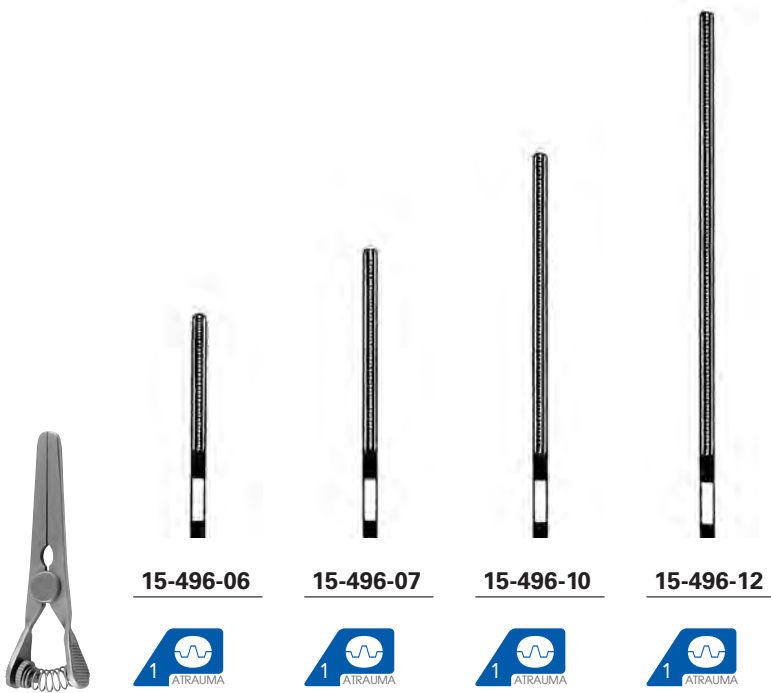
---

- 15-495-12 T** 120,0 mm

---

- 15-495-13 T** 130,0 mm

---



**15-496-06**

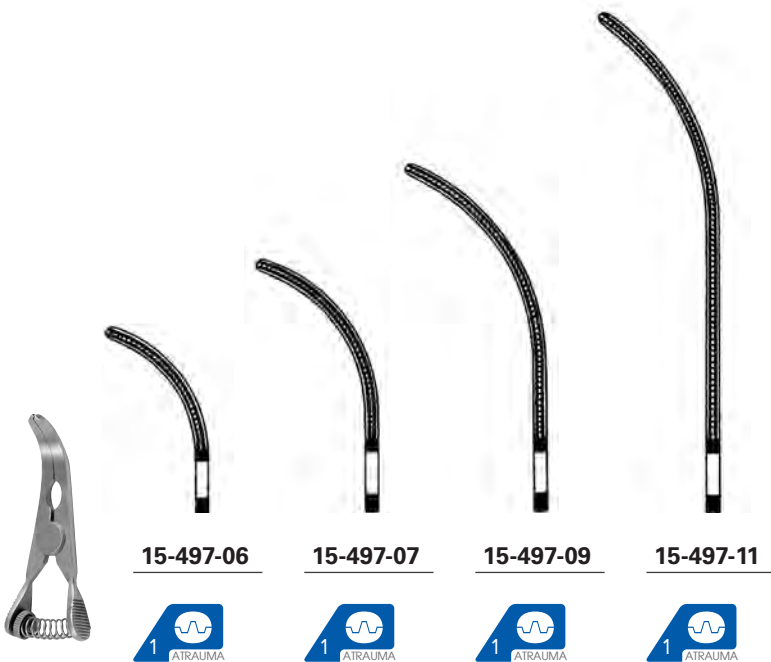
**15-496-07**

**15-496-10**

**15-496-12**

**GLOVER**

<b>15-496-06</b>	60,0 mm
<b>15-496-07</b>	68,0 mm
<b>15-496-10</b>	96,0 mm
<b>15-496-12</b>	117,0 mm



**15-497-06**

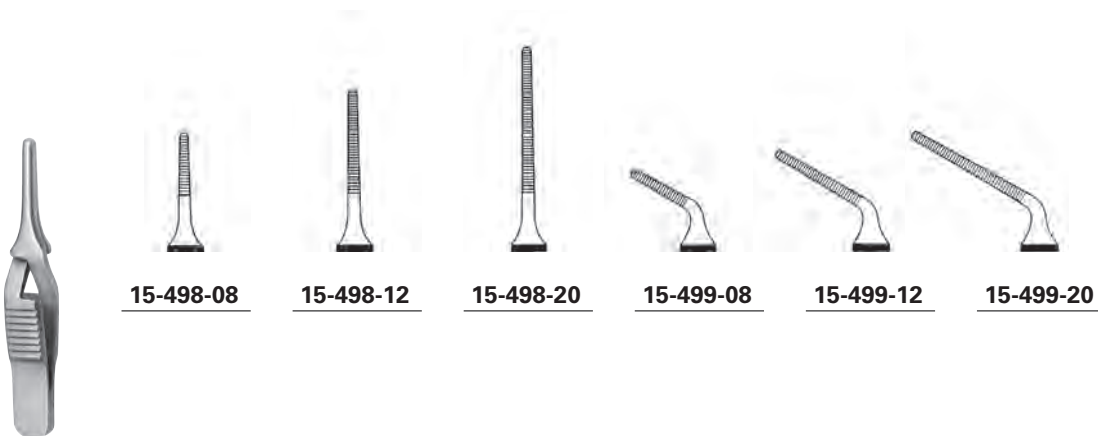
**15-497-07**

**15-497-09**

**15-497-11**

**GLOVER**

<b>15-497-06</b>	55,0 mm
<b>15-497-07</b>	65,0 mm
<b>15-497-09</b>	91,0 mm
<b>15-497-11</b>	110,0 mm

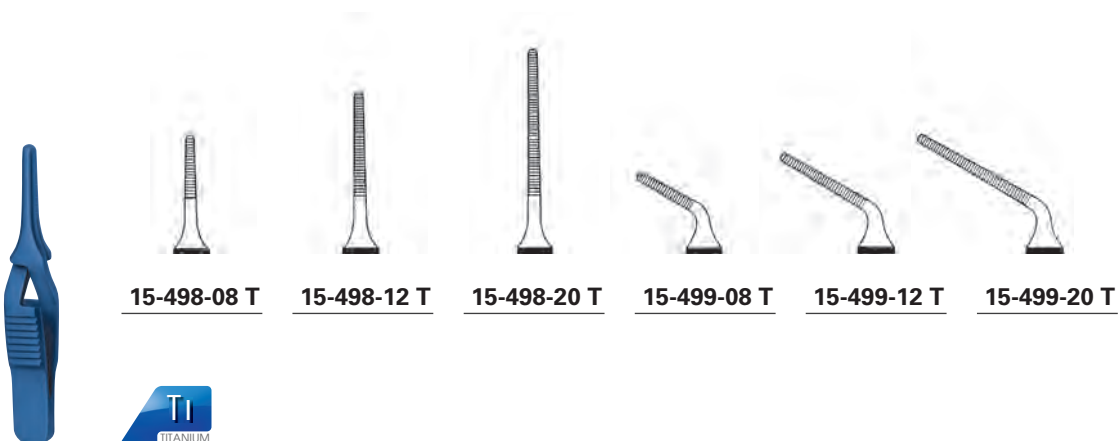


## DIETHRICH

**15-498-08 - 15-499-08** 8,0 mm

**15-498-12 - 15-499-12** 12,0 mm

**15-498-20 - 15-499-20** 20,0 mm

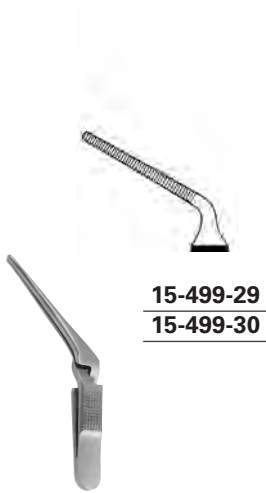


## DIETHRICH

**15-498-08 T - 15-499-08 T** 8,0 mm

**15-498-12 T - 15-499-12 T** 12,0 mm

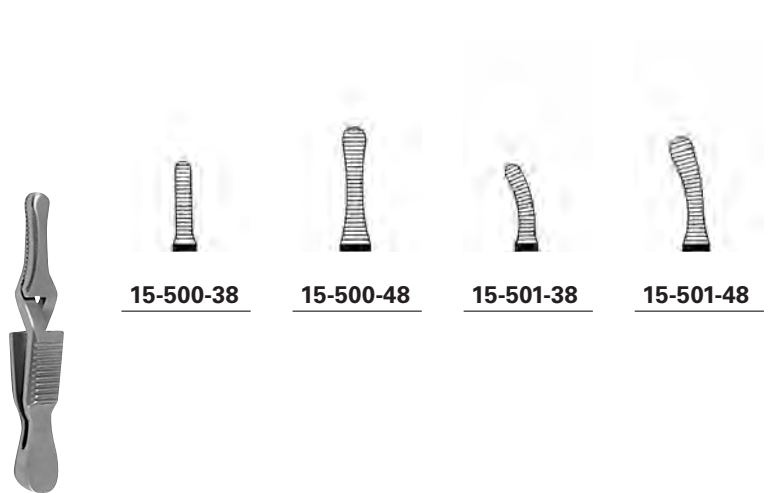
**15-498-20 T - 15-499-20 T** 20,0 mm



**15-499-29**  
**15-499-30**

**HESS**

<b>15-499-29</b>	20,0 mm
<b>15-499-30</b>	30,0 mm



**15-500-38**

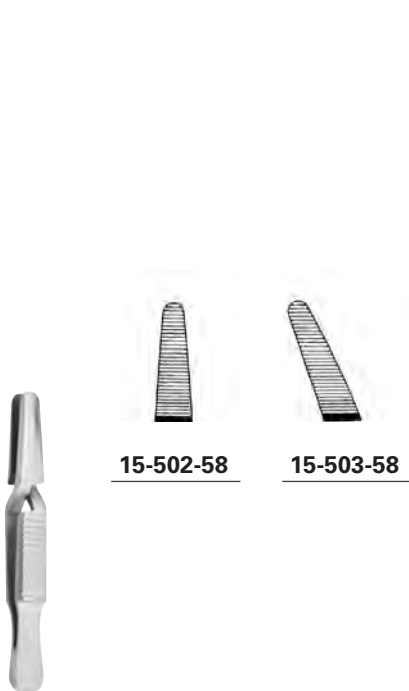
**15-500-48**

**15-501-38**

**15-501-48**

**DIEFFENBACH**

<b>15-500-38 - 15-501-38</b>	38,0 mm
<b>15-500-48 - 15-501-48</b>	48,0 mm

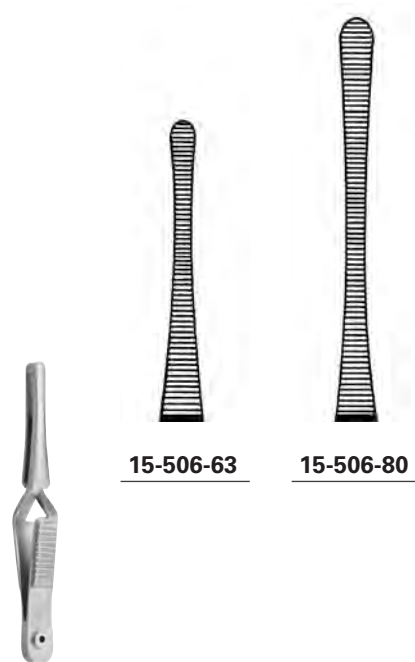


**15-502-58**

**15-503-58**

**DIEFFENBACH**

<b>15-502-58 - 15-503-58</b>	58,0 mm
------------------------------	---------



**15-506-63**

**15-506-80**

**JOHN-HOPKINS**

<b>15-506-63</b>	63,0 mm
<b>15-506-80</b>	80,0 mm



**15-505-38**



**15-505-48**



**15-505-56**



**15-505-63**



**15-505-70**



**15-505-80**



**15-505-91**



## JOHN-HOPKINS

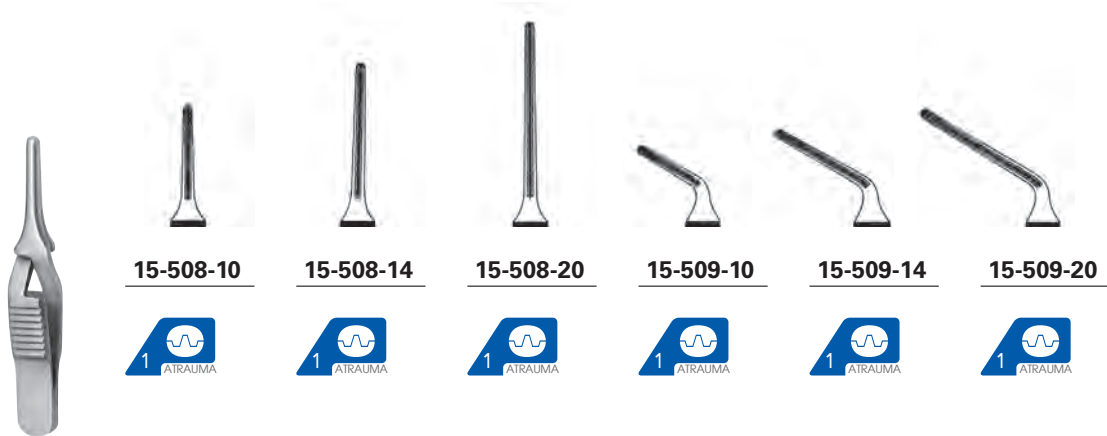
<b>15-505-38</b>	38,0 mm
<b>15-505-48</b>	48,0 mm
<b>15-505-56</b>	56,0 mm
<b>15-505-63</b>	63,0 mm
<b>15-505-70</b>	70,0 mm
<b>15-505-80</b>	80,0 mm
<b>15-505-91</b>	91,0 mm



Anlegezange für Bulldogklemmen  
 15-494-08 - 15-495-11 & 15-505-38 - 15-506-80  
 Applying forceps for bulldog clamps  
 15-494-08 - 15-495-11 & 15-505-38 - 15-506-80  
 Pinza para poner los clamps bulldog  
 15-494-08 - 15-495-11 & 15-505-38 - 15-506-80  
 Pinza per applicare le pinze bulldog  
 15-494-08 - 15-495-11 & 15-505-38 - 15-506-80

## JOHN-HOPKINS

**15-507-24** 24,0 cm, 9 1/2 "

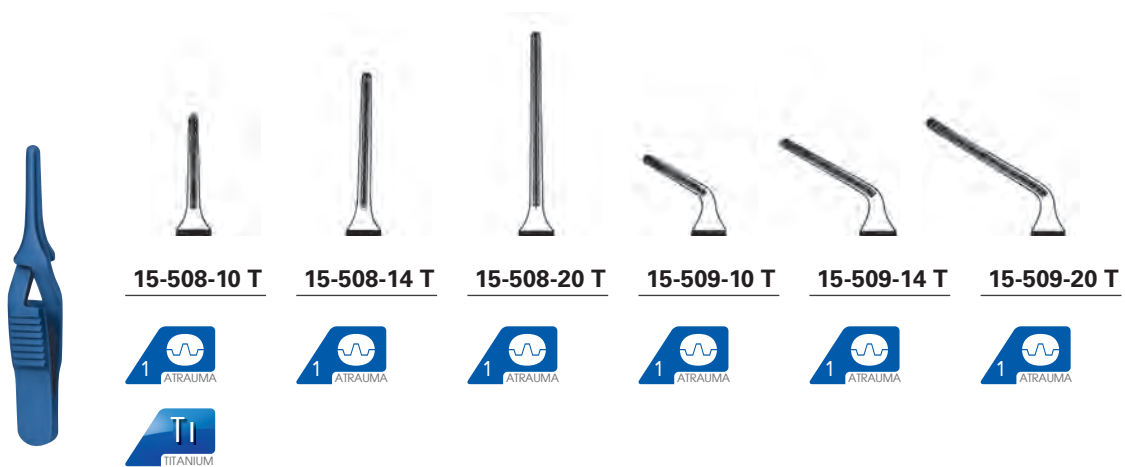


### DE BAKEY-DIETRICH

**15-508-10 - 15-509-10** 10,0 mm

**15-508-14 - 15-509-14** 14,0 mm

**15-508-20 - 15-509-20** 20,0 mm



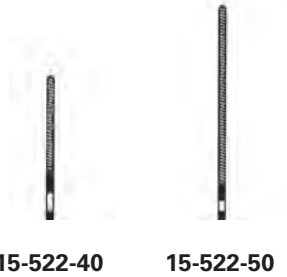
### DE BAKEY-DIETRICH

**15-508-10 T - 15-509-10 T** 10,0 mm

**15-508-14 T - 15-509-14 T** 14,0 mm

**15-508-20 T - 15-509-20 T** 20,0 mm





### VENA

<b>15-522-30</b>	30,0 mm
<b>15-522-35</b>	35,0 mm
<b>15-522-40</b>	40,0 mm
<b>15-522-50</b>	50,0 mm

### ARTERIA

<b>15-526-30</b>	30,0 mm
<b>15-526-35</b>	35,0 mm
<b>15-526-40</b>	40,0 mm
<b>15-526-50</b>	50,0 mm



### VENA

<b>15-523-30</b>	30,0 mm
<b>15-523-35</b>	35,0 mm
<b>15-523-40</b>	40,0 mm
<b>15-523-50</b>	50,0 mm

### ARTERIA

<b>15-527-30</b>	30,0 mm
<b>15-527-35</b>	35,0 mm
<b>15-527-40</b>	40,0 mm
<b>15-527-50</b>	50,0 mm



**VENA**

<b>15-525-30</b>	30,0 mm
<b>15-525-35</b>	35,0 mm
<b>15-525-40</b>	40,0 mm
<b>15-525-50</b>	50,0 mm

**ARTERIA**

<b>15-529-30</b>	30,0 mm
<b>15-529-35</b>	35,0 mm
<b>15-529-40</b>	40,0 mm
<b>15-529-50</b>	50,0 mm



**15-530-24** 24,0 cm, 9 1/2"

Anlege- und Entfernungszange für TITAN Bulldogklemmen 15-522-30 - 15-529-50  
 Applying and removing forceps for TITANIUM bulldog clamps 15-522-30 - 15-529-50  
 Pinza para poner y quitar TITANIUM clamps bulldog 15-522-30 - 15-529-50  
 Pinze metti-rimuovi TITANIUM clamps bulldog 15-522-30 - 15-529-50



**15-531-05**



**GLOVER**

**15-531-05** 50,0 mm



**15-533-07**



**SANTULLI**

**15-533-07** 70,0 mm





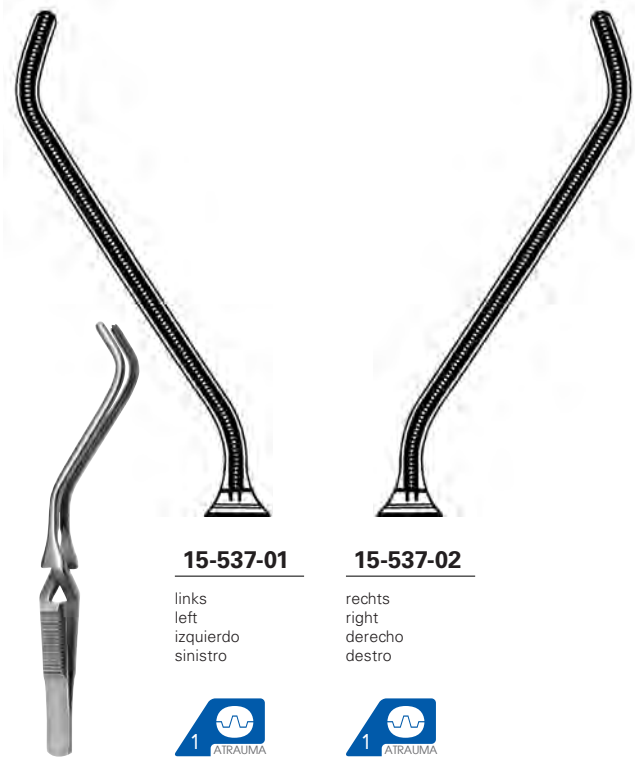
**15-535-09**

**15-535-11**



**GREGORY-SOFT**

**15-535-09** 90,0 mm  
**15-535-11** 110,0 mm



**15-537-01**

**15-537-02**

links  
 left  
 izquierdo  
 sinistro

rechts  
 right  
 derecho  
 destro



**GREGORY-SOFT**

**15-537-01 - 15-537-02** 110,0 mm



**15-539-07**



**DE BAKEY-SATINSKY**

**15-539-07** 70,0 mm

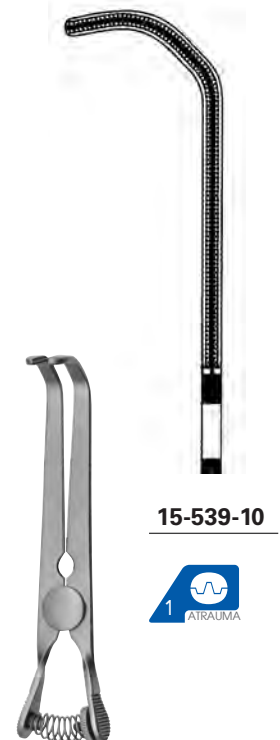


**15-539-09**



**DE BAKEY-CAROTIS**

**15-539-09** 90,0 mm

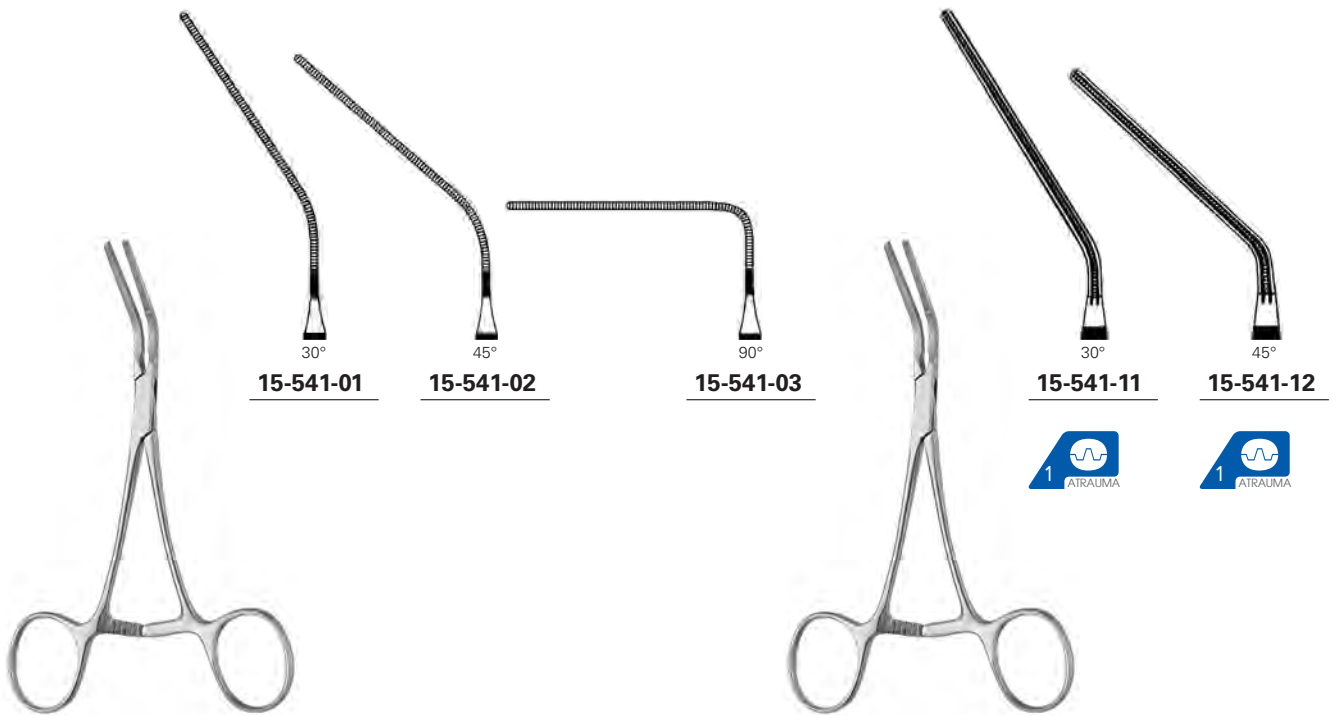


**15-539-10**



**DE BAKEY-SATINSKY**

**15-539-10** 100,0 mm

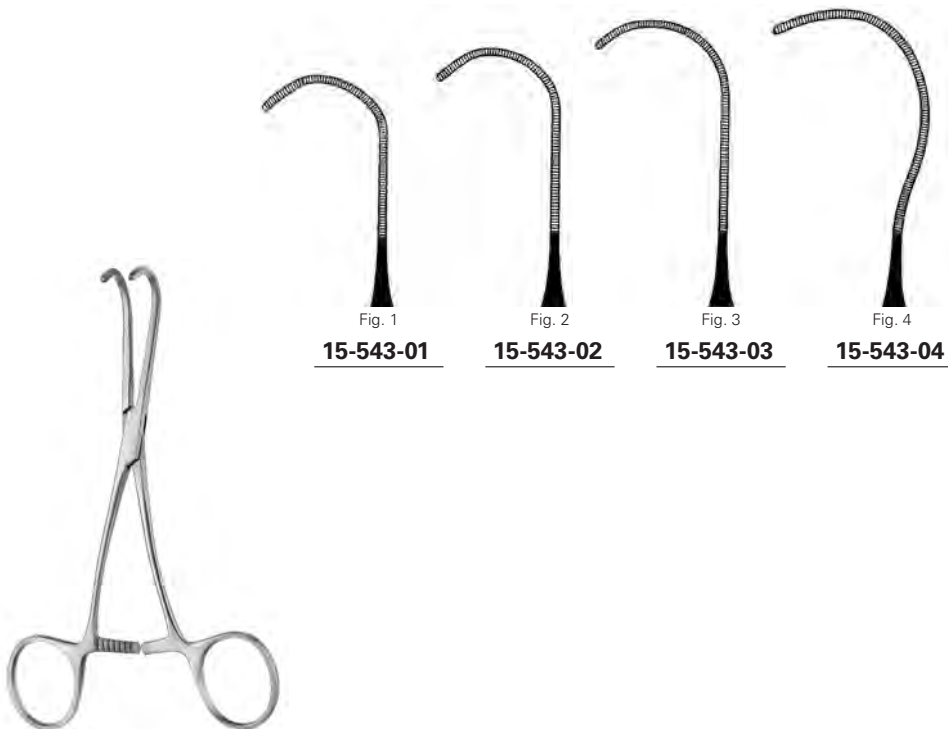


**CASTANEDA**

<b>15-541-01</b>	12,5 cm, 5 "
<b>15-541-02</b>	11,5 cm, 4 ½ "
<b>15-541-03</b>	11,0 cm, 4 ¾ "

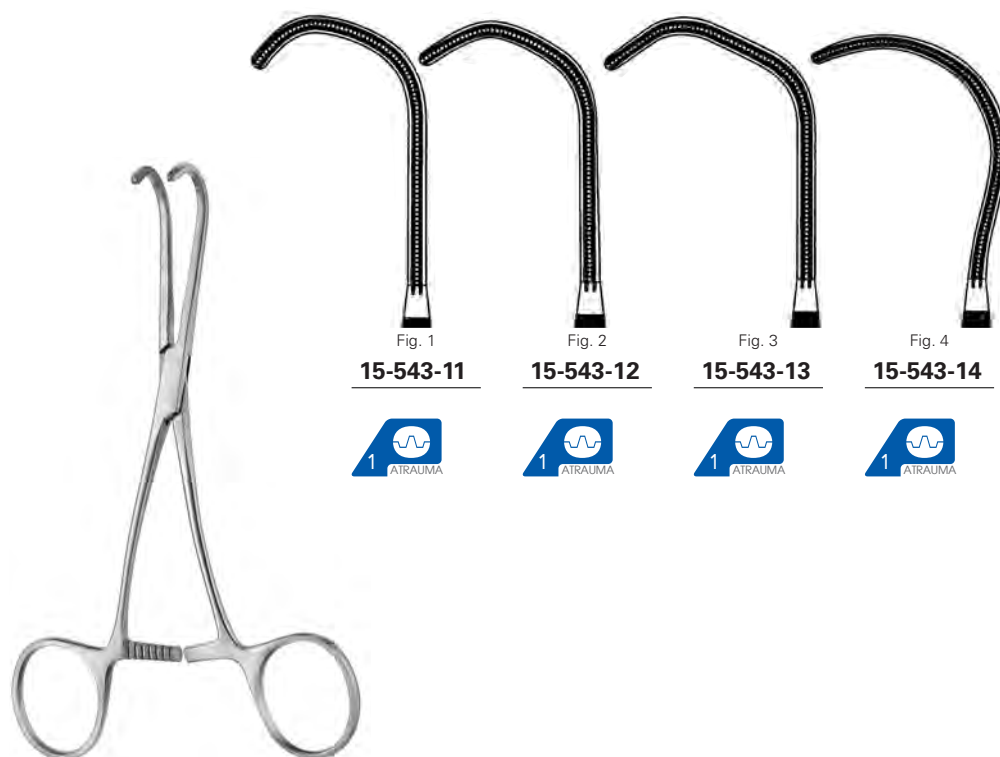
**CASTANEDA**

<b>15-541-11</b>	12,0 cm, 4 ¾ "
<b>15-541-12</b>	12,0 cm, 4 ¾ "



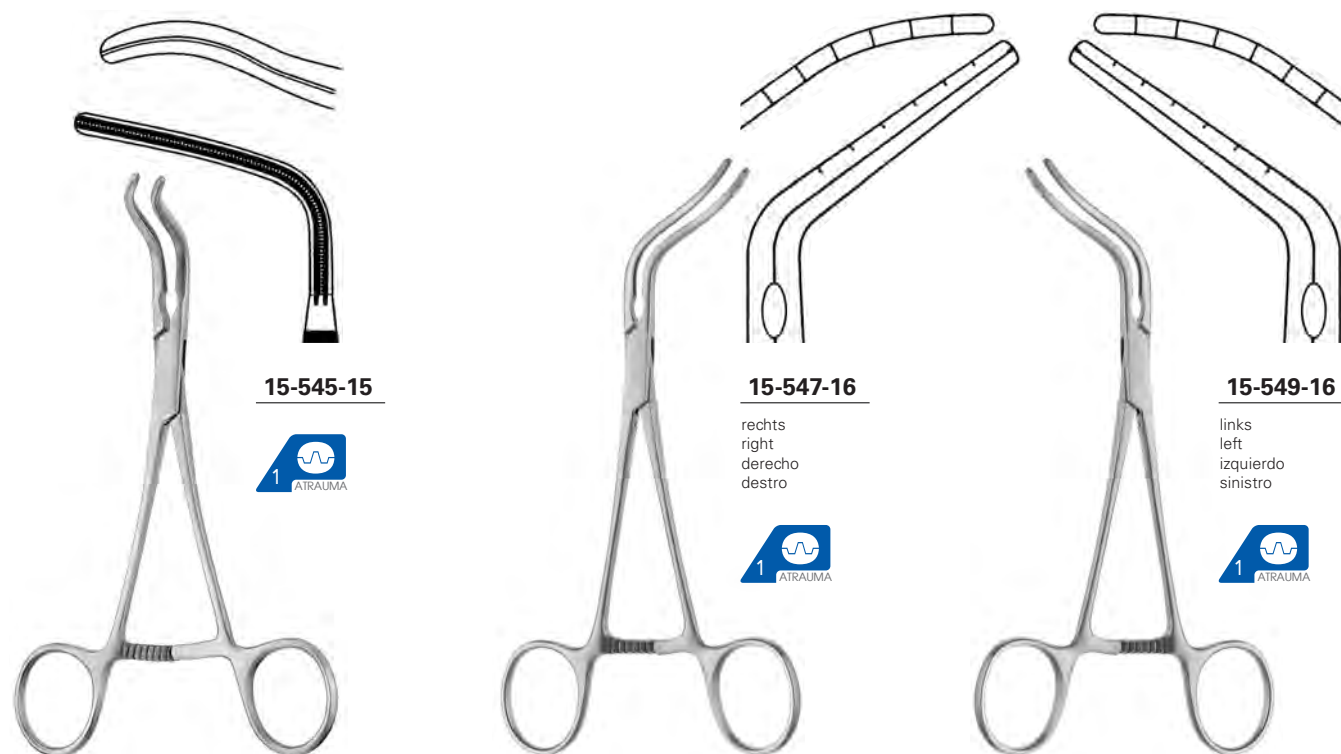
**CASTANEDA**

<b>15-543-01</b>	11,5 cm, 4 ½ "
<b>15-543-02 - 15-543-04</b>	12,0 cm, 4 ¾ "



### CASTANEDA

**15-543-11 - 15-543-14** 15,5 cm, 6 1/8 "



### SUBRAMANIAN

**15-545-15** 15,5 cm, 6 1/8 "

### SUBRAMANIAN

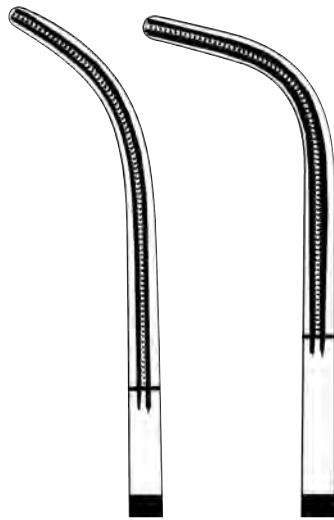
**15-547-16** 16,0 cm, 6 1/4 "

### SUBRAMANIAN

**15-549-16** 16,0 cm, 6 1/4 "



15-551-24



15-551-25



**DE BAKEY-RUMEL**

15-551-24 24,5 cm, 9 <sup>2</sup>/<sub>3</sub> "

15-551-25 25,0 cm, 9 <sup>3</sup>/<sub>4</sub> "



15-551-28



**DE BAKEY-MIXTER**

15-551-28 28,5 cm, 11 <sup>1</sup>/<sub>4</sub> "



15-552-21



**MC QUIGG-MIXTER**

15-552-21 21,0 cm, 8 <sup>1</sup>/<sub>4</sub> "



15-554-12



15-555-11



**DE BAKEY**

15-554-12 13,0 cm, 5 <sup>1</sup>/<sub>8</sub> "

15-555-11 12,5 cm, 5 "



90°  
**15-557-10**



**DE BAKEY**

**15-557-10** 10,0 cm, 4"

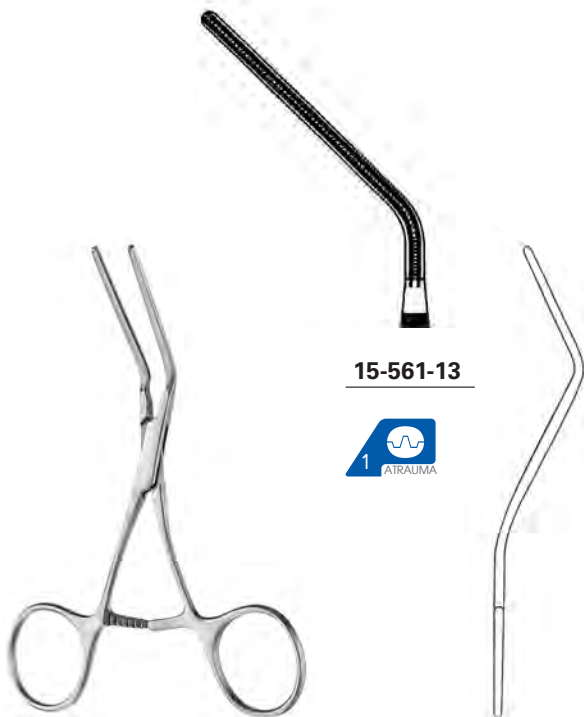


**15-559-12**



**DE BAKEY**

**15-559-12** 12,5 cm, 5"



**15-561-13**



**DE BAKEY**

**15-561-13** 12,5 cm, 5"

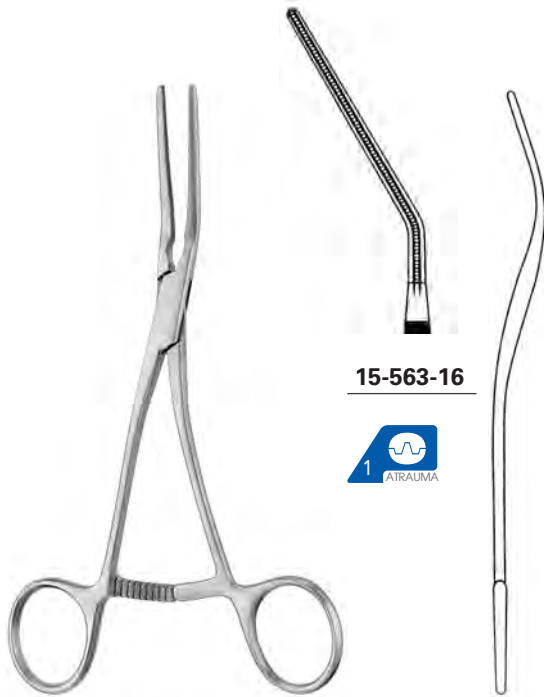


**15-562-17**



**DE BAKEY**

**15-562-17** 17,0 cm, 6 3/4"

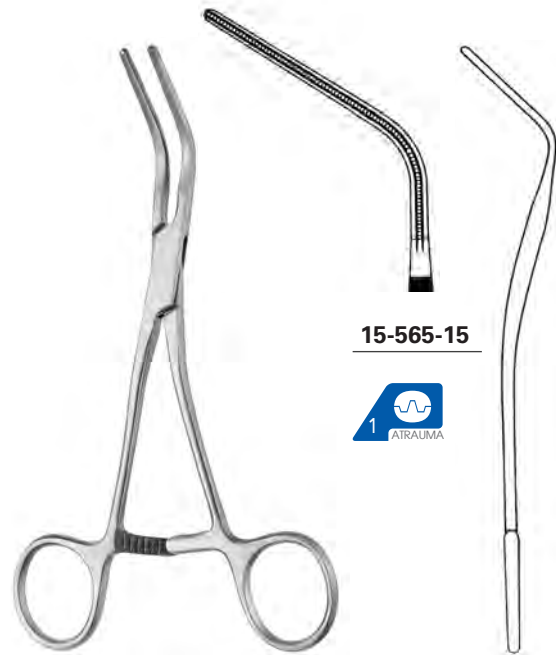


**15-563-16**



**DE BAKEY**

**15-563-16** 16,5 cm, 6 ½"



**15-565-15**



**DE BAKEY**

**15-565-15** 16,0 cm, 6 ¼"



**15-567-15**



**DE BAKEY**

**15-567-15** 15,0 cm, 6"



**15-569-17**



**DE BAKEY**

**15-569-17** 16,5 cm, 6 ½"





**15-571-17**



**GLOVER**

**15-571-17** 17,0 cm, 6 3/4 "



**15-573-17**



**GLOVER**

**15-573-17** 17,5 cm, 7 "



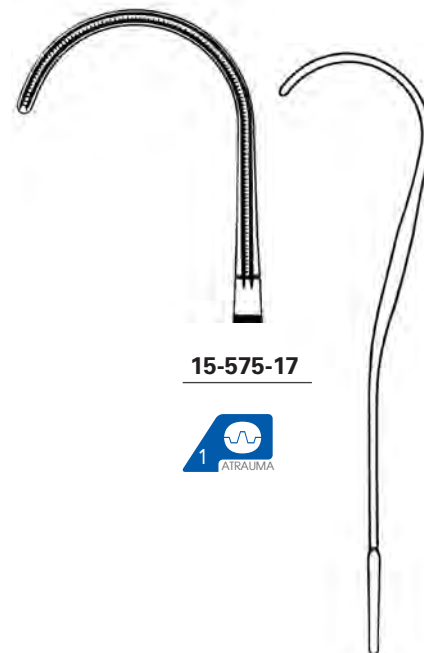
**15-575-16**



**DE BAKEY**

**15-575-16** 16,0 cm, 6 1/2 "

**15-575-17** 17,0 cm, 6 3/4 "



**15-575-17**





15-577-16

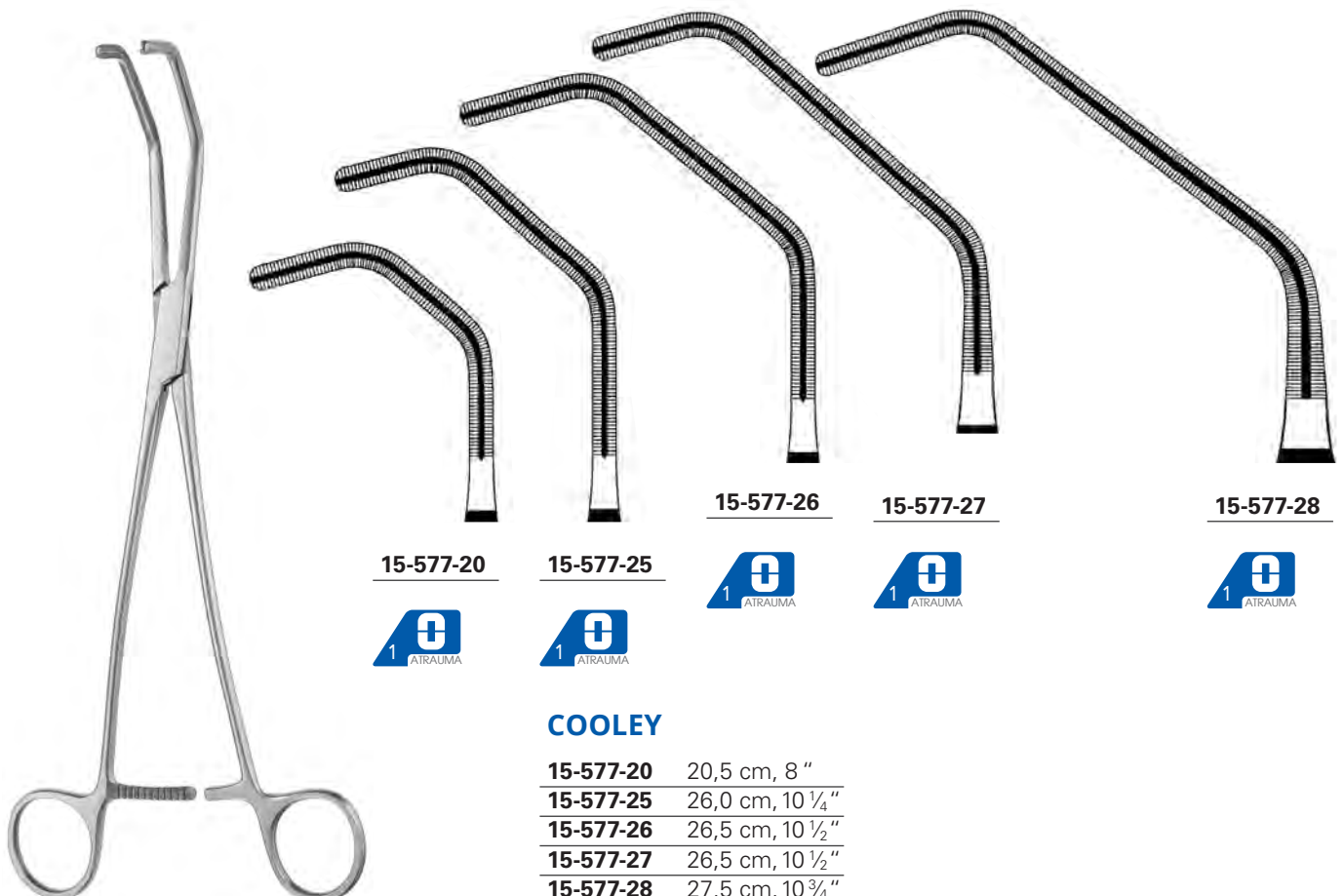
15-577-17

15-577-18



### DERRA

15-577-16	16,5 cm, 6 1/2"
15-577-17	17,0 cm, 6 3/4"
15-577-18	18,0 cm, 7"



15-577-20

15-577-25

15-577-26

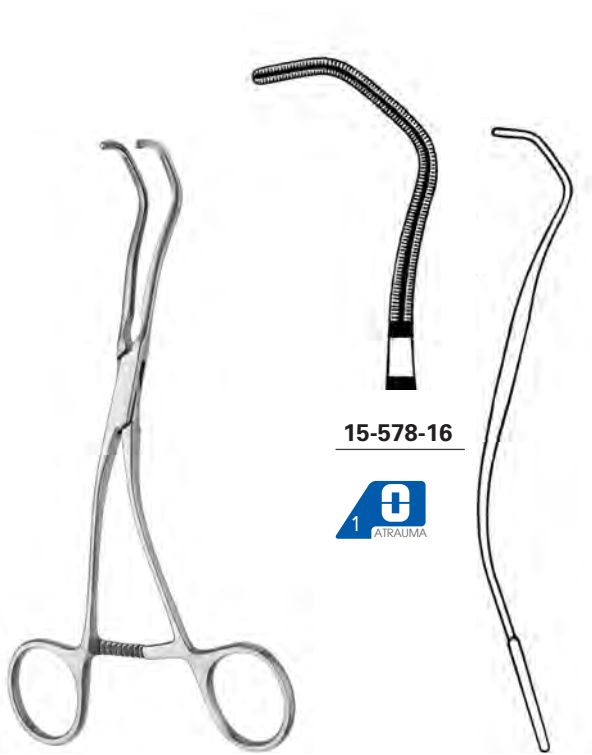
15-577-27

15-577-28



### COOLEY

15-577-20	20,5 cm, 8"
15-577-25	26,0 cm, 10 1/4"
15-577-26	26,5 cm, 10 1/2"
15-577-27	26,5 cm, 10 1/2"
15-577-28	27,5 cm, 10 3/4"



15-578-16



15-579-17

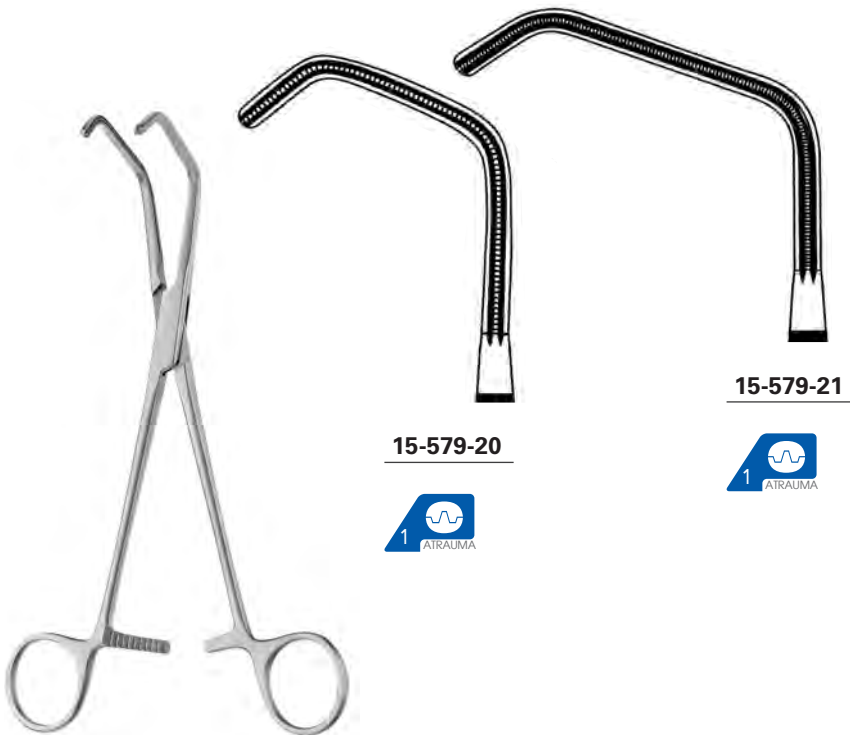


**COOLEY**

15-578-16 16,0 cm, 6 ¼"

**DE BAKEY-BECK**

15-579-17 17,0 cm, 6 ¾"



15-579-20



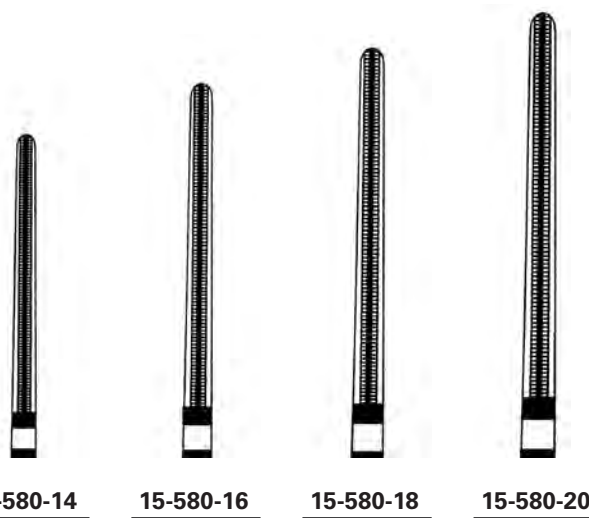
15-579-21



**DE BAKEY-BECK**

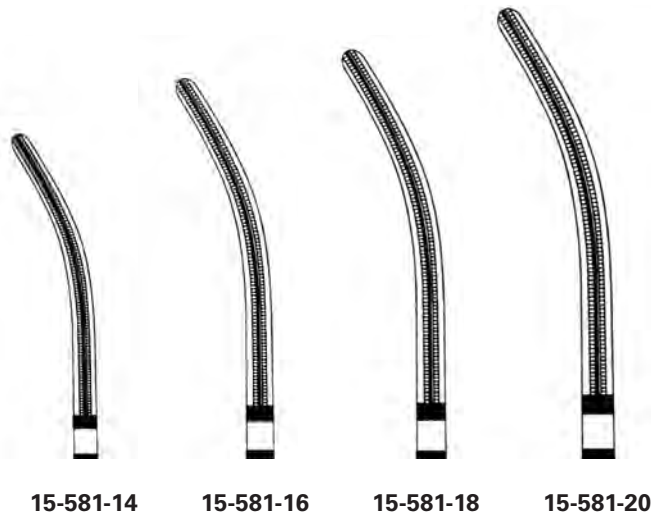
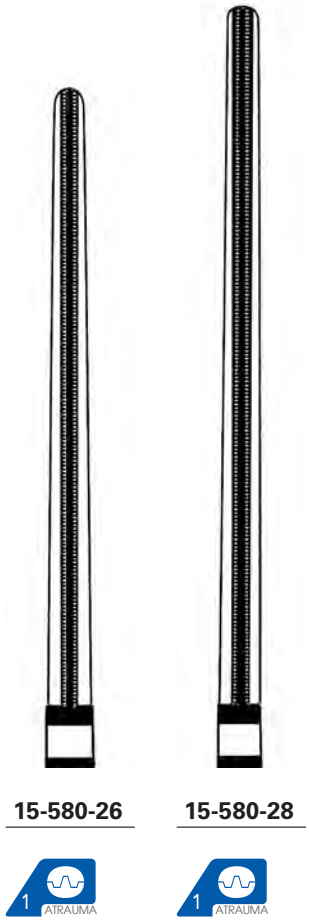
15-579-20 20,5 cm, 8"

15-579-21 21,0 cm, 8 ¼"



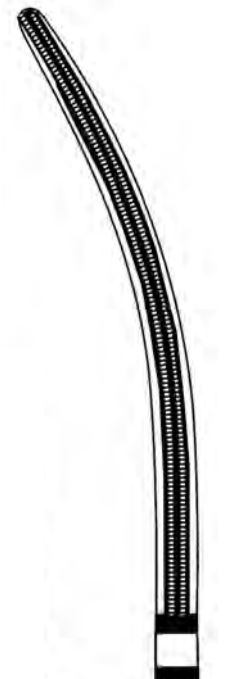
**DE BAKEY-PEAN**

<b>15-580-14</b>	14,0 cm, 5 1/2 "
<b>15-580-16</b>	16,0 cm, 6 1/4 "
<b>15-580-18</b>	18,0 cm, 7 "
<b>15-580-20</b>	20,0 cm, 8 "
<b>15-580-26</b>	26,0 cm, 10 1/4 "
<b>15-580-28</b>	28,0 cm, 11 "



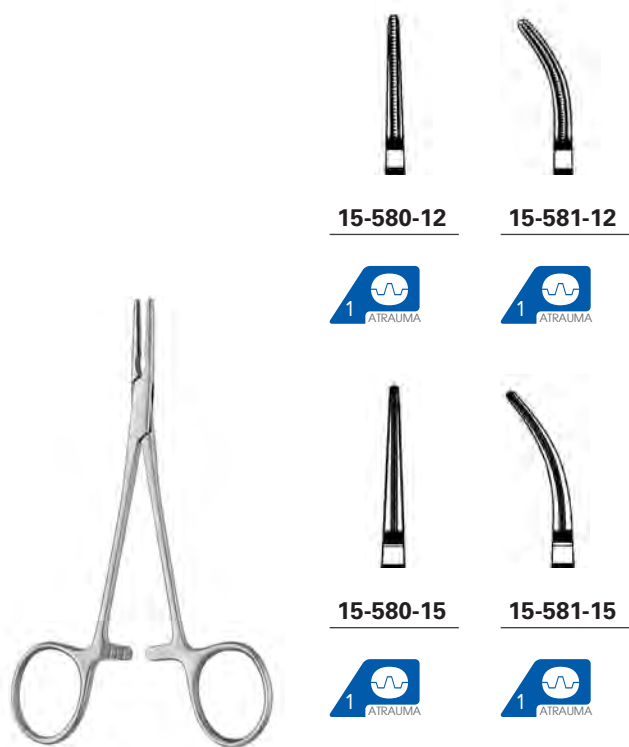
**DE BAKEY-PEAN**

<b>15-581-14</b>	14,0 cm, 5 1/2 "
<b>15-581-16</b>	16,0 cm, 6 1/4 "
<b>15-581-18</b>	18,0 cm, 7 "
<b>15-581-20</b>	20,0 cm, 8 "
<b>15-581-28</b>	28,0 cm, 11 "



**15-581-28**





### DE BAKEY-MOSQUITO

**15-580-12 - 15-581-12** 12,5 cm, 5"  
**15-580-15 - 15-581-15** 15,5 cm, 6 1/8"



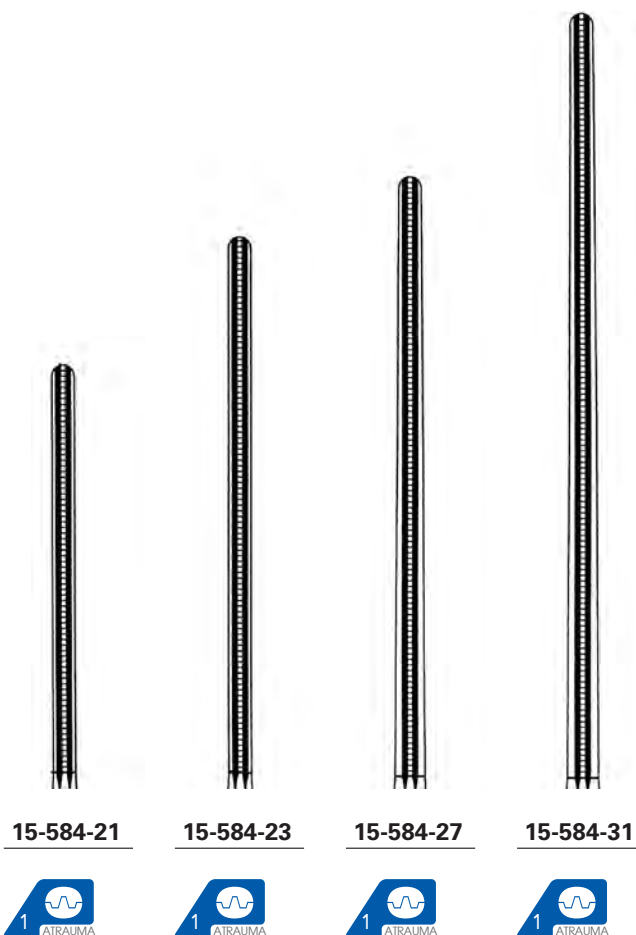
### DE BAKEY-RANKIN

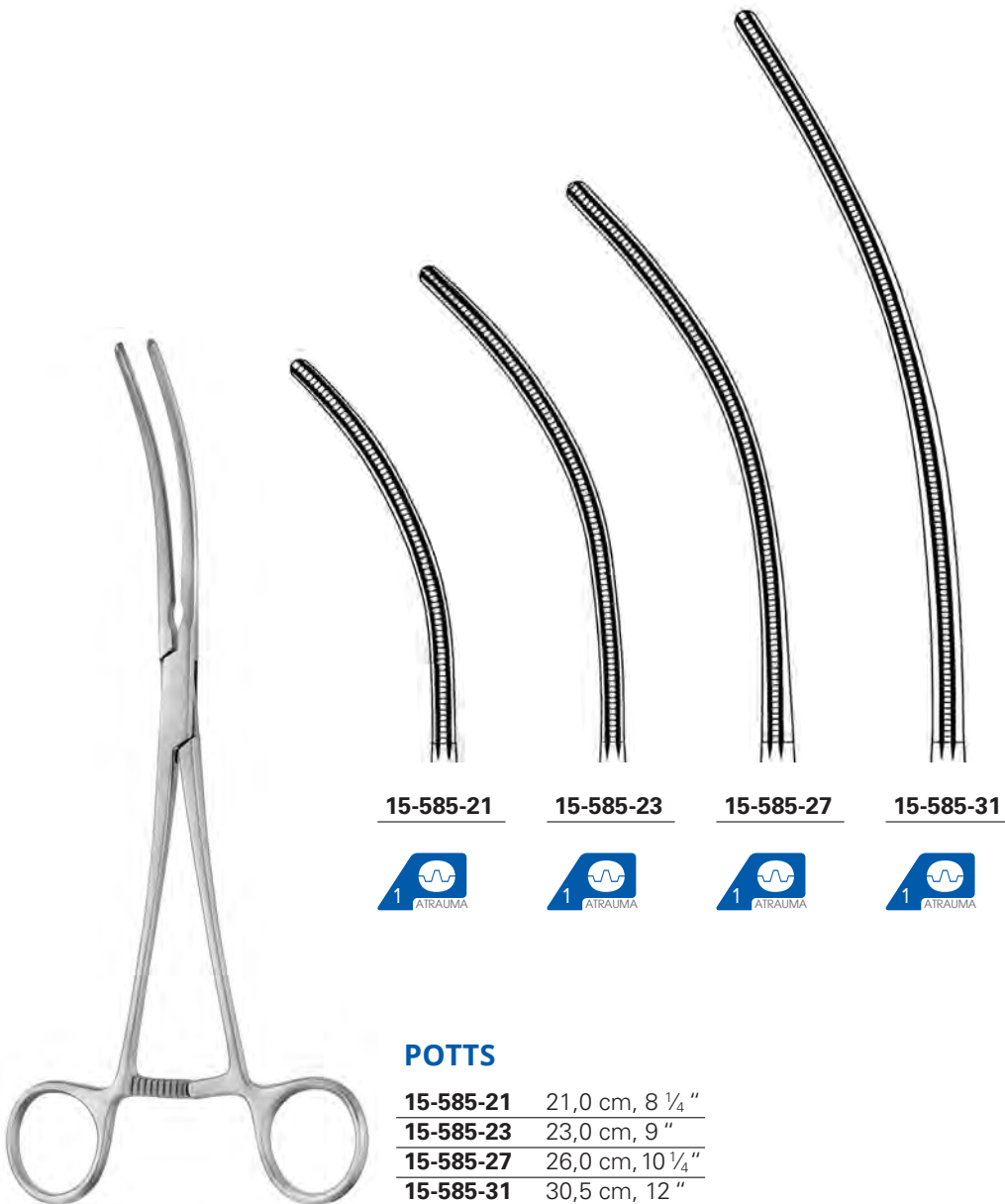
**15-582-16 - 15-583-16** 16,0 cm, 6 1/4"



### POTTS

**15-584-21** 21,5 cm, 8 1/2"  
**15-584-23** 23,5 cm, 9 1/4"  
**15-584-27** 27,0 cm, 10 3/4"  
**15-584-31** 31,0 cm, 12 1/4"





**15-585-21**



**15-585-23**



**15-585-27**



**15-585-31**



### POTTS

**15-585-21** 21,0 cm, 8 ¼"

**15-585-23** 23,0 cm, 9"

**15-585-27** 26,0 cm, 10 ¼"

**15-585-31** 30,5 cm, 12"



**15-587-25**



**15-587-27**



**15-587-30**



**15-587-31**



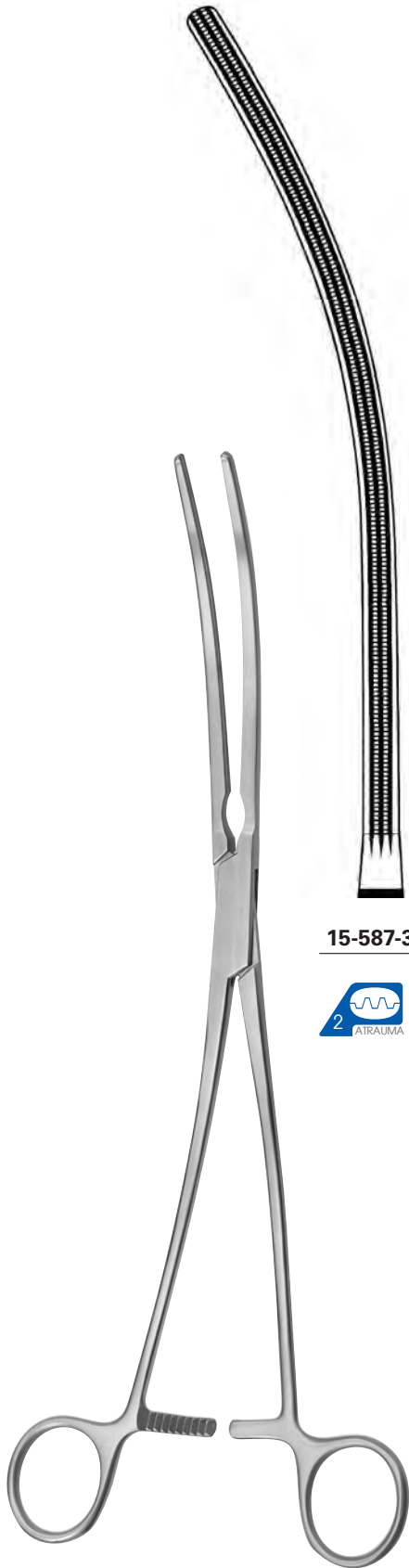
**15-587-33**



**DE BAKEY**

<b>15-587-25</b>	25,0 cm, 9 3/4 "
<b>15-587-27</b>	27,0 cm, 10 3/4 "
<b>15-587-30</b>	30,0 cm, 11 3/4 "
<b>15-587-31</b>	31,0 cm, 12 1/4 "
<b>15-587-33</b>	33,0 cm, 13 "



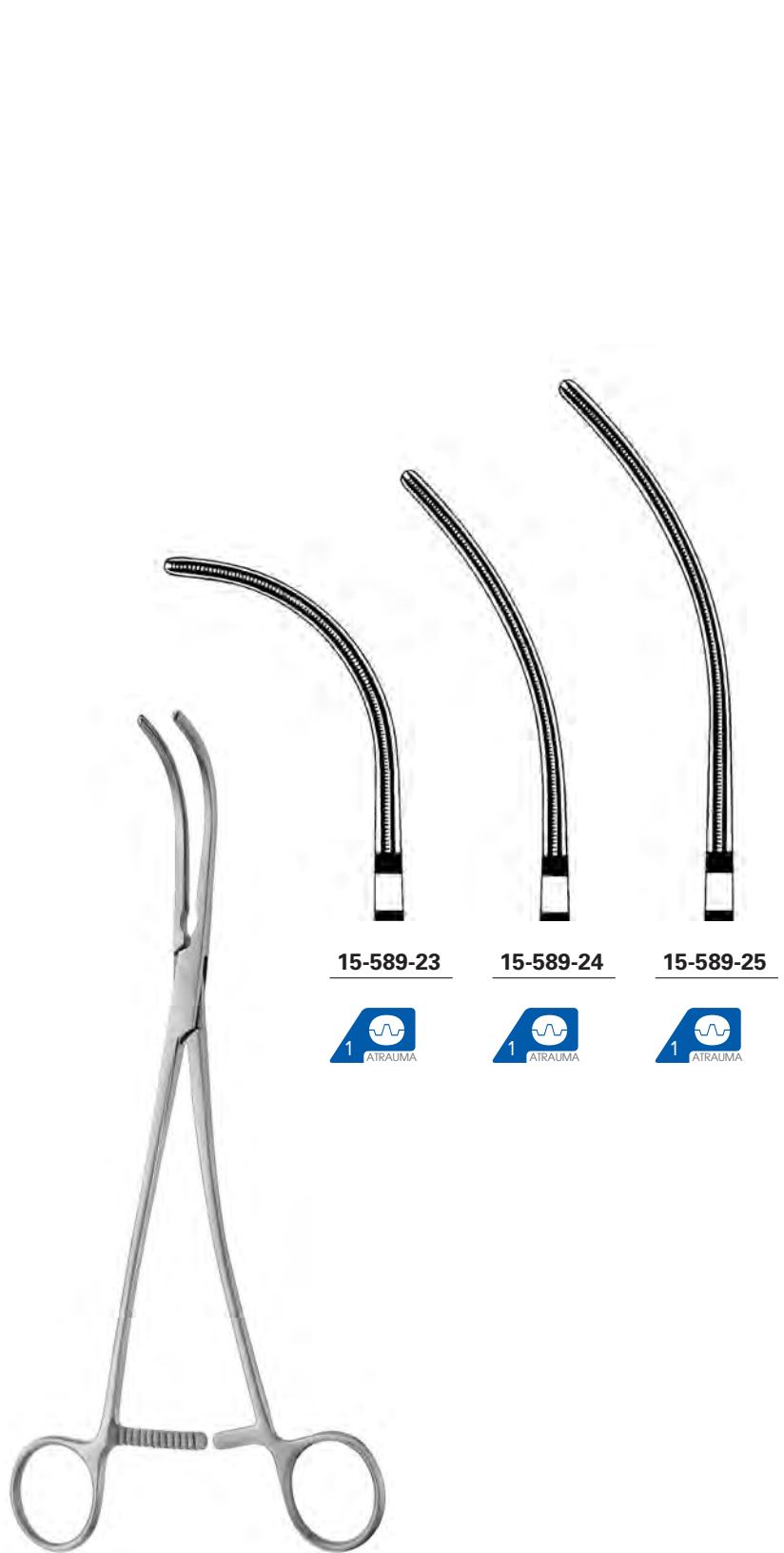


15-587-34



**DE BAKEY**

15-587-34 33,0 cm, 13 "



15-589-23



15-589-24



15-589-25



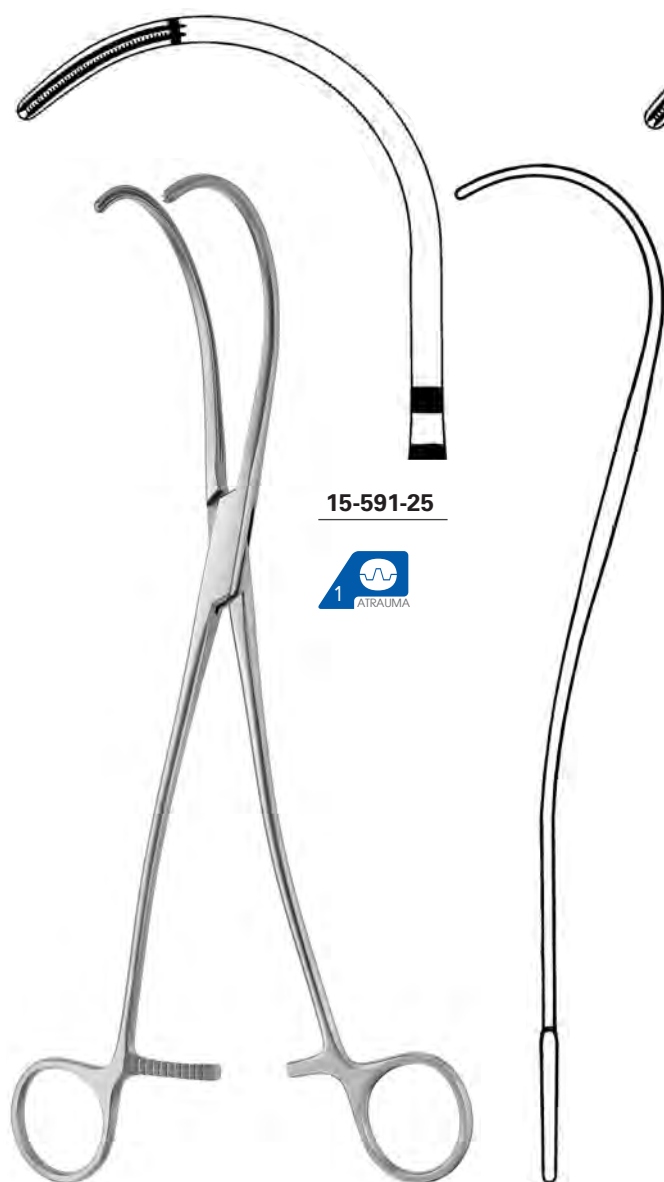
**DE BAKEY-BAHNSON**

15-589-23 23,5 cm, 9 ¼ "

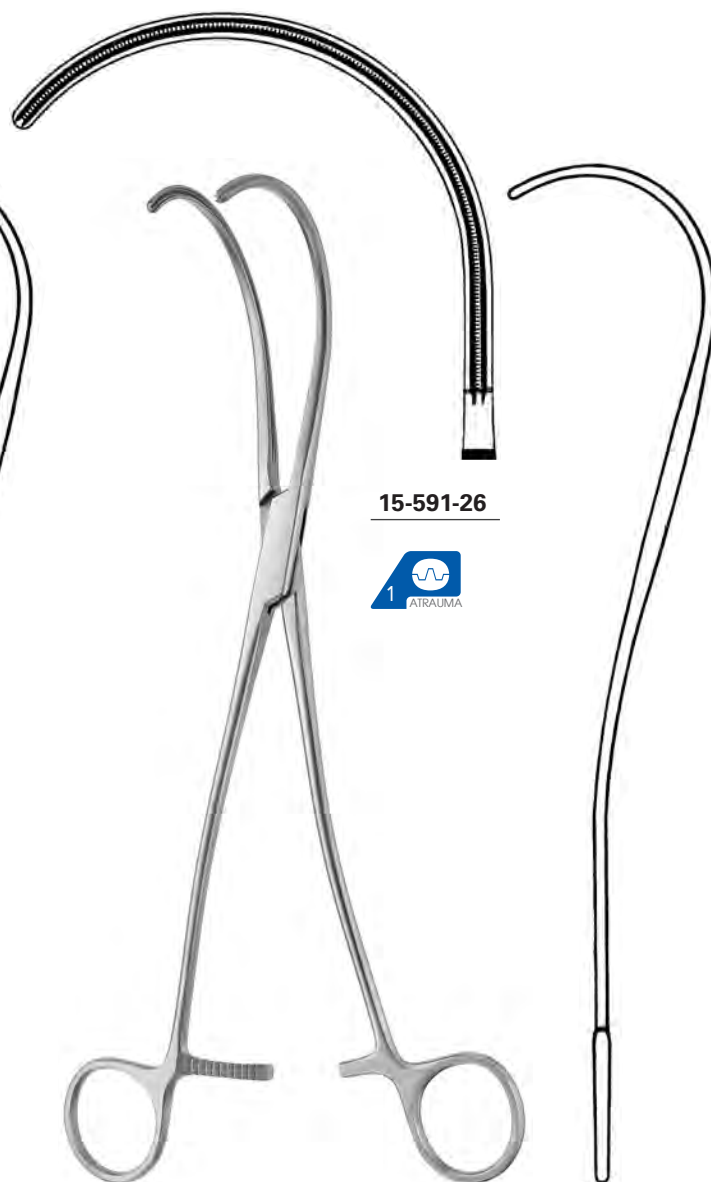
15-589-24 24,5 cm, 9 ⅔ "

15-589-25 25,5 cm, 10 "





15-591-25



15-591-26



**DE BAKEY**

**15-591-25** 27,0 cm, 10<sup>3</sup>/<sub>4</sub>"

**DE BAKEY**

**15-591-26** 27,0 cm, 10<sup>3</sup>/<sub>4</sub>"



**15-593-01**



**WEBER**

**15-593-01** 26,0 cm, 10 ¼"



**15-593-02**



**WEBER**

**15-593-02** 26,0 cm, 10 ¼"

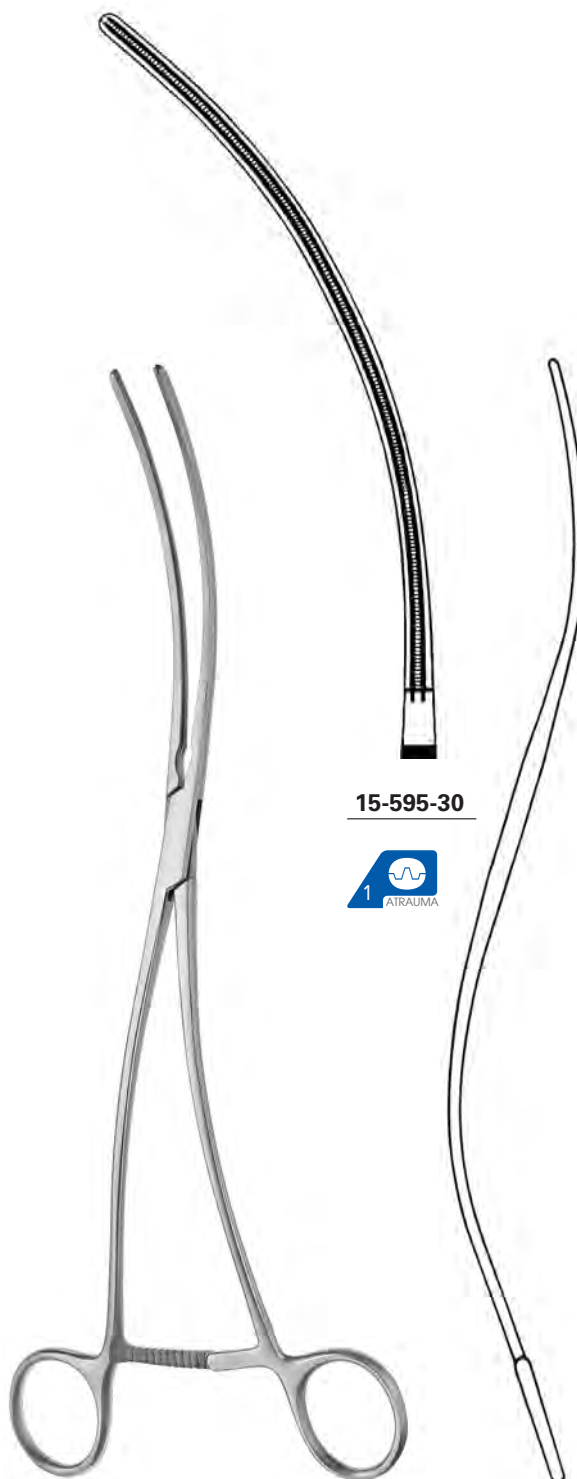


**15-595-28**



**DE BAKEY**

**15-595-28** 28,0 cm, 11 "



**15-595-30**



**DE BAKEY**

**15-595-30** 30,0 cm, 11 3/4 "



**15-596-15**



**15-596-18**



**15-597-15**



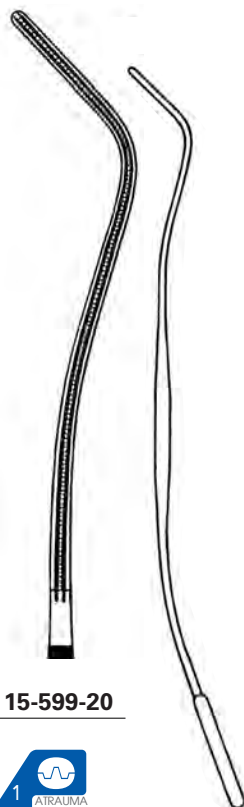
**15-597-18**



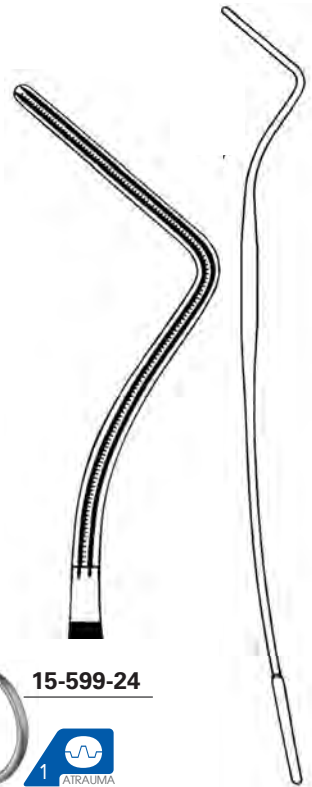
**BAINBRIDGE**

**15-596-15 - 15-597-15** 15,0 cm, 6"

**15-596-18 - 15-597-18** 18,5 cm, 7 ¼"



**15-599-20**



**15-599-24**



**DE BAKEY**

**15-599-20** 20,0 cm, 8"

**LEES**

**15-599-24** 24,0 cm, 9 ½"



**15-601-22**



**POTTS**

**15-601-22** 21,5 cm, 8 ½"



**15-601-24**

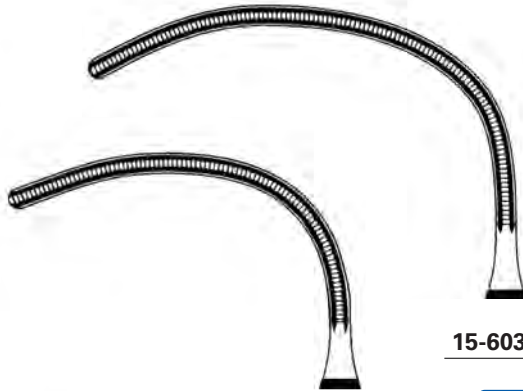


**GLOVER**

**15-601-24** 24,5 cm, 9 ⅔"



15-603-19



15-603-21



15-603-22



**GLOVER**

15-603-19 19,5 cm, 7 3/4"

15-603-21 21,0 cm, 8 1/4"

**GLOVER**

15-603-22 22,0 cm, 8 3/4"



15-605-19



15-605-21



15-605-23



15-605-24



**DE BAKEY**

15-605-19 19,0 cm, 7 1/2"

15-605-21 21,0 cm, 8 1/4"

15-605-23 - 15-605-24 23,0 cm, 9"

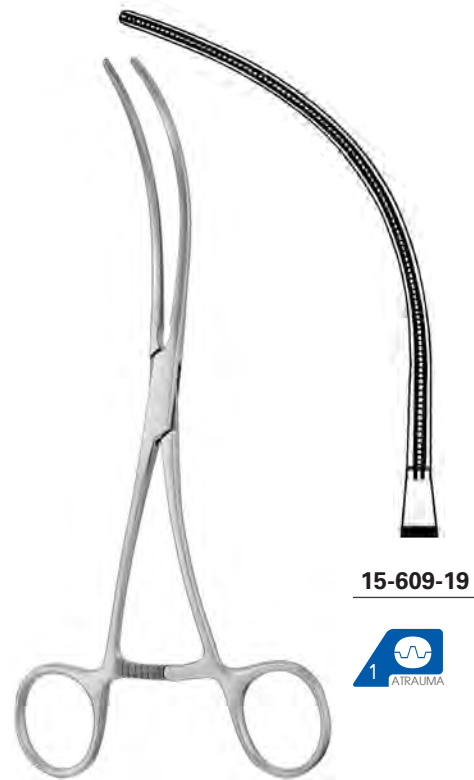


15-607-16



**DE BAKEY**

15-607-16 16,0 cm, 6 ¼"



15-609-19



**DE BAKEY**

15-609-19 19,0 cm, 7 ½"

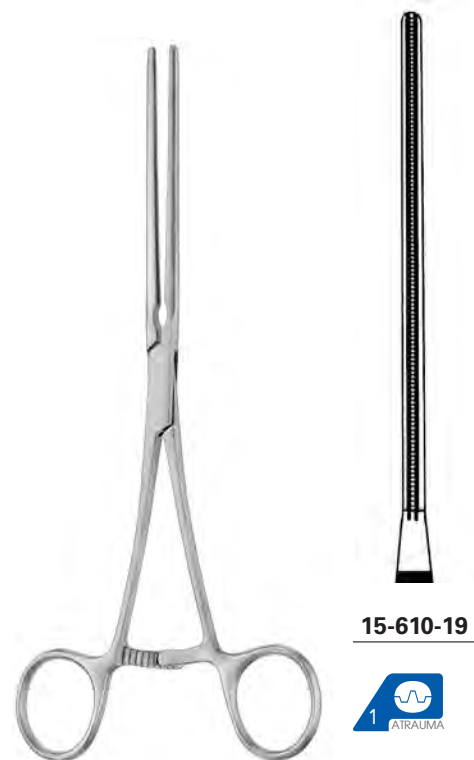


15-609-20



**DE BAKEY**

15-609-20 19,5 cm, 7 ¾"



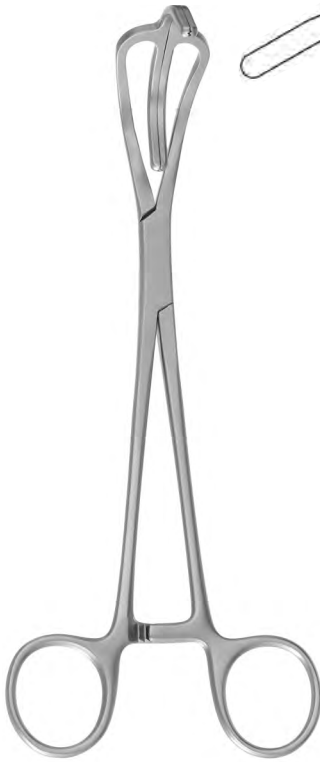
15-610-19



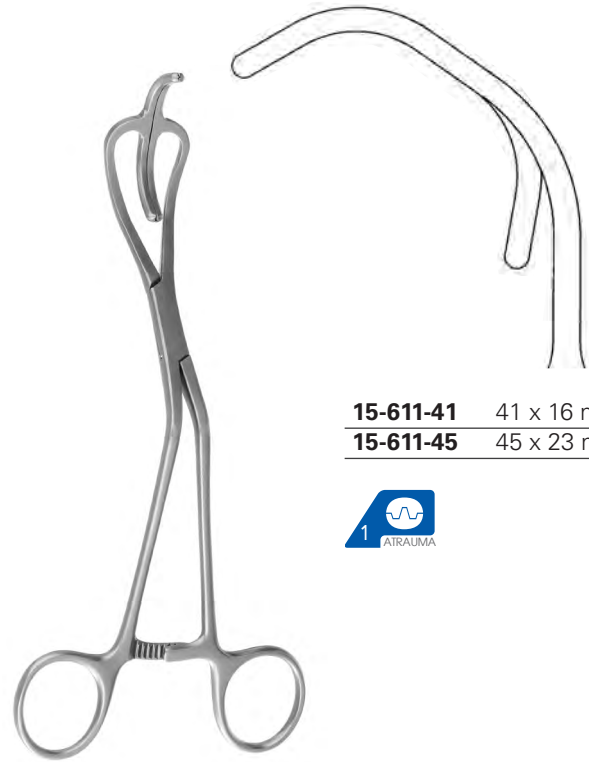
**LELAND-JONES**

15-610-19 19,0 cm, 7 ½"





**15-610-41** 41 x 16 mm  
**15-610-45** 45 x 23 mm



**15-611-41** 41 x 16 mm  
**15-611-45** 45 x 23 mm



**STRONG (COBRA)**

**15-610-41 - 15-610-45** 20,0 cm, 8"

**STRONG (COBRA)**

**15-611-41 - 15-611-45** 17,5 cm, 7"



**15-611-18**

**15-611-19**

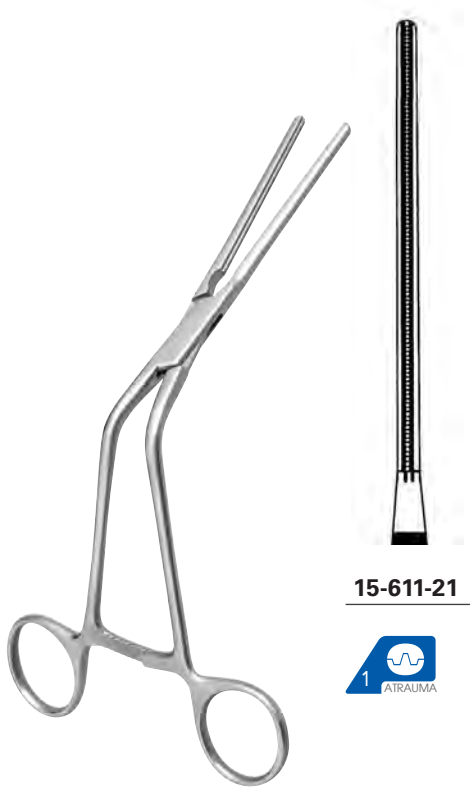
**15-611-20**



**LELAND-JONES**

**15-611-18** 18,0 cm, 7"  
**15-611-19** 18,5 cm, 7 1/4"  
**15-611-20** 19,5 cm, 7 3/4"

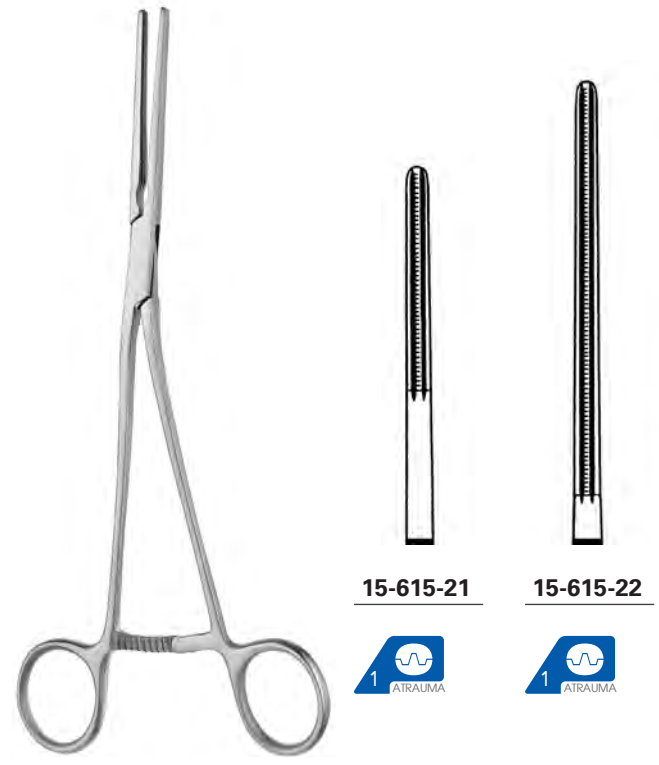






**15-611-21**  


**LELAND-JONES**

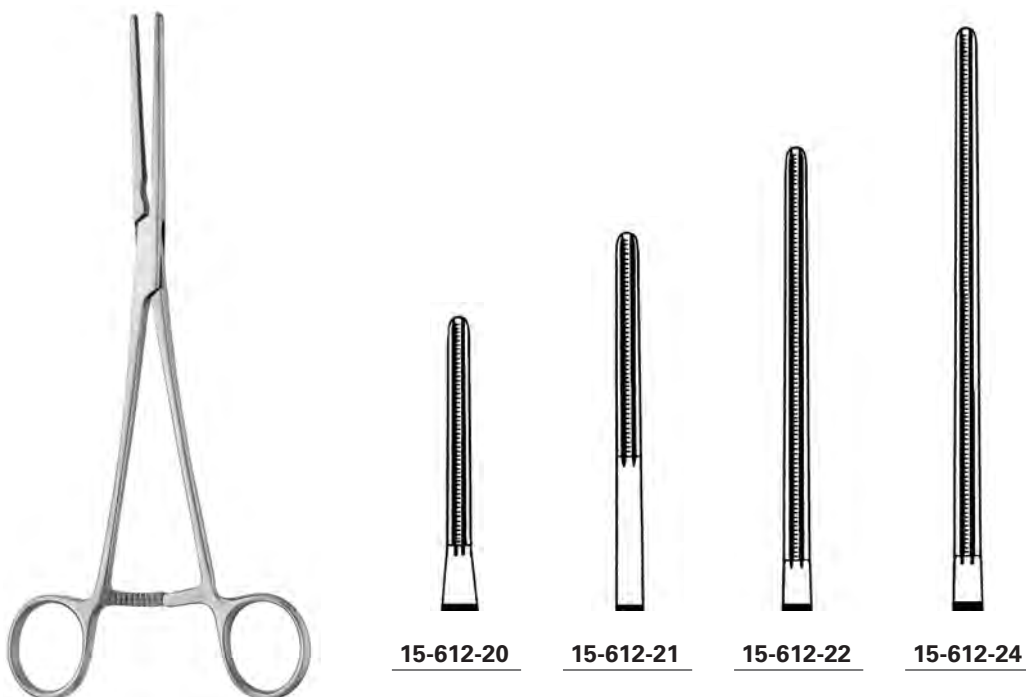
**15-611-21** 20,0 cm, 8"



**15-615-21** **15-615-22**  
 

**POTTS**

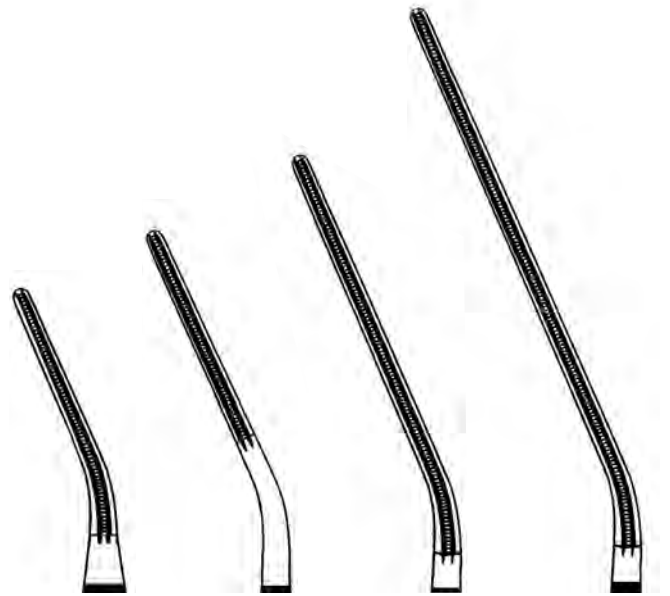
**15-615-21** 21,0 cm, 8 ¼"  
**15-615-22** 22,0 cm, 8 ¾"



**15-612-20** **15-612-21** **15-612-22** **15-612-24**  
   

**POTTS**

**15-612-20** 20,5 cm, 8"  
**15-612-21** 21,0 cm, 8 ¼"  
**15-612-22** 22,5 cm, 9"  
**15-612-24** 24,0 cm, 9 ½"



**15-613-20**

**15-613-21**

**15-613-22**

**15-613-24**



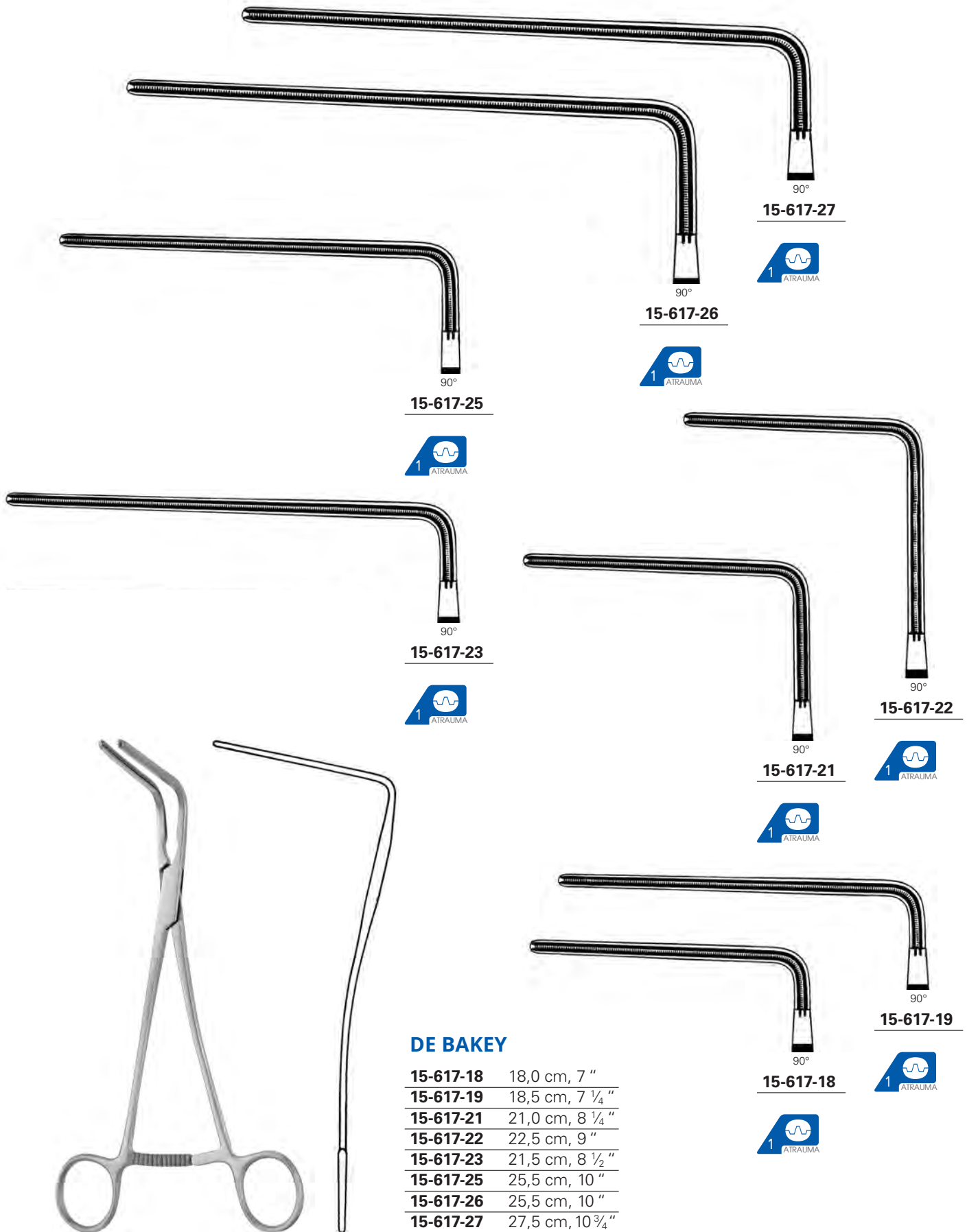
**POTTS**

**15-613-20** 20,0 cm, 8"

**15-613-21** 20,5 cm, 8"

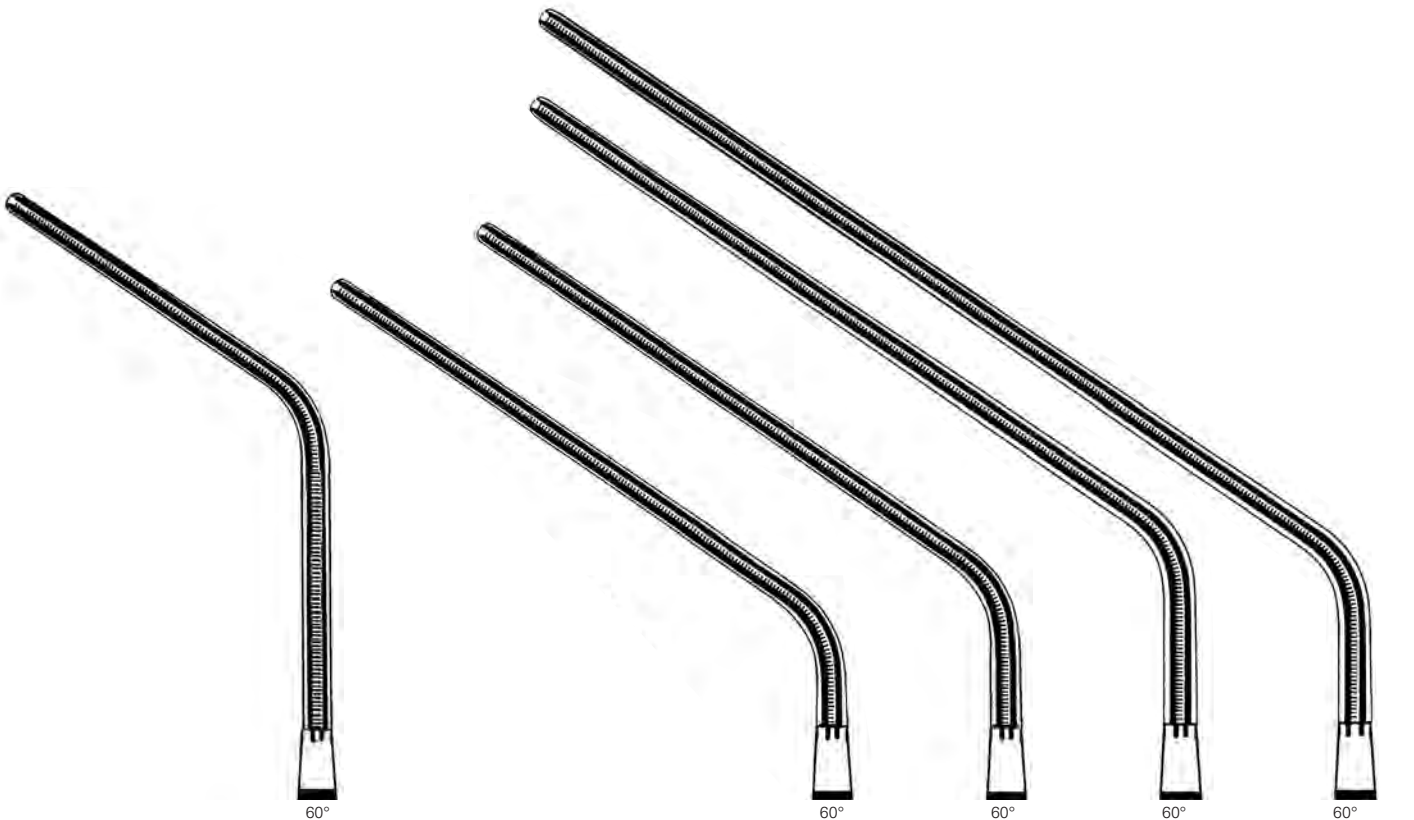
**15-613-22** 22,0 cm, 8 3/4"

**15-613-24** 24,0 cm, 9 1/2"



**DE BAKKEY**

<b>15-617-18</b>	18,0 cm, 7 "
<b>15-617-19</b>	18,5 cm, 7 ¼ "
<b>15-617-21</b>	21,0 cm, 8 ¼ "
<b>15-617-22</b>	22,5 cm, 9 "
<b>15-617-23</b>	21,5 cm, 8 ½ "
<b>15-617-25</b>	25,5 cm, 10 "
<b>15-617-26</b>	25,5 cm, 10 "
<b>15-617-27</b>	27,5 cm, 10 ¾ "



15-619-24

15-619-25

15-619-28

15-619-29

15-619-30



15-619-20

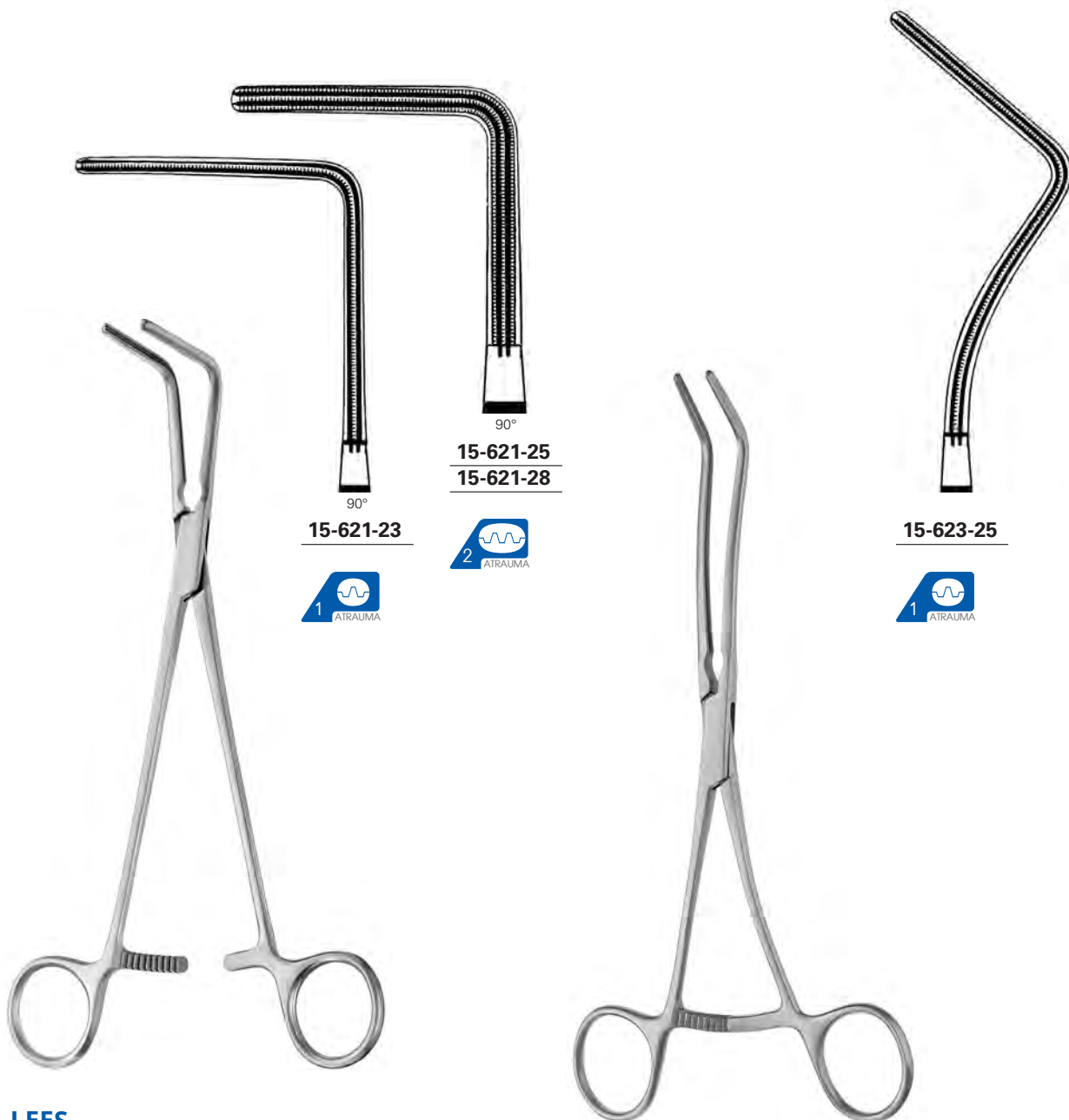
15-619-21

15-619-23



**DE BAKY**

15-619-20	21,0 cm, 8 ¼ "
15-619-21	22,0 cm, 8 ¾ "
15-619-23	23,0 cm, 9 "
15-619-24	24,0 cm, 9 ½ "
15-619-25	26,0 cm, 10 ¼ "
15-619-28	28,0 cm, 11 "
15-619-29	31,0 cm, 12 ¼ "
15-619-30	30,5 cm, 12 "



15-621-23



15-621-25  
 15-621-28



15-623-25

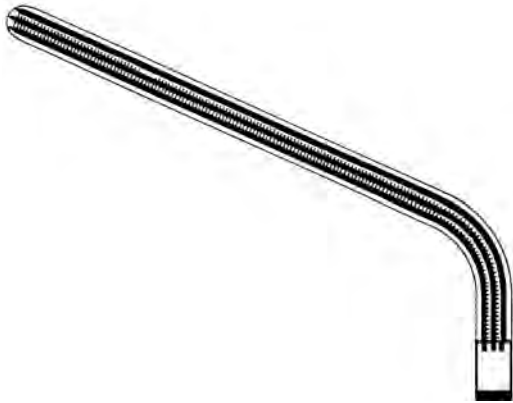


**LEES**

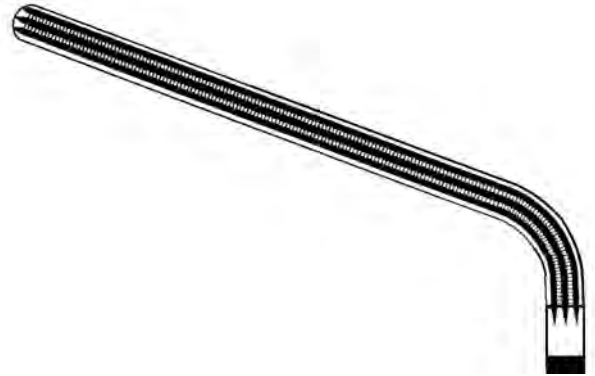
15-621-23	23,0 cm, 9"
15-621-25	25,5 cm, 10"
15-621-28	28,0 cm, 11"

**LEES**

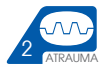
15-623-25	25,0 cm, 9 3/4"
-----------	-----------------



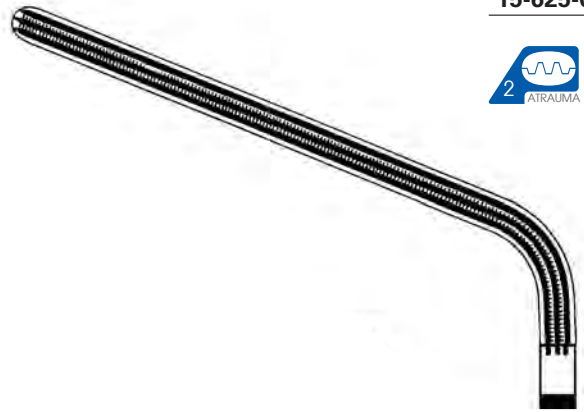
15-625-05



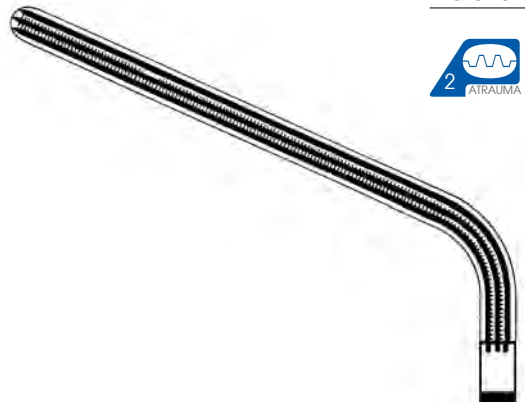
15-625-06



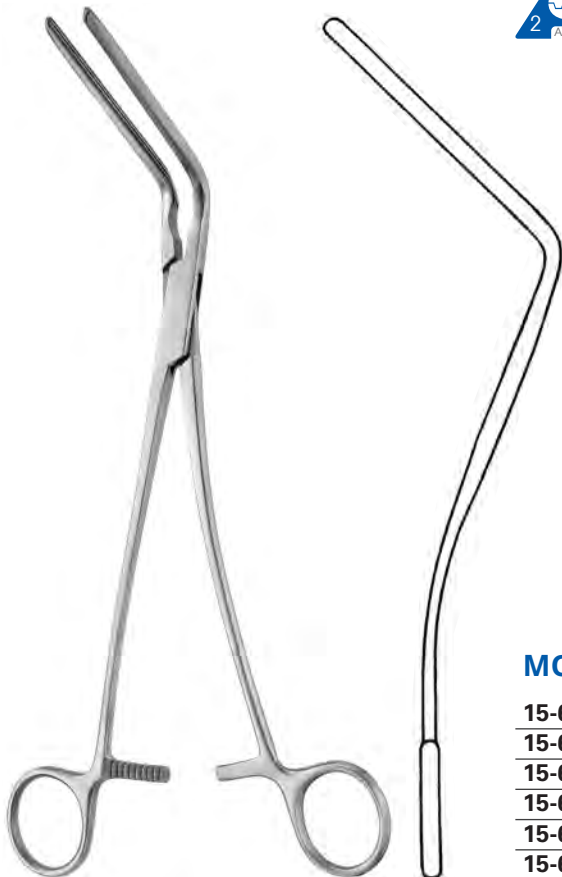
15-625-03



15-625-04



15-625-02



**MORRIS-DE BAKELY**

15-625-01	16,5 cm, 6 1/2"
15-625-02	20,0 cm, 8"
15-625-03	24,0 cm, 9 1/2"
15-625-04	26,0 cm, 10 1/4"
15-625-05	17,5 cm, 7"
15-625-06	24,0 cm, 9 1/2"



15-625-01







15-627-27



15-629-24



15-631-24



### DE BAKEY

15-627-27 27,0 cm, 10 <sup>3</sup>/<sub>4</sub>''

### DE BAKEY

15-629-24 24,0 cm, 9 <sup>1</sup>/<sub>2</sub>''

15-631-24 24,5 cm, 9 <sup>2</sup>/<sub>3</sub>''



**15-633-14**



**15-633-16**

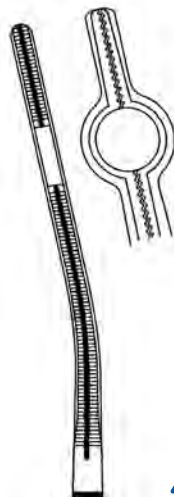


**15-633-18**



**GREGORY**

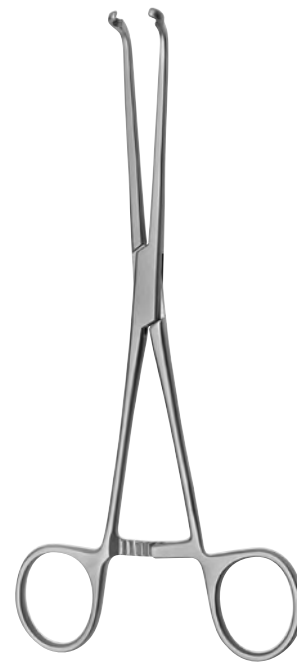
<b>15-633-14</b>	13,0 cm, 5 1/8"
<b>15-633-16</b>	16,0 cm, 6 1/4"
<b>15-633-18</b>	18,0 cm, 7"



<b>15-634-01</b>	24 Charr.
<b>15-634-02</b>	26 Charr.
<b>15-634-03</b>	28 Charr.
<b>15-634-04</b>	30 Charr.
<b>15-634-05</b>	32 Charr.
<b>15-634-07</b>	36 Charr.

**COOLEY**

<b>15-634-01 - 15-634-02</b>	16,0 cm, 6 1/4"
<b>15-634-03 - 15-634-07</b>	20,0 cm, 8"



**JAVID**

<b>15-635-16</b>	17,5 cm, 7"
------------------	-------------





**JAVID**

**15-635-19** 18,0 cm, 7 "



**HUSFELDT**

**15-636-01** 17,5 cm, 7 "



**15-636-01**

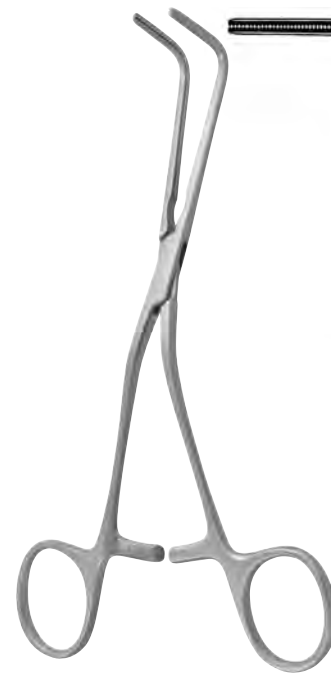


**HUSFELDT**

**15-636-02** 18,0 cm, 7 "



**15-636-02**



**HUSFELDT**

**15-636-03** 17,0 cm, 6 3/4 "



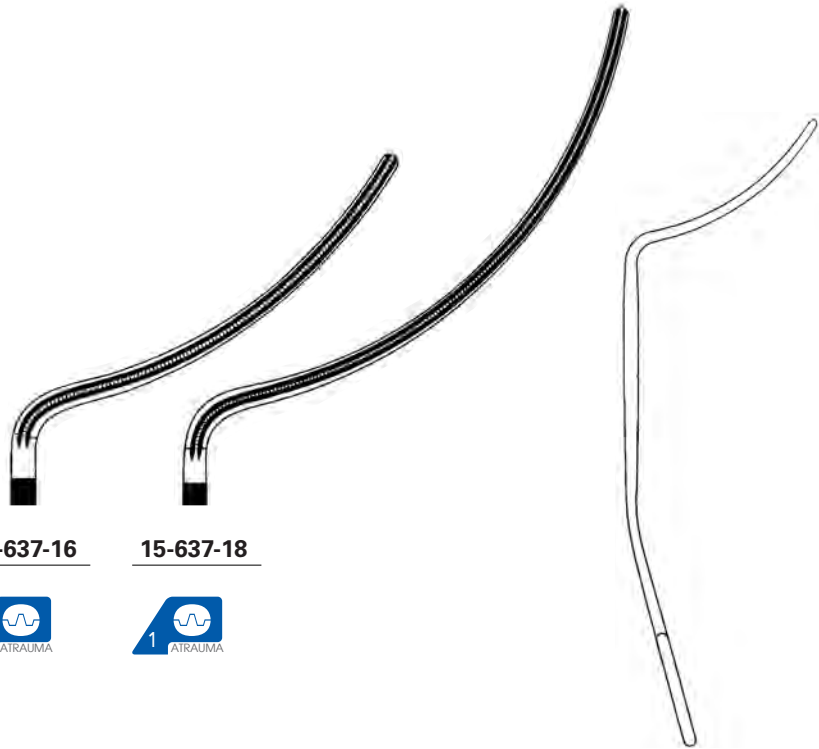
**15-636-03**





**15-637-16**

**15-637-18**



**DE BAKEY**

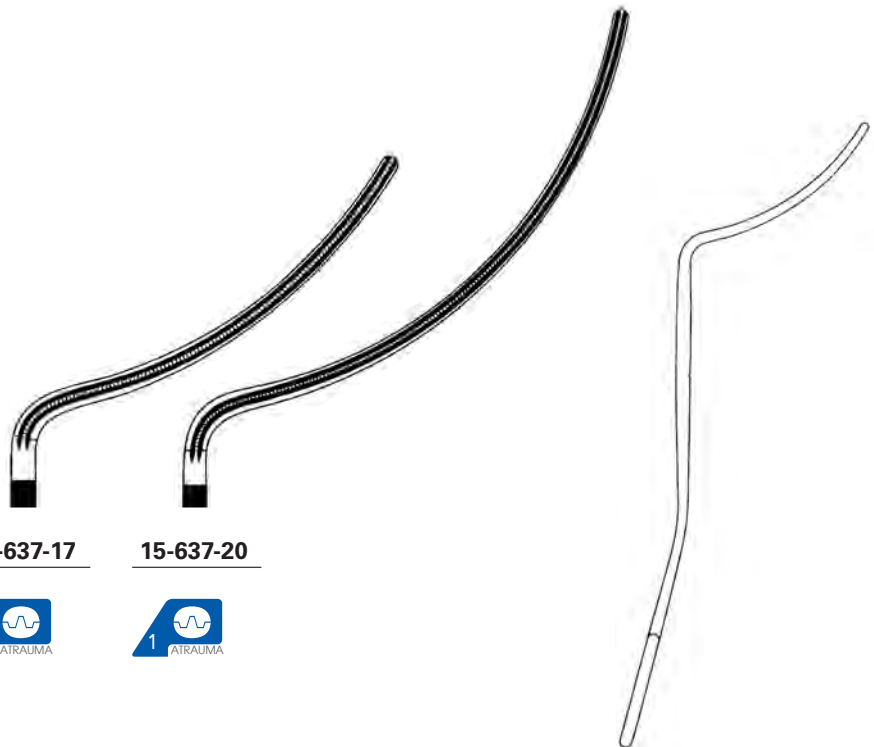
**15-637-16** 16,0 cm, 6 ¼"

**15-637-18** 18,0 cm, 7"



**15-637-17**

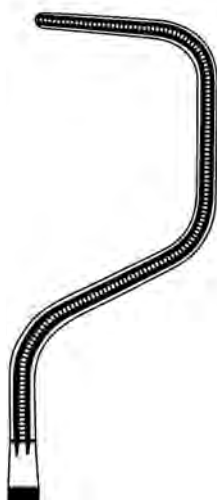
**15-637-20**



**DE BAKEY**

**15-637-17** 16,5 cm, 6 ½"

**15-637-20** 19,5 cm, 7 ¾"

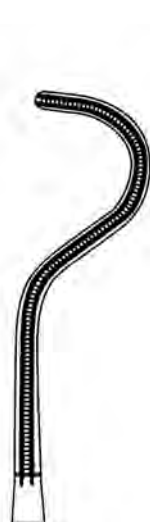


**15-639-18**



**DALE**

**15-639-18** 18,0 cm, 7"



**15-641-17**



**15-641-18**



**15-641-19**



**DALE**

**15-641-17** 17,5 cm, 7"

**15-641-18** 18,0 cm, 7"

**15-641-19** 19,5 cm, 7 3/4"



**15-643-21**  
**15-643-25**



**15-643-22**



**LAMBERT-KAY**

<b>15-643-21</b>	21,5 cm, 8 ½"
<b>15-643-22</b>	22,0 cm, 8 ¾"
<b>15-643-25</b>	25,5 cm, 10"



**15-645-17**



**15-645-20**



**DE BAKEY**

<b>15-645-17</b>	16,5 cm, 6 ½"
------------------	---------------

**COOLEY**

<b>15-645-20</b>	20,0 cm, 8"
------------------	-------------

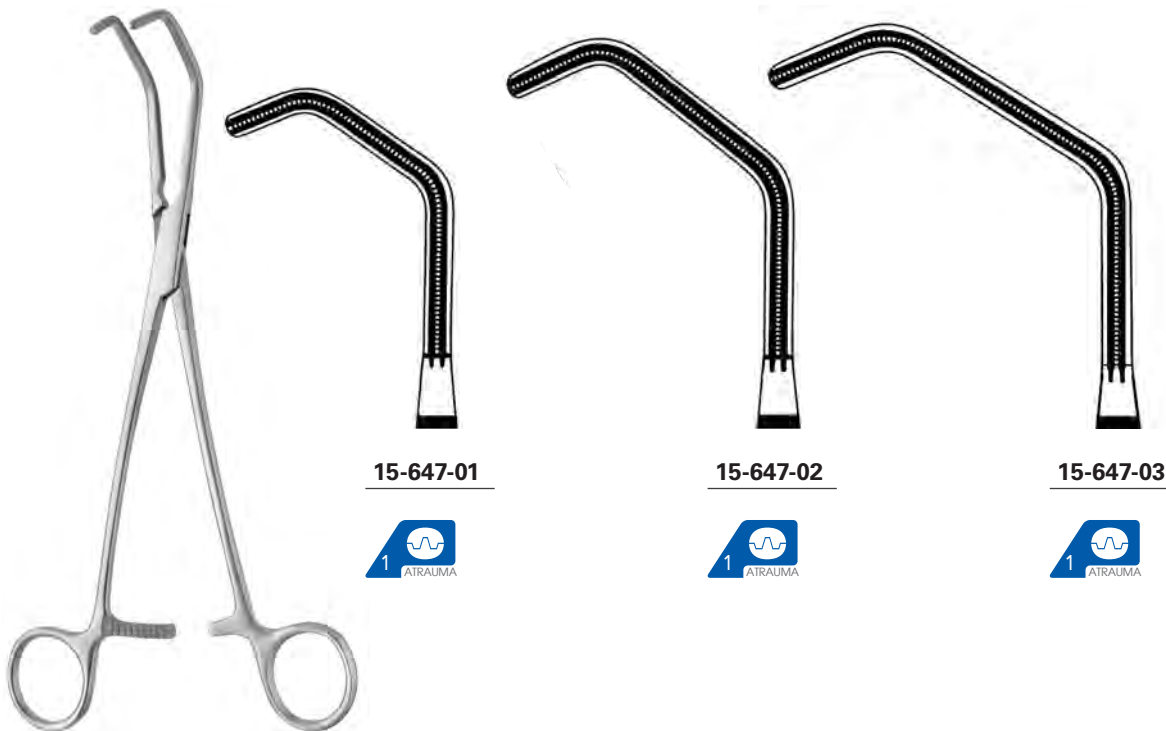


**HENLEY**

**15-646-19** 19,5 cm, 7 3/4"

**OCHSNER**

**15-649-23** 23,5 cm, 9 1/4"



**DE BAKEY-SATINSKY**

**15-647-01** 23,5 cm, 9 1/4"

**15-647-02** 24,0 cm, 9 1/2"

**15-647-03** 24,5 cm, 9 2/3"



15-647-26



1 ATRAUMA

1

1

1

1

1

1

1

1

1

1

1

1

1

1

1

1

1

1

1

1

1

1

1

1

1

1

1

1

1

1

1

1

1

1

1

1

1

1

1

1

1

1

1

1

1

1

1

1

1

1

1

1

1

1

1

1

1

1

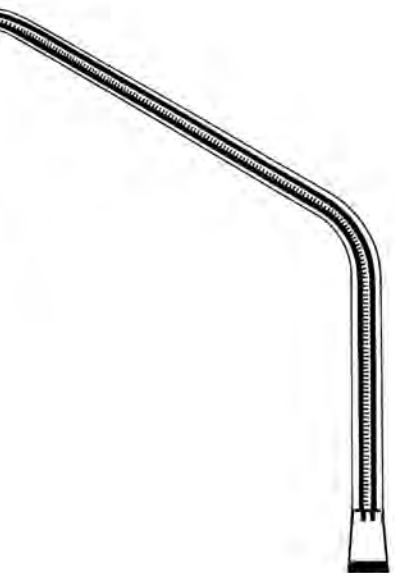
1

1

1

1

1



15-647-27



1 ATRAUMA

1

1

1

1

1

1

1

1

1

1

1

1

1

1

1

1

1

1

1

1

1

1

1

1

1

1

1

1

1

1

1

1

1

1

1

1

1

1

1

1

1

1

1

1

1

1

1

1

1

1

1

1

1

1

1

1

1

1

1

1

1

1

1



15-647-25



1 ATRAUMA

1

1

1

1

1

1

1

1

1

1

1

1

1

1

1

1

1

1

1

1

1

1

1

1

1

1

1

1

1

1

1

1

1

1

1



15-647-24



1 ATRAUMA

1

1

1

1

1

1

1

1

1

1

1

1

1

1

1

1

1

1

1

1

1

1

1

1

1

1

1

1

1

1

1

1

1

1

1



**SATINSKY**

15-647-20	22,0 cm, 8 3/4"
15-647-24	26,0 cm, 10 1/4"
15-647-25	26,5 cm, 10 1/2"
15-647-26	27,5 cm, 10 3/4"
15-647-27	28,5 cm, 11 1/4"



15-647-20



1 ATRAUMA

1

1

1

1

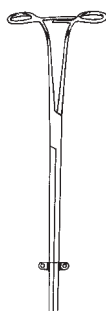
1

1

1

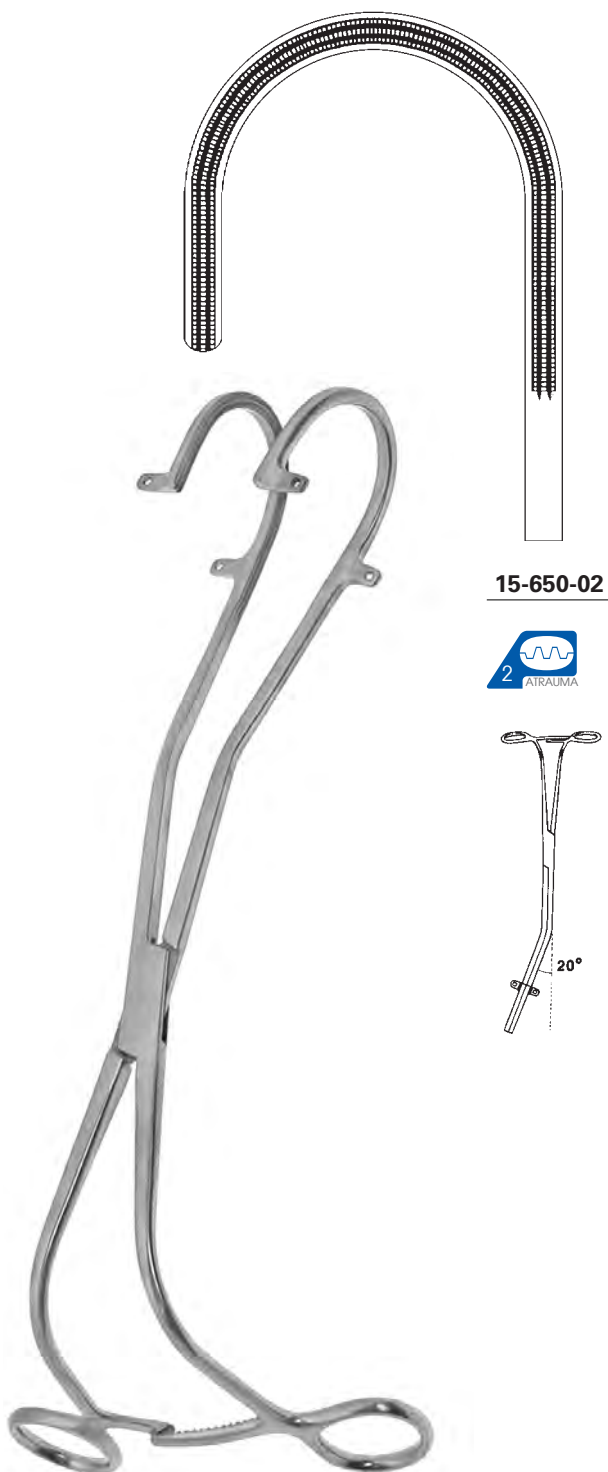


15-650-01

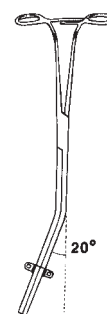


**T - ATRAUMA**

15-650-01 29,0 cm, 11 1/2"



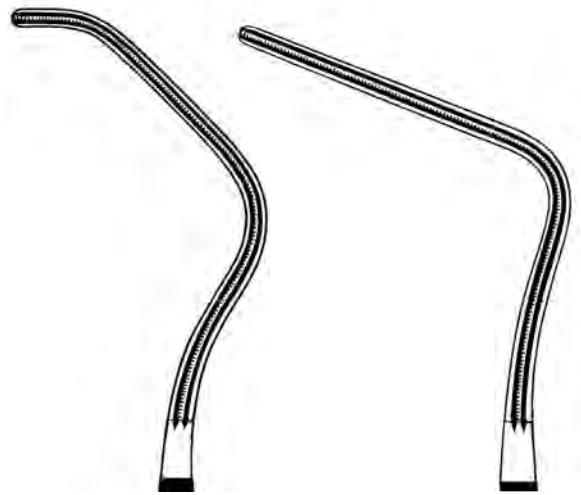
15-650-02



**T - ATRAUMA**

15-650-02 29,0 cm, 11 1/2"





**15-653-03**

**15-653-04**



**15-651-21**



**DIETRICH**

**15-651-21** 22,0 cm, 8 3/4"



**15-653-01**

**15-653-02**



**HARKEN**

- 15-653-01** 24,5 cm, 9 2/3"
- 15-653-02** 24,5 cm, 9 2/3"
- 15-653-03** 23,0 cm, 9"
- 15-653-04** 23,5 cm, 9 1/4"





15-654-01

15-654-02



**COOLEY**

15-654-01 - 15-654-02 14,5 cm, 5 3/4"



15-654-03



**COOLEY**

15-654-03 14,0 cm, 5 1/2"



15-654-04



**COOLEY**

15-654-04 14,0 cm, 5 1/2"



15-654-05

15-654-06



**COOLEY**

15-654-05 - 15-654-06 14,5 cm, 5 3/4"



**COOLEY**

**15-655-01** 12,5 cm, 5"  
**15-655-02** 11,5 cm, 4 1/2"



**15-655-01**

**15-655-02**



**COOLEY**

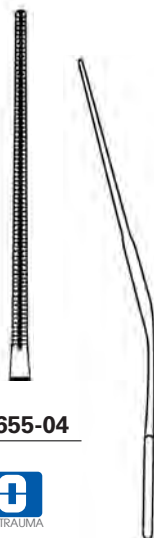
**15-655-03** 10,0 cm, 4"

**15-655-03**



**COOLEY**

**15-655-04** 12,5 cm, 5"



**15-655-04**



**COOLEY**

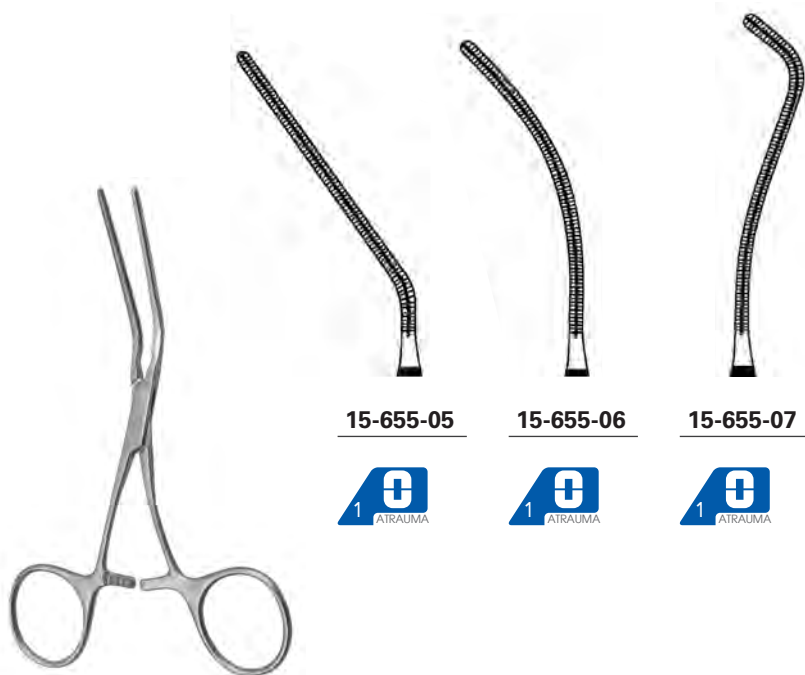
**15-655-08** 12,0 cm, 4 3/4"  
**15-655-09** 11,5 cm, 4 1/2"



**15-655-08**

**15-655-09**





15-655-05

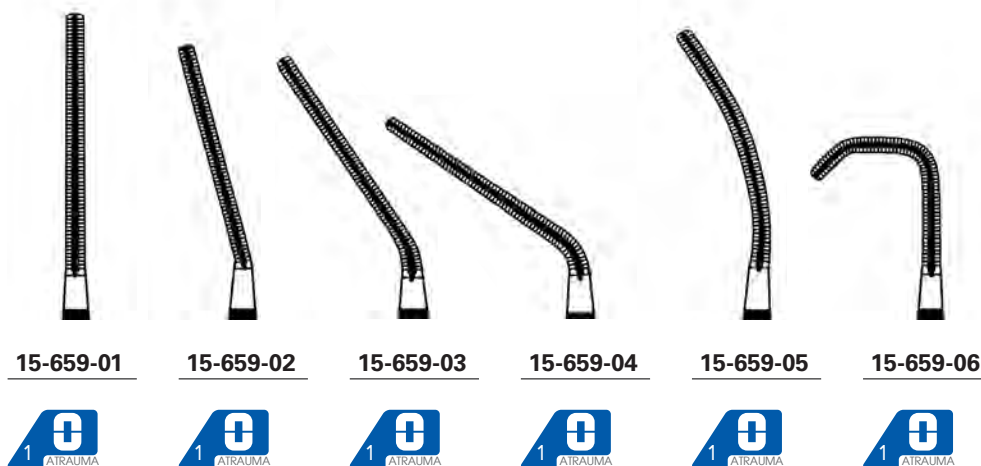
15-655-06

15-655-07



**COOLEY**

15-655-05	12,0 cm, 4 3/4"
15-655-06	12,5 cm, 5"
15-655-07	12,5 cm, 5"



15-659-01

15-659-02

15-659-03

15-659-04

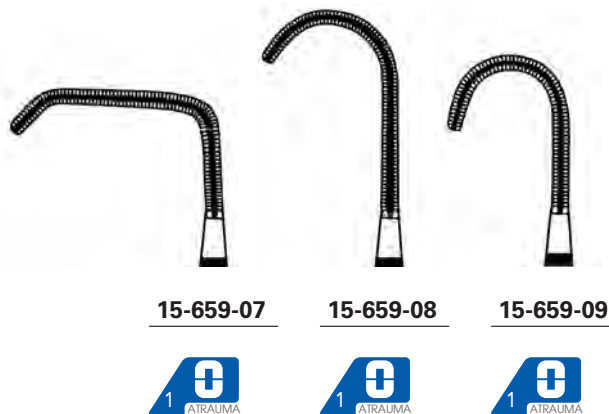
15-659-05

15-659-06



**COOLEY**

15-659-01	13,5 cm, 5 1/4"
15-659-02	13,5 cm, 5 1/4"
15-659-03	14,0 cm, 5 1/2"
15-659-04	13,5 cm, 5 1/4"
15-659-05	13,5 cm, 5 1/4"
15-659-06	12,5 cm, 5"
15-659-07	13,0 cm, 5 1/8"
15-659-08	13,5 cm, 5 1/4"
15-659-09	13,0 cm, 5 1/8"

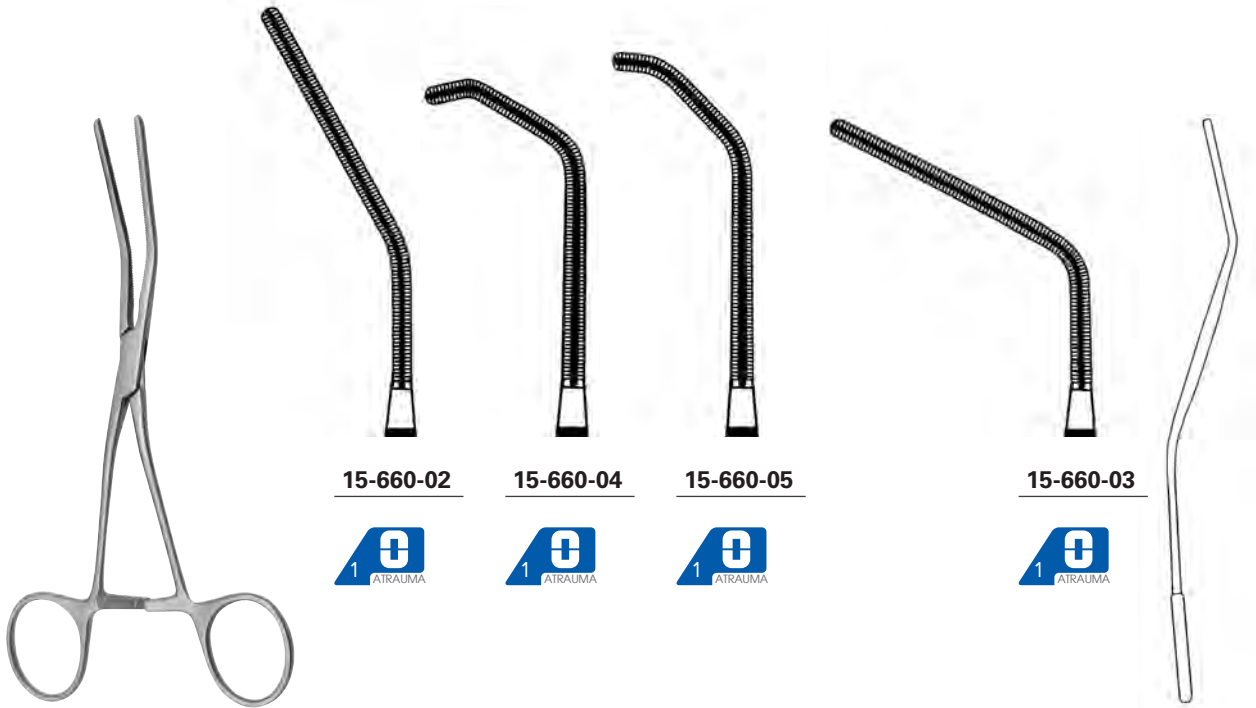


15-659-07

15-659-08

15-659-09





15-660-02

15-660-04

15-660-05

15-660-03



**COOLEY**

15-660-02	16,0 cm, 6 1/4"
15-660-03	15,5 cm, 6 1/8"
15-660-04	15,5 cm, 6 1/8"
15-660-05	16,0 cm, 6 1/4"



15-660-01

15-661-01



**COOLEY**

15-660-01	16,5 cm, 6 1/2"
-----------	-----------------

**COOLEY**

15-661-01	17,0 cm, 6 3/4"
-----------	-----------------



15-661-02



**COOLEY**

15-661-02 17,0 cm, 6 3/4"



15-661-03



**COOLEY**

15-661-03 17,5 cm, 7"

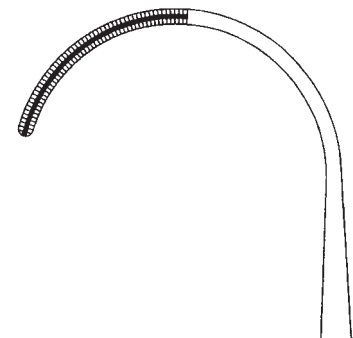


15-661-04

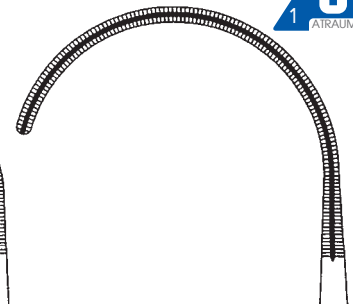


**COOLEY**

15-661-04 16,5 cm, 6 1/2"  
 15-661-05 17,0 cm, 6 3/4"  
 15-661-06 15,0 cm, 6"  
 15-661-07 15,5 cm, 6 1/8"  
 15-661-08 17,0 cm, 6 3/4"



15-661-05



15-661-06

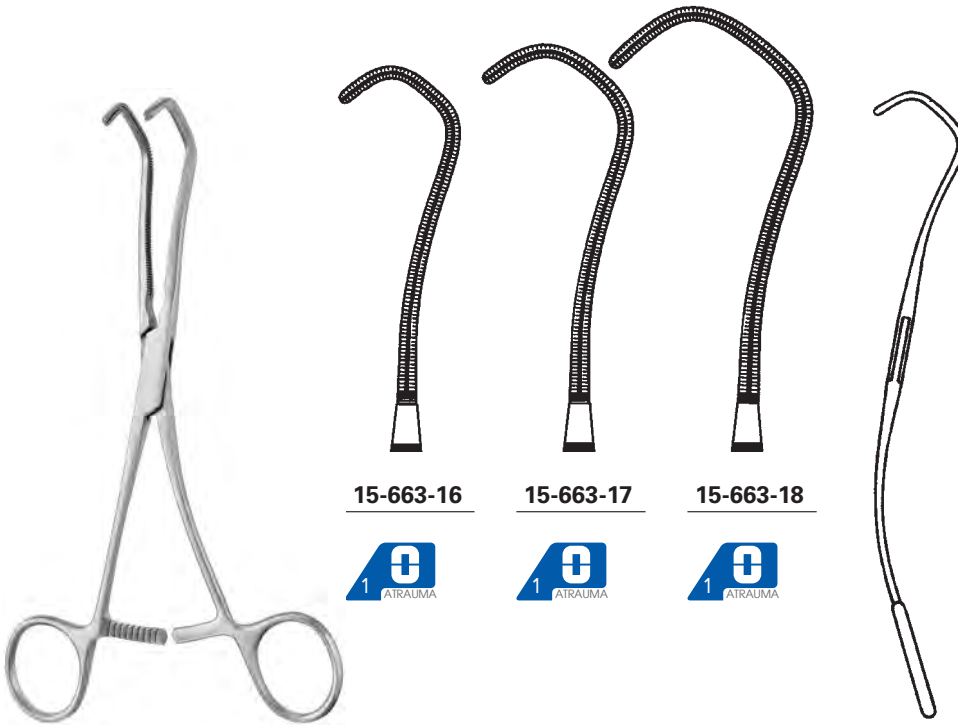


15-661-08



15-661-07





15-663-16

15-663-17

15-663-18



**COOLEY**

15-663-16	16,5 cm, 6 1/2"
15-663-17	17,0 cm, 6 3/4"
15-663-18	17,5 cm, 7"



**COOLEY-LEITZ**

16-663-20	20,5 cm, 8"
-----------	-------------

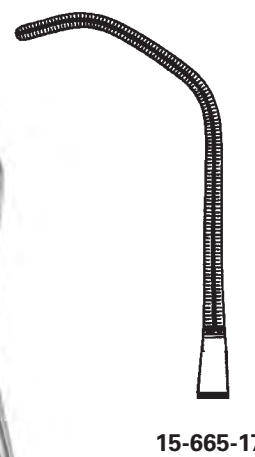


15-663-20



**COOLEY-BECK**

15-665-17	17,0 cm, 6 3/4"
-----------	-----------------



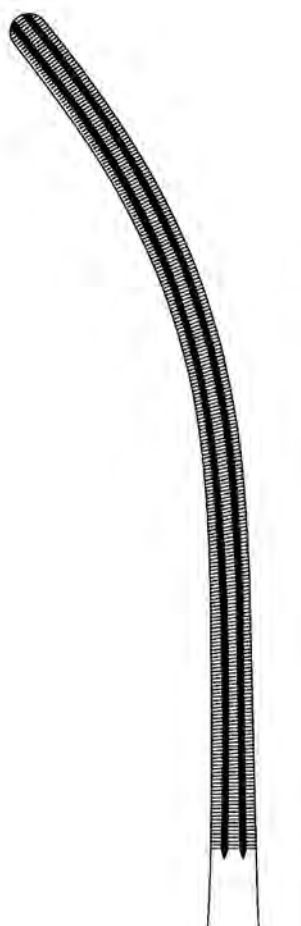
15-665-17





**COOLEY**

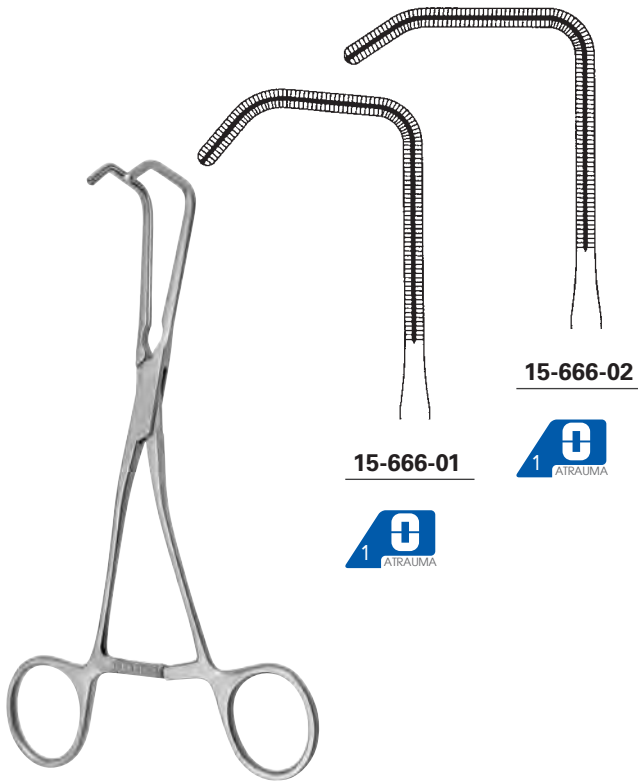
**15-664-32** 32,0 cm, 12 1/2"



**15-664-32**







15-666-01

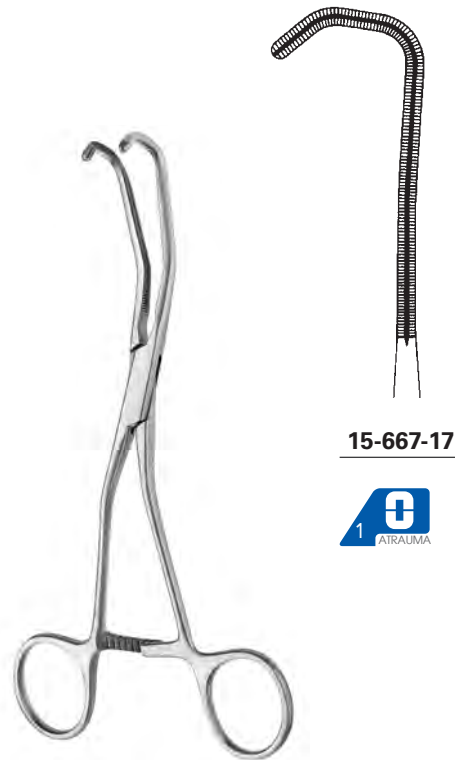


15-666-02



**COOLEY**

15-666-01 - 15-666-02 16,5 cm, 6 1/2"



15-667-17



**COOLEY**

15-667-17 17,0 cm, 6 3/4"



15-667-18



**COOLEY**

15-667-18 17,5 cm, 7"



15-669-16



**COOLEY**

15-669-16 16,0 cm, 6 1/4"





15-669-17

15-669-18



**COOLEY**

15-669-17 17,5 cm, 7 "

15-669-18 18,0 cm, 7 "

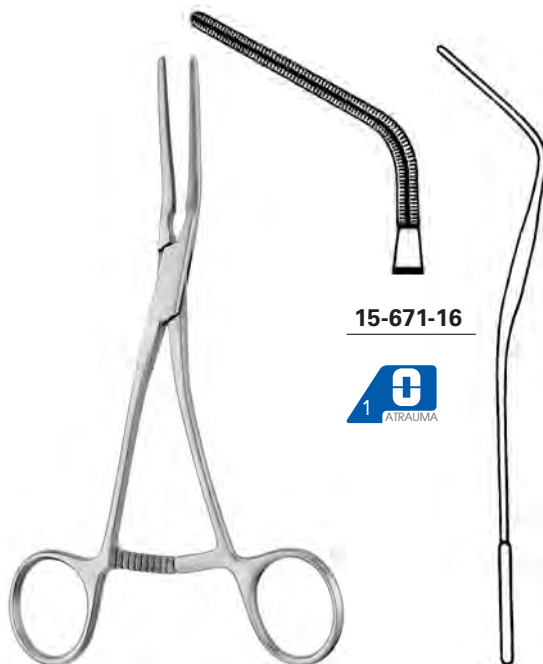


15-671-15



**COOLEY**

15-671-15 15,0 cm, 6 "

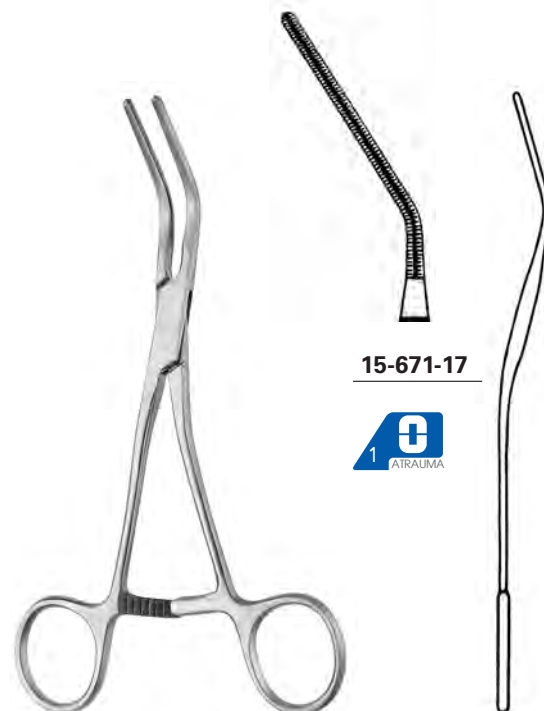


15-671-16



**COOLEY**

15-671-16 16,0 cm, 6 ¼ "



15-671-17



**COOLEY**

15-671-17 16,5 cm, 6 ½ "



15-672-16



15-672-17



**COOLEY**

15-672-16	16,0 cm, 6 1/4"
15-672-17	17,0 cm, 6 3/4"



15-673-21



15-673-27



**COOLEY**

15-673-21	22,0 cm, 8 3/4"
15-673-27	27,0 cm, 10 3/4"



15-675-18



15-675-19



**COOLEY**

15-675-18	18,5 cm, 7 1/4"
15-675-19	19,5 cm, 7 3/4"

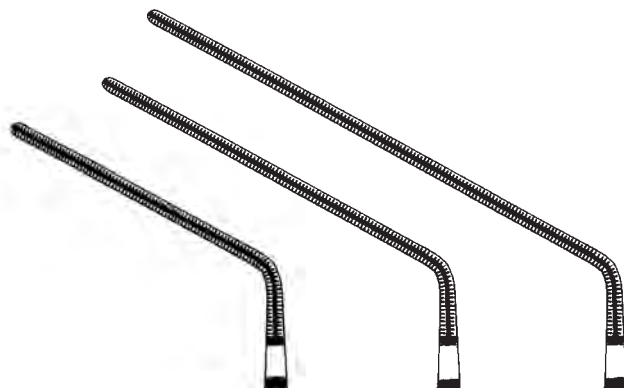


15-675-20  
15-675-26



**COOLEY**

15-675-20	20,0 cm, 8"
15-675-26	26,0 cm, 10 1/4"



15-678-01

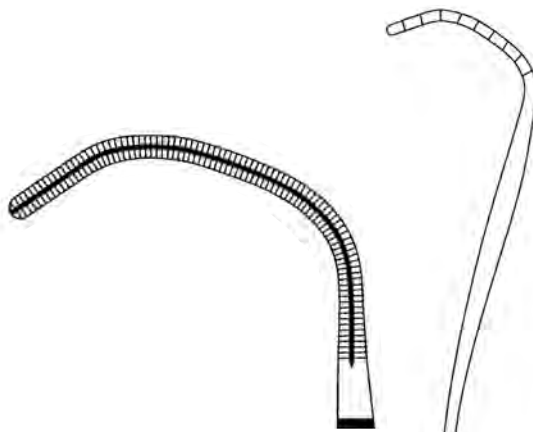
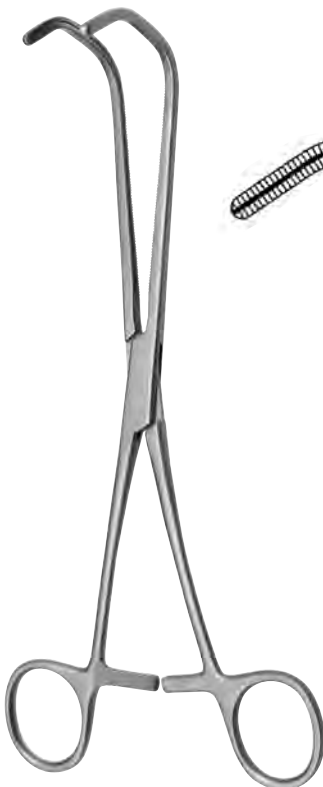
15-678-02

15-678-03



**COOLEY**

15-678-01	16,5 cm, 6 1/2"
15-678-02	17,0 cm, 6 3/4"
15-678-03	18,5 cm, 7 1/4"



15-679-22



**COOLEY**

15-679-22	22,0 cm, 8 3/4"
-----------	-----------------



15-679-28



**COOLEY**

15-679-28	28,5 cm, 11 1/4"
-----------	------------------



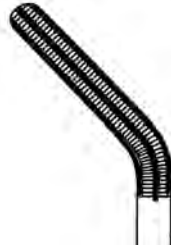
**15-680-00**



**15-680-15**



**15-680-30**



**15-680-45**



**15-680-90**



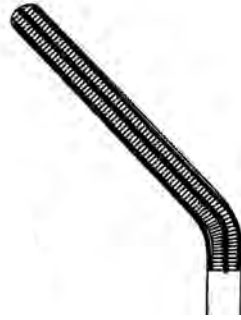
**15-682-00**



**15-682-15**



**15-682-30**



**15-682-45**



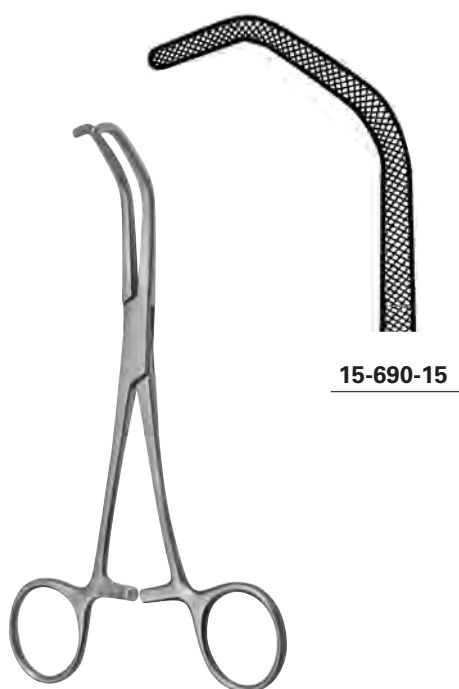
**15-682-90**



**DARDIK**

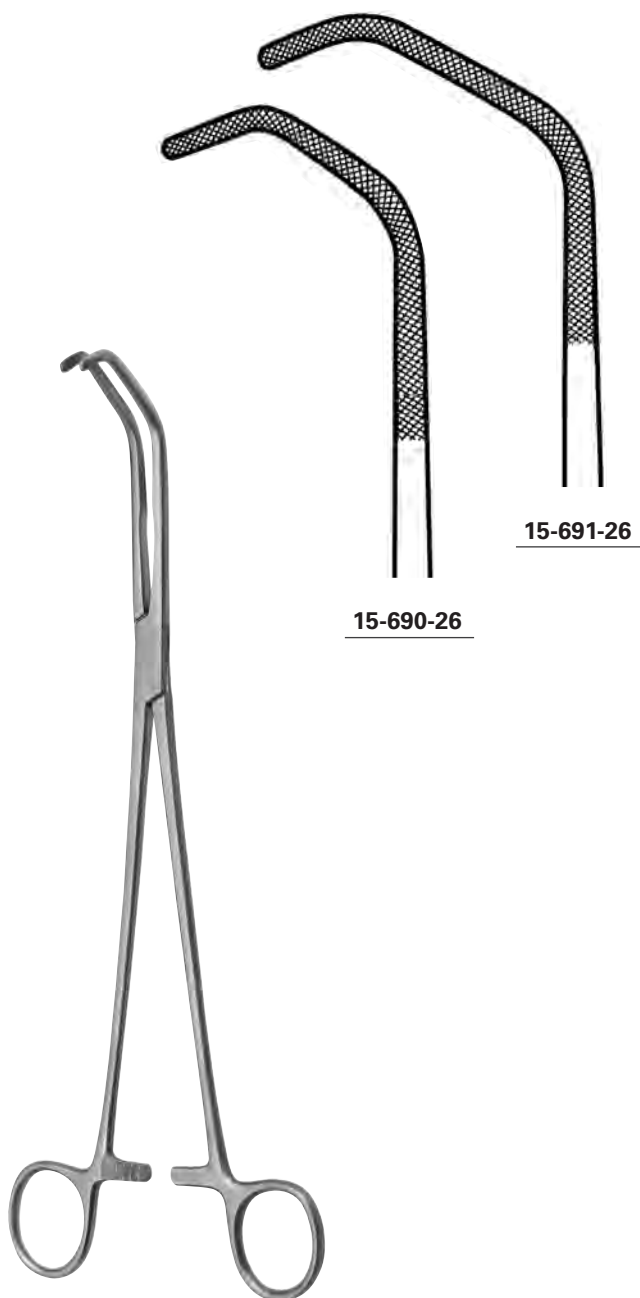
**15-680-00 - 15-680-90** 15,0 cm, 6''

**15-682-00 - 15-682-90** 17,0 cm, 6 3/4''



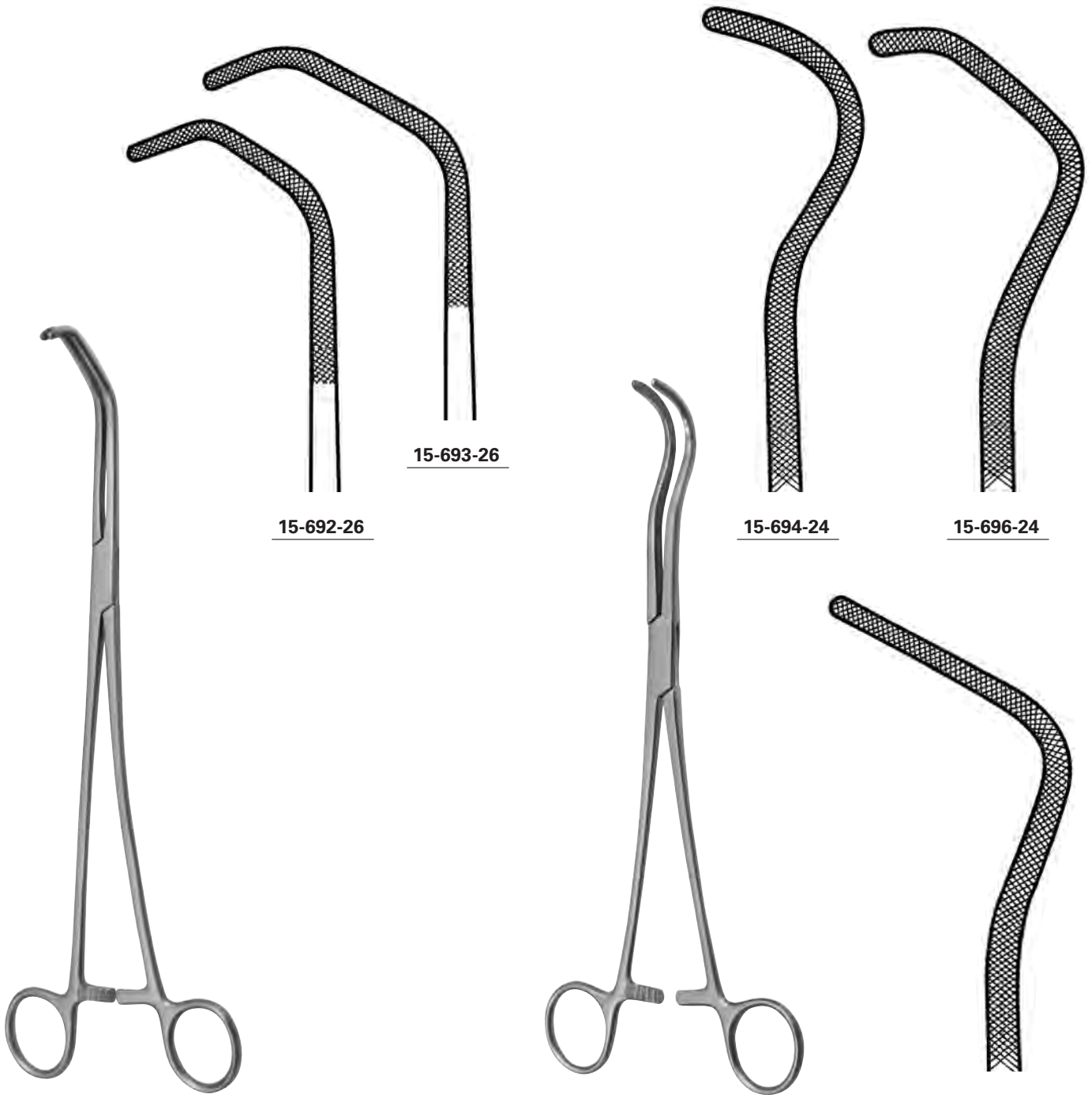
**BABY-SATINSKY**

15-690-15 15,0 cm, 6"



**SATINSKY**

15-690-26 - 15-691-26 26,5 cm, 10 1/2"



15-692-26  
15-693-26

15-694-24  
15-696-24

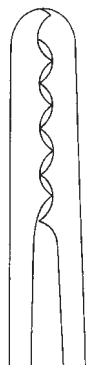
15-695-24

**SATINSKY-S**

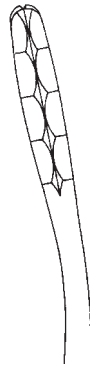
15-692-26 - 15-693-26 26,5 cm, 10 ½"

**HARKEN**

15-694-24 - 15-696-24 24,0 cm, 9 ½"



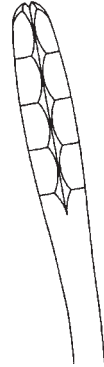
**15-700-22**



**15-701-22**



**15-700-27**



**15-701-27**

### ULRICH

**15-700-22 - 15-701-22** 22,5 cm, 9"

**15-700-27 - 15-701-27** 26,5 cm, 10½"



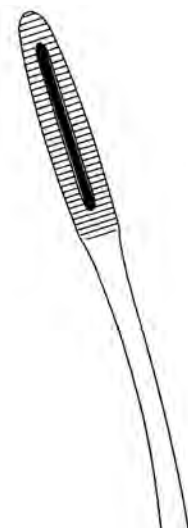
### GROSS-MAIER

**15-702-20** 20,0 cm, 8"

**15-702-22** 22,0 cm, 8¾"

**15-702-25** 25,0 cm, 9¾"

**15-702-27** 27,0 cm, 10¾"



### GROSS-MAIER

**15-703-20** 20,0 cm, 8"

**15-703-22** 22,0 cm, 8¾"

**15-703-25** 25,0 cm, 9¾"

**15-703-27** 27,0 cm, 10¾"





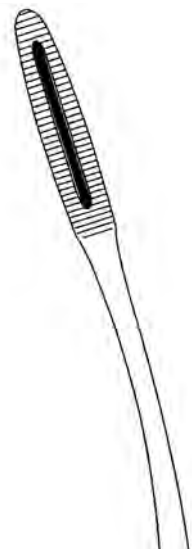
**GROSS-MAIER**

<b>15-704-20</b>	20,0 cm, 8 "
<b>15-704-22</b>	22,0 cm, 8 3/4 "
<b>15-704-25</b>	25,0 cm, 9 3/4 "
<b>15-704-27</b>	27,0 cm, 10 3/4 "



**GROSS-MAIER**

<b>15-705-20</b>	20,0 cm, 8 "
<b>15-705-22</b>	22,0 cm, 8 3/4 "
<b>15-705-25</b>	25,0 cm, 9 3/4 "
<b>15-705-27</b>	27,0 cm, 10 3/4 "



**GROSS**

<b>15-706-14</b>	14,5 cm, 5 3/4 "
<b>15-706-16</b>	16,0 cm, 6 1/4 "
<b>15-706-18</b>	18,0 cm, 7 "
<b>15-706-20</b>	20,0 cm, 8 "
<b>15-706-25</b>	25,0 cm, 9 3/4 "



**GROSS**

<b>15-707-14</b>	14,5 cm, 5 3/4 "
<b>15-707-18</b>	18,0 cm, 7 "
<b>15-707-20</b>	20,0 cm, 8 "
<b>15-707-25</b>	25,0 cm, 9 3/4 "







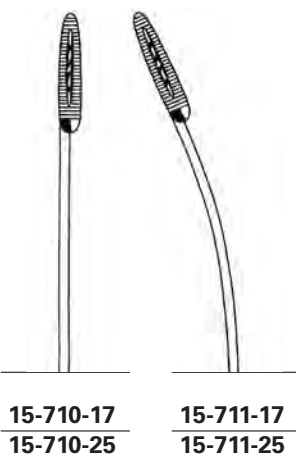
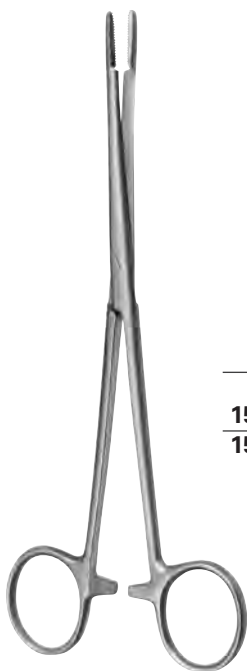
**GROSS**

<b>15-708-14</b>	14,5 cm, 5 3/4"
<b>15-708-18</b>	18,0 cm, 7"
<b>15-708-20</b>	20,0 cm, 8"
<b>15-708-25</b>	25,0 cm, 9 3/4"



**GROSS**

<b>15-709-14</b>	14,5 cm, 5 3/4"
<b>15-709-18</b>	18,0 cm, 7"
<b>15-709-20</b>	20,0 cm, 8"
<b>15-709-25</b>	25,0 cm, 9 3/4"

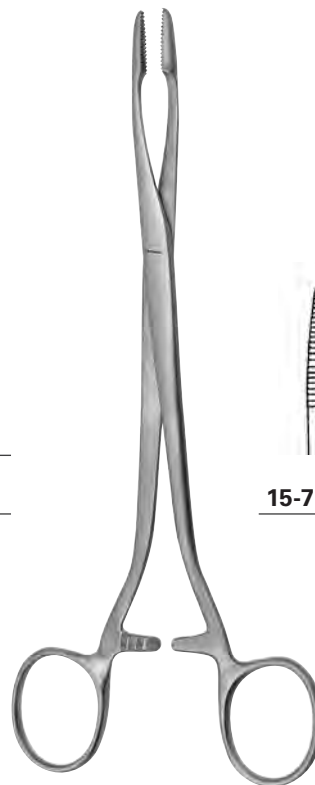


**15-710-17**  
**15-710-25**

**15-711-17**  
**15-711-25**

**MARTIN**

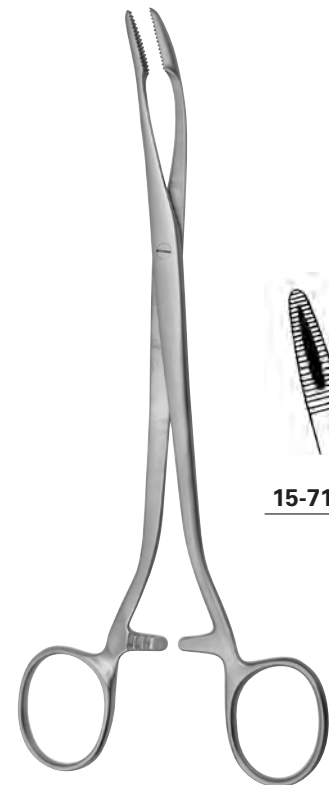
<b>15-710-17 - 15-711-17</b>	17,0 cm, 6 3/4"
<b>15-710-25 - 15-711-25</b>	25,0 cm, 9 3/4"



**15-712-21**

**DUPLAY**

<b>15-712-21</b>	21,0 cm, 8 1/4"
------------------	-----------------



**15-713-21**

**DUPLAY**

<b>15-713-21</b>	21,0 cm, 8 1/4"
------------------	-----------------



**15-713-19**

**DUPLAY-S**

**15-713-19** 19,0 cm, 7 1/2"



**15-713-22**

**PITHA**

**15-713-22** 22,0 cm, 8 3/4"



**15-714-13**

**15-714-16**

**15-714-18**

Sinusklemmen  
Sinus forceps  
Pinzas para vendajes  
Pinze per seni

**LISTER**

**15-714-13** 13,0 cm, 5"

**15-714-16** 16,0 cm, 6 1/4"

**15-714-18** 18,0 cm, 7"



**15-715-13**

**BRYANT**

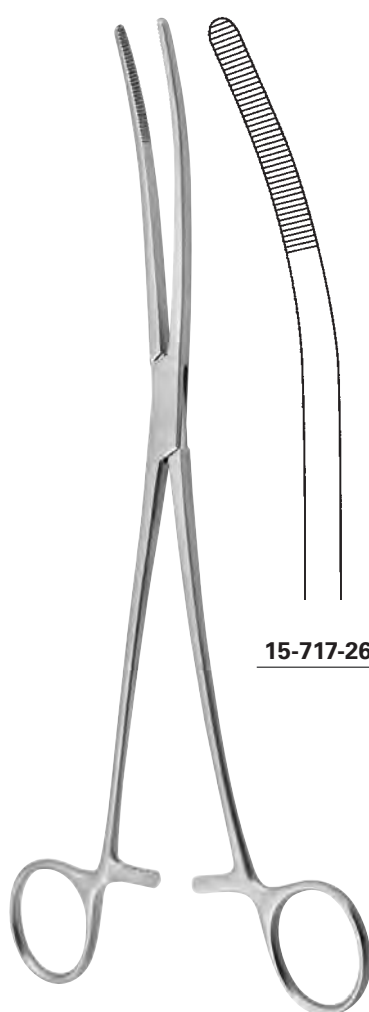
**15-715-13** 13,0 cm, 5"



**15-716-26**

**BOZEMANN**

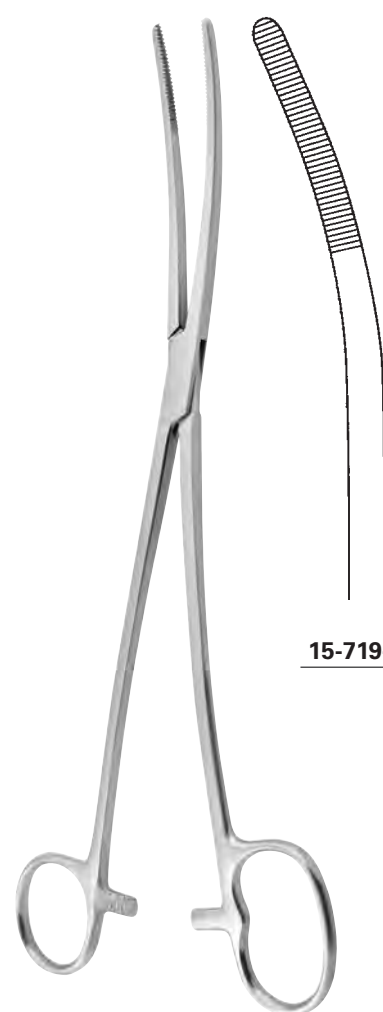
**15-716-26** 26,0 cm, 10 ¼"



**15-717-26**

**BOZEMANN-S**

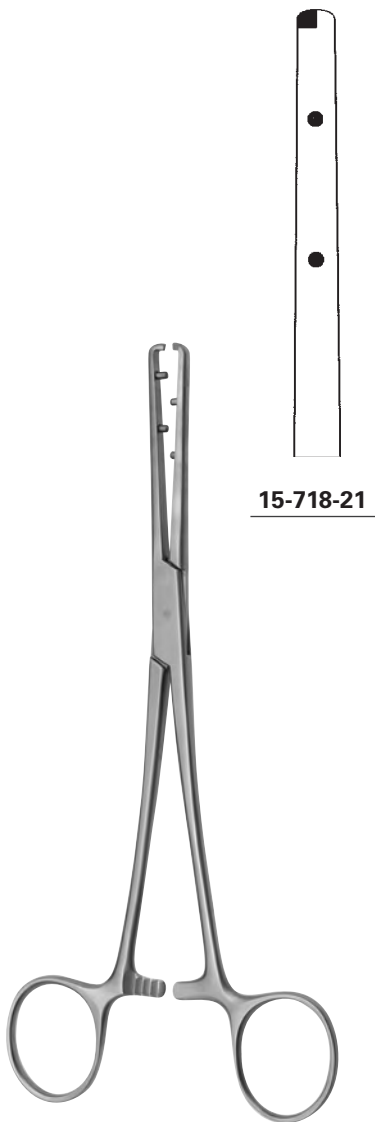
**15-717-26** 26,0 cm, 10 ¼"



**15-719-26**

**BOZEMANN-DOUGLAS**

**15-719-26** 26,0 cm, 10 ¼"



**15-718-21**

**EMMET**

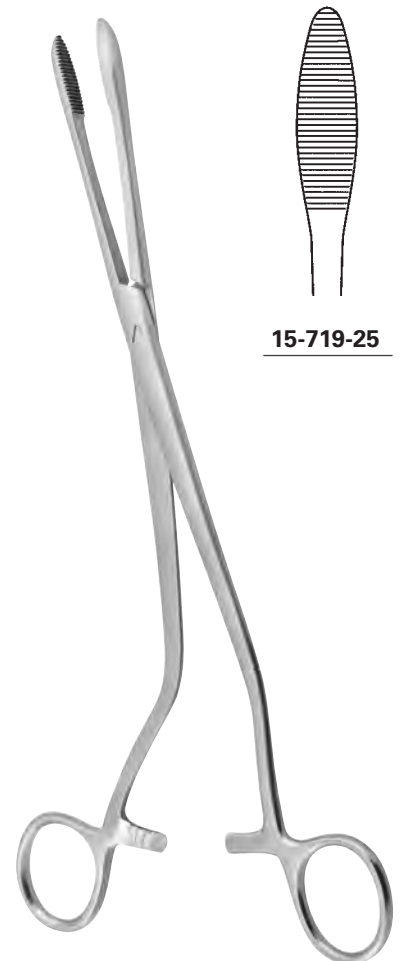
**15-718-21** 21,0 cm, 8 ¼"



**15-718-25**

**COLLIN**

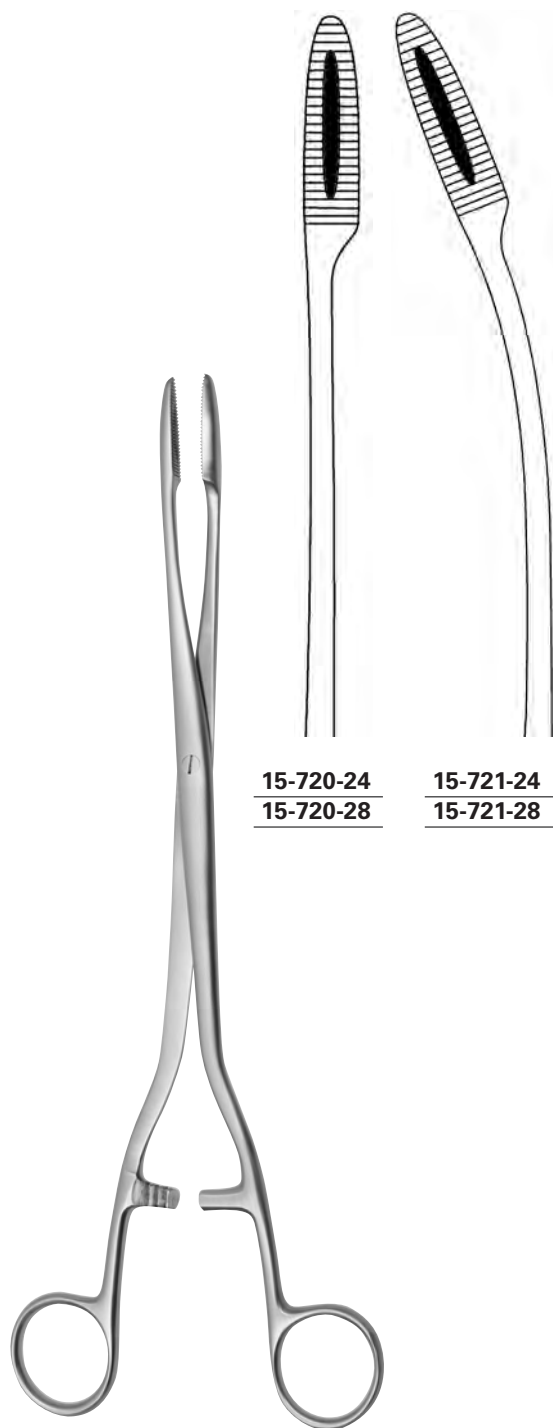
**15-718-25** 25,0 cm, 9 ¾"



**15-719-25**

**CHERON**

**15-719-25** 25,0 cm, 9 ¾"

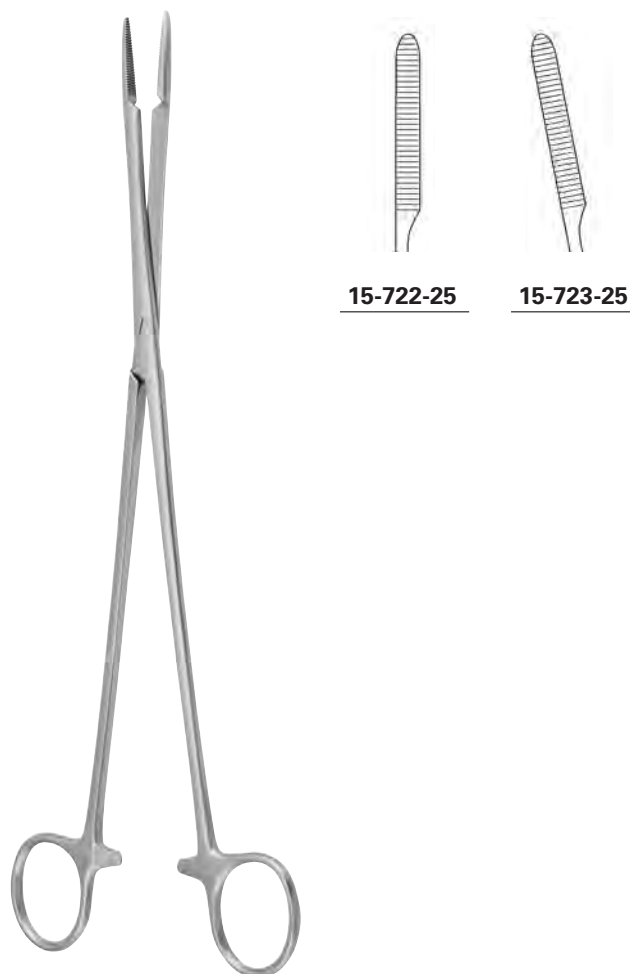


15-720-24  
15-720-28

15-721-24  
15-721-28

### SIMS-MAIER

15-720-24 - 15-721-24 24,0 cm, 9 1/2 "  
15-720-28 - 15-721-28 28,0 cm, 11 "

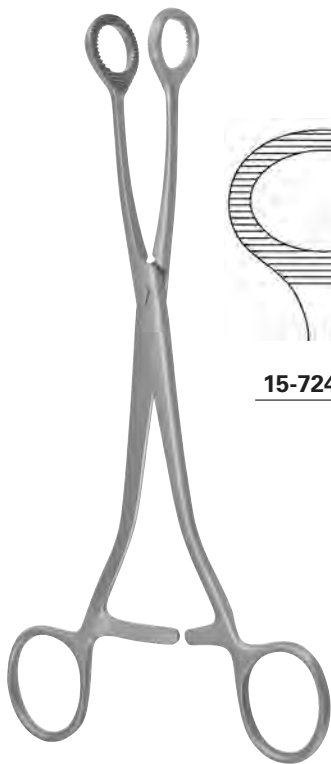


15-722-25

15-723-25

### PELKMANN

15-722-25 - 15-723-25 25,0 cm, 9 3/4 "



**15-724-18**

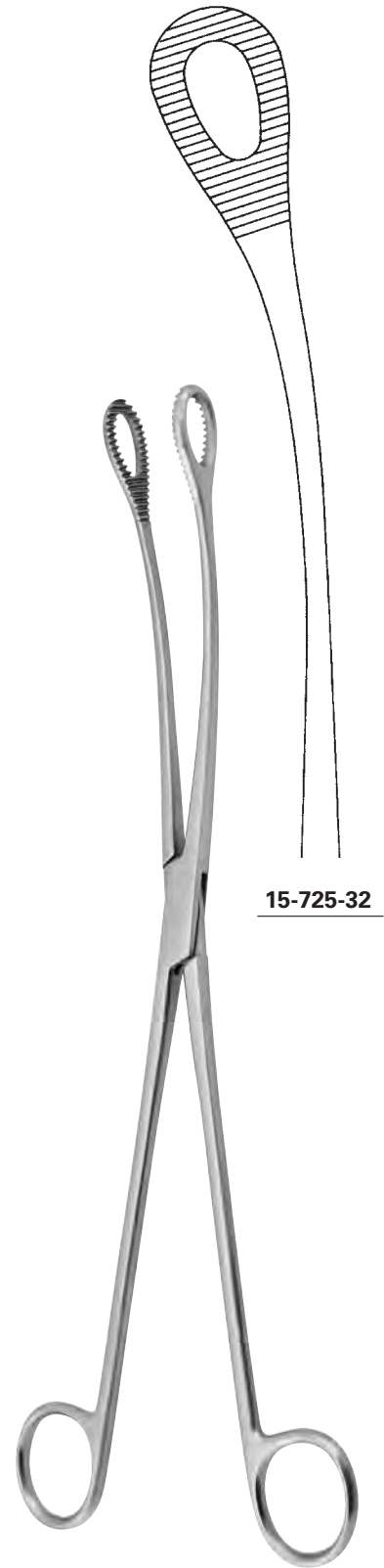
**DOYEN**

**15-724-18** 20,0 cm, 8"



**BUMM**

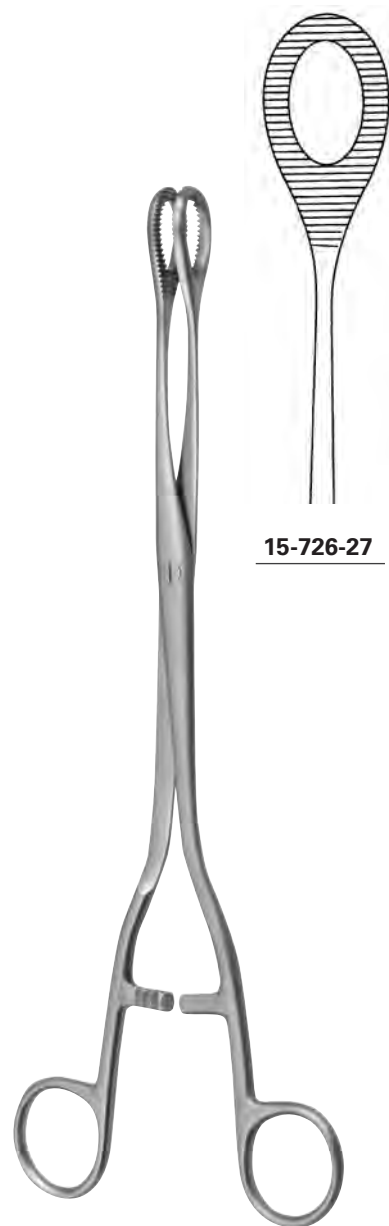
**15-724-28** 28,0 cm, 11"



**15-725-32**

**KELLY**

**15-725-32** 32,0 cm, 12 1/2"



**15-726-27**

**NOTO**

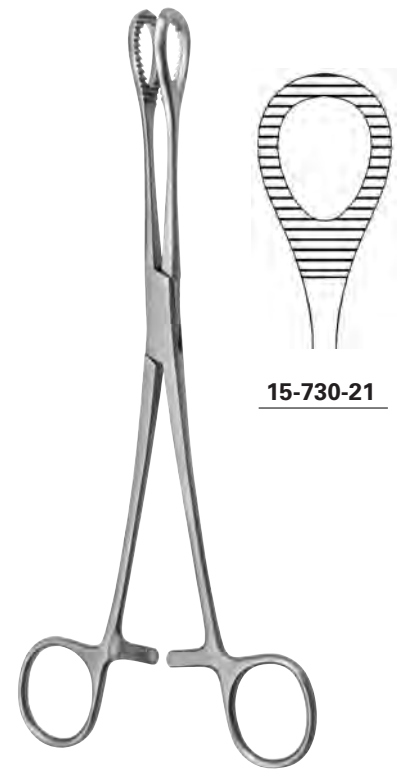
**15-726-27** 27,5 cm, 10  $\frac{3}{4}$ ''



**15-728-25**

**HEYWOOD-SMITH**

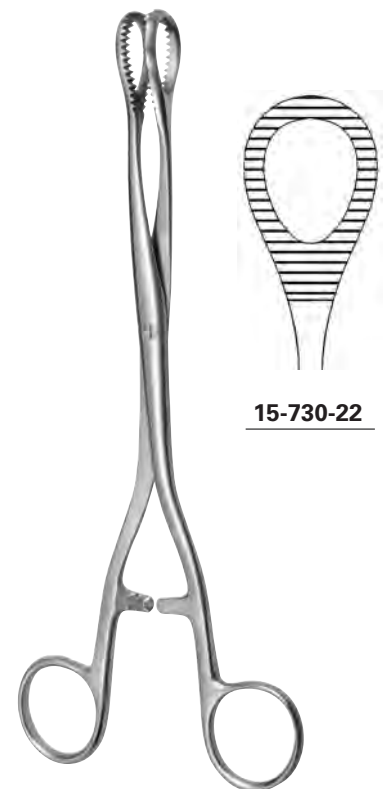
**15-728-25** 25,0 cm, 10''



**15-730-21**

**HEYWOOD-SMITH**

**15-730-21** 20,5 cm, 8''



**15-730-22**

**HEYWOOD-SMITH**

**15-730-22** 21,0 cm, 8  $\frac{1}{4}$ ''



**15-732-25**



**15-732-26**



**15-734-16**

**15-734-17**

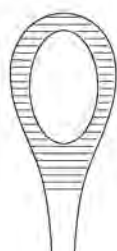
**15-734-18**

**15-732-25** 25,0 cm, 9 3/4"  
**15-732-26** 26,0 cm, 10 1/4"

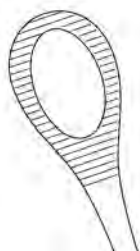
**COLLIN**

**15-734-16** 16,0 cm, 6 1/4"  
**15-734-17** 17,0 cm, 6 3/4"  
**15-734-18** 18,0 cm, 7"





**15-736-18**  
**15-736-20**  
**15-736-25**



**15-737-18**  
**15-737-20**  
**15-737-25**



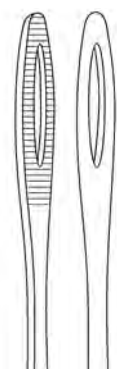
**15-738-18**  
**15-738-20**  
**15-738-25**



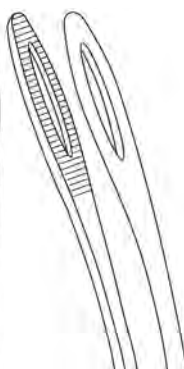
**15-739-18**  
**15-739-20**  
**15-739-25**

### FOERSTER-BALLENGER

**15-736-18 - 15-739-18** 18,0 cm, 7 "  
**15-736-20 - 15-739-20** 20,0 cm, 8 "  
**15-736-25 - 15-739-25** 25,0 cm, 9 3/4 "



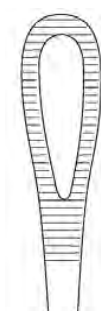
**15-740-25**



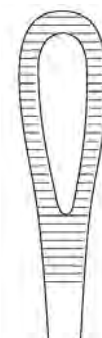
**15-741-25**

### FOERSTER

**15-740-25 - 15-741-25** 25,0 cm, 9 3/4 "



**15-742-18**



**15-742-25**

### RAMPLEY

**15-742-18** 18,0 cm, 7 "  
**15-742-25** 25,0 cm, 9 3/4 "



**15-744-16**

**WILLIAMS**

**15-744-16** 16,0 cm, 6 ¼"



**15-744-24**

**BONNEY**

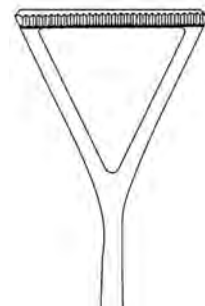
**15-744-24** 24,0 cm, 9 ½"



**15-750-14**  
**15-750-18**  
**15-750-20**

**DUVAL**

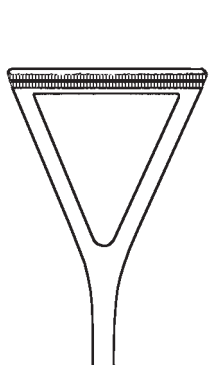
**15-750-14** 14,0 cm, 5 ½"  
**15-750-18** 18,0 cm, 7"  
**15-750-20** 20,0 cm, 8"



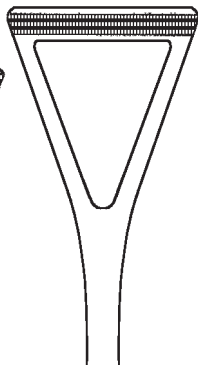
**15-752-20**  
**15-752-23**

**DUVAL**

**15-752-20** 20,0 cm, 8"  
**15-752-23** 23,0 cm, 9"



**15-751-19**



**15-751-23**



**15-753-20**



**DUVAL**

**15-751-19** 19,5 cm, 7 3/4"

**15-751-23** 23,0 cm, 9"

**DUVAL**

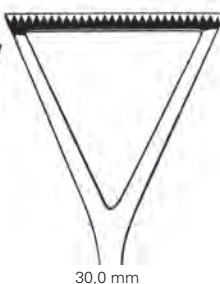
**15-753-20** 20,0 cm, 8"



**15-752-01**



**15-752-02**



**15-752-03**



**15-754-14**



**DUVAL-COLLIN**

**15-752-01 - 15-752-03** 19,0 cm, 7 1/2"

**COLLIN**

**15-754-14** 14,0 cm, 5 1/2"

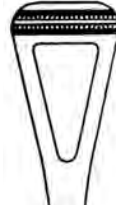


**SCHEIBE**

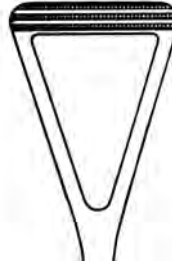
<b>15-755-18</b>	18,0 cm, 7 "
<b>15-755-20</b>	20,0 cm, 8 "
<b>15-755-23</b>	23,0 cm, 9 "



**15-755-18**



**15-755-20**



**15-755-23**



**15-756-15**  
**15-756-20**



**PENNINGTON**

<b>15-756-15</b>	15,0 cm, 6 "
<b>15-756-20</b>	20,0 cm, 8 "



**15-758-20**



**LOCKWOOD**

<b>15-758-20</b>	20,0 cm, 8 "
------------------	--------------



**BABCOCK**

<b>15-760-16</b>	16,0 cm, 6 ¼ "
<b>15-760-18</b>	18,0 cm, 7 "
<b>15-760-20</b>	20,0 cm, 8 "
<b>15-760-24</b>	24,0 cm, 9 ½ "
<b>15-760-36</b>	36,0 cm, 14 "
<b>15-760-40</b>	40,0 cm, 16 "



**15-762-16**

**15-762-20**

**15-762-22**



**BABCOCK**

<b>15-762-16</b>	16,0 cm, 6 1/4"
<b>15-762-20</b>	20,5 cm, 8"
<b>15-762-22</b>	22,0 cm, 8 3/4"



**15-764-16**

**15-764-20**



**BABCOCK**

<b>15-764-16</b>	16,0 cm, 6 1/4"
<b>15-764-20</b>	20,5 cm, 8"



**15-765-02**

**15-765-03**

**ALLIS**

<b>15-765-02 - 15-765-03</b>	15,5 cm, 6 1/8"
------------------------------	-----------------



**15-766-12**

**BABY-ALLIS**

<b>15-766-12</b>	12,5 cm, 5"
------------------	-------------



**15-766-14**

**ALLIS**

<b>15-766-14</b>	15,0 cm, 6"
------------------	-------------



5 x 6



**15-766-15**  
**15-766-19**  
**15-766-22**  
**15-766-25**



**15-768-16**  
**15-768-20**  
**15-768-22**  
**15-768-25**  
**15-768-30**



**ALLIS**

<b>15-766-15</b>	15,0 cm, 6"
<b>15-766-19</b>	19,0 cm, 7 1/2"
<b>15-766-22</b>	22,0 cm, 8 3/4"
<b>15-766-25</b>	25,0 cm, 9 3/4"

**ALLIS**

<b>15-768-16</b>	16,0 cm, 6 1/4"
<b>15-768-20</b>	20,0 cm, 8"
<b>15-768-22</b>	22,0 cm, 8 3/4"
<b>15-768-25</b>	25,0 cm, 9 3/4"
<b>15-768-30</b>	30,0 cm, 11 3/4"



6 x 7



**15-770-20**



5 x 6



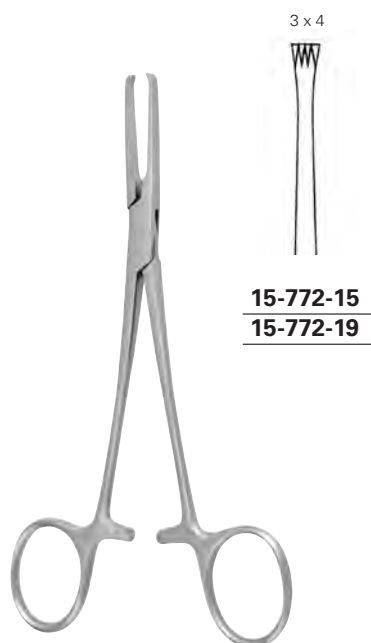
**15-770-21**  
**15-770-22**

**THOMS-ALLIS**

<b>15-770-20</b>	20,0 cm, 8"
------------------	-------------

**ALLIS**

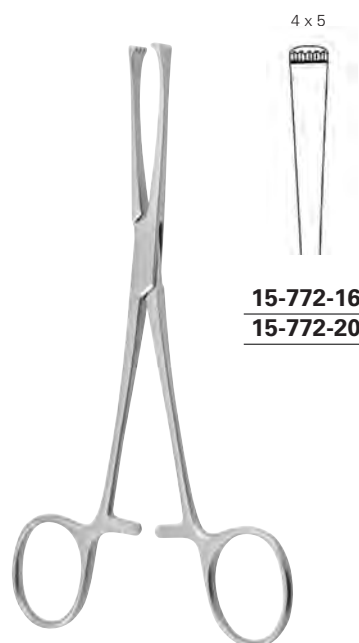
<b>15-770-21</b>	20,0 cm, 8"
<b>15-770-22</b>	22,0 cm, 8 3/4"



**15-772-15**  
**15-772-19**

**JUDD-ALLIS**

**15-772-15** 15,5 cm, 6 1/8"  
**15-772-19** 19,0 cm, 7 1/2"



**15-772-16**  
**15-772-20**

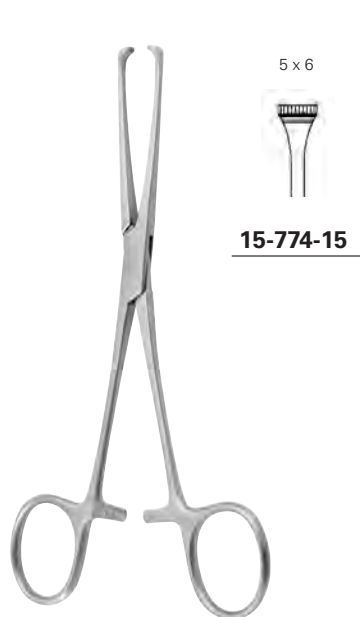
**LOCKWOOD-ALLIS**

**15-772-16** 16,0 cm, 6 1/4"  
**15-772-20** 20,0 cm, 8"



**LITTLEWOOD**

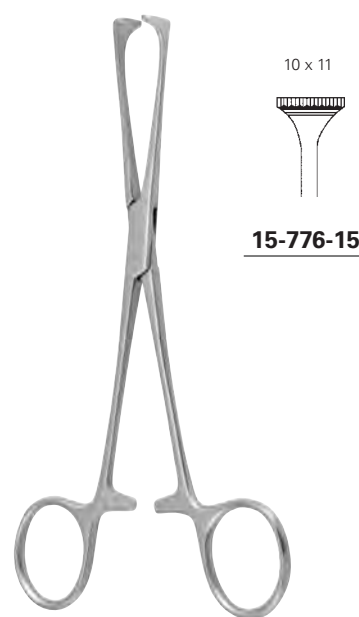
**15-773-19** 19,0 cm, 7 1/2"



**15-774-15**

**BOYS-ALLIS**

**15-774-15** 15,0 cm, 6"



**15-776-15**

**ALLIS-ADAIR**

**15-776-15** 16,0 cm, 6 1/4"



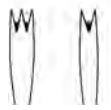
**15-778-13**

**TUFFIER**

**15-778-13** 13,0 cm, 5 1/8"



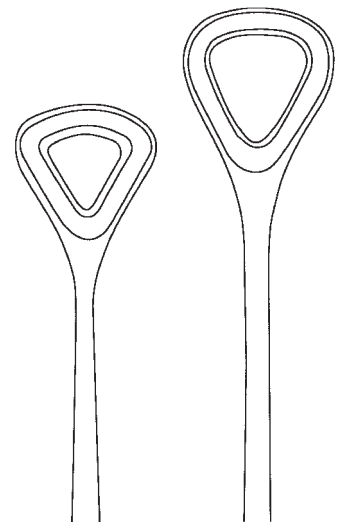
2 x 3



**15-780-13**

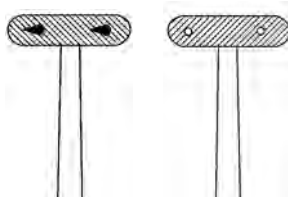
**CHAPUT**

**15-780-13** 13,0 cm, 5 1/8"



**15-788-22**

**15-788-24**



**15-786-14**

**15-784-19**

**WILLET-MARTEL**

**15-786-14** 14,0 cm, 5 1/2"

**15-784-19** 18,5 cm, 7 1/4"



**LUER**

**15-788-22** 22,0 cm, 8 3/4"

**15-788-24** 24,5 cm, 9 2/3"





### BACKHAUS-KOCHER

**15-800-13** 13,0 cm, 5 1/8"

Kabelhalterung bis Ø 5,0 mm  
Holder for cable up to Ø 5,0 mm  
Porta cable nastaa Ø 5,0 mm  
Porta cavo fino a Ø 5,0 mm



**15-801-08**  
**15-801-11**  
**15-801-13**  
**15-801-15**

### BACKHAUS

**15-801-08** 8,0 cm, 3 1/8"  
**15-801-11** 11,0 cm, 4 3/8"  
**15-801-13** 13,0 cm, 5 1/8"  
**15-801-15** 15,0 cm, 6"

Schlauchhalterung bis Ø 13,0 mm  
Holder for rubber tube up to Ø 13,0 mm  
Porta tubo nastaa Ø 13,0 mm  
Porta tubo fino a Ø 13,0 mm

Schlauchhalterung bis Ø 15,0 mm  
Holder for rubber tube up to Ø 15,0 mm  
Porta tubo nastaa Ø 15,0 mm  
Porta tubo fino a Ø 15,0 mm



### ROBIN

**15-802-13** 13,0 cm, 5 1/8"



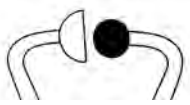
### ROBIN

**15-802-14** 13,0 cm, 5 1/8"



### BACKHAUS

**15-803-11** 11,0 cm, 4 3/8"



**BALL & SOCKET**

**15-805-11** 11,0 cm, 4  $\frac{3}{8}$  "  
**15-805-14** 14,0 cm, 5  $\frac{1}{2}$  "



**BERNHARD**

**15-807-16** 16,0 cm, 6  $\frac{1}{4}$  "



**ROEDER**

**15-809-13** 13,0 cm, 5  $\frac{1}{8}$  "  
**15-809-15** 15,0 cm, 6 "



**LANE**

**15-811-13** 13,0 cm, 5  $\frac{1}{8}$  "  
**15-811-15** 15,0 cm, 6 "  
**15-811-20** 20,0 cm, 8 "



**DOYEN**

**15-813-18** 18,0 cm, 7 "



**SCHAEDEL**

**15-816-09** 9,0 cm, 3  $\frac{1}{2}$  "



**SCHAEDEL**

**15-817-09** 9,0 cm, 3  $\frac{1}{2}$  "



### JONES

**15-819-05** 5,5 cm, 2 1/8"  
**15-819-09** 9,0 cm, 3 1/2"



### PEERS-BERTRAM

**15-821-14** 14,5 cm, 5 3/4"



### LORNA (EDNA)

**15-823-10** 9,5 cm, 3 3/4"  
**15-823-13** 13,0 cm, 5 1/8"



### TOHOKU

**15-825-10** 10,0 cm, 4"  
**15-825-13** 13,0 cm, 5 1/8"

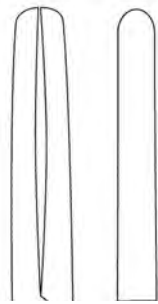


**15-827-13** 13,0 cm, 5 1/8"



### HOFF

**15-829-10** 10,0 cm, 4"  
**15-829-12** 12,0 cm, 4 3/4"  
**15-829-14** 14,0 cm, 5 1/2"



**15-840-16**  
**15-840-18**  
**15-840-20**  
**15-840-24**

<b>15-840-16</b>	16,0 cm, 6 ¼"
<b>15-840-18</b>	18,0 cm, 7"
<b>15-840-20</b>	20,0 cm, 8"
<b>15-840-24</b>	24,0 cm, 9 ½"



**15-842-14**  
**15-842-16**  
**15-842-20**

**BERLIN**

<b>15-842-14</b>	14,0 cm, 5 ½"
<b>15-842-16</b>	16,5 cm, 6 ½"
<b>15-842-20</b>	20,0 cm, 8"



**15-844-15**



**15-844-18**

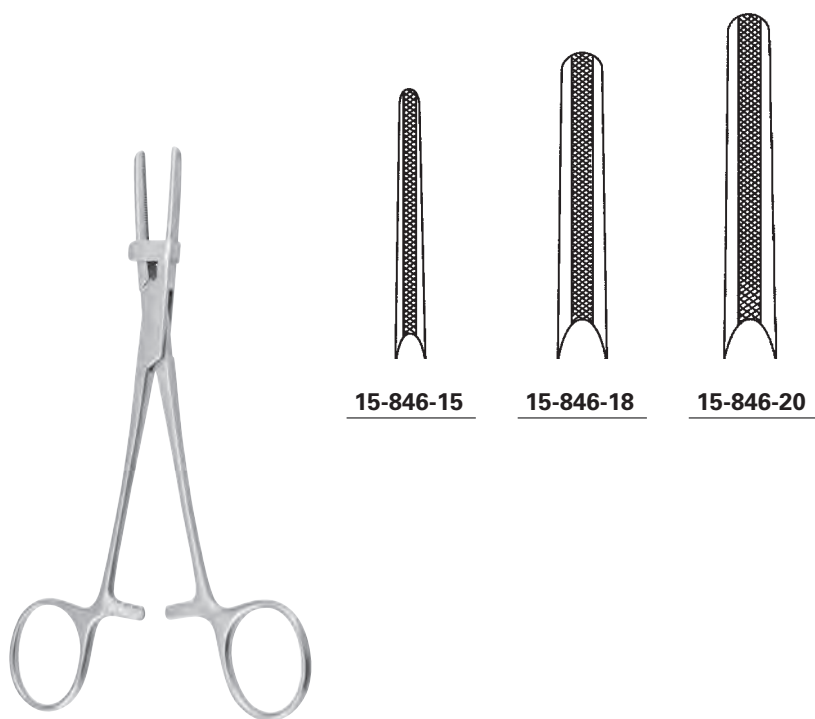


**15-844-19**



**15-844-20**

<b>15-844-15</b>	15,0 cm, 6"
<b>15-844-18</b>	18,0 cm, 7"
<b>15-844-19</b>	19,0 cm, 7 ½"
<b>15-844-20</b>	20,0 cm, 8"



**15-846-15**

**15-846-18**

**15-846-20**

<b>15-846-15</b>	15,0 cm, 6 "
<b>15-846-18</b>	18,0 cm, 7 "
<b>15-846-20</b>	20,0 cm, 8 "



**15-849-16** 16,0 cm, 6 ¼ "



**GUNAR-HEY**

**15-848-18** 18,0 cm, 7 "



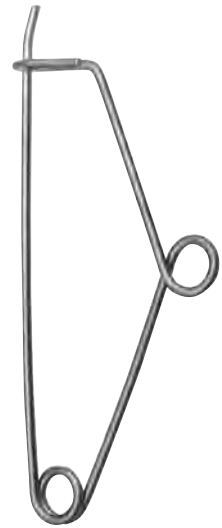
**BUNT**

**15-851-12** 12,0 cm, 4  $\frac{3}{4}$ ''



**MAYO**

**15-851-13** 13,0 cm, 5  $\frac{1}{8}$ ''



**MAYO**

**15-851-14** 14,0 cm, 5  $\frac{1}{2}$ ''

# 16

Wundhaken

Retractors

Separadores

Divaricatori





**VOLKMANN**

**16-001-01 - 16-003-08** 22,0 cm, 8 3/4"



**16-001-01**



**16-002-01**



**16-003-01**



**16-001-02**



**16-002-02**



**16-003-02**



**16-001-03**



**16-002-03**



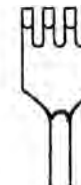
**16-003-03**



**16-001-04**



**16-002-04**



**16-003-04**



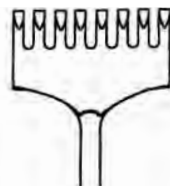
**16-001-06**



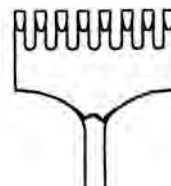
**16-002-06**



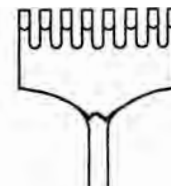
**16-003-06**



**16-001-08**



**16-002-08**



**16-003-08**

scharf  
sharp  
agudo  
acuto

halbscharf  
semi-sharp  
semi-agudo  
semi-acuto

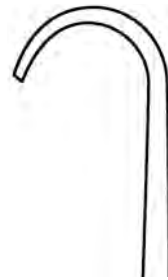
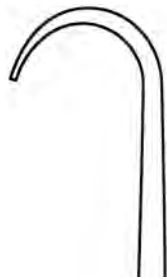
stumpf  
blunt  
romo  
smusso



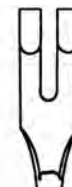


**MARTIN**

**16-001-12 - 16-003-16** 22,5 cm, 8 3/4 "



**16-001-12**



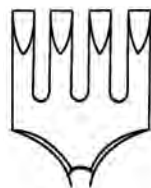
**16-003-12**



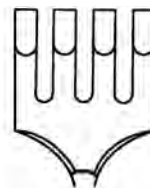
**16-001-13**



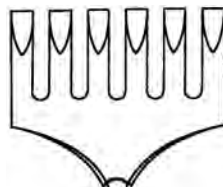
**16-003-13**



**16-001-14**

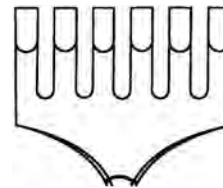


**16-003-14**



**16-001-16**

scharf  
 sharp  
 agudo  
 acuto



**16-003-16**

stumpf  
 blunt  
 romo  
 smusso



**KOCHER**

16-005-01 - 16-007-08 22,0 cm, 8 3/4"



16-005-01



16-006-01



16-007-01



16-005-02



16-006-02



16-007-02



16-005-03



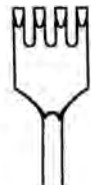
16-006-03



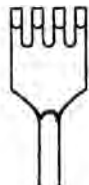
16-007-03



16-005-04



16-006-04



16-007-04



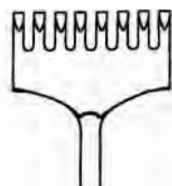
16-005-06



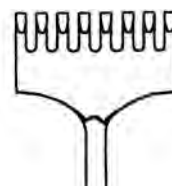
16-006-06



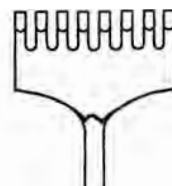
16-007-06



16-005-08



16-006-08



16-007-08

scharf  
sharp  
agudo  
acuto

halbscharf  
semi-sharp  
semi-agudo  
semi-acuto

stumpf  
blunt  
romo  
smusso



**16-008-01**



**16-009-01**



**16-008-02**



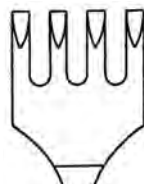
**16-009-02**



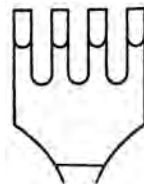
**16-008-03**



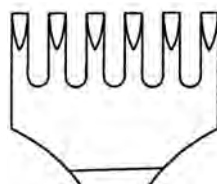
**16-009-03**



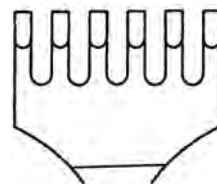
**16-008-04**



**16-009-04**



**16-008-06**



**16-009-06**

**VOLKMANN**

**16-008-01 - 16-009-06** 22,0 cm, 8 3/4"

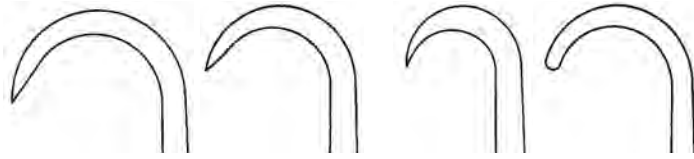
scharf  
sharp  
agudo  
acuto

stumpf  
blunt  
romo  
smusso



**VOLKMANN**

<b>16-010-01</b>	22,0 cm, 8 3/4"
<b>16-010-02</b>	22,0 cm, 8 3/4"
<b>16-010-03</b>	20,5 cm, 8"
<b>16-011-01</b>	22,0 cm, 8 3/4"
<b>16-012-01</b>	21,5 cm, 8 1/2"
<b>16-012-12</b>	24,5 cm, 9 2/3"
<b>16-013-01</b>	21,5 cm, 8 1/2"



**16-010-01**

scharf  
sharp  
agudo  
acuto

**16-010-02**

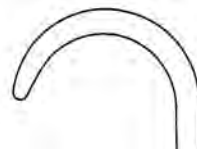
scharf  
sharp  
agudo  
acuto

**16-010-03**

scharf  
sharp  
agudo  
acuto

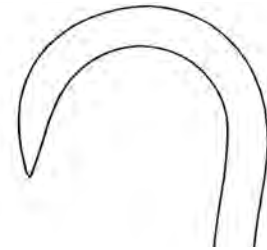
**16-011-01**

stumpf  
blunt  
romo  
smusso



**16-013-01**

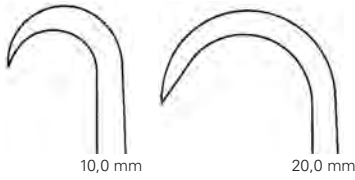
stumpf  
blunt  
romo  
smusso



**16-012-01**

**16-012-12**

scharf  
sharp  
agudo  
acuto



**16-013-10**

scharf  
sharp  
agudo  
acuto

**16-013-20**

scharf  
sharp  
agudo  
acuto

**16-013-10 - 16-013-20** 19,0 cm, 7 1/2"



**LAMBOTTE**

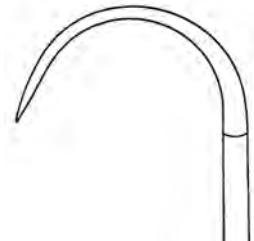
**16-013-27** 27,0 cm, 10 3/4"



46 x 55 mm

**16-015-14**

stumpf  
 blunt  
 romo  
 smusso



28 x 40 mm

**16-015-18**

halbscharf  
 semi-sharp  
 semi-agudo  
 semi-acuto



40 x 30 mm

**16-014-08**

scharf  
 sharp  
 agudo  
 acuto



40 x 30 mm

**16-015-08**

stumpf  
 blunt  
 romo  
 smusso



**KOERTE**

**16-015-14** 23,0 cm, 9"



**KOERTE**

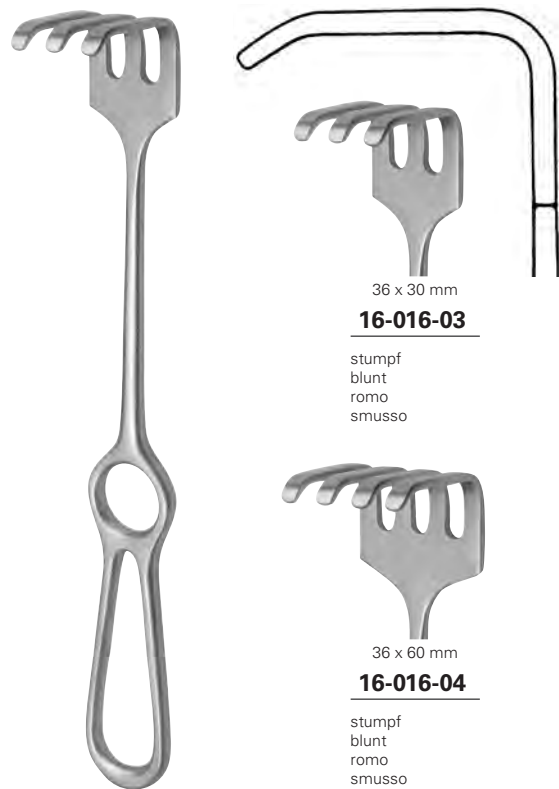
**16-015-18** 28,0 cm, 11"

**16-014-08 - 16-015-08** 24,5 cm, 9 2/3"



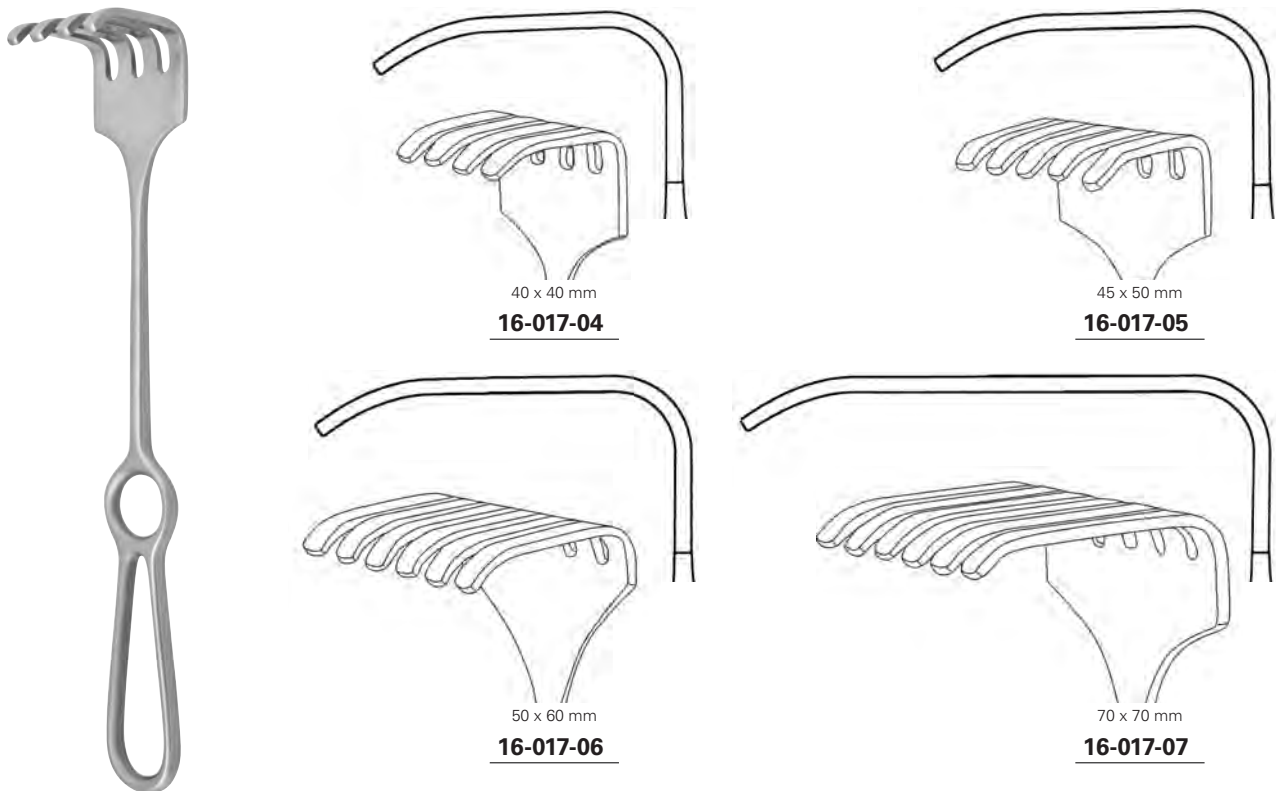
**WASSMUND**

**16-016-02** 20,5 cm, 8"



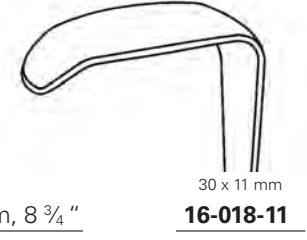
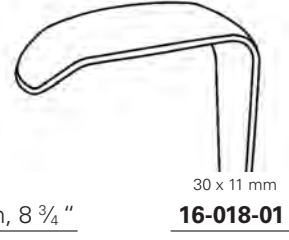
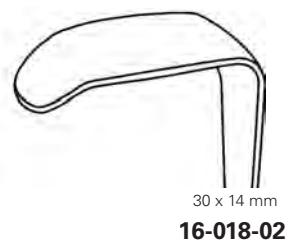
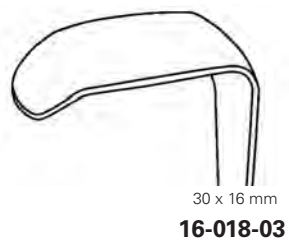
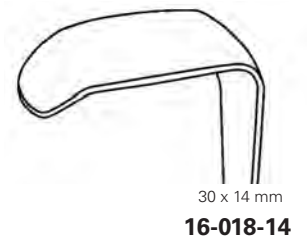
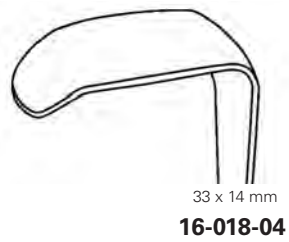
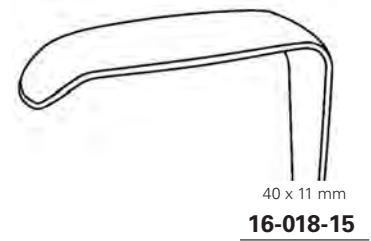
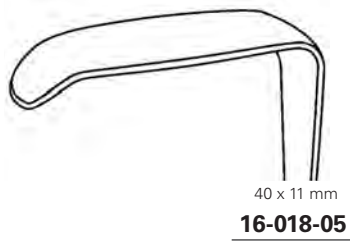
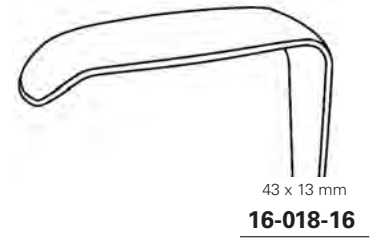
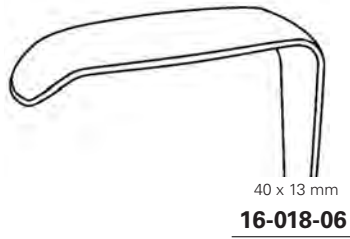
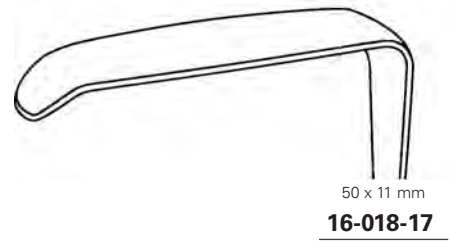
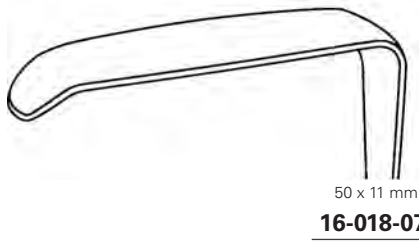
**OLLIER**

**16-016-03 - 16-016-04** 23,0 cm, 9"



**ISRAEL**

**16-017-04 - 16-017-07** 25,5 cm, 10"



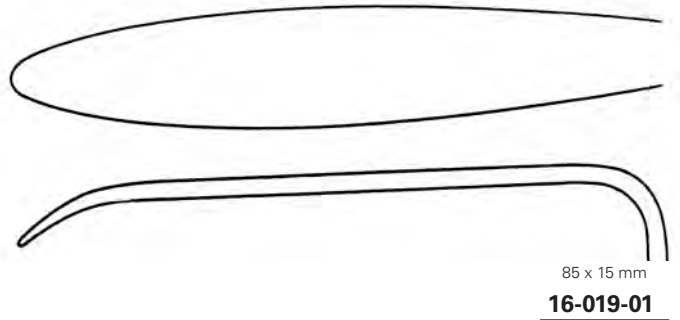
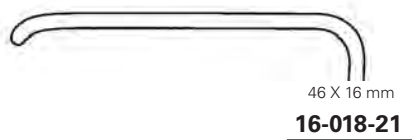
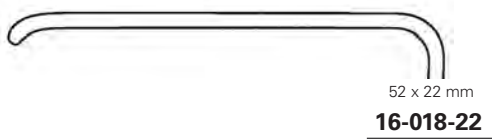
**LANGENBECK**

**16-018-01 - 16-018-07** 22,5 cm, 8 3/4"



**LANGENBECK**

**16-018-11 - 16-018-17** 22,5 cm, 8 3/4"



**SAUERBRUCH**

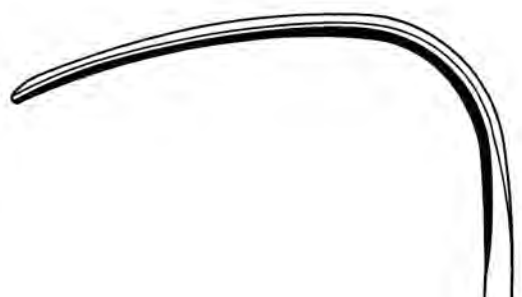
**16-018-21 - 16-018-23** 22,5 cm, 8 3/4"



**LANGENBECK**

**16-019-01** 22,5 cm, 8 3/4"





65 x 20 mm

**16-020-01**



55 x 20 mm

**16-020-02**



## LANGENBECK

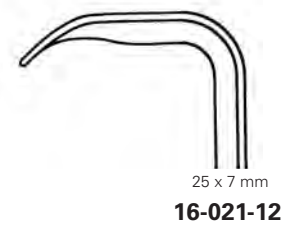
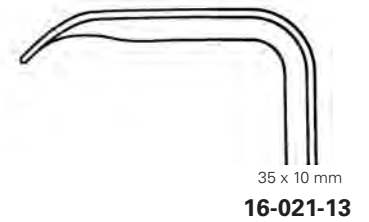
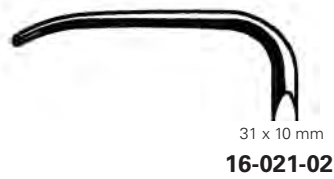
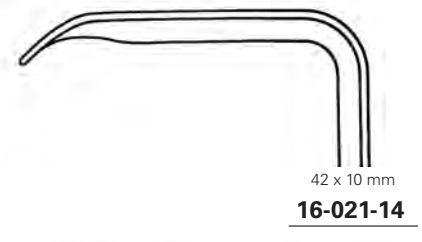
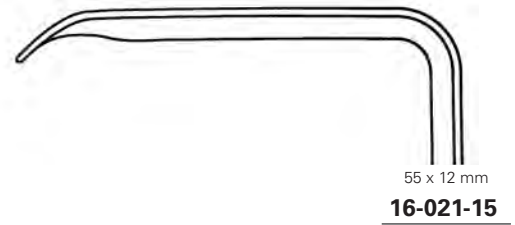
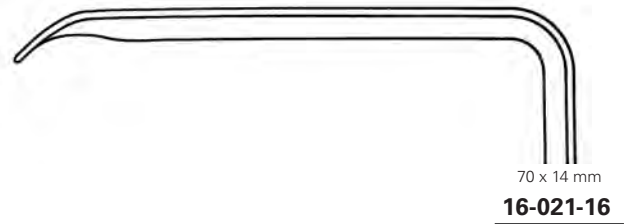
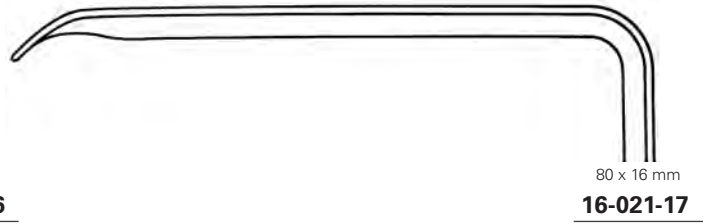
**16-020-01** 21,0 cm, 8 ¼"  
**16-020-02** 22,0 cm, 8 ¾"



Kinnhalter  
Chin retractor  
Gancho de mentón  
Guancio per mento

## OBWEGESER

**16-021-00** 16,5 cm, 6 ½"



Weichteilhaken  
Soft tissue retractors  
Separadores para partes blandes  
Divaricatori per tessuti molli

**OBWEGESER**

**16-021-01 - 16-021-06** 21,5 cm, 8 ½"

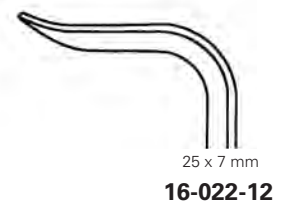
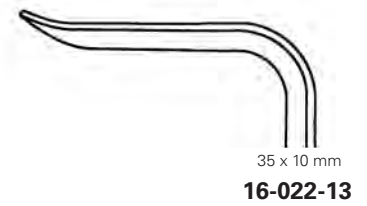
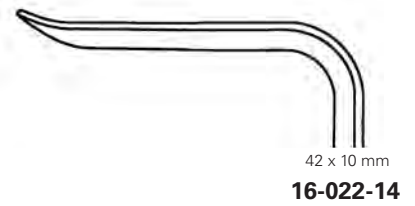
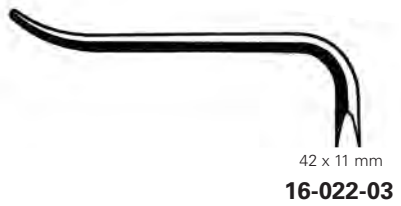
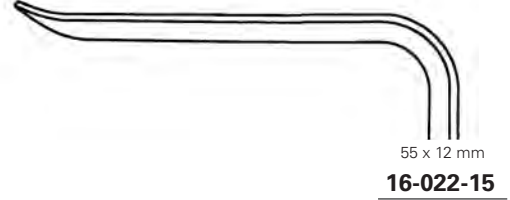
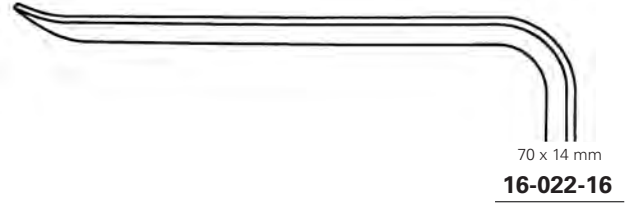
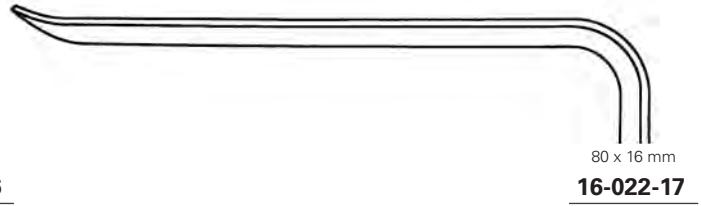


Weichteilhaken  
Soft tissue retractors  
Separadores para partes blandes  
Divaricatori per tessuti molli

**OBWEGESER**

**16-021-11 - 16-021-17** 24,0 cm, 9 ½"





Weichteilhaken  
 Soft tissue retractors  
 Separadores para partes blandas  
 Divaricatori per tessuti molli

**OBWEGESER**

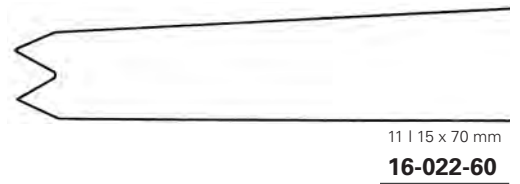
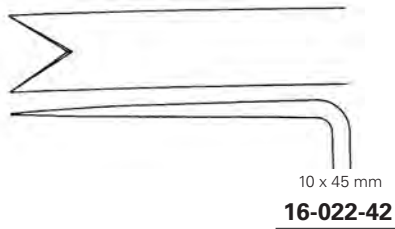
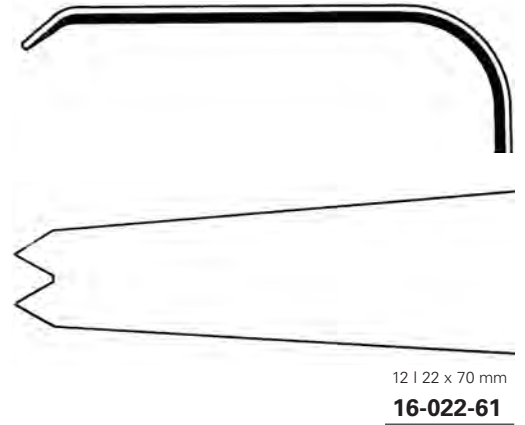
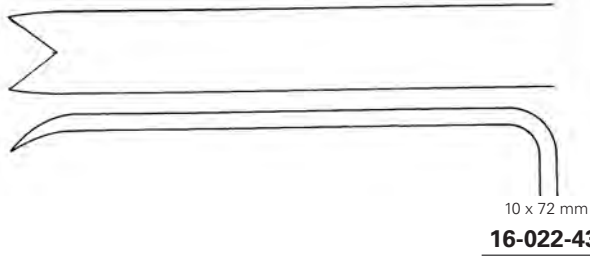
**16-022-01 - 16-022-06** 21,5 cm, 8 1/2"



Weichteilhaken  
 Soft tissue retractors  
 Separadores para partes blandas  
 Divaricatori per tessuti molli

**OBWEGESER**

**16-022-11 - 16-022-17** 24,0 cm, 9 1/2"



Ramushaken  
Ramus retractors  
Separadores para el ramo  
Separatore per ramo

**OBWEGESER**

**16-022-42 - 16-022-43** 22,0 cm, 8 3/4"



Ramushaken  
Ramus retractors  
Separadores para el ramo  
Separatore per ramo

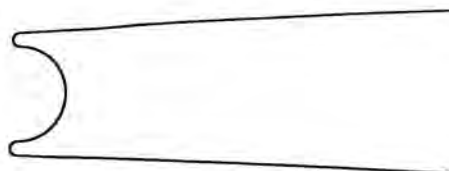
**OBWEGESER**

**16-022-60 - 16-022-61** 24,5 cm, 9 3/4"



15 | 22 x 70 mm

**16-022-70**



55 x 14 mm

**16-023-02**



40 x 12 mm

**16-023-01**



Weisheitszahnhaken  
Third molar retractor  
Separador para muela del juicio  
Separatore per il dente del giudizio

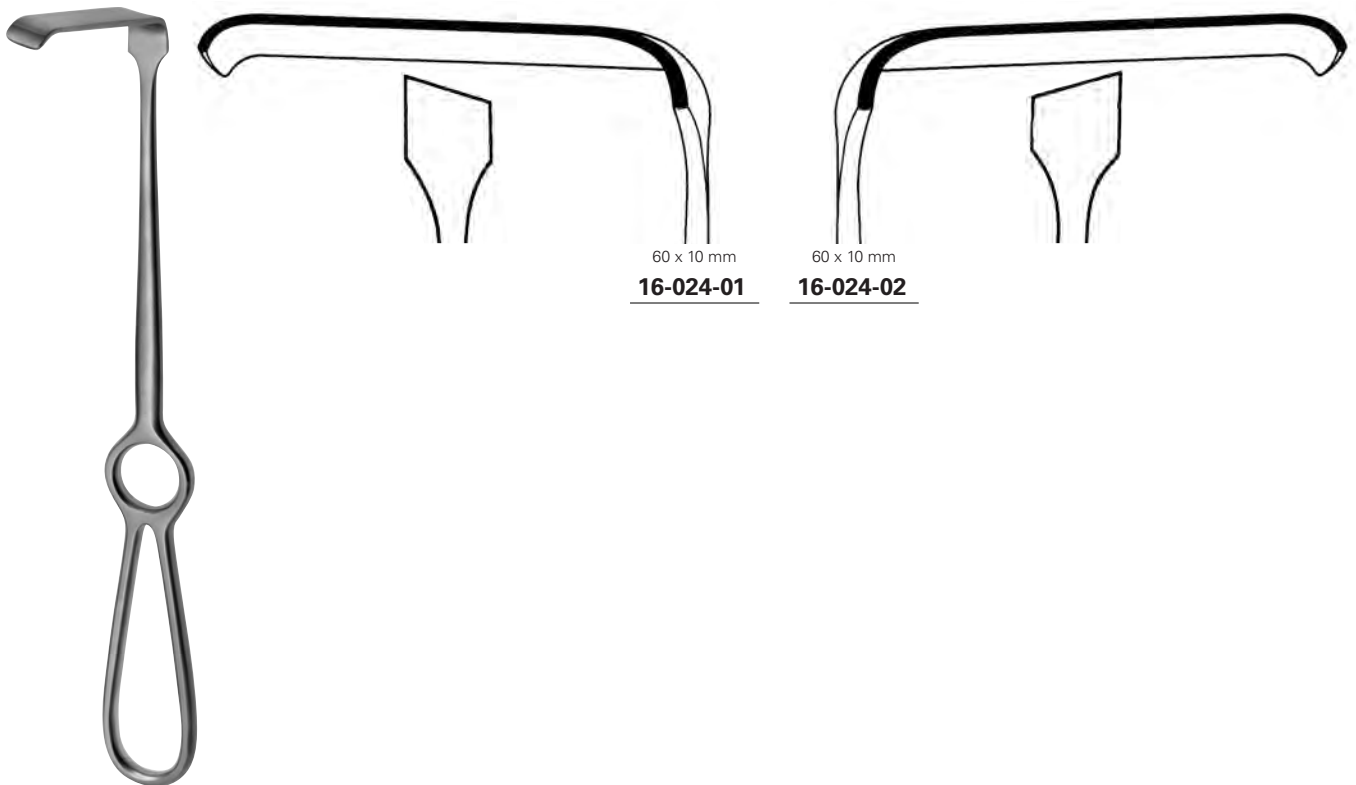
### OBWEGESER

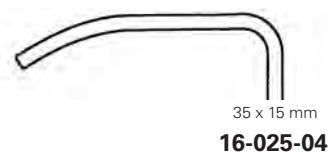
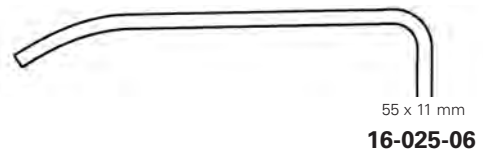
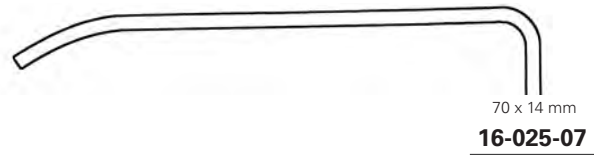
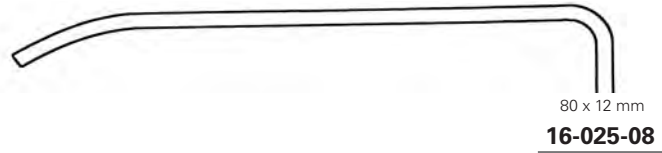
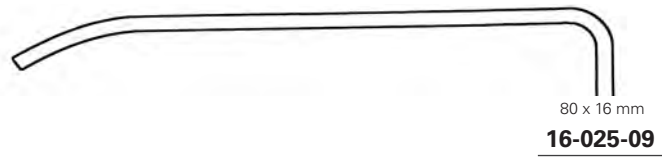
**16-022-70** 24,0 cm, 9 ½"



### DOCKHORN

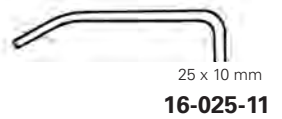
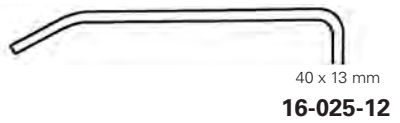
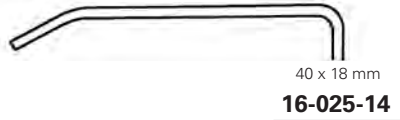
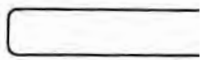
**16-023-01 - 16-023-02** 21,0 cm, 8 ¼"





**KOCHER-LANGENBECK**

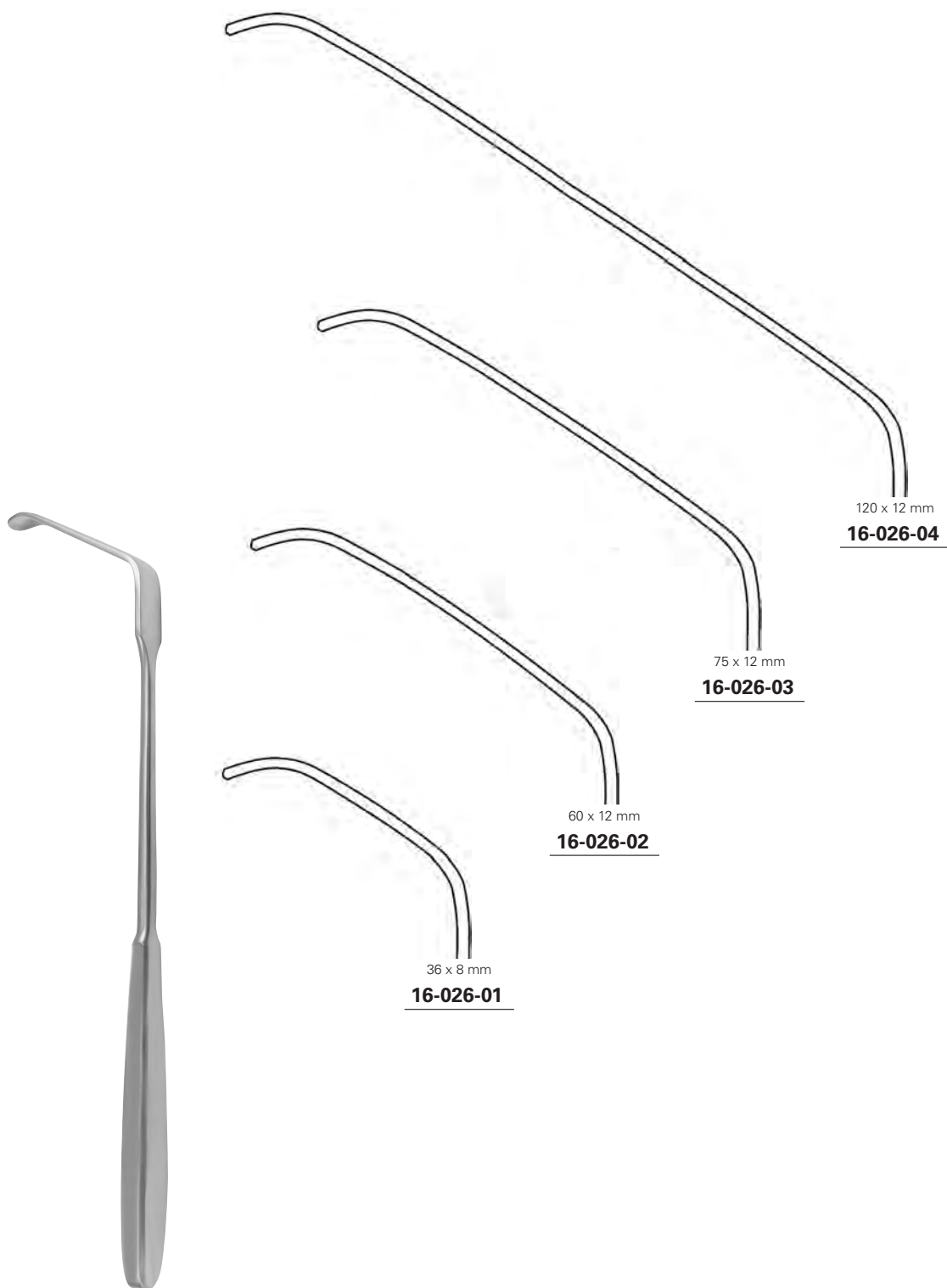
**16-025-00 - 16-025-09** 21,5 cm, 8 ½"



**KOCHER-LANGENBECK**

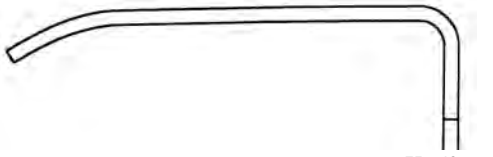
**16-025-11 - 16-025-18** 21,5 cm, 8 ½"



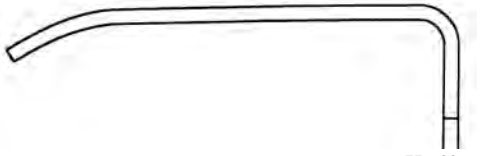


## ZENKER

<b>16-026-01</b>	25,0 cm, 10"
<b>16-026-02</b>	26,0 cm, 10 1/2"
<b>16-026-03</b>	27,0 cm, 10 3/4"
<b>16-026-04</b>	29,0 cm, 11 1/2"



75 x 40 mm  
**16-027-05**



75 x 30 mm  
**16-027-04**



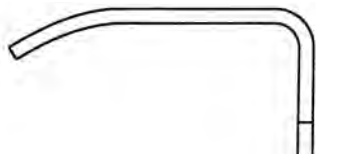
60 x 25 mm  
**16-027-03**



90 x 50 mm  
**16-028-01**



60 x 20 mm  
**16-027-02**

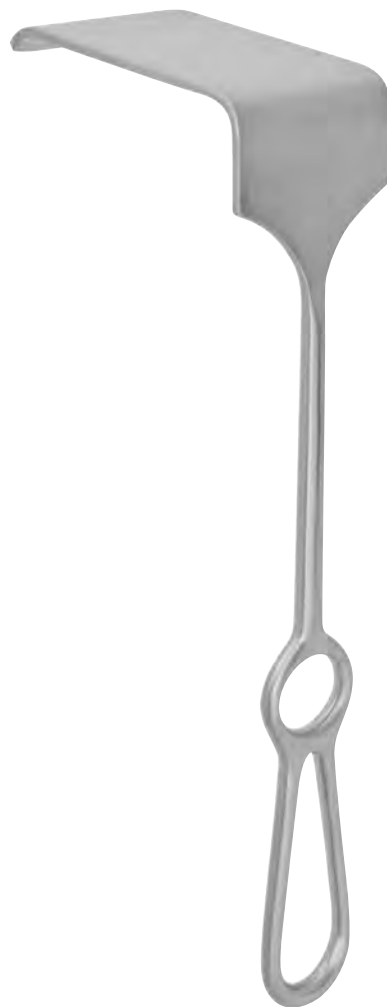


40 x 18 mm  
**16-027-01**



**KOCHER**

**16-027-01 - 16-027-05** 23,0 cm, 9"



**MIKULICZ**

**16-028-01** 26,0 cm, 10 1/2"



<b>16-028-02</b>	90 x 35 mm
<b>16-028-03</b>	120 x 50 mm
<b>16-028-04</b>	155 x 50 mm
<b>16-028-05</b>	180 x 50 mm

## MIKULICZ

**16-028-02 - 16-028-05** 26,0 cm, 10 1/2"

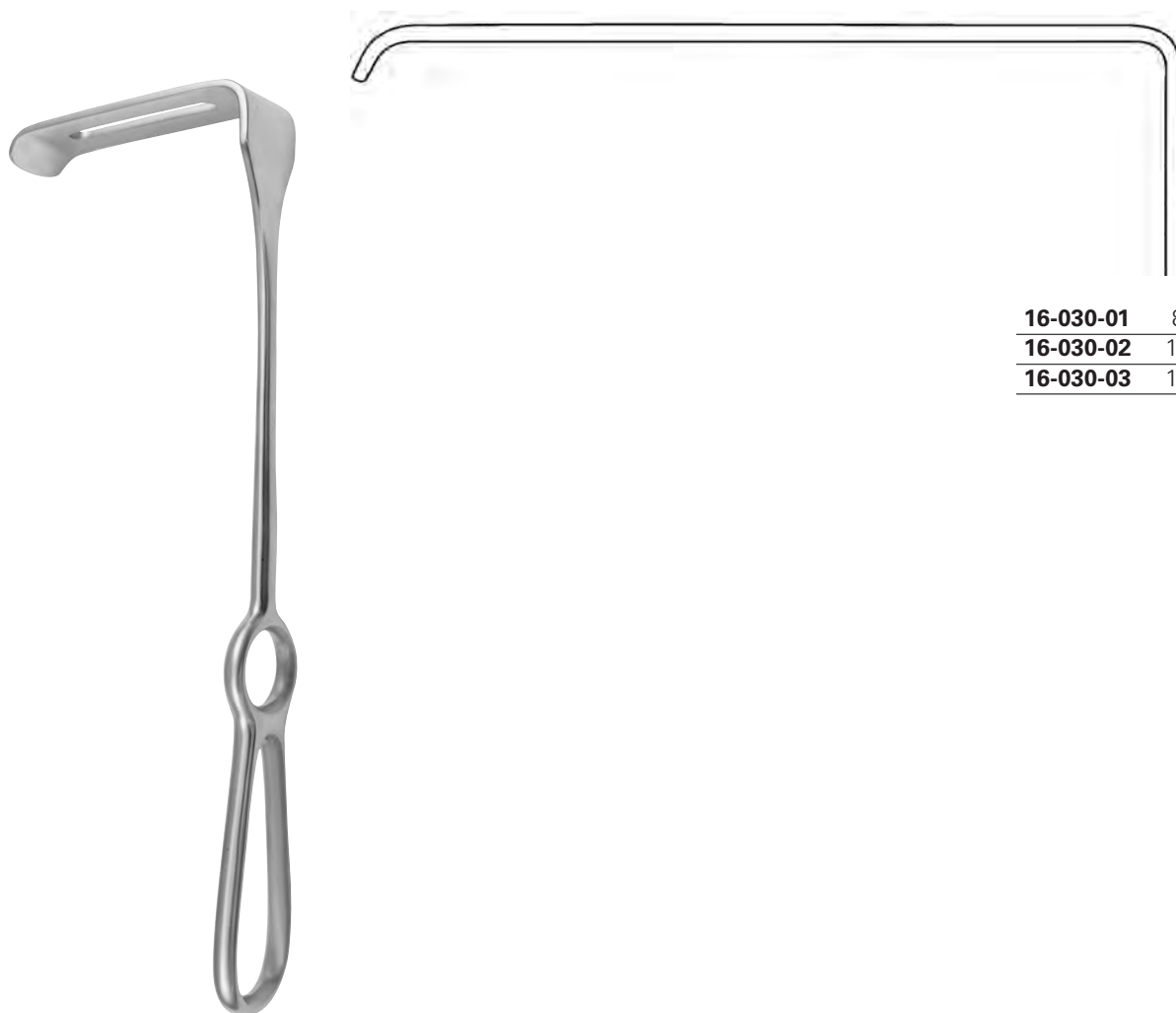


**SAUERBRUCH**

**16-029-01 - 16-029-03** 22,5 cm, 8 3/4"

**SAUERBRUCH**

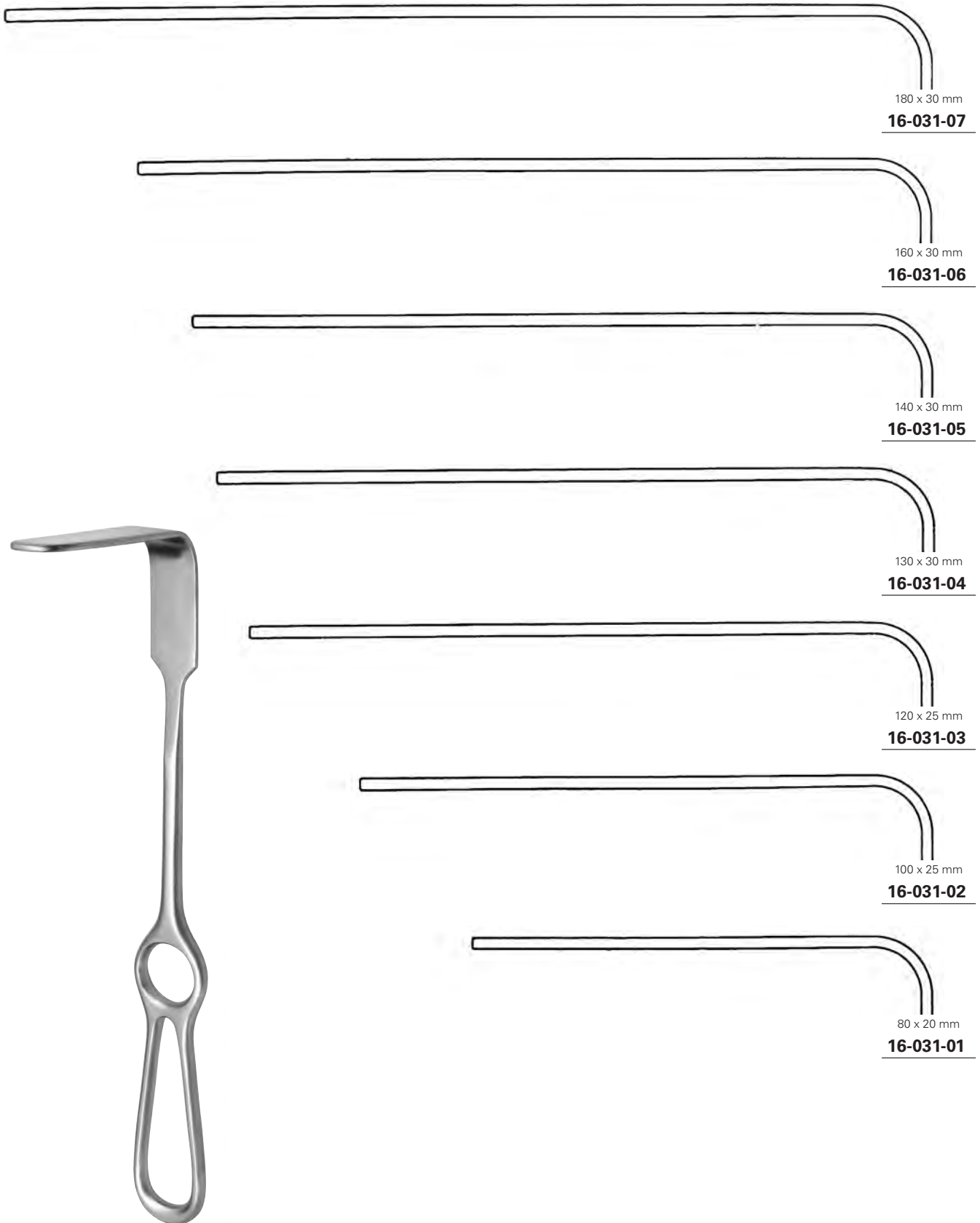
**16-029-26** 25,0 cm, 10"



<b>16-030-01</b>	82 x 22 mm
<b>16-030-02</b>	115 x 38 mm
<b>16-030-03</b>	115 x 65 mm

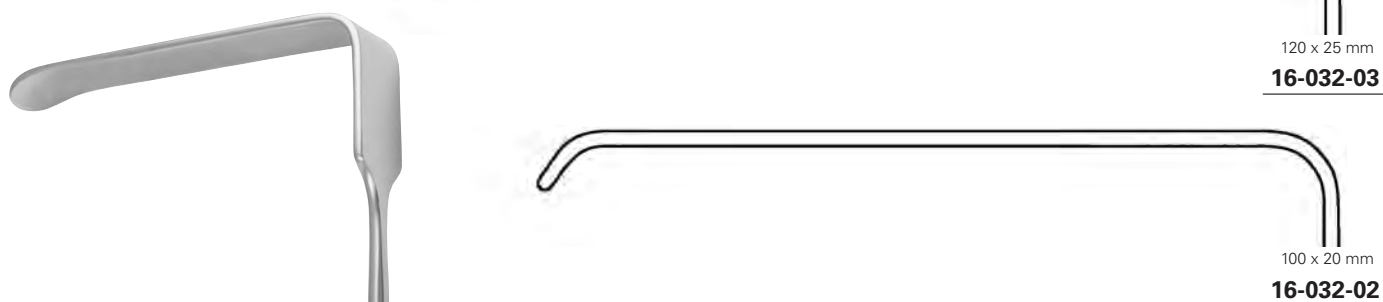
## CORYLLOS

**16-030-01 - 16-030-03** 24,0 cm, 9 ½"



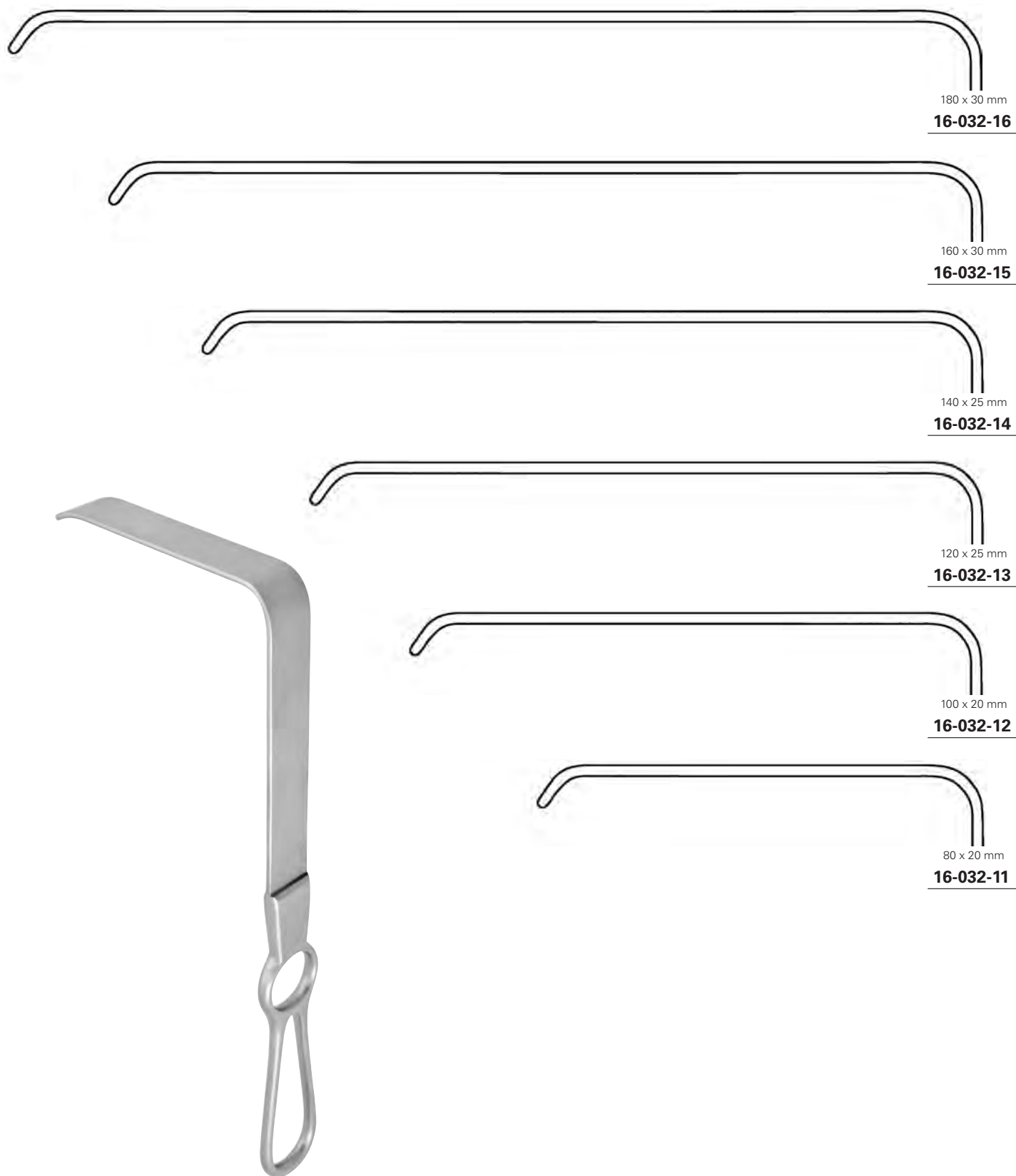
**BRUNNER**

**16-031-01 - 16-031-07** 25,5 cm, 10 "



**BRUNNER**

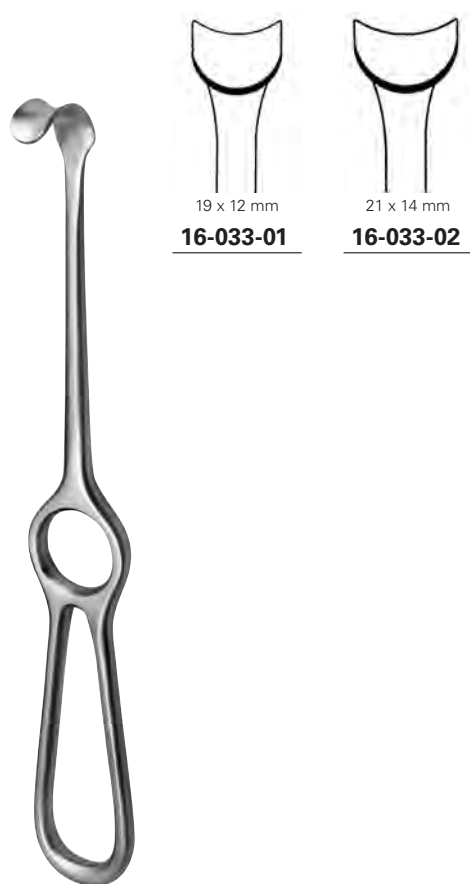
**16-032-01 - 16-032-06** 25,0 cm, 10 "



**BRUNNER**

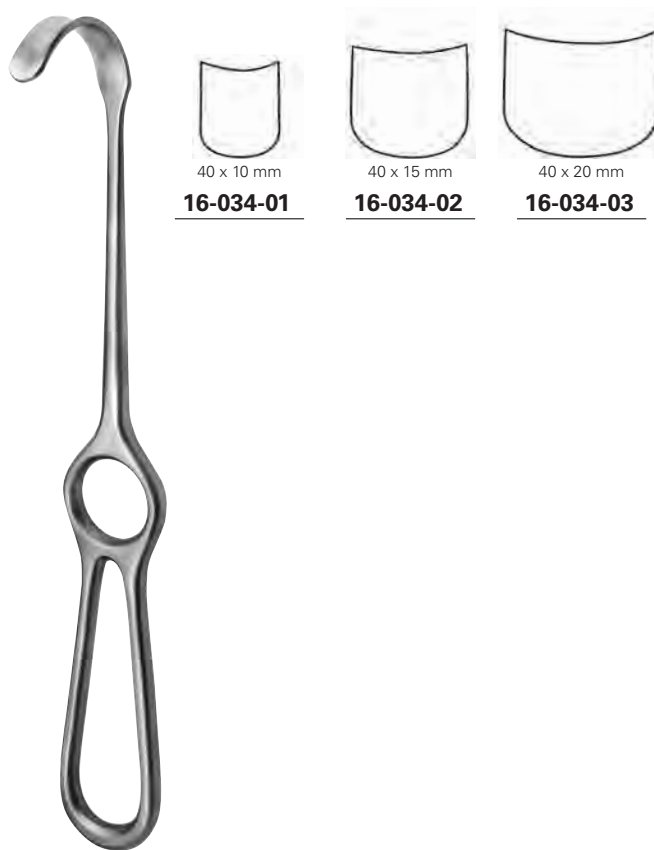
**16-032-11 - 16-032-16** 25,0 cm, 10 "





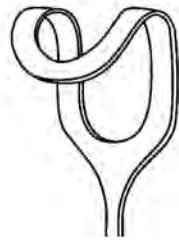
**KOCHER**

**16-033-01 - 16-033-02** 21,0 cm, 8 ¼"



**KOCHER**

**16-034-01 - 16-034-03** 22,0 cm, 8 ¾"



26 x 30 mm

**16-035-03**



20 x 22 mm

**16-035-02**



14 x 17 mm

**16-035-01**



**MIDDELDORPF**

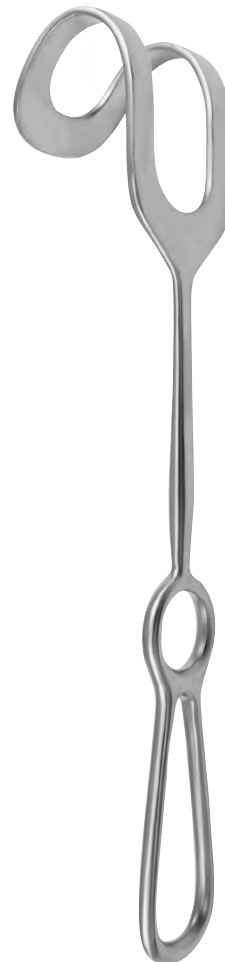
<b>16-035-01</b>	21,5 cm, 8 1/2 "
<b>16-035-02</b>	22,0 cm, 8 3/4 "
<b>16-035-03</b>	23,5 cm, 9 1/2 "



**16-036-01** 45 x 45 mm

**16-036-02** 45 x 50 mm

**16-036-03** 55 x 70 mm



**MIDDELDORPF**

<b>16-036-01</b>	25,5 cm, 10 "
<b>16-036-02</b>	25,5 cm, 10 "
<b>16-036-03</b>	25,5 cm, 10 "



100 x 45 mm  
**16-037-28**

### KUEMMEL

**16-037-28** 31,0 cm, 12 ¼"



<b>16-037-40</b>	70 x 40 mm
<b>16-037-50</b>	70 x 50 mm
<b>16-037-65</b>	70 x 65 mm

### MORRIS

**16-037-40 - 16-037-65** 24,0 cm, 9 ½"



53 x 80 mm  
**16-038-25**

**DOYEN**

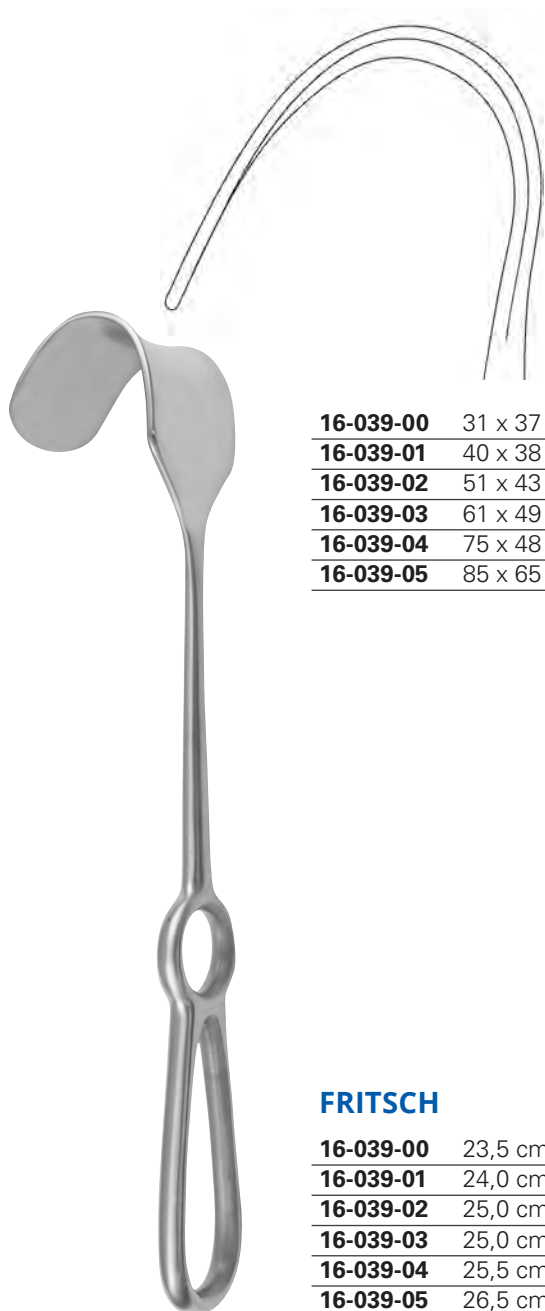
**16-038-25** 25,0 cm, 10 "



78 x 82 mm  
**16-038-26**

**DOYEN**

**16-038-26** 26,0 cm, 10 ¼ "



<b>16-039-00</b>	31 x 37 mm
<b>16-039-01</b>	40 x 38 mm
<b>16-039-02</b>	51 x 43 mm
<b>16-039-03</b>	61 x 49 mm
<b>16-039-04</b>	75 x 48 mm
<b>16-039-05</b>	85 x 65 mm

### FRITSCH

<b>16-039-00</b>	23,5 cm, 9 ¼"
<b>16-039-01</b>	24,0 cm, 9 ½"
<b>16-039-02</b>	25,0 cm, 9 ¾"
<b>16-039-03</b>	25,0 cm, 9 ¾"
<b>16-039-04</b>	25,5 cm, 10"
<b>16-039-05</b>	26,5 cm, 10 ½"



58 x 64 mm  
**16-040-00**

### TUFFIER

<b>16-040-00</b>	21,5 cm, 8 ½"
------------------	---------------



70 x 25 mm  
**16-041-00**

**KOCHER**

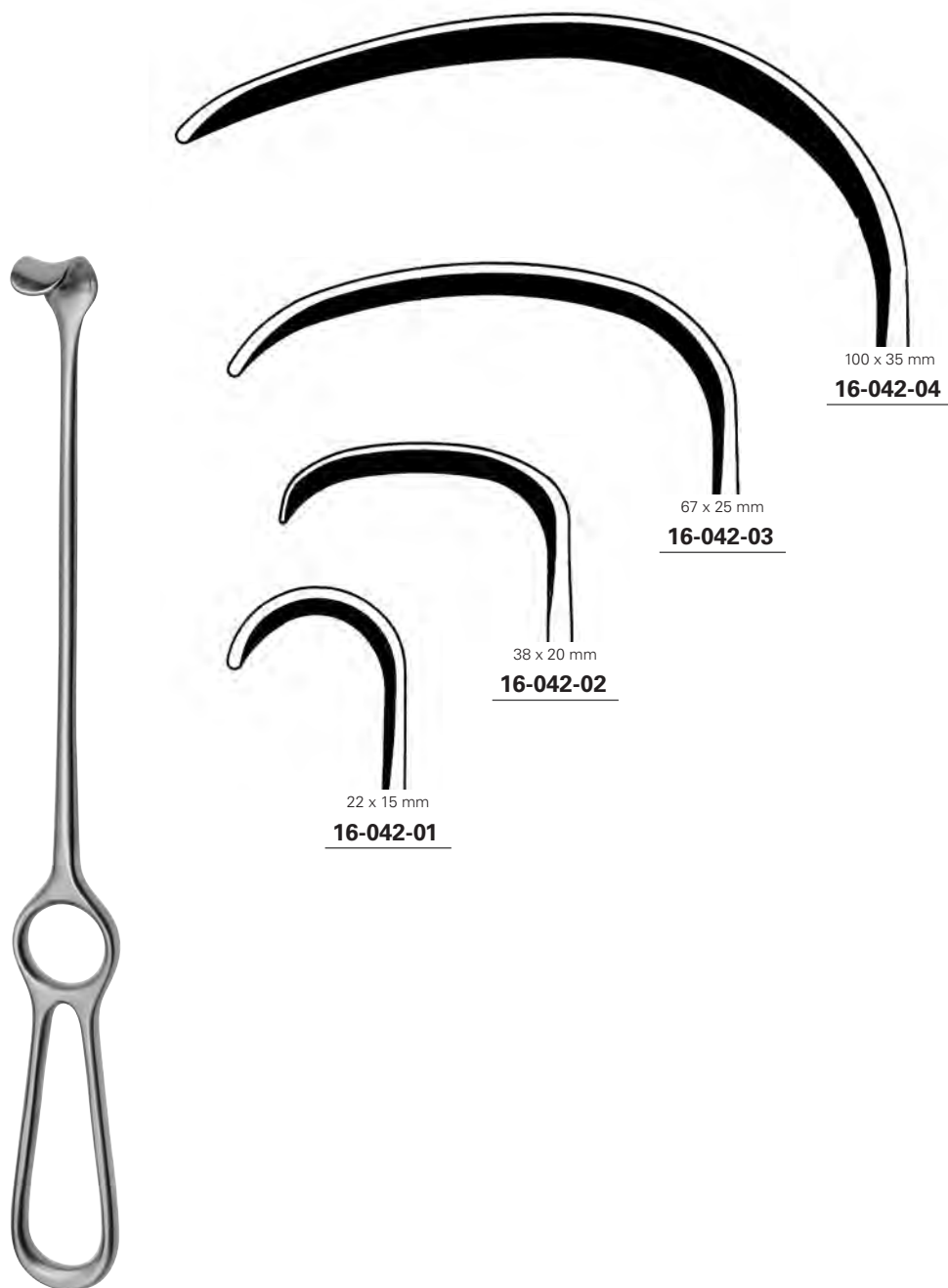
**16-041-00** 24,0 cm, 9 ½"



<b>16-041-01</b>	80 x 45 mm
<b>16-041-02</b>	80 x 55 mm
<b>16-041-03</b>	80 x 65 mm

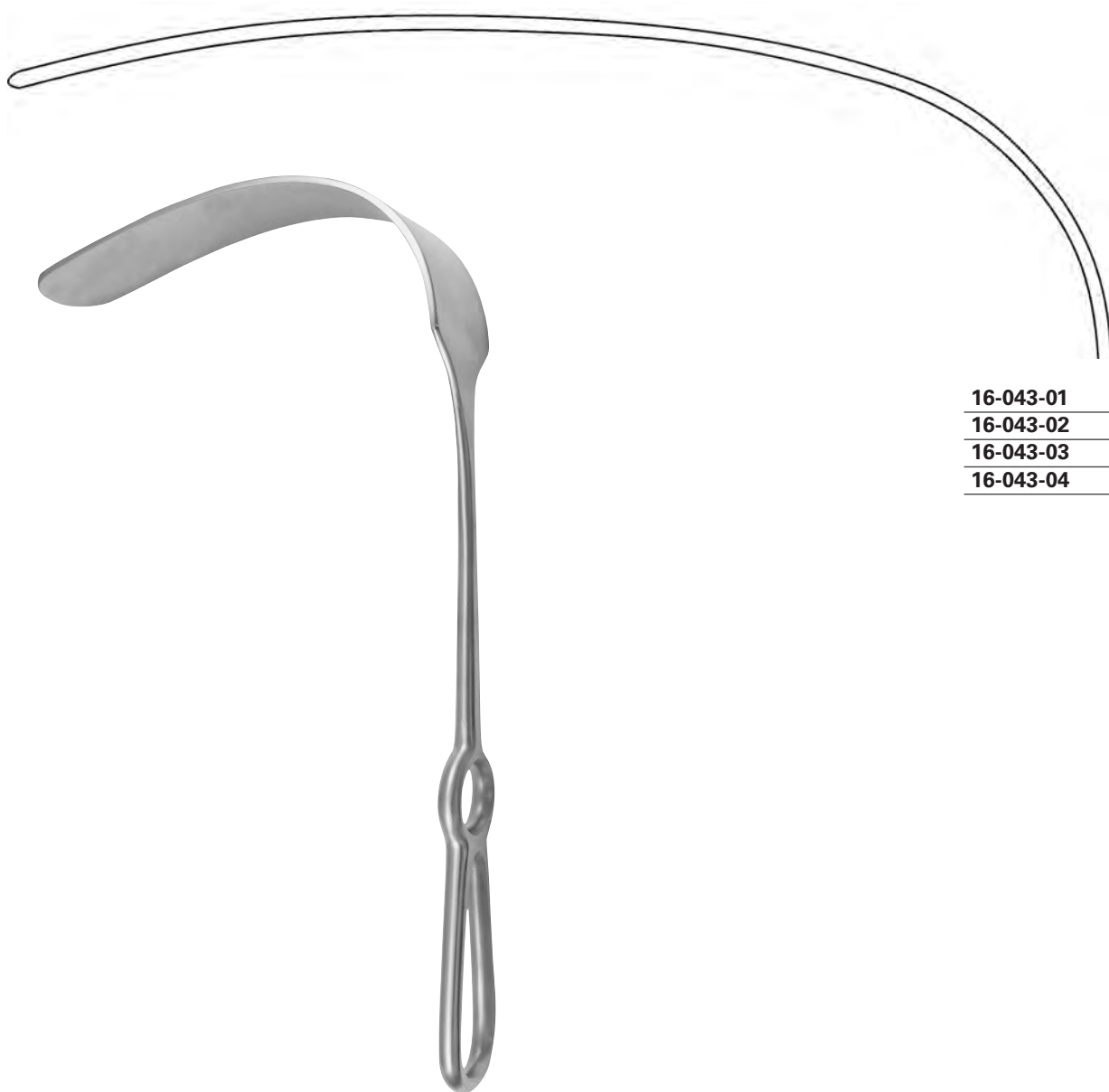
**KOCHER**

**16-041-01 - 16-041-03** 25,0 cm, 9 ¾"



## KOCHER-WAGNER

16-042-01 - 16-042-04 28,0 cm, 11 ¼"

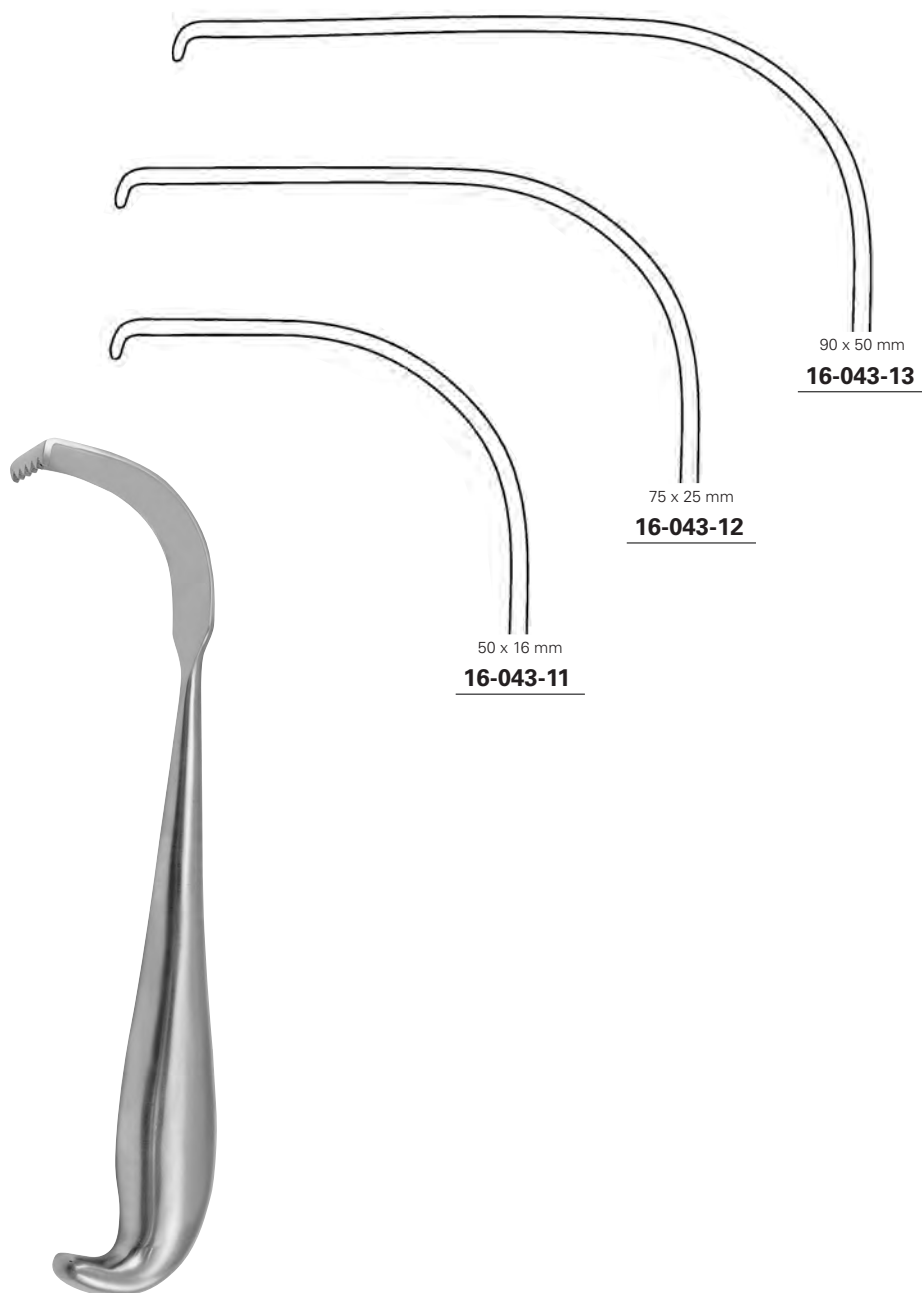


<b>16-043-01</b>	190 x 38 mm
<b>16-043-02</b>	190 x 57 mm
<b>16-043-03</b>	150 x 38 mm
<b>16-043-04</b>	150 x 57 mm

**KELLY**

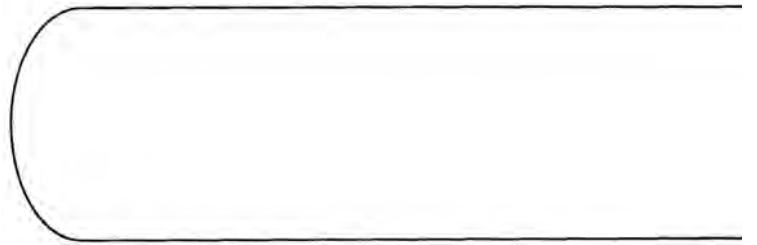
**16-043-01 - 16-043-04** 27,0 cm, 10 ½"





## MEYERDING

**16-043-11 - 16-043-13** 23,0 cm, 9"



<b>16-045-01</b>	60 x 20 mm
<b>16-045-02</b>	80 x 30 mm
<b>16-045-03</b>	100 x 30 mm
<b>16-045-04</b>	120 x 30 mm
<b>16-045-05</b>	140 x 30 mm
<b>16-045-06</b>	140 x 40 mm
<b>16-045-07</b>	220 x 40 mm



<b>16-044-01</b>	97 x 29 mm
<b>16-044-02</b>	101 x 31 mm
<b>16-044-03</b>	127 x 52 mm

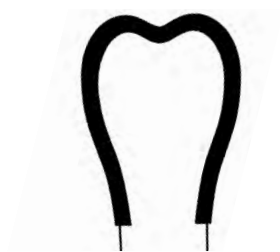


**DOYEN-STILLE**

**16-044-01 - 16-044-03** 26,0 cm, 10 ¼"

**HOESEL**

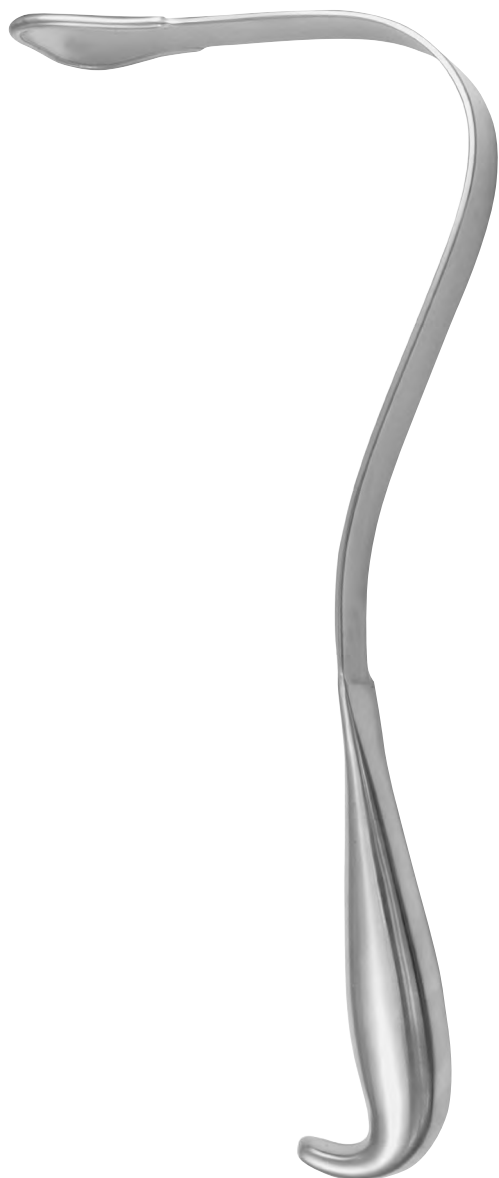
**16-045-01 - 16-045-07** 26,0 cm, 10 ¼"



**16-046-01** 127 x 40 mm  
**16-046-02** 127 x 62 mm



175 x 64 mm  
**16-046-03**



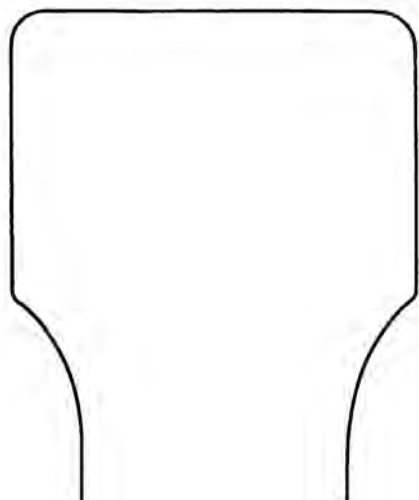
## HARRINGTON

**16-046-01 - 16-046-02** 31,0 cm, 12 1/4"

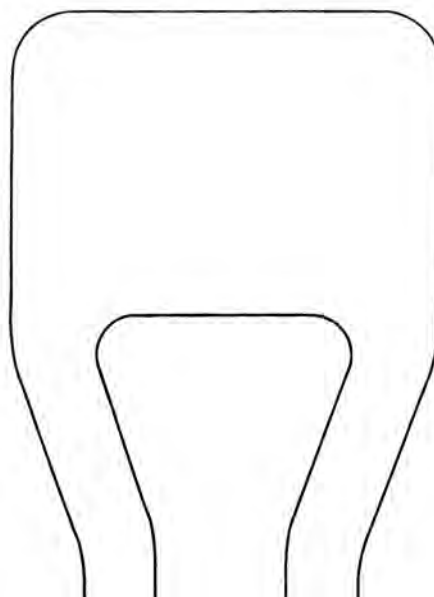


## HARRINGTON-PEMBERTON

**16-046-03** 29,5 cm, 11 3/4"



**16-046-05**



**16-046-06**



**POLLOSON**

**16-046-05** 29,0 cm, 11 ½"



**POLLOSON**

**16-046-06** 26,0 cm, 10 ¼"



## RICHARDSON-EASTMAN

**16-047-00** SET



Fig. 1  
**16-047-01**  
28 x 20 mm

Fig. 2  
**16-047-02**  
49 x 38 mm

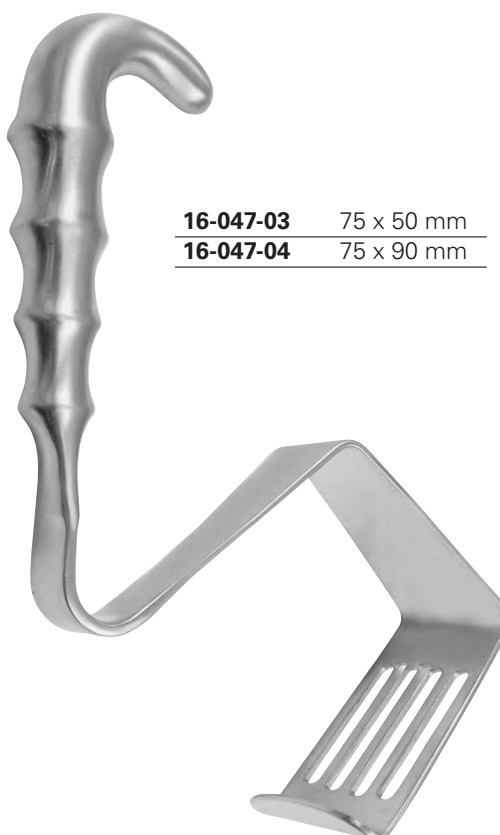
Fig. 1  
**16-047-01**  
36 x 28 mm

Fig. 2  
**16-047-02**  
63 x 49 mm

## RICHARDSON-EASTMAN

**16-047-01** 26,0 cm, 10 1/4"

**16-047-02** 27,0 cm, 10 3/4"

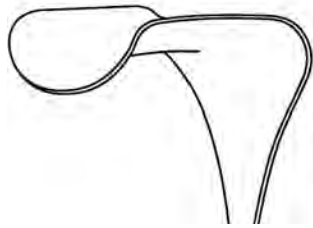


**16-047-03** 75 x 50 mm  
**16-047-04** 75 x 90 mm

## DAVIDSON

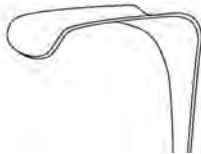
**16-047-03** 19,0 cm, 7 1/2"

**16-047-04** 18,5 cm, 7 1/4"



65 x 50 mm

**16-047-15**



52 x 22 mm

**16-047-14**



44 x 38 mm

**16-047-13**



36 x 28 mm

**16-047-12**



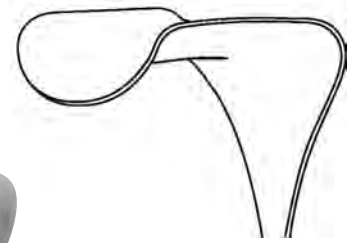
28 x 20 mm

**16-047-11**



**RICHARDSON**

**16-047-11 - 16-047-15** 24,0 cm, 9 1/2"



51 x 64 mm

**16-047-20**



**KELLY**

**16-047-20** 26,0 cm, 10 1/4"



90 x 75 mm  
**16-047-24**



75 x 65 mm  
**16-047-23**



65 x 50 mm  
**16-047-22**



50 x 40 mm  
**16-047-21**

## KELLY

**16-047-21 - 16-047-24** 26,0 cm, 10 1/4"



95 x 20 mm

**16-048-01**

**MOD. TUEBINGEN**

**16-048-01** 26,0 cm, 10 1/4"



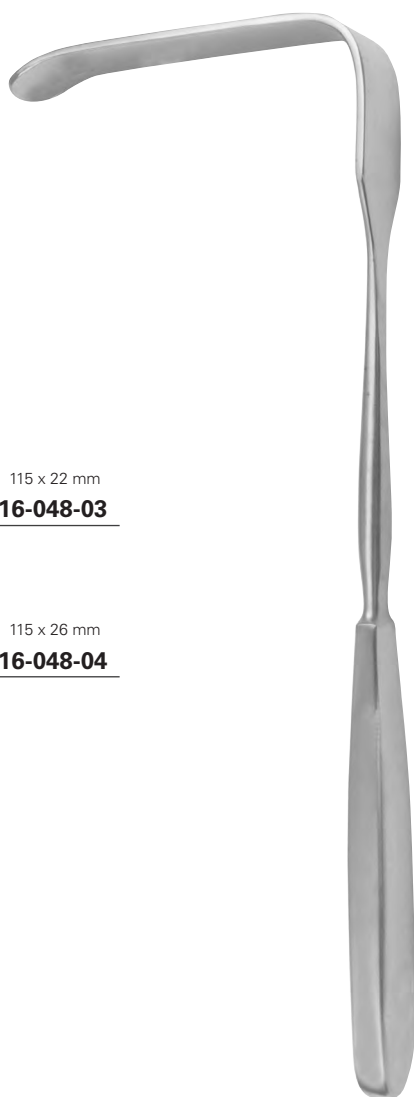
105 x 27 mm

**16-048-02**

**MARTIN**

**16-048-02** 25,0 cm, 10"





115 x 22 mm

**16-048-03**

115 x 26 mm

**16-048-04**

**SIMON**

**16-048-03 - 16-048-04** 28,0 cm, 11 "



145 x 25 mm

**16-048-05**

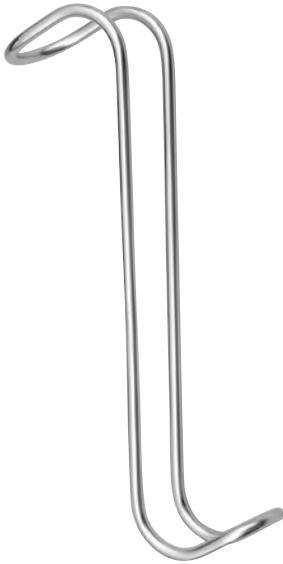
145 x 25 mm

**16-048-55**

mit Kaltlicht  
with cold light  
con luz fría  
con fibra ottica

**BRUNNER**

**16-048-05 - 16-048-55** 24,0 cm, 9 ½ "



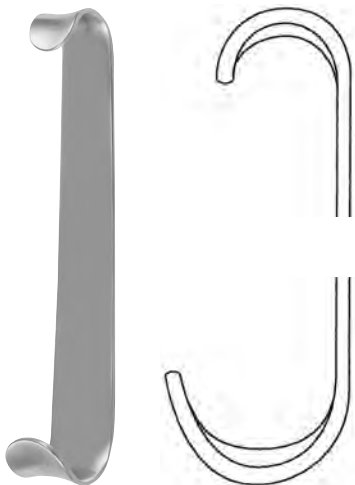
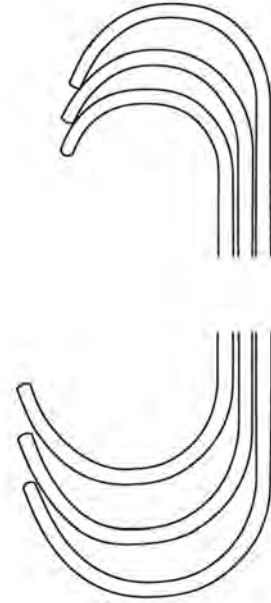
**COLLIN-HARTMANN**

<b>16-049-01</b>	14,0 cm, 5 1/2"
<b>16-049-02</b>	16,0 cm, 6 1/4"



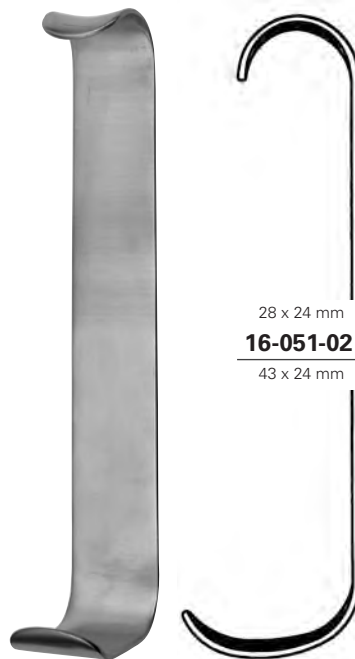
**ROUX**

<b>16-050-00</b>	SET Fig. 1 - 3
<b>16-050-01</b>	14,0 cm, 5 1/2"
<b>16-050-02</b>	15,0 cm, 6"
<b>16-050-03</b>	17,0 cm, 6 3/4"



**BABY-ROUX**

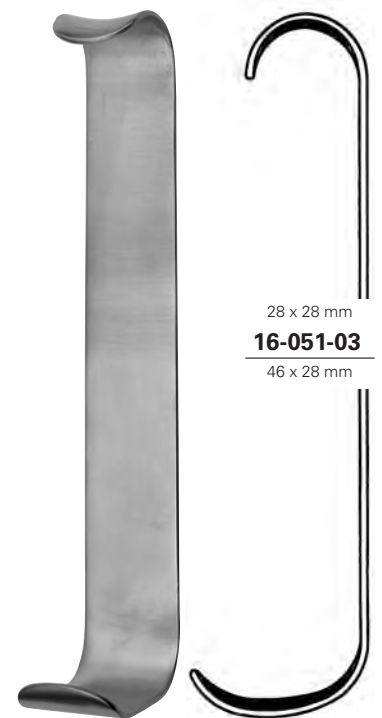
<b>16-051-01</b>	12,5 cm, 5"
------------------	-------------



**ROUX**

<b>16-051-02</b>	17,0 cm, 6 3/4"
------------------	-----------------

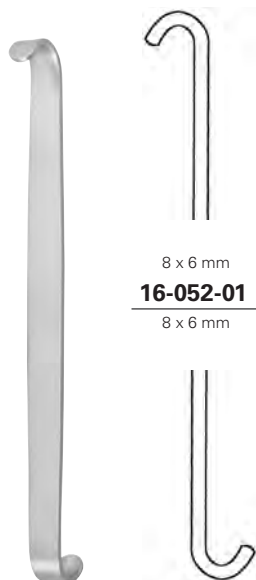
28 x 24 mm  
**16-051-02**  
43 x 24 mm



**ROUX**

<b>16-051-03</b>	19,0 cm, 7 1/2"
------------------	-----------------

28 x 28 mm  
**16-051-03**  
46 x 28 mm



8 x 6 mm  
**16-052-01**  
8 x 6 mm

### MINI-ROUX

**16-052-01** 14,5 cm, 5 3/4"



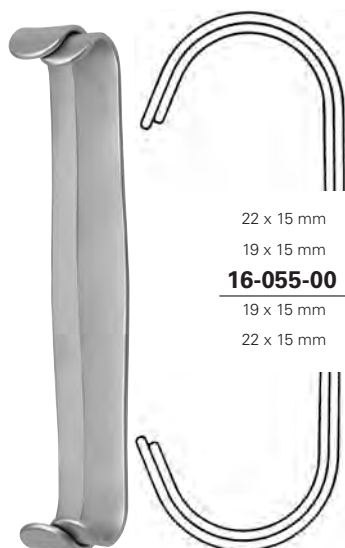
### ROUX-MAGNUS

**16-053-00** SET Fig. 1 - 3  
**16-053-01** 14,0 cm, 5 1/2"  
**16-053-02** 15,0 cm, 6"  
**16-053-03** 17,0 cm, 6 3/4"



### PARKER

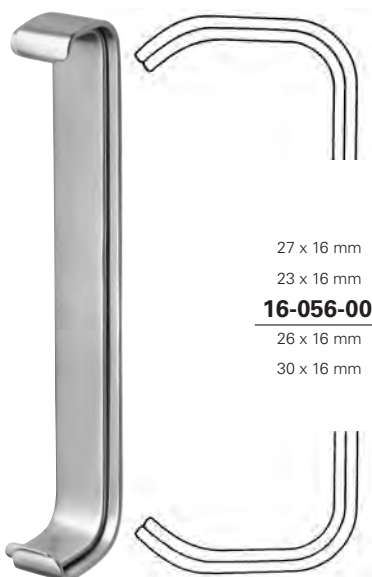
**16-054-00** 17,5 cm, 7"



22 x 15 mm  
19 x 15 mm  
**16-055-00**  
19 x 15 mm  
22 x 15 mm

### PARKER-BABY

**16-055-00** 13,5 cm, 5 1/4"



27 x 16 mm  
23 x 16 mm  
**16-056-00**  
26 x 16 mm  
30 x 16 mm

### FARABEU F

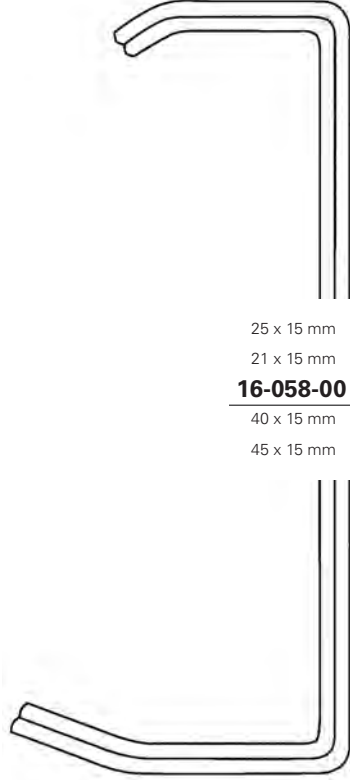
**16-056-00** 15,0 cm, 6"



30 x 10 mm  
26 x 10 mm  
**16-057-00**  
30 x 13 mm  
34 x 13 mm

### FARABEU S

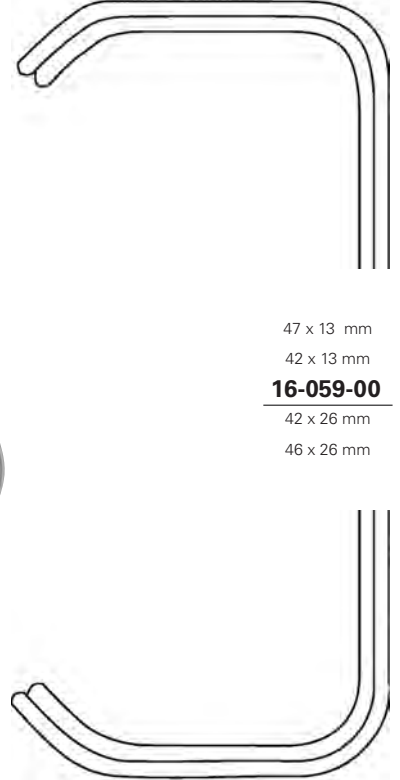
**16-057-00** 11,5 cm, 4 1/2"



25 x 15 mm  
21 x 15 mm  
**16-058-00**  
40 x 15 mm  
45 x 15 mm

**PARKER-LANGENBECK**

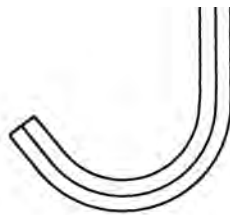
**16-058-00** 21,0 cm, 8 ½"



47 x 13 mm  
42 x 13 mm  
**16-059-00**  
42 x 26 mm  
46 x 26 mm

**MATHIEU**

**16-059-00** 20,0 cm, 8"



68 x 24 mm  
72 x 24 mm  
**16-060-00**  
25 x 24 mm  
21 x 24 mm

**PARKER-MOTT**

**16-060-00** 16,0 cm, 6 ½"



40 x 40 mm  
**16-061-19**  
30 x 30 mm

**GOELET**

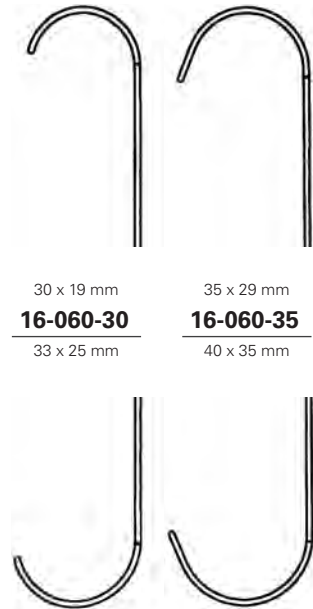
**16-061-19** 19,0 cm, 7 ½"



16 x 3 mm  
**16-060-15**  
6 x 3 mm

### RAGNELL

**16-060-15** 15,0 cm, 6"

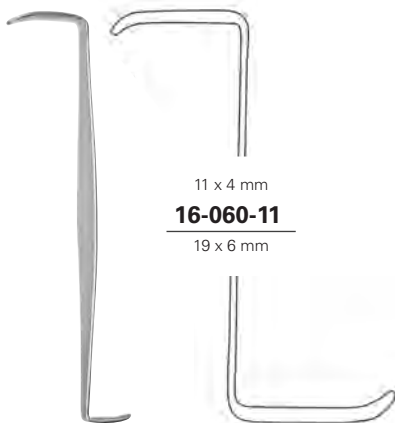


30 x 19 mm  
**16-060-30**  
33 x 25 mm

35 x 29 mm  
**16-060-35**  
40 x 35 mm

### KILNER

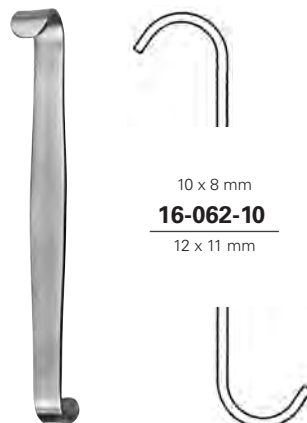
**16-060-30 - 16-060-35** 15,0 cm, 6"



11 x 4 mm  
**16-060-11**  
19 x 6 mm

### CRILE

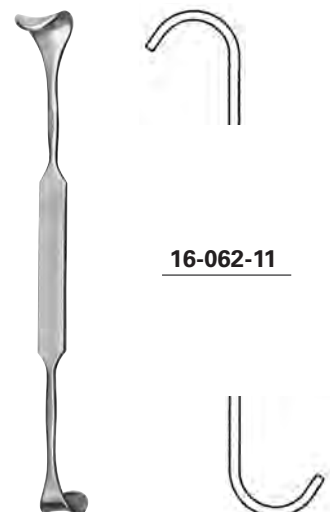
**16-060-11** 11,0 cm, 4 3/8"



10 x 8 mm  
**16-062-10**  
12 x 11 mm

### LUER

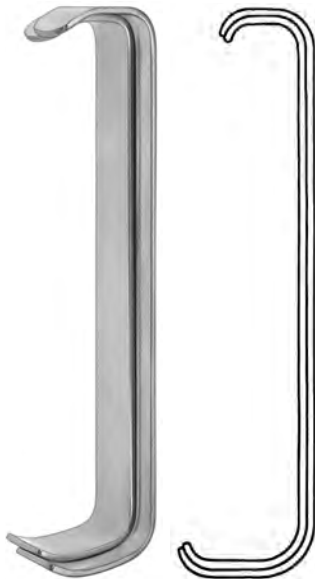
**16-062-10** 11,0 cm, 4 3/8"



**16-062-11**

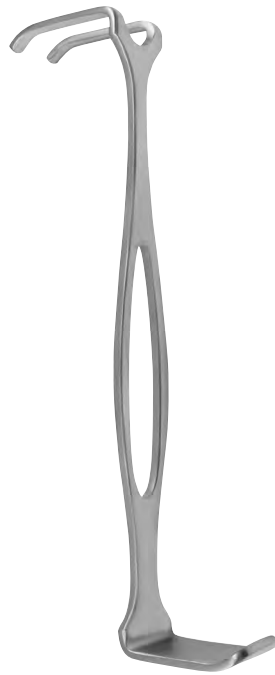
### ROSE

**16-062-11** 13,5 cm, 5 1/4"



**COLLIN**

**16-063-00** 15,0 cm, 6"



**CZERNY**

**16-063-18** 17,5 cm, 7"



**WILLIGER**

**16-064-01 - 16-064-03** 12,0 cm, 4 3/4"



**16-064-01**



**16-064-02**



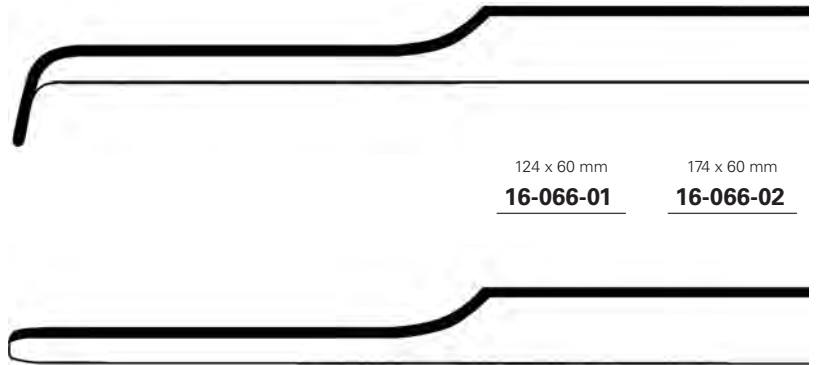
**16-064-03**



**ST. MARKS**

**16-066-01** 29,0 cm, 11 1/2"

**16-066-02 - 16-066-03** 33,0 cm, 13"



124 x 60 mm

**16-066-01**

174 x 60 mm

**16-066-02**

178 x 60 mm

**16-066-03**



## REVERDIN

**16-071-28** 28,0 cm, 11 "



biegsam  
malleable  
maleable  
malleabile

<b>16-072-01</b>	330 x 20 mm
<b>16-072-02</b>	330 x 25 mm
<b>16-072-03</b>	330 x 30 mm
<b>16-072-04</b>	330 x 40 mm
<b>16-072-05</b>	330 x 50 mm



biegsam  
malleable  
maleable  
malleabile

## HABERER

<b>16-073-01</b>	200 x 17 25 mm
<b>16-073-02</b>	280 x 25 30 mm
<b>16-073-03</b>	300 x 47 45 mm
<b>16-073-04</b>	300 x 40 50 mm



biegsam  
malleable  
maleable  
malleabile

<b>16-074-01</b>	200 x 6 mm
<b>16-074-02</b>	200 x 8 mm
<b>16-074-03</b>	200 x 10 mm
<b>16-074-04</b>	200 x 12 mm
<b>16-074-05</b>	200 x 17 mm
<b>16-074-06</b>	200 x 25 mm
<b>16-074-07</b>	250 x 25 mm

mit Kaltlicht und Absaugung  
with cold light and suction  
con luz fría y aspiración  
con fibra ottica e aspirazione



<b>16-067-00</b>	80 x 16 mm
<b>16-067-01</b>	90 x 24 mm
<b>16-067-02</b>	90 x 30 mm
<b>16-067-03</b>	100 x 24 mm
<b>16-067-04</b>	120 x 25 mm
<b>16-067-05</b>	120 x 30 mm
<b>16-067-06</b>	150 x 25 mm
<b>16-067-07</b>	150 x 30 mm
<b>16-067-08</b>	150 x 36 mm
<b>16-067-09</b>	170 x 40 mm
<b>16-067-10</b>	190 x 30 mm

mit Kaltlicht und Absaugung  
with cold light and suction  
con luz fría y aspiración  
con fibra ottica e aspirazione



<b>16-068-00</b>	80 x 16 mm
<b>16-068-01</b>	90 x 24 mm
<b>16-068-02</b>	90 x 30 mm
<b>16-068-03</b>	100 x 24 mm
<b>16-068-04</b>	120 x 25 mm
<b>16-068-05</b>	120 x 30 mm
<b>16-068-06</b>	150 x 25 mm
<b>16-068-07</b>	150 x 30 mm
<b>16-068-08</b>	150 x 36 mm
<b>16-068-09</b>	170 x 40 mm
<b>16-068-10</b>	190 x 30 mm

mit Kaltlicht und Absaugung  
with cold light and suction  
con luz fría y aspiración  
con fibra ottica e aspirazione



<b>16-069-00</b>	80 x 16 mm
<b>16-069-01</b>	100 x 24 mm
<b>16-069-02</b>	120 x 25 mm
<b>16-069-03</b>	120 x 30 mm
<b>16-069-04</b>	150 x 25 mm
<b>16-069-05</b>	150 x 30 mm
<b>16-069-06</b>	170 x 40 mm
<b>16-069-07</b>	180 x 25 mm

ohne Kaltlicht und Absaugung  
without cold light and suction  
sin luz fría y aspiración  
senza fibra ottica e aspirazione



<b>16-067-60</b>	80 x 16 mm
<b>16-067-61</b>	90 x 24 mm
<b>16-067-62</b>	90 x 30 mm
<b>16-067-63</b>	100 x 24 mm
<b>16-067-64</b>	120 x 25 mm
<b>16-067-65</b>	120 x 30 mm
<b>16-067-66</b>	150 x 25 mm
<b>16-067-67</b>	150 x 30 mm
<b>16-067-68</b>	150 x 36 mm
<b>16-067-69</b>	170 x 40 mm
<b>16-067-70</b>	190 x 30 mm

ohne Kaltlicht und Absaugung  
without cold light and suction  
sin luz fría y aspiración  
senza fibra ottica e aspirazione

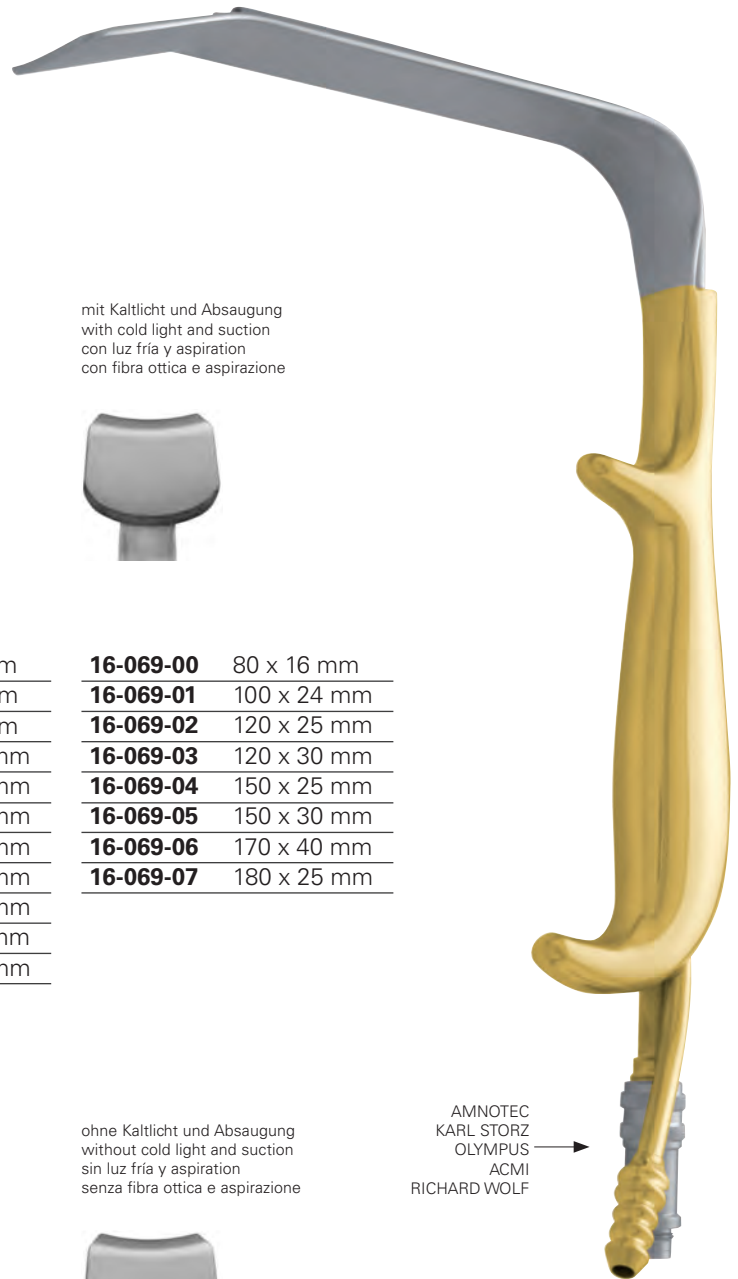


<b>16-068-60</b>	80 x 16 mm
<b>16-068-61</b>	90 x 24 mm
<b>16-068-62</b>	90 x 30 mm
<b>16-068-63</b>	100 x 24 mm
<b>16-068-64</b>	120 x 25 mm
<b>16-068-65</b>	120 x 30 mm
<b>16-068-66</b>	150 x 25 mm
<b>16-068-67</b>	150 x 30 mm
<b>16-068-68</b>	150 x 36 mm
<b>16-068-69</b>	170 x 40 mm
<b>16-068-70</b>	190 x 30 mm

ohne Kaltlicht und Absaugung  
without cold light and suction  
sin luz fría y aspiración  
senza fibra ottica e aspirazione



<b>16-069-60</b>	80 x 16 mm
<b>16-069-61</b>	100 x 24 mm
<b>16-069-62</b>	120 x 25 mm
<b>16-069-63</b>	120 x 30 mm
<b>16-069-64</b>	150 x 25 mm
<b>16-069-65</b>	150 x 30 mm
<b>16-069-66</b>	170 x 40 mm
<b>16-069-67</b>	180 x 25 mm



AMNOTEC  
KARL STORZ  
OLYMPUS  
ACMI  
RICHARD WOLF





46 mm  
**16-076-45**

**LERICHE**

**16-076-45** 25,5 cm, 10"



60 mm  
**16-076-60**

**LERICHE**

**16-076-60** 27,5 cm, 10<sup>3</sup>/<sub>4</sub>"



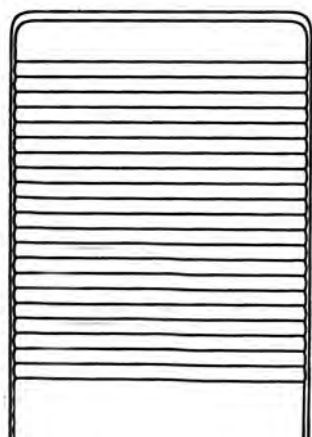
**KUEMMEL**

**16-077-46** 28,5 cm, 11 ¼"



**KOERTE**

**16-078-46** 30,0 cm, 11 ¾"



40 mm

**16-079-40**



30 mm

**16-079-30**



20 mm

**16-079-20**



<b>16-080-30</b>	30 mm
<b>16-080-40</b>	40 mm
<b>16-080-50</b>	50 mm
<b>16-080-60</b>	60 mm
<b>16-080-70</b>	70 mm

biegsam  
 malleable  
 malleable  
 malleabile

## KADER

**16-079-20 - 16-079-40** 28,0 cm, 11"

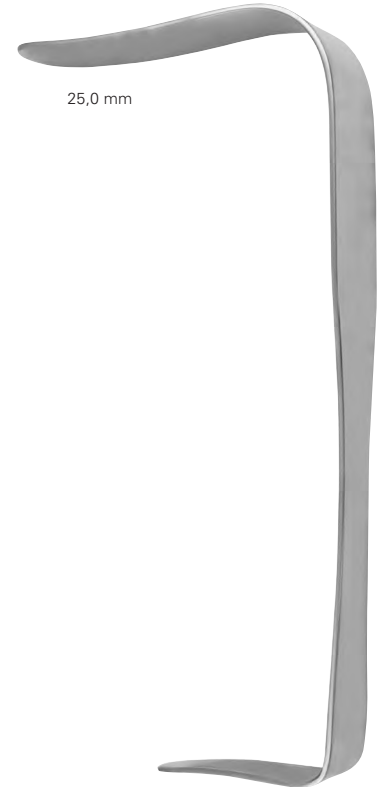
**16-080-30 - 16-080-70** 41,0 cm, 16"



**DEAVER** **Fig. 1**  
**16-081-01** 18,0 cm, 7 "



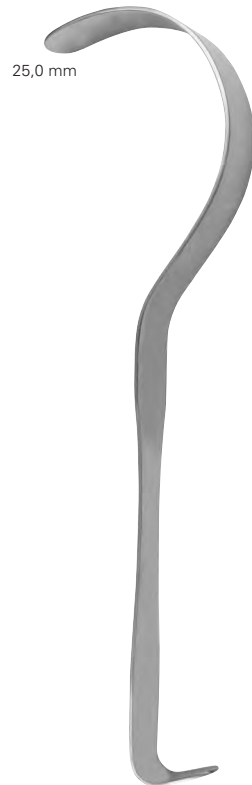
**DEAVER** **Fig. 2**  
**16-081-02** 21,5 cm, 8 ½ "



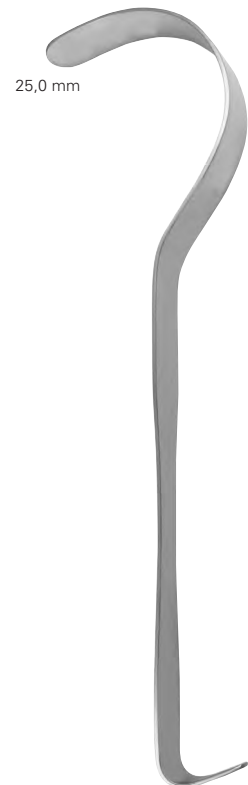
**DEAVER** **Fig. 3**  
**16-081-03** 25,0 cm, 9 ¾ "



**DEAVER** **Fig. 4**  
**16-081-04** 30,0 cm, 11 ¾ "



**DEAVER** **Fig. 5**  
**16-081-05** 33,0 cm, 13 "



**DEAVER** **Fig. 6**  
**16-081-06** 36,0 cm, 14 ¼ "



38,0 mm

**DEAVER** **Fig. 7**  
**16-081-07** 30,0 cm, 11 <sup>3</sup>/<sub>4</sub>"



50,0 mm

**DEAVER** **Fig. 8**  
**16-081-08** 31,0 cm, 12 <sup>1</sup>/<sub>4</sub>"



75,0 mm

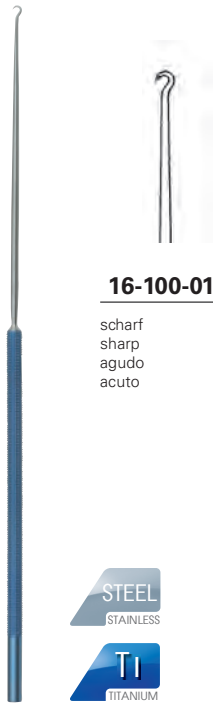
**DEAVER** **Fig. 9**  
**16-081-09** 32,0 cm, 12 <sup>1</sup>/<sub>2</sub>"



- 16-082-01** Fig. 1 | 25 mm
- 16-082-02** Fig. 2 | 38 mm
- 16-082-03** Fig. 3 | 50 mm
- 16-082-04** Fig. 4 | 75 mm
- 16-082-05** Fig. 5 | 100 mm

**DEAVER**

**16-082-01 - 16-082-05** 31,0 cm, 12 <sup>1</sup>/<sub>4</sub>"



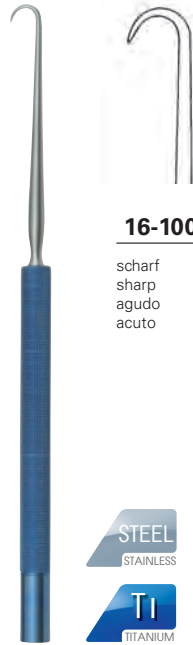
**16-100-01**

scharf  
sharp  
agudo  
acuto



**VICKERS**

**16-100-01** 18,5 cm, 7 ¼"



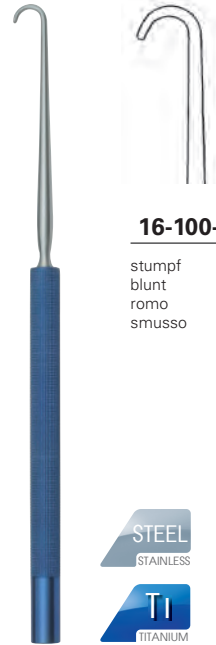
**16-100-02**

scharf  
sharp  
agudo  
acuto



**VICKERS**

**16-100-02** 17,0 cm, 6 ¾"



**16-100-03**

stumpf  
blunt  
romo  
smusso



**VICKERS**

**16-100-03** 17,0 cm, 6 ¾"



**16-100-04**

scharf  
sharp  
agudo  
acuto



**VICKERS**

**16-100-04** 16,0 cm, 6 ¾"



**16-100-05**

scharf  
sharp  
agudo  
acuto

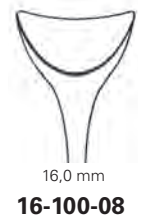


**VICKERS**

**16-100-05** 16,0 cm, 6 ¾"

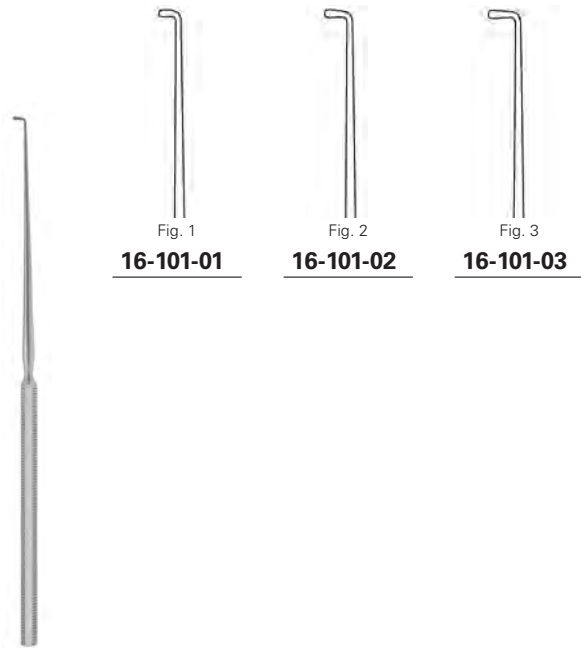


12,0 mm  
**16-100-06**



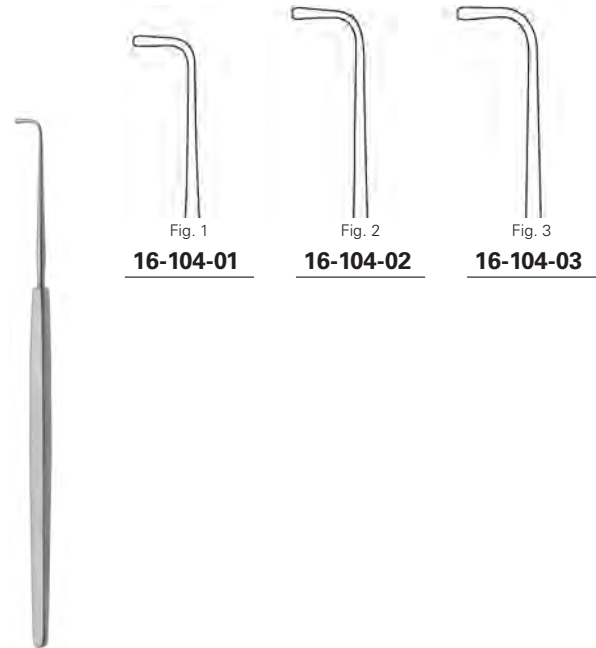
**VICKERS**

**16-100-06 - 16-100-08** 14,0 cm, 5 ½"



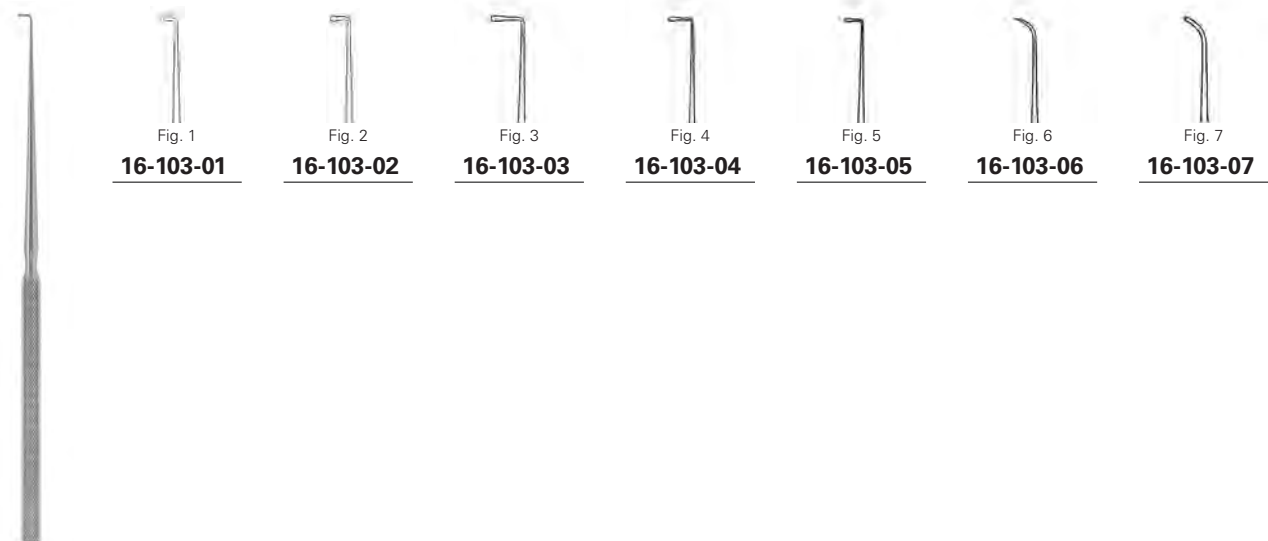
**LUCAE**

**16-101-01 - 16-101-03** 14,0 cm, 5 ½"



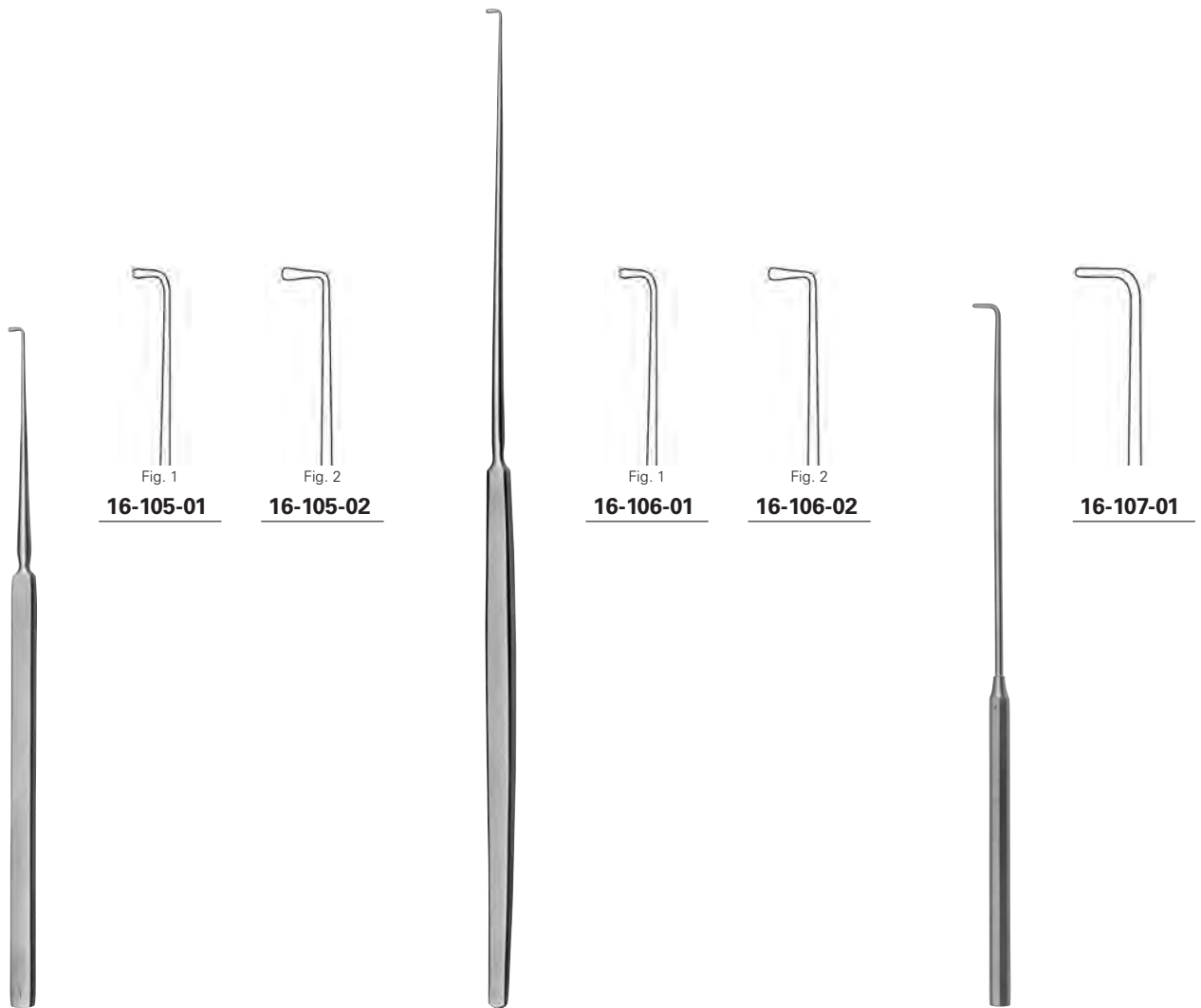
**GRAEFE**

**16-104-01** 13,0 cm, 5 ⅛"  
**16-104-02 - 16-104-03** 14,0 cm, 5 ½"



**WAGENER**

**16-103-01 - 16-103-07** 14,0 cm, 5 ½"



**CUSHING**

**16-105-01 - 16-105-02** 19,0 cm, 7 1/2"

**CUSHING**

**16-106-01 - 16-106-02** 28,0 cm, 11"

**CRILE**

**16-107-01** 20,0 cm, 8"





**16-107-17**

**BROM**

**16-107-17** 17,0 cm, 6 3/4"



**16-108-01**

scharf  
 sharp  
 agudo  
 acuto



**16-109-01**

stumpf  
 blunt  
 romo  
 smusso



**GRAEFE**

**16-108-01 - 16-109-01** 15,0 cm, 6"



Fig. 1

**16-110-01**

scharf  
 sharp  
 agudo  
 acuto



Fig. 2

**16-110-02**

scharf  
 sharp  
 agudo  
 acuto



Fig. 3

**16-110-03**

scharf  
 sharp  
 agudo  
 acuto



Fig. 4

**16-110-04**

scharf  
 sharp  
 agudo  
 acuto



**16-111-01**

scharf  
 sharp  
 agudo  
 acuto



90°

**16-111-02**

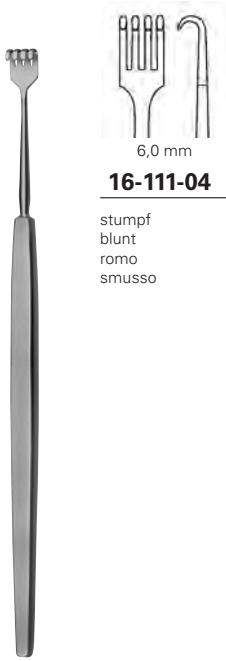
scharf  
 sharp  
 agudo  
 acuto



**O'CONNOR**

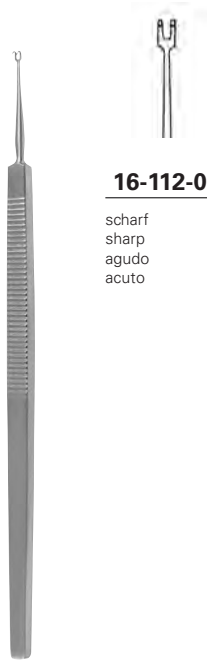
**16-111-01 - 16-111-02** 16,0 cm, 6 1/4"

**16-110-01 - 16-110-04** 16,0 cm, 6 1/4"



6,0 mm  
**16-111-04**

stumpf  
blunt  
romo  
smusso



**16-112-01**

scharf  
sharp  
agudo  
acuto



**16-112-02**

scharf  
sharp  
agudo  
acuto



**16-112-03**

scharf  
sharp  
agudo  
acuto



**16-112-04**

scharf  
sharp  
agudo  
acuto

**KNAPP**

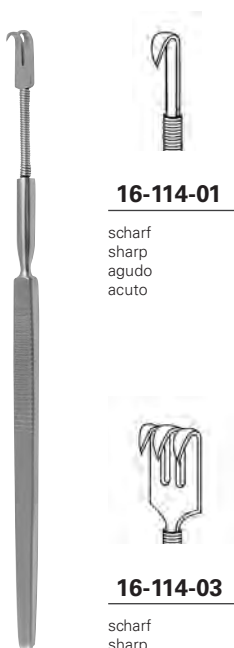
**16-111-04** 16,0 cm, 6 ¼"

**GUTHRIE**

**16-112-01 - 16-112-02** 16,0 cm, 6 ¼"

**ROLLET**

**16-112-03 - 16-112-04** 13,0 cm, 5 ⅛"



**16-114-01**

scharf  
sharp  
agudo  
acuto



**16-114-02**

scharf  
sharp  
agudo  
acuto



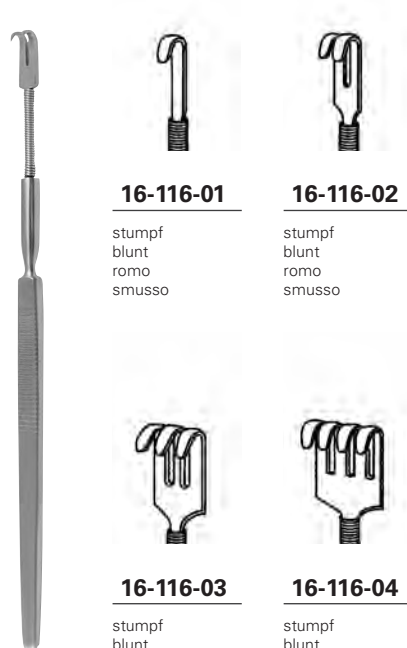
**16-114-03**

scharf  
sharp  
agudo  
acuto



**16-114-04**

scharf  
sharp  
agudo  
acuto



**16-116-01**

stumpf  
blunt  
romo  
smusso



**16-116-02**

stumpf  
blunt  
romo  
smusso



**16-116-03**

stumpf  
blunt  
romo  
smusso



**16-116-04**

stumpf  
blunt  
romo  
smusso

**16-114-01 - 16-114-04** 16,0 cm, 6 ¼"

**16-116-01 - 16-116-04** 16,0 cm, 6 ¼"



**16-117-04**

scharf  
 sharp  
 agudo  
 acuto



**16-118-04**

stumpf  
 blunt  
 romo  
 smusso



14,0 x 8,0 mm

**16-119-01**

**16-117-04 - 16-118-04** 16,0 cm, 6 ¼ "

**16-119-01** 16,0 cm, 6 ¼ "



12,0 x 6,0 mm

**16-119-02**



12,0 x 11,0 mm

**16-119-03**



15,0 x 11,0 mm

**16-119-04**



**16-119-13**



**KLAPP**

**16-119-02 - 16-119-04** 17,5 cm, 7 "

**MOLDESTAD**

**16-119-13** 13,0 cm, 5 ⅛ "



**16-120-01**

scharf  
sharp  
agudo  
acuto



**16-120-02**

scharf  
sharp  
agudo  
acuto



**16-120-03**

scharf  
sharp  
agudo  
acuto



**16-120-04**

scharf  
sharp  
agudo  
acuto



**16-122-01**

stumpf  
blunt  
romo  
smusso



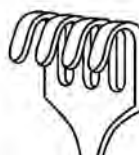
**16-122-02**

stumpf  
blunt  
romo  
smusso



**16-122-03**

stumpf  
blunt  
romo  
smusso



**16-122-04**

stumpf  
blunt  
romo  
smusso

**16-120-01 - 16-122-04** 16,0 cm, 6 ¼"



7,0 mm

**16-121-07**



9,0 mm

**16-121-09**



7,0 mm

**16-123-14**

stumpf  
blunt  
romo  
smusso



**BERGMANN**

**16-123-14** 14,0 cm, 5 ½"

**16-121-07 - 16-121-09** 16,0 cm, 6 ¼"



**16-124-01**

scharf  
sharp  
agudo  
acuto



**16-125-01**

halbscharf  
semi-sharp  
semi-agudo  
semi-acuto



**16-126-01**

stumpf  
blunt  
romo  
smusso



**16-124-11**

scharf  
sharp  
agudo  
acuto



**16-125-11**

stumpf  
blunt  
romo  
smusso



**16-124-02**

scharf  
sharp  
agudo  
acuto



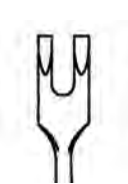
**16-125-02**

halbscharf  
semi-sharp  
semi-agudo  
semi-acuto



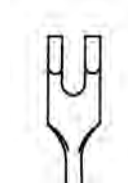
**16-126-02**

stumpf  
blunt  
romo  
smusso



**16-124-12**

scharf  
sharp  
agudo  
acuto



**16-125-12**

stumpf  
blunt  
romo  
smusso



**16-124-03**

scharf  
sharp  
agudo  
acuto



**16-125-03**

halbscharf  
semi-sharp  
semi-agudo  
semi-acuto



**16-126-03**

stumpf  
blunt  
romo  
smusso



**16-124-13**

scharf  
sharp  
agudo  
acuto



**16-125-13**

stumpf  
blunt  
romo  
smusso



**16-124-04**

scharf  
sharp  
agudo  
acuto



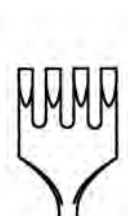
**16-125-04**

halbscharf  
semi-sharp  
semi-agudo  
semi-acuto



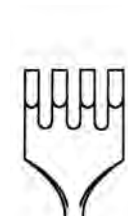
**16-126-04**

stumpf  
blunt  
romo  
smusso



**16-124-14**

scharf  
sharp  
agudo  
acuto



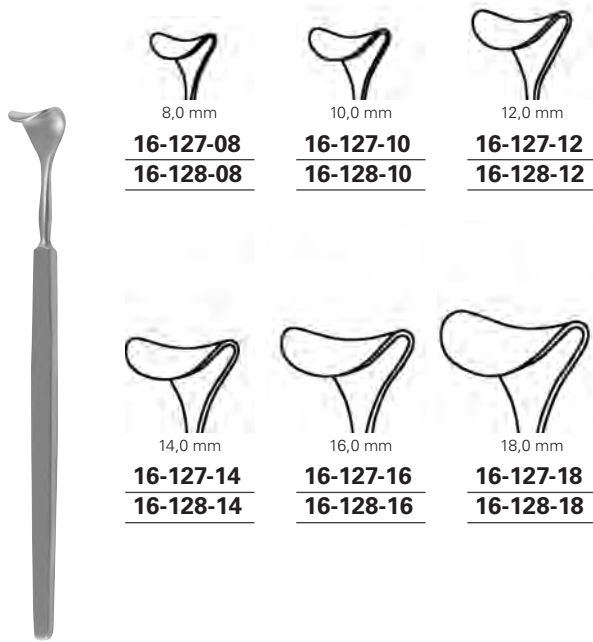
**16-125-14**

stumpf  
blunt  
romo  
smusso



**16-124-01 - 16-126-04** 16,5 cm, 6 ½ "

**16-124-11 - 16-125-14** 16,5 cm, 6 ½ "



8,0 mm  
**16-127-08**  
**16-128-08**

10,0 mm  
**16-127-10**  
**16-128-10**

12,0 mm  
**16-127-12**  
**16-128-12**

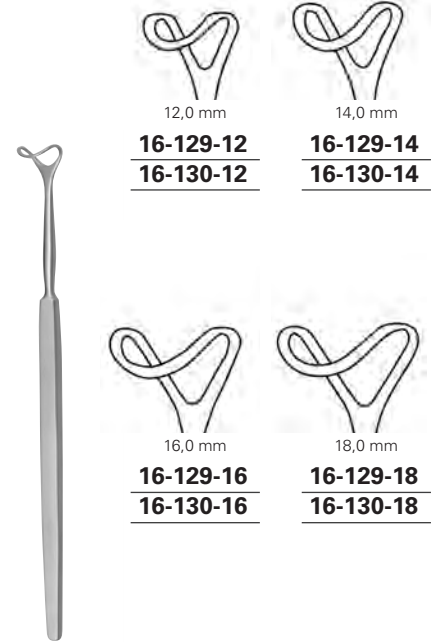
14,0 mm  
**16-127-14**  
**16-128-14**

16,0 mm  
**16-127-16**  
**16-128-16**

18,0 mm  
**16-127-18**  
**16-128-18**

**DESMARRES**

**16-127-08 - 16-127-18** 13,0 cm, 5 1/8"  
**16-128-08 - 16-128-18** 16,0 cm, 6 1/4"



12,0 mm  
**16-129-12**  
**16-130-12**

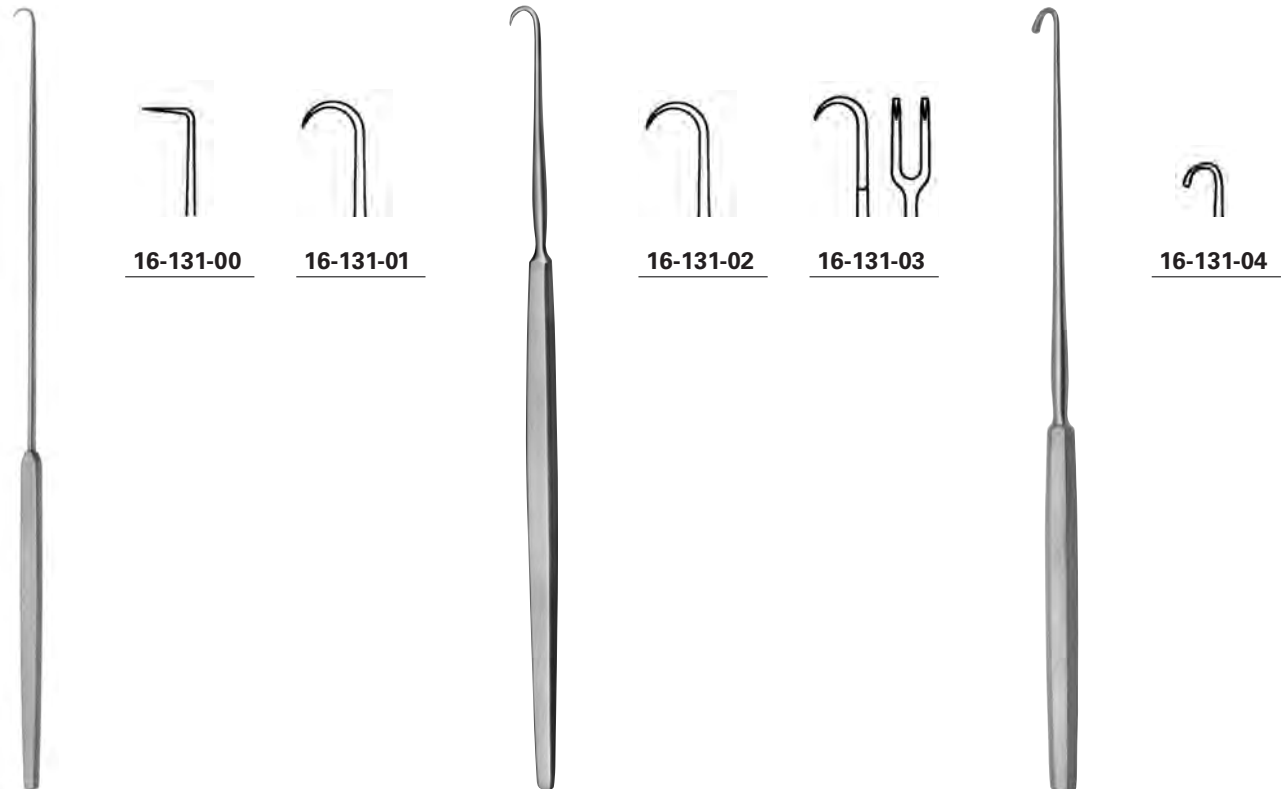
14,0 mm  
**16-129-14**  
**16-130-14**

16,0 mm  
**16-129-16**  
**16-130-16**

18,0 mm  
**16-129-18**  
**16-130-18**

**DESMARRES**

**16-129-12 - 16-129-18** 13,0 cm, 5 1/8"  
**16-130-12 - 16-130-18** 16,0 cm, 6 1/4"



**16-131-00**

**16-131-01**

**16-131-02**

**16-131-03**

**16-131-04**

**EMMET**

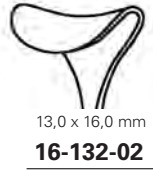
**16-131-00 - 16-131-01** 22,0 cm, 8 3/4"

**SIMON**

**16-131-02 - 16-131-03** 22,0 cm, 8 3/4"

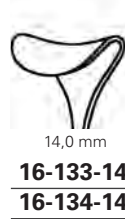
**LANGE**

**16-131-04** 23,0 cm, 9"



**KOENIG**

**16-132-01 - 16-132-02** 18,0 cm, 7 "



**CUSHING**

**16-133-08 - 13-133-08** 20,0 cm, 8 "  
**16-134-08 - 13-134-08** 24,0 cm, 9 ½ "



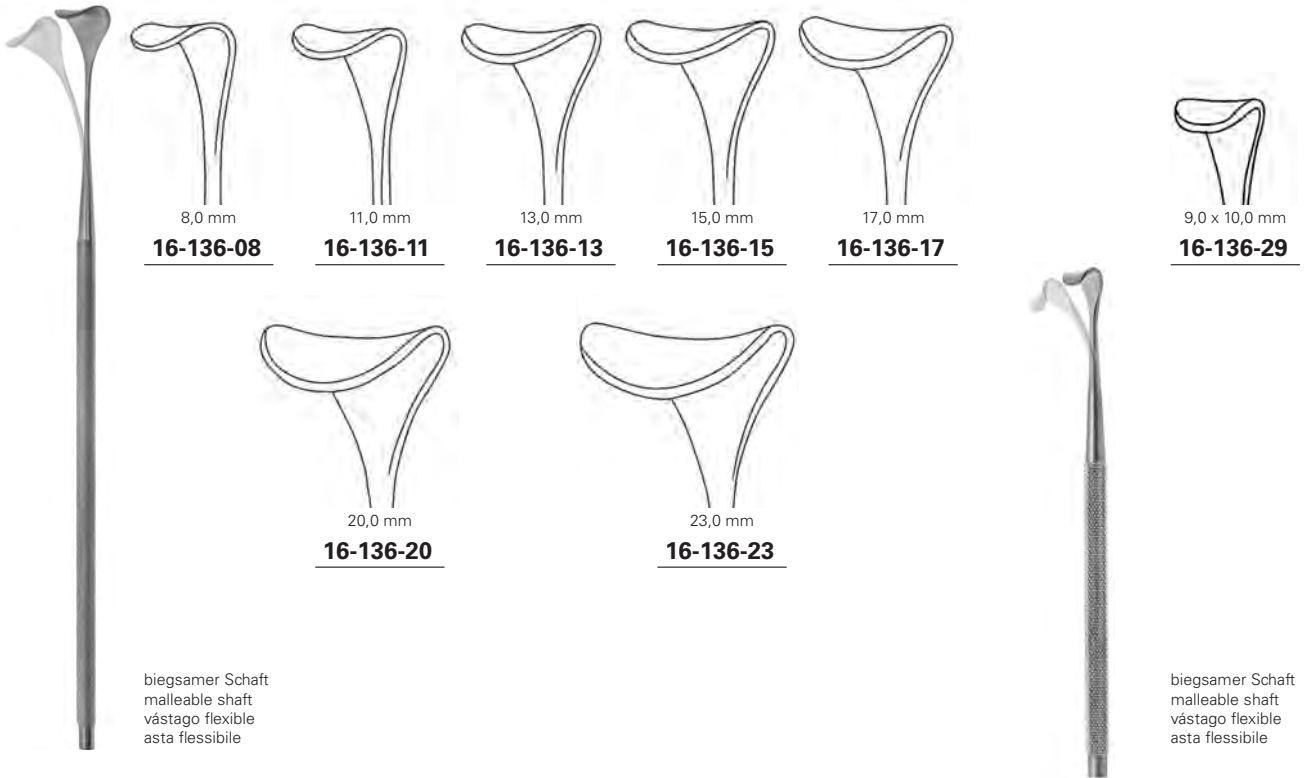
**CUSHING-KOCHER**

**16-135-10** 20,0 cm, 8 "



20,0 x 15,0 mm  
**16-135-20**  
 20,0 x 19,0 mm

**16-135-20** 20,5 cm, 8 "

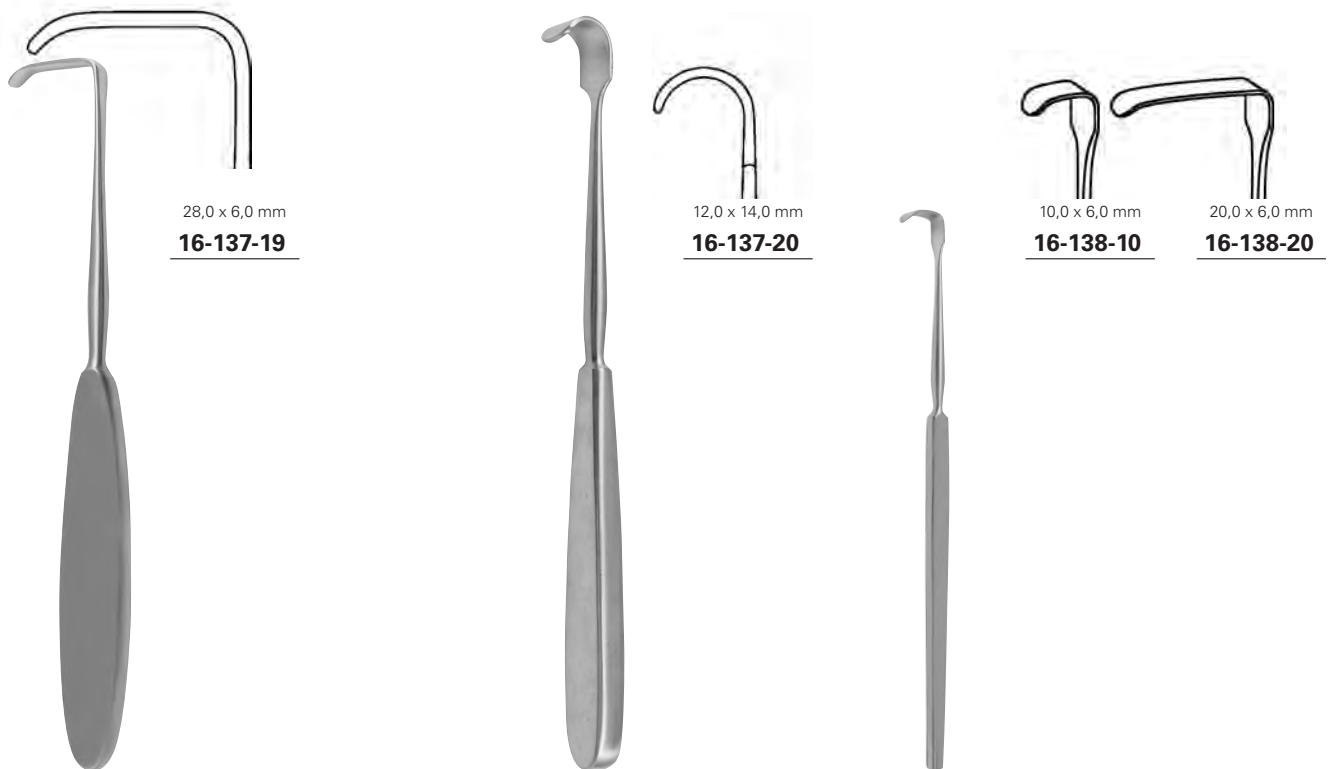


**GILL-VERNET**

**16-136-08 - 13-136-23** 24,0 cm, 9 ½ "

**KIRKLIN**

**16-136-29** 13,5 cm, 5 ¼ "



**LAHEY**

**16-137-19** 19,0 cm, 7 ½ "

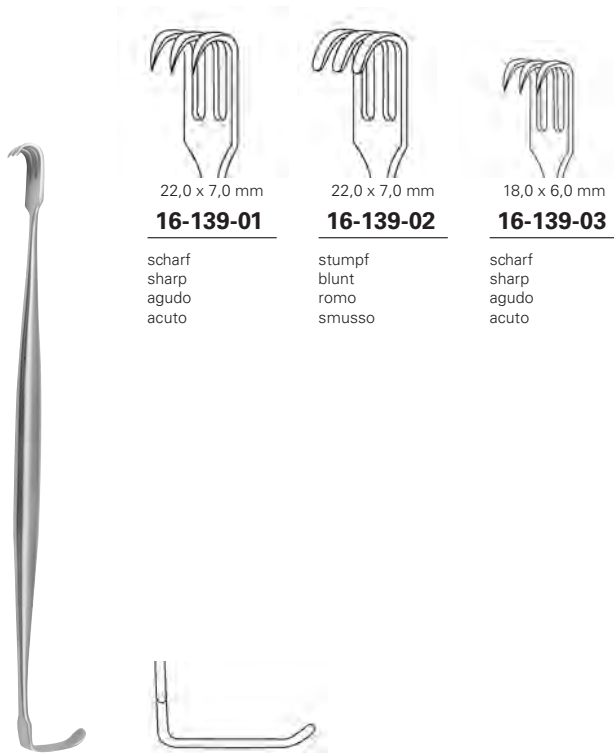
**LITTLE**

**16-137-20** 20,0 cm, 8 "

**SENN-GREEN**

**16-138-10 - 16-138-20** 15,0 cm, 6 "





22,0 x 7,0 mm  
**16-139-01**

scharf  
 sharp  
 agudo  
 acuto

22,0 x 7,0 mm  
**16-139-02**

stumpf  
 blunt  
 romo  
 smusso

18,0 x 6,0 mm  
**16-139-03**

scharf  
 sharp  
 agudo  
 acuto

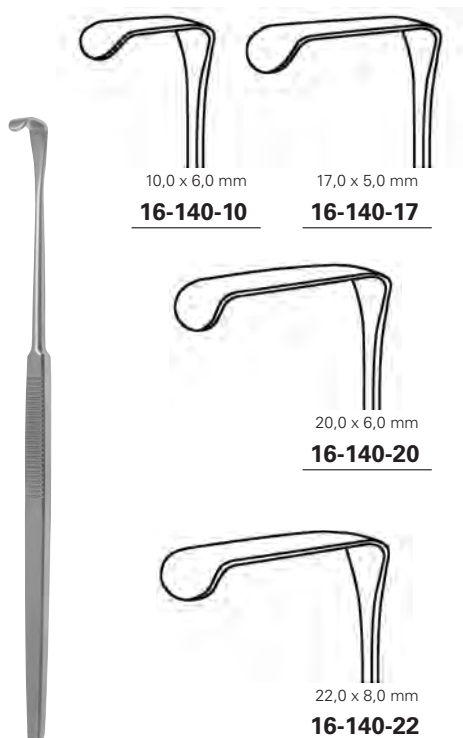
13,0 x 5,0 mm  
**16-139-04**

### SENN-MILLER

**16-139-01 - 16-139-03** 16,0 cm, 6 ¼ "

### KILNER

**16-139-04** 15,5 cm, 6 "



10,0 x 6,0 mm  
**16-140-10**

17,0 x 5,0 mm  
**16-140-17**

20,0 x 6,0 mm  
**16-140-20**

22,0 x 8,0 mm  
**16-140-22**

**16-141-01**

scharf  
 sharp  
 agudo  
 acuto

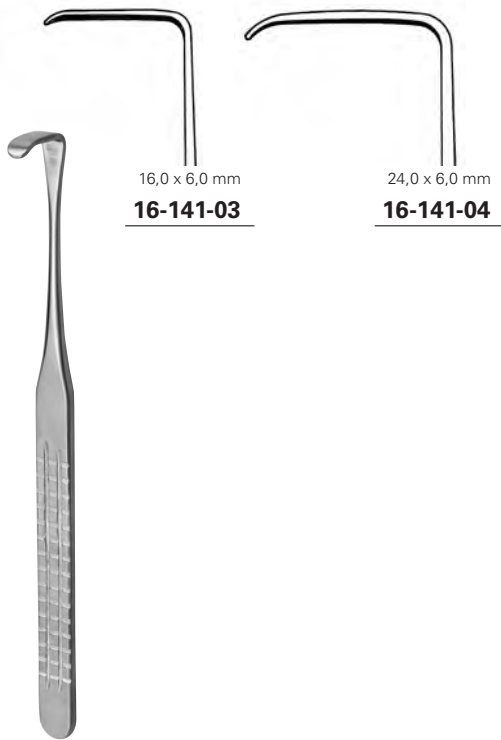
**16-141-02**

scharf  
 sharp  
 agudo  
 acuto

### MINI-LANGENBECK

**16-140-10 - 16-140-22** 16,0 cm, 6 ¼ "

**16-141-01 - 16-141-02** 16,0 cm, 6 ¼ "



16,0 x 6,0 mm  
**16-141-03**

24,0 x 6,0 mm  
**16-141-04**



10,0 x 13,0 mm  
**16-141-05**

**16-141-03 - 16-141-04** 16,0 cm, 6 ¼"

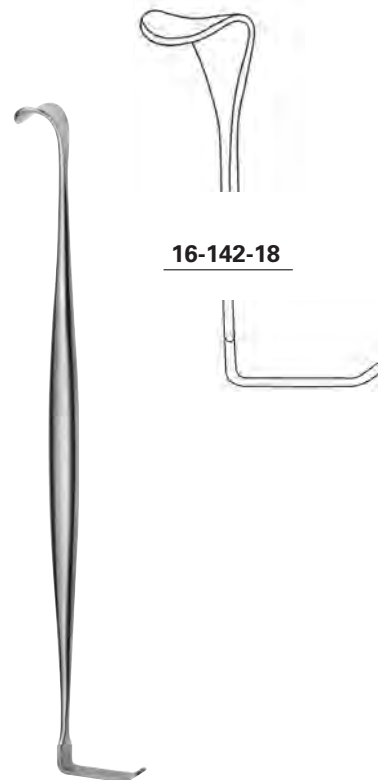
**16-141-05** 16,0 cm, 6 ¼"



8,0 x 4,0 mm  
**16-142-14**  
15,0 x 5,5 mm

**RAGNELL-DAVIS**

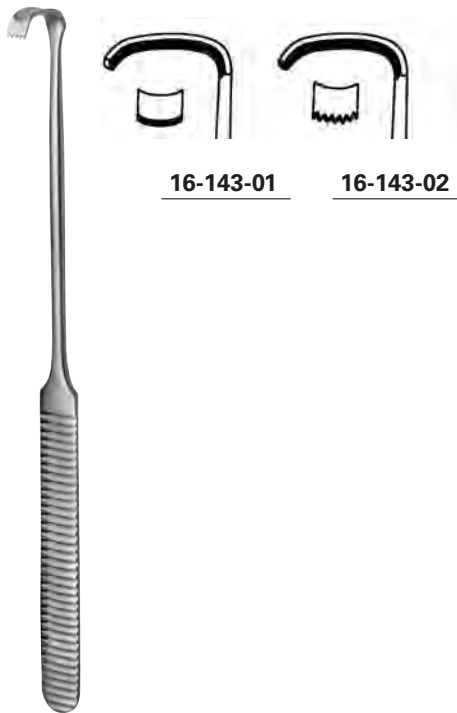
**16-142-14** 14,0 cm, 5 ½"



**16-142-18**

**COPE**

**16-142-18** 18,0 cm, 7"

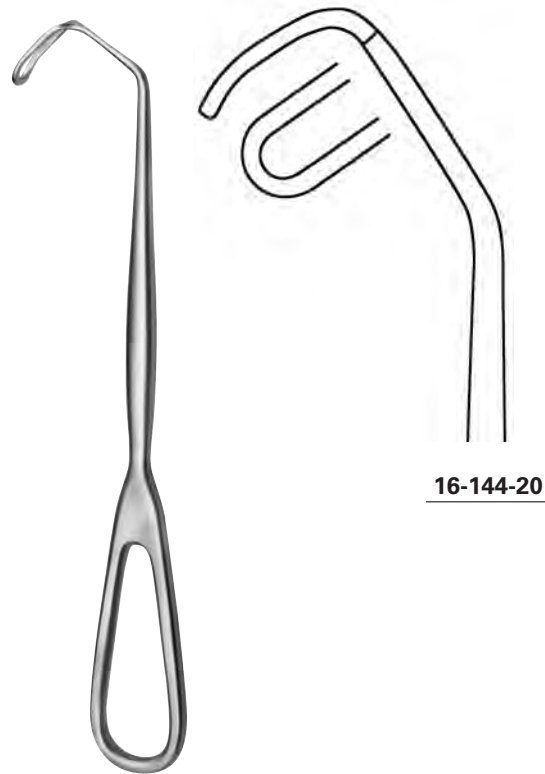


**16-143-01**

**16-143-02**

**STRANDELL-STILLE**

**16-143-01 - 16-143-02** 19,0 cm, 7 1/2"



**16-144-20**

**CUSHING**

**16-144-20** 20,0 cm, 8"

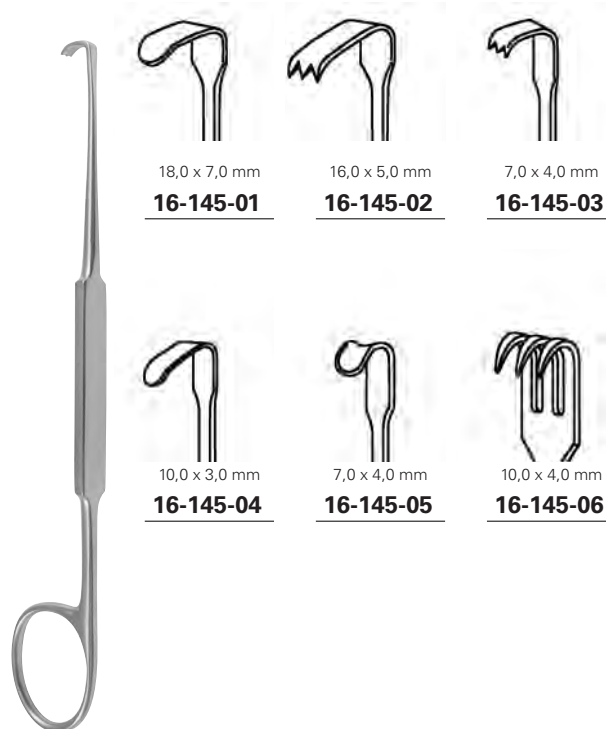


11,0 x 12,0 mm

**16-144-21**

**CUSHING**

**16-144-21** 21,0 cm, 8 1/4"



18,0 x 7,0 mm

**16-145-01**

16,0 x 5,0 mm

**16-145-02**

7,0 x 4,0 mm

**16-145-03**

10,0 x 3,0 mm

**16-145-04**

7,0 x 4,0 mm

**16-145-05**

10,0 x 4,0 mm

**16-145-06**

**MEYERDING**

**16-145-01 - 16-145-06** 18,0 cm, 7"



**16-146-01**

scharf  
sharp  
agudo  
acuto

**16-148-01**

stumpf  
blunt  
romo  
smusso



**16-146-02**

scharf  
sharp  
agudo  
acuto



**16-148-02**

stumpf  
blunt  
romo  
smusso



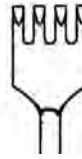
**16-146-03**

scharf  
sharp  
agudo  
acuto



**16-148-03**

stumpf  
blunt  
romo  
smusso



**16-146-04**

scharf  
sharp  
agudo  
acuto



**16-148-04**

stumpf  
blunt  
romo  
smusso



**16-146-06**

scharf  
sharp  
agudo  
acuto



**16-148-06**

stumpf  
blunt  
romo  
smusso

**16-146-01 - 16-148-06** 17,0 cm, 6  $\frac{3}{4}$  "



**16-149-15**

**BARSKY**

**16-149-15** 15,0 cm, 6 "



**16-150-16**

**KILNER**

**16-150-16** 16,0 cm, 6  $\frac{1}{4}$  "



**16-152-01**

**GILLIES**

**16-152-01 - 16-152-02** 18,0 cm, 7 "



**16-152-02**



**16-154-01**



2,0 mm  
**16-154-02**



5,0 mm  
**16-154-03**



7,0 mm  
**16-154-04**



10,0 mm  
**16-154-05**

## JOSEPH

**16-154-01 - 16-154-05** 16,0 cm, 6 ¼"



9,0 mm  
**16-154-09**



10,0 mm  
**16-154-10**



**16-156-15**

## MC INDOE

**16-154-09 - 16-154-10** 15,0 cm, 6"

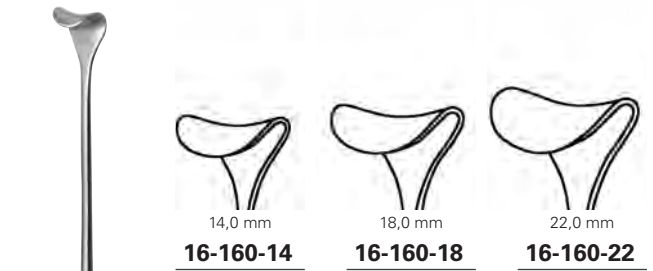
## FREER

**16-156-15** 15,0 cm, 6"



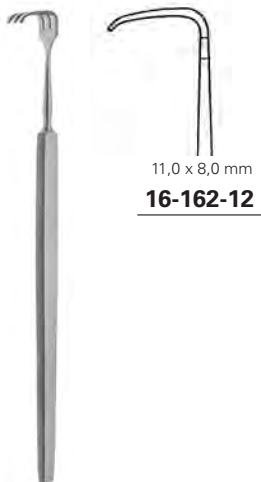
**KLEINERT-KUTZ**

**16-158-01 - 16-158-03** 13,0 cm, 5 1/8"



**CUSHING**

**16-160-14 - 16-160-22** 25,0 cm, 9 3/4"



**PAUL**

**16-162-12** 12,0 cm, 4 3/4"



**KAYE-MILLARD**

**16-164-08** 8,0 cm, 3"



### MUELLER

**16-201-05** 6,5 cm, 2 1/3"



### BOSE

**16-202-06** 6,0 cm, 2 1/4"



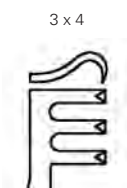
### FINSEN

**16-203-05 - 16-204-05** 5,0 cm, 2"  
**16-203-07 - 16-204-07** 7,0 cm, 2 3/4"



### FINSEN

**16-206-07 - 16-207-07** 7,0 cm, 2 3/4"



**16-206-07**

scharf  
sharp  
agudo  
acuto



**16-207-07**

stumpf  
blunt  
romo  
smusso



### HOLZHEIMER

**16-209-10 - 16-210-10** 10,0 cm, 4"

4 x 4



**16-209-10**

scharf  
sharp  
agudo  
acuto

4 x 4



**16-210-10**

stumpf  
blunt  
romo  
smusso



2 x 3

**16-203-05**

3 x 4

**16-203-07**

scharf  
sharp  
agudo  
acuto



2 x 3

**16-204-05**

3 x 4

**16-204-07**

stumpf  
blunt  
romo  
smusso



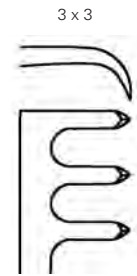
**16-212-07**  
**16-212-10**

scharf  
sharp  
agudo  
acuto



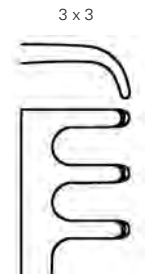
**16-213-07**  
**16-213-10**

stumpf  
blunt  
romo  
smusso



**16-214-06**

scharf  
sharp  
agudo  
acuto



**16-215-06**

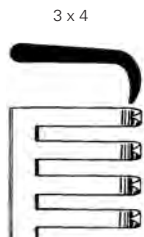
stumpf  
blunt  
romo  
smusso

### ALM

**16-212-07 - 16-213-07** 7,0 cm, 2 3/4"  
**16-212-10 - 16-213-10** 10,0 cm, 4"

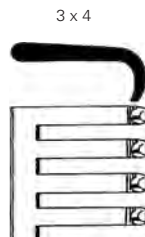
### JANSEN

**16-214-06 - 16-215-06** 10,0 cm, 4"



**16-216-14**

scharf  
sharp  
agudo  
acuto



**16-216-15**

stumpf  
blunt  
romo  
smusso



**16-217-10**

scharf  
sharp  
agudo  
acuto



**16-218-10**

stumpf  
blunt  
romo  
smusso

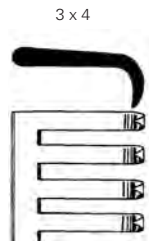
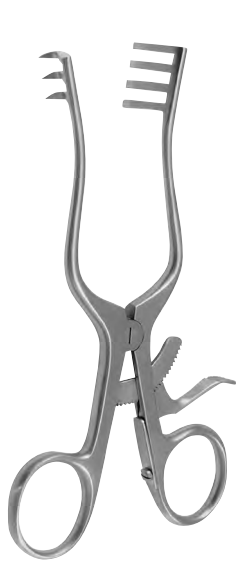
### SCALP-CONTOUR

**16-216-14 - 16-216-15** 14,0 cm, 5 1/2"

### WEITLANER

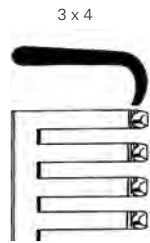
**16-217-10 - 16-218-10** 11,0 cm, 4 1/4"





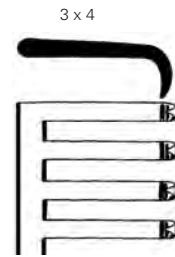
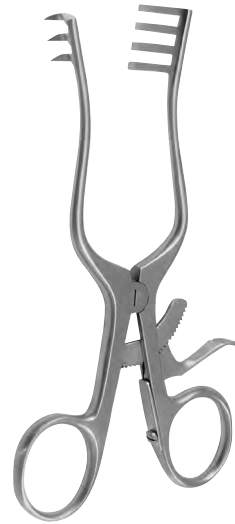
**16-217-13**  
**16-217-16**

scharf  
sharp  
agudo  
acuto



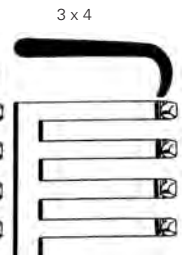
**16-218-13**  
**16-218-16**

stumpf  
blunt  
romo  
smusso



**16-217-14**

scharf  
sharp  
agudo  
acuto



**16-218-14**

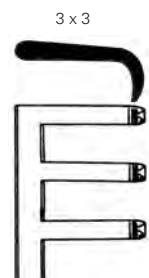
stumpf  
blunt  
romo  
smusso

## WEITLANER

**16-217-13 - 16-218-13** 13,5 cm, 5 ¼"  
**16-217-16 - 16-218-16** 16,0 cm, 6 ¼"

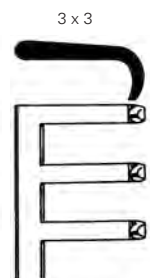
## WEITLANER

**16-217-14 - 16-218-14** 13,5 cm, 5 ¼"



**16-219-11**  
**16-219-13**

scharf  
sharp  
agudo  
acuto



**16-220-11**  
**16-220-13**

stumpf  
blunt  
romo  
smusso



**16-221-15**

scharf  
sharp  
agudo  
acuto

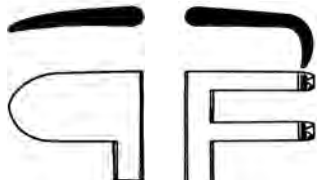
## WULLSTEIN

**16-219-11 - 16-220-11** 11,0 cm, 4 ¼"  
**16-219-13 - 16-220-13** 13,0 cm, 5"

## MOLLISON

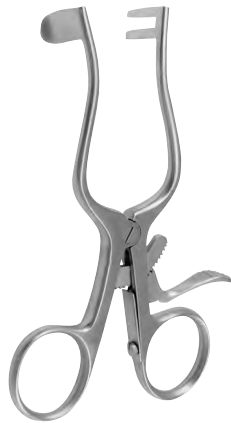
**16-221-15** 15,5 cm, 6"

1 x 2



**16-224-11**  
**16-224-13**

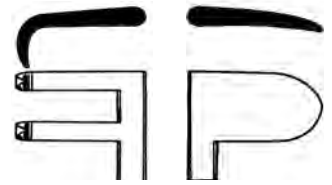
scharf  
sharp  
agudo  
acuto



**PLESTER**

**16-224-11** 11,0 cm, 4 ¼"  
**16-224-13** 13,0 cm, 5"

1 x 2



**16-225-11**  
**16-225-13**

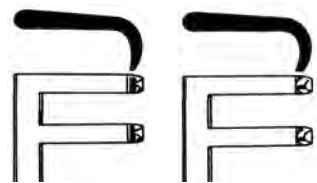
scharf  
sharp  
agudo  
acuto



**PLESTER**

**16-225-11** 11,0 cm, 4 ¼"  
**16-225-13** 13,0 cm, 5"

2 x 2



**16-222-11**  
**16-222-13**

scharf  
sharp  
agudo  
acuto

**16-223-11**  
**16-223-13**

stumpf  
blunt  
romo  
smusso



**PLESTER**

**16-222-11 - 16-223-11** 11,0 cm, 4 ¼"  
**16-222-13 - 16-223-13** 13,0 cm, 5"

1 x 3



**16-226-13**

scharf  
sharp  
agudo  
acuto

1 x 3



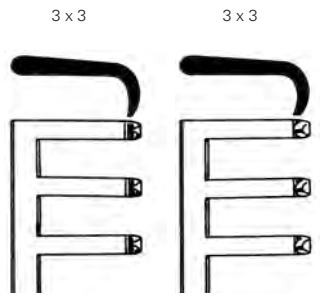
**16-226-14**

scharf  
sharp  
agudo  
acuto



**PERKINS**

**16-226-13 - 16-226-14** 13,0 cm, 5"



**16-227-13**

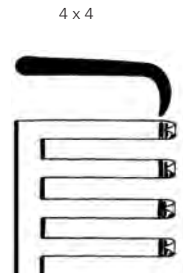
scharf  
sharp  
agudo  
acuto

**16-228-13**

stumpf  
blunt  
rombo  
smusso

**MILIGAN**

**16-227-13 - 16-228-13** 13,0 cm, 5"

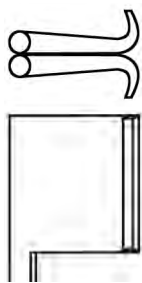


**16-229-17**

scharf  
sharp  
agudo  
acuto

**HENDERSON**

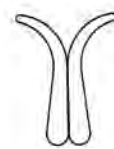
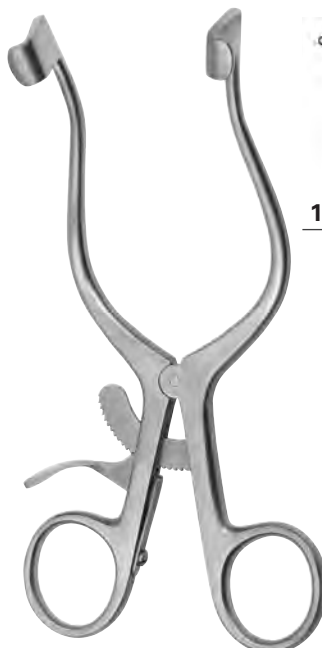
**16-229-17** 17,0 cm, 6 3/4"



**16-230-13**

**WEITLANER-BABY**

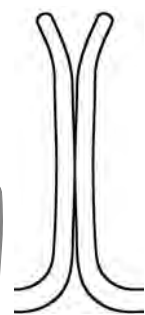
**16-230-13** 13,5 cm, 5 1/4"



**16-231-16**

**MOD. TUEBINGEN**

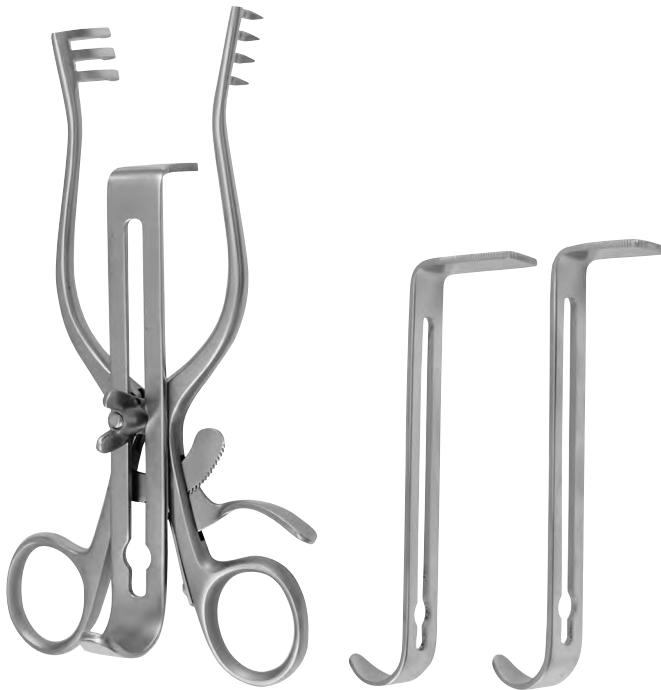
**16-231-16** 16,5 cm, 6 1/2"



**16-232-17**

**MAYO-ADAMS**

**16-232-17** 16,5 cm, 6 1/2"



**HENLEY**

**16-234-00** SET

Wundspreizer komplett,  
bestehend aus:

- 1 Wundspreizer, scharf **16-234-01**
- 1 Mittelvalve, 19 x 16 mm **16-236-19**
- 1 Mittelvalve, 25 x 16 mm **16-236-25**
- 1 Mittelvalve, 32 x 16 mm **16-236-32**

Self-retaining retractor complete,  
consisting of:

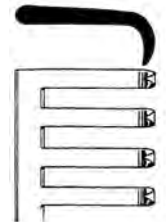
- 1 Retractor, sharp **16-234-01**
- 1 Central valve 19 x 16 mm **16-236-19**
- 1 Central valve 25 x 16 mm **16-236-25**
- 1 Central valve 32 x 16 mm **16-236-32**

Seperador autoestáticos completo,  
compuesto de:

- 1 Seperador, agudas **16-234-01**
- 1 Valva central 19 x 16 mm **16-236-19**
- 1 Valva central 25 x 16 mm **16-236-25**
- 1 Valva central 32 x 16 mm **16-236-32**

Divaricatore autostatici completo,  
composto da:

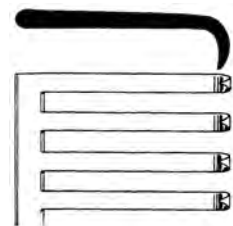
- 1 Divaricatore, acuto **16-234-01**
- 1 Valva centrale 19 x 16 mm **16-236-19**
- 1 Valva centrale 25 x 16 mm **16-236-25**
- 1 Valva centrale 32 x 16 mm **16-236-32**



scharf, 15 mm  
sharp, 15 mm  
agudo, 15 mm  
acuto, 15 mm

**HENLEY**

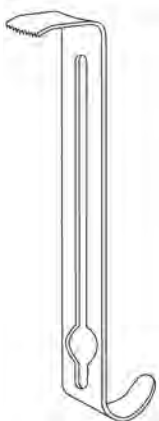
**16-234-01** 16,0 cm, 6 ¼ "



scharf, 25 mm  
sharp, 25 mm  
agudo, 25 mm  
acuto, 25 mm

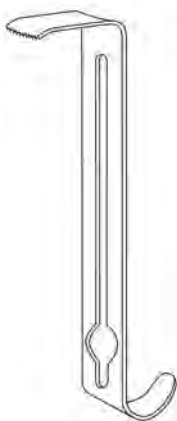
**HENLEY**

**16-234-02** 16,0 cm, 6 ¼ "



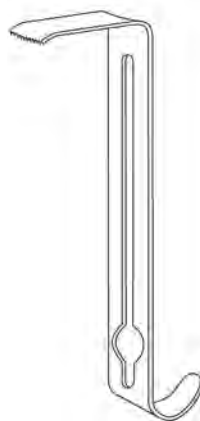
**16-236-19**

19 x 16 mm



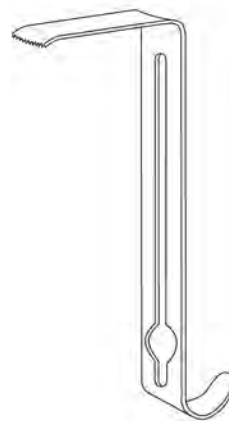
**16-236-25**

25 x 16 mm



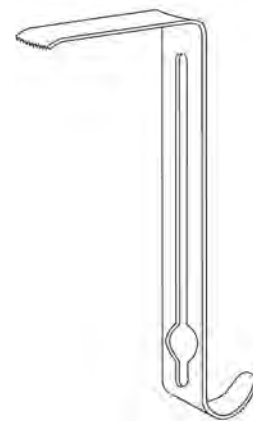
**16-236-32**

32 x 16 mm



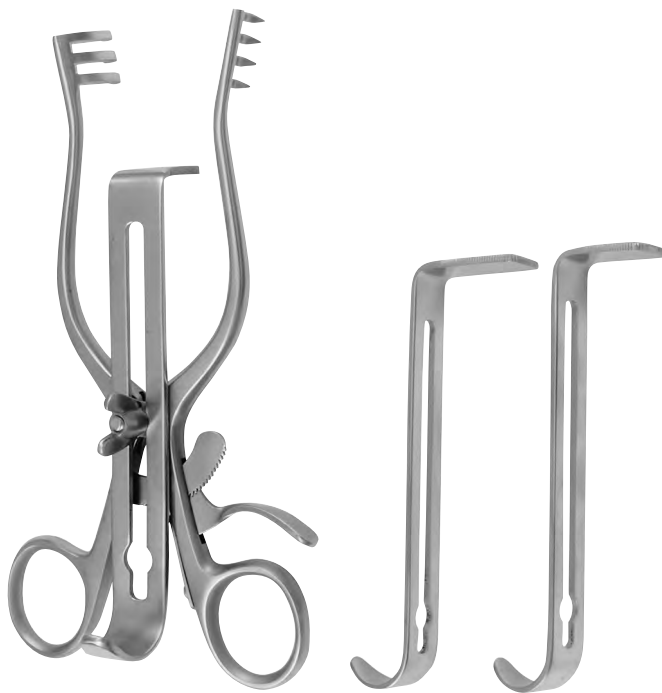
**16-236-40**

40 x 16 mm



**16-236-45**

45 x 16 mm



## HENLEY

**16-235-00** SET

Wundspreizer komplett,  
 bestehend aus:

1 Wundspreizer, stumpf	<b>16-235-01</b>
1 Mittelvalve, 19 x 16 mm	<b>16-236-19</b>
1 Mittelvalve, 25 x 16 mm	<b>16-236-25</b>
1 Mittelvalve, 32 x 16 mm	<b>16-236-32</b>

Seperador autoestáticos completo,  
 compuesto de:

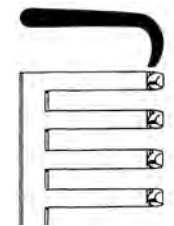
1 Seperador, romas	<b>16-235-01</b>
1 Valva central 19 x 16 mm	<b>16-236-19</b>
1 Valva central 25 x 16 mm	<b>16-236-25</b>
1 Valva central 32 x 16 mm	<b>16-236-32</b>

Self-retaining retractor complete,  
 consisting of:

1 Retractor, blunt	<b>16-235-01</b>
1 Central valve 19 x 16 mm	<b>16-236-19</b>
1 Central valve 25 x 16 mm	<b>16-236-25</b>
1 Central valve 32 x 16 mm	<b>16-236-32</b>

Divaricatore autostatici completo,  
 composto da:

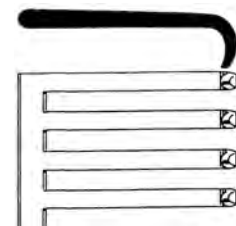
1 Divaricatore, smusso	<b>16-235-01</b>
1 Valva centrale 19 x 16 mm	<b>16-236-19</b>
1 Valva centrale 25 x 16 mm	<b>16-236-25</b>
1 Valva centrale 32 x 16 mm	<b>16-236-32</b>



stumpf, 15 mm  
 blunt, 15 mm  
 romo, 15 mm  
 smusso, 15 mm

## HENLEY

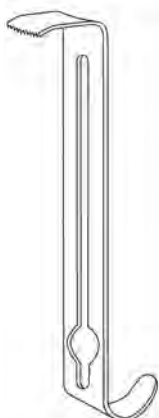
**16-235-01** 16,0 cm, 6 ¼ "



stumpf, 25 mm  
 blunt, 25 mm  
 romo, 25 mm  
 smusso, 25 mm

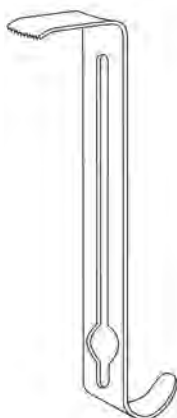
## HENLEY

**16-235-02** 16,0 cm, 6 ¼ "



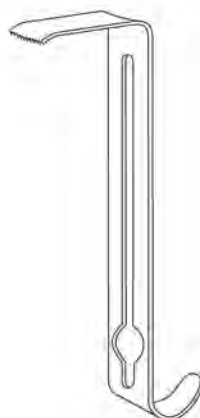
**16-236-19**

19 x 16 mm



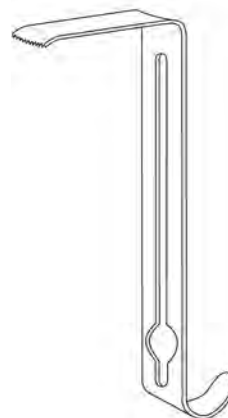
**16-236-25**

25 x 16 mm



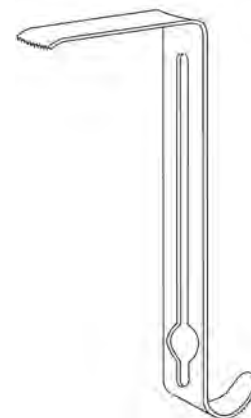
**16-236-32**

32 x 16 mm



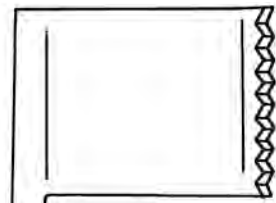
**16-236-40**

40 x 16 mm

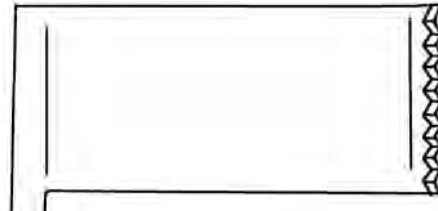


**16-236-45**

45 x 16 mm



32 x 25 mm  
**16-237-01**



54 x 25 mm  
**16-237-02**



60 x 19 mm  
**16-237-03**



60 x 25 mm  
**16-237-04**

**MEYERDING**

**16-237-01 - 16-237-04** 20,0 cm, 8"

80 x 40 mm

68 x 25 mm



**DARLING**

**16-239-01** 18,0 cm, 7"

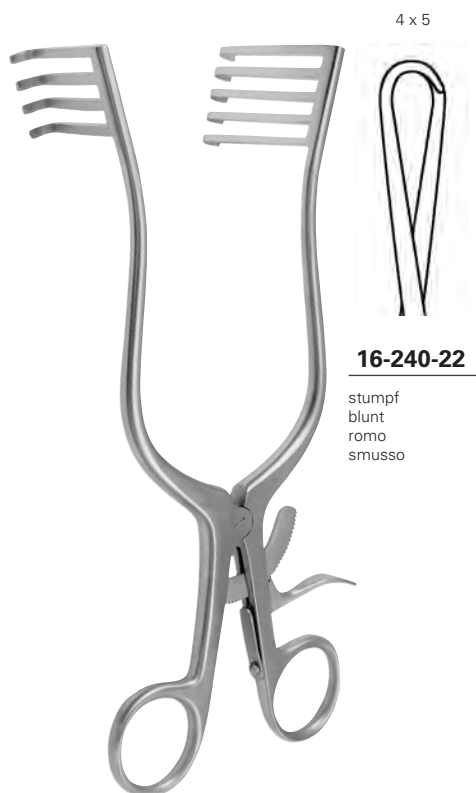
68 x 25 mm

80 x 40 mm



**DARLING**

**16-239-02** 18,0 cm, 7"

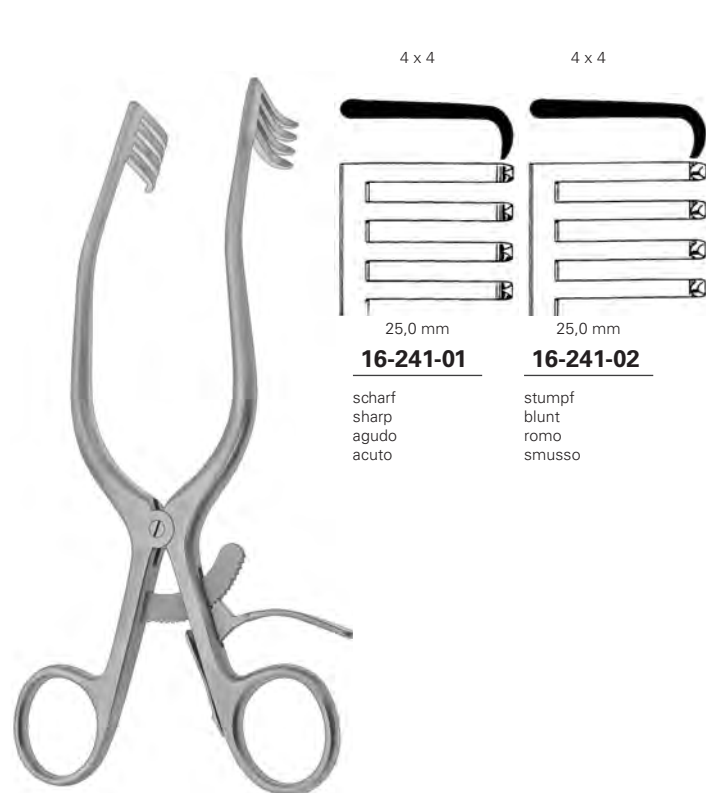


**16-240-22**

stumpf  
 blunt  
 romo  
 smusso

**NORFOLK & NORWICH**

**16-240-22** 22,0 cm, 8 3/4"



**16-241-01**

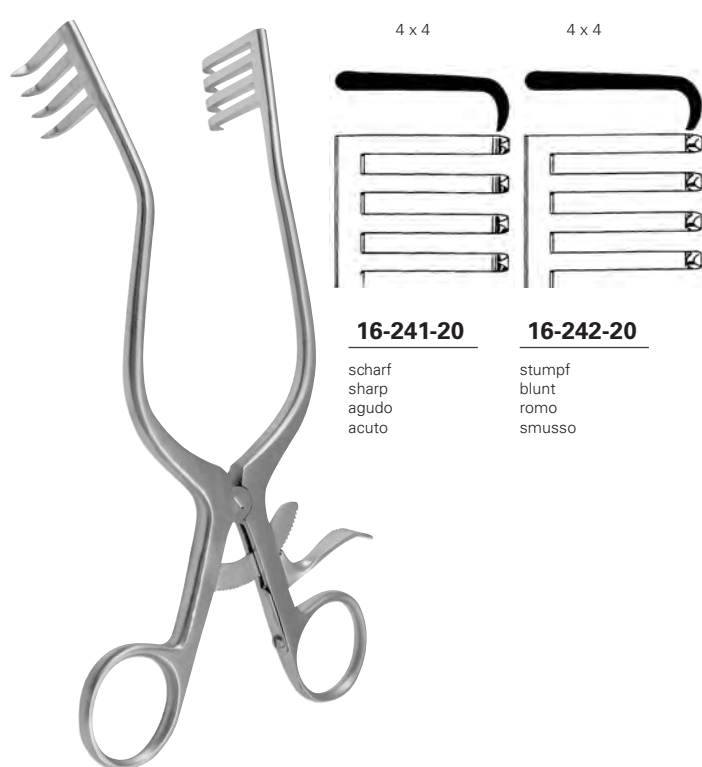
scharf  
 sharp  
 agudo  
 acuto

**16-241-02**

stumpf  
 blunt  
 romo  
 smusso

**ADSON**

**16-241-01 - 16-241-02** 20,0 cm, 8"



**16-241-20**

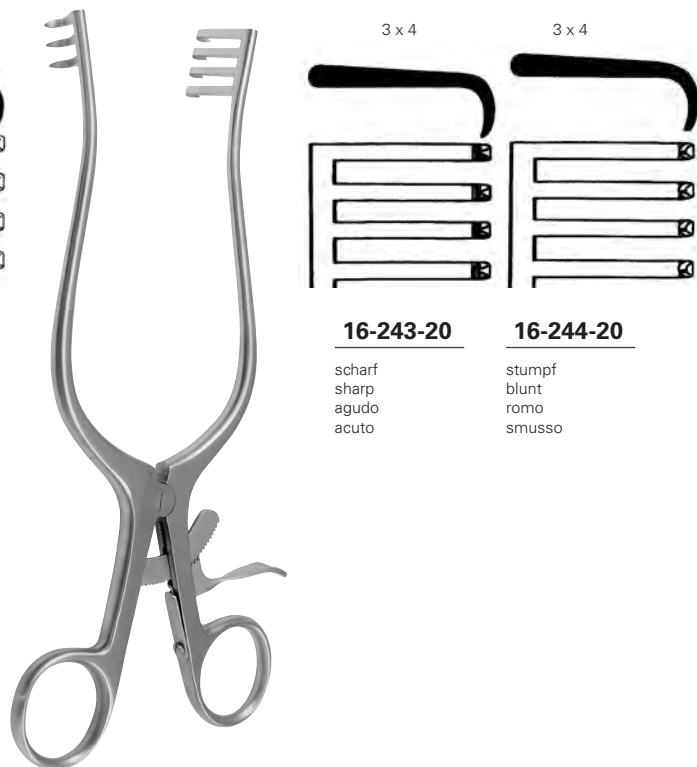
scharf  
 sharp  
 agudo  
 acuto

**16-242-20**

stumpf  
 blunt  
 romo  
 smusso

**ANDERSON-ADSON**

**16-241-20 - 16-242-20** 20,0 cm, 8"



**16-243-20**

scharf  
 sharp  
 agudo  
 acuto

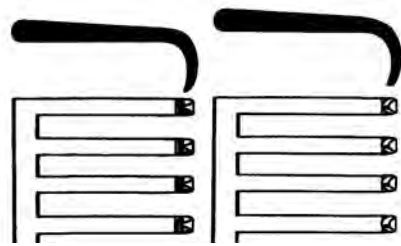
**16-244-20**

stumpf  
 blunt  
 romo  
 smusso

**WEITLANER**

**16-243-20 - 16-244-20** 20,0 cm, 8"





3 x 4  
**16-243-24**  
5 x 6  
**16-243-26**

scharf  
sharp  
agudo  
acuto

3 x 4  
**16-244-24**  
5 x 6  
**16-244-26**

stumpf  
blunt  
romo  
smusso

**WEITLANER**

**16-243-24 - 16-244-24** 24,0 cm, 9 1/2"  
**16-243-26 - 16-244-26** 26,0 cm, 10 1/4"



7 x 7  
**16-245-20**

scharf  
sharp  
agudo  
acuto

7 x 7  
**16-245-19**

stumpf  
blunt  
romo  
smusso

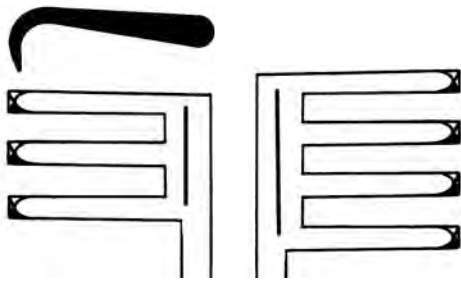
**MISKIMON**

**16-245-19 - 16-245-20** 22,0 cm, 8 3/4"





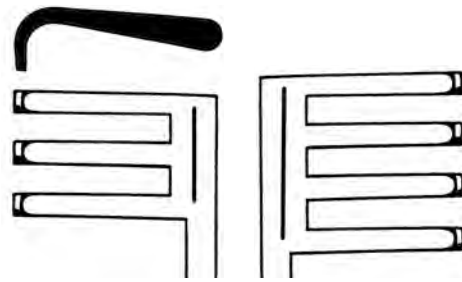
3 x 4



**16-246-07**

scharf  
 sharp  
 agudo  
 acuto

3 x 4

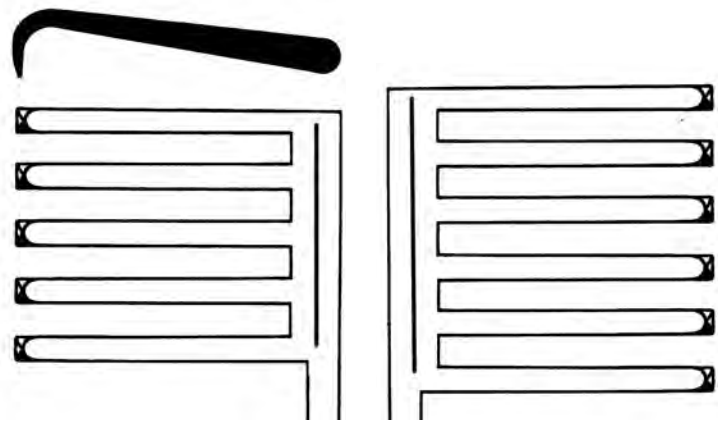


**16-247-07**

stumpf  
 blunt  
 romo  
 smusso



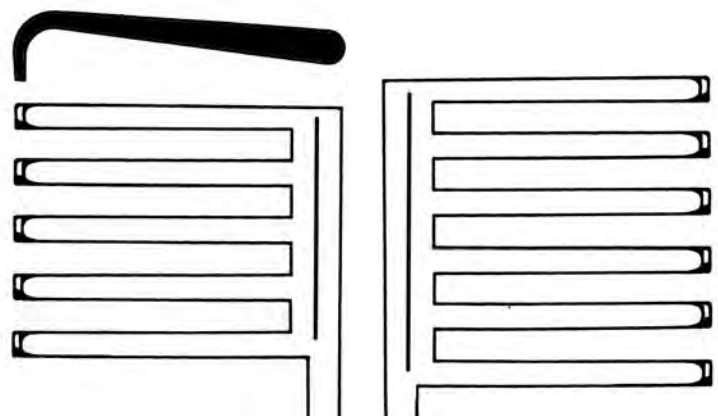
5 x 6



**16-246-12**

scharf  
 sharp  
 agudo  
 acuto

5 x 6



**16-247-12**

stumpf  
 blunt  
 romo  
 smusso

**ADSON**

**16-246-07 - 16-247-07** 26,0 cm, 10 1/4"  
**16-246-12 - 16-247-12** 29,0 cm, 11 1/2"



4 x 5



**16-245-21**

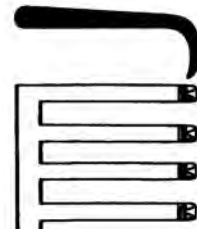
stumpf  
blunt  
rombo  
smusso

**TRAVERS**

**16-245-21** 21,0 cm, 8 ¼"



4 x 4



**16-246-01**

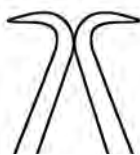
scharf  
sharp  
agudo  
acuto

**IRWIN**

**16-246-01** 17,5 cm, 7"



1 x 1



**16-248-09**

**16-248-11**

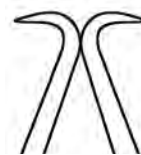
**GELPI-LOKTITE**

**16-248-09** 9,0 cm, 3 ½"

**16-248-11** 11,0 cm, 4 ⅜"



1 x 1



**16-248-13**

**GELPI-LOKTITE**

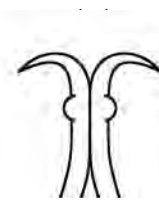
**16-248-13** 13,5 cm, 5 ¼"



**16-248-16**  
**16-248-18**

### GELPI-LOKTITE

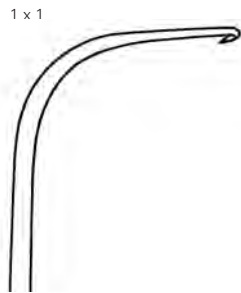
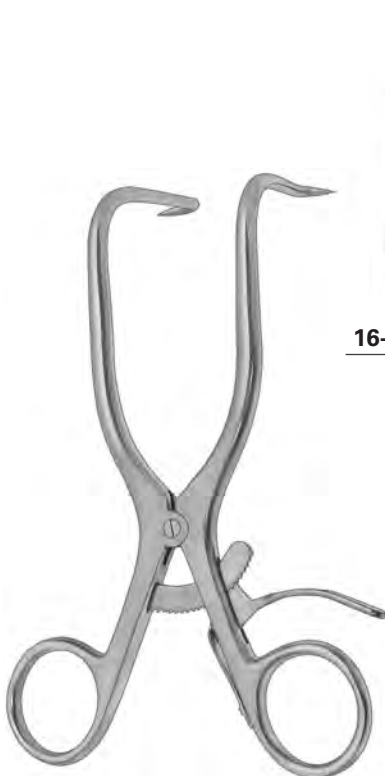
**16-248-16** 16,0 cm, 6 ¼"  
**16-248-18** 18,0 cm, 7"



**16-249-18**

### GELPI-LOKTITE

**16-249-18** 18,0 cm, 7"



**16-250-15**

### GELPI-SEILETZ

**16-250-15** 15,0 cm, 6"



**16-250-18**

### JACKSON-BURROWS

**16-250-18** 18,5 cm, 7 ¼"



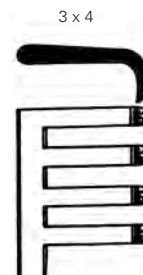
**RIGBY**

**16-251-18** 18,0 cm, 7"



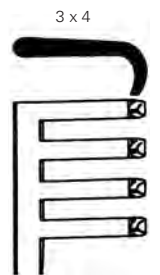
**ADSON**

**16-252-13 - 16-253-13** 13,5 cm, 5 1/4"  
**16-252-16 - 16-253-16** 16,5 cm, 6 1/2"



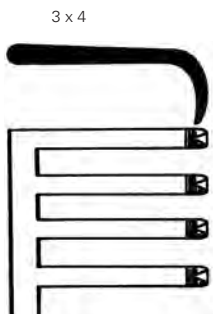
**16-252-13**  
**16-252-16**

scharf  
 sharp  
 agudo  
 acuto



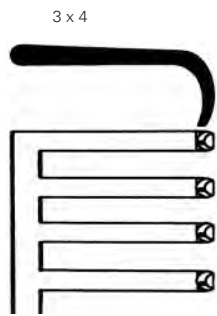
**16-253-13**  
**16-253-16**

stumpf  
 blunt  
 romo  
 smusso



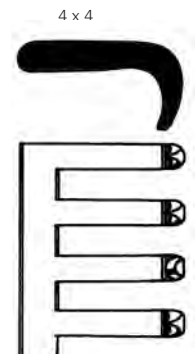
**16-252-26**

scharf  
 sharp  
 agudo  
 acuto



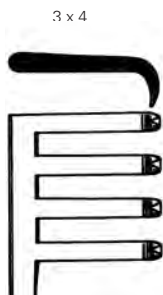
**16-253-26**

stumpf  
 blunt  
 romo  
 smusso



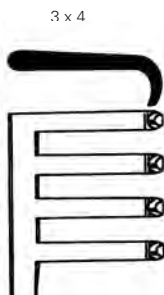
**16-256-31**

stumpf  
 blunt  
 romo  
 smusso



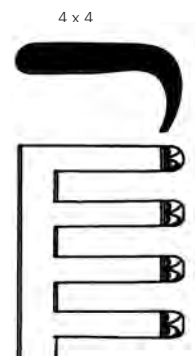
**16-252-20**

scharf  
 sharp  
 agudo  
 acuto



**16-253-20**

stumpf  
 blunt  
 romo  
 smusso



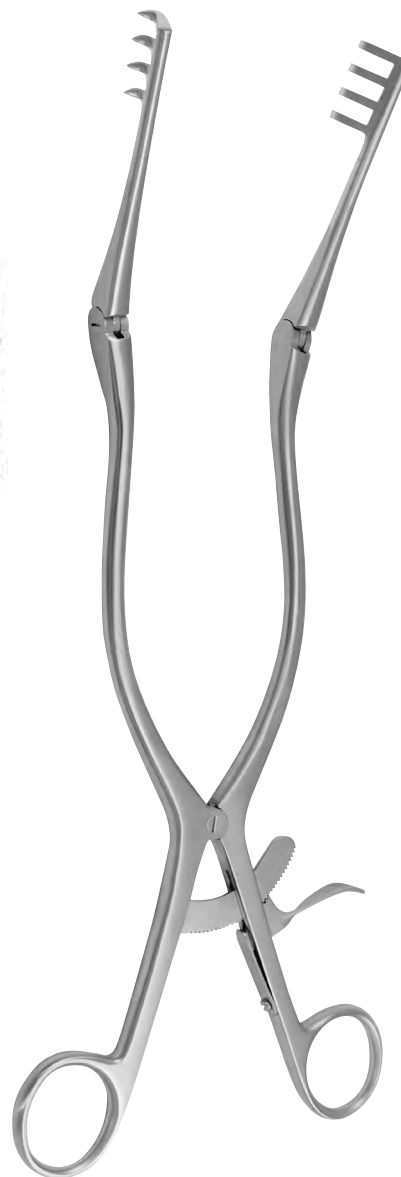
**16-255-31**

scharf  
 sharp  
 agudo  
 acuto



**ADSON**

**16-252-20 - 16-253-20** 21,0 cm, 8 1/4"  
**16-252-26 - 16-253-26** 24,5 cm, 9 3/4"



**BECKMANN**

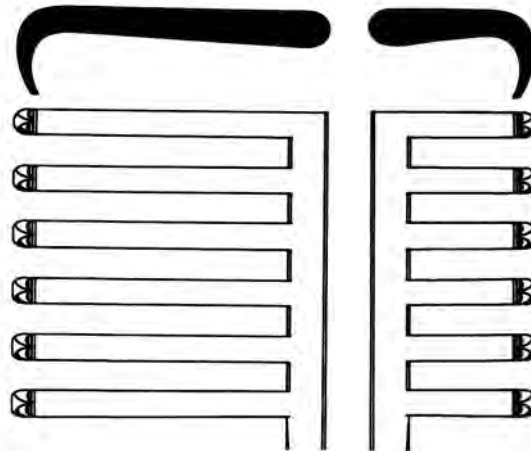
**16-255-31 - 16-256-31** 31,0 cm, 12 1/4"



**ADSON**

**16-254-01 - 16-254-02** 28,5 cm, 11 1/4"

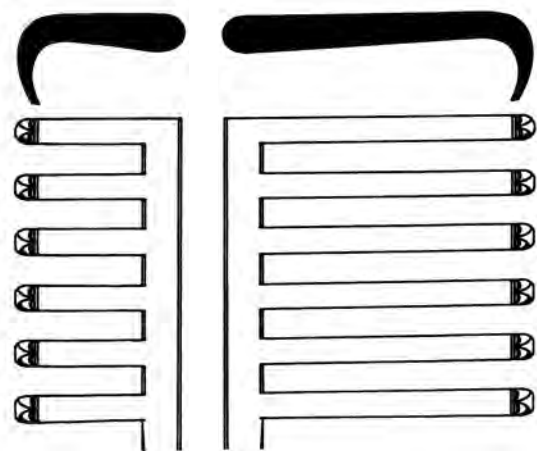
6 x 6



**16-254-01**

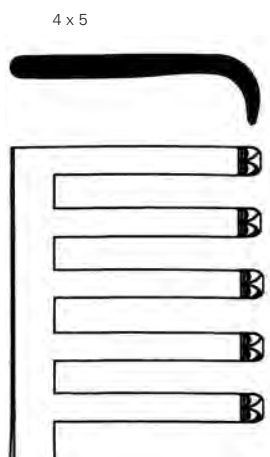
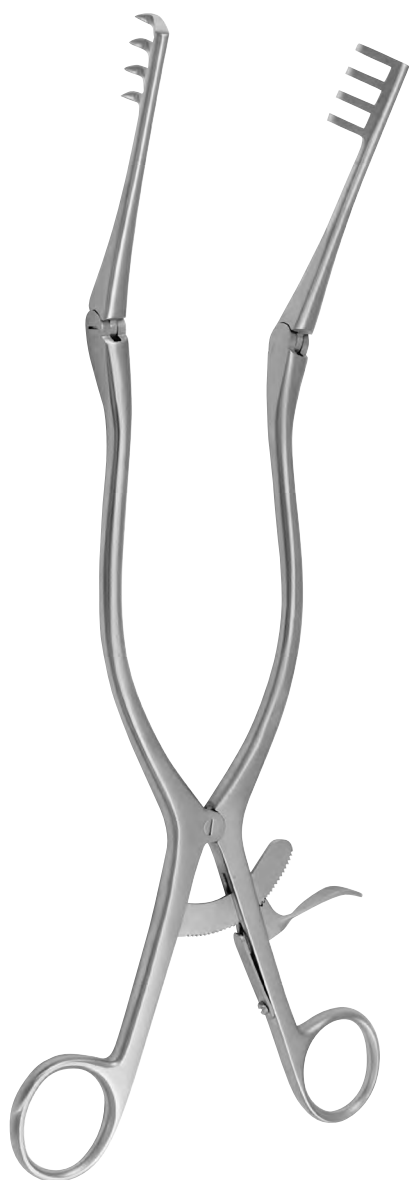
scharf  
sharp  
agudo  
acuto

6 x 6



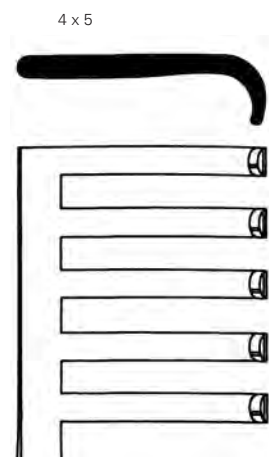
**16-254-02**

scharf  
sharp  
agudo  
acuto



**16-257-32**

scharf  
sharp  
agudo  
acuto



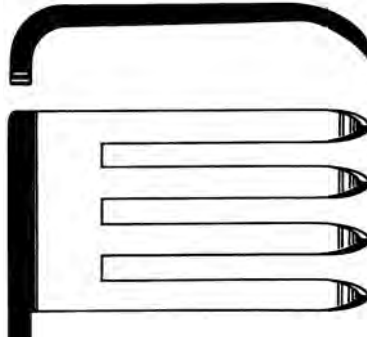
**16-258-32**

stumpf  
blunt  
romo  
smusso

## ADSON

**16-257-32 - 16-258-32** 32,0 cm, 12½"

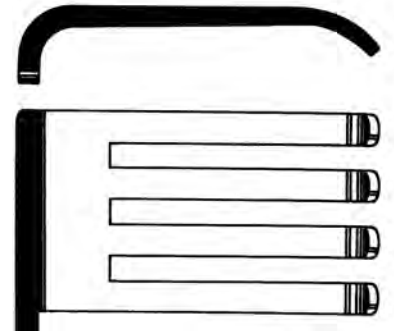
4 x 4



**16-260-01**

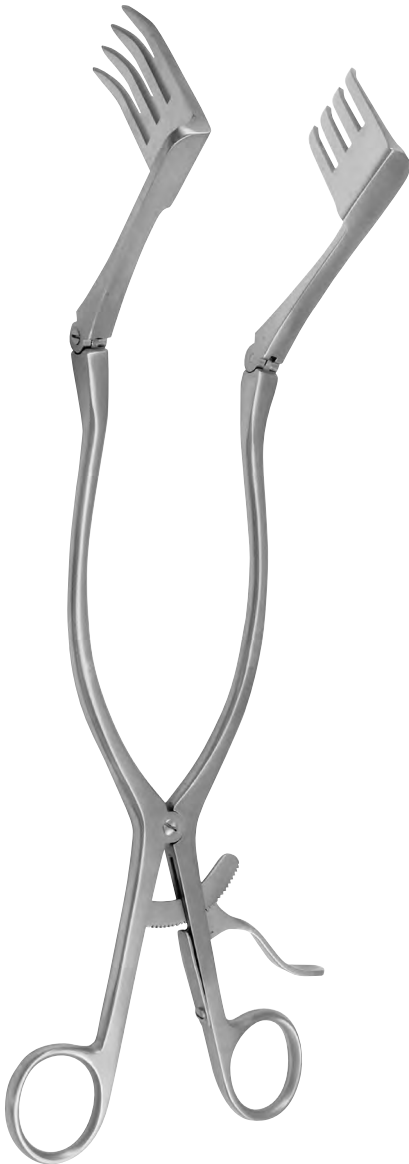
scharf  
sharp  
agudo  
acuto

4 x 4

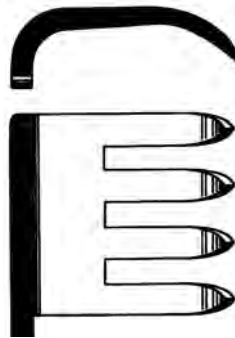


**16-260-02**

stumpf  
blunt  
romo  
smusso



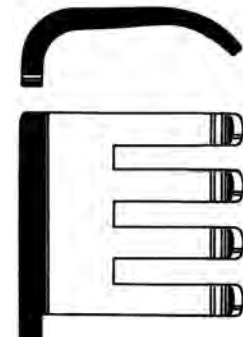
4 x 4



**16-259-01**

scharf  
sharp  
agudo  
acuto

4 x 4



**16-259-02**

stumpf  
blunt  
romo  
smusso

**BECKMANN-ADSON**

**16-259-01 - 16-260-02** 30,5 cm, 12 "





**16-261-28**

scharf  
sharp  
agudo  
acuto

**HARVEY-JACKSON**

**16-261-28** 28,0 cm, 11 "

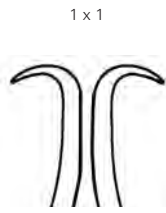


**16-261-32**

scharf  
sharp  
agudo  
acuto

**BECKMANN-EATON**

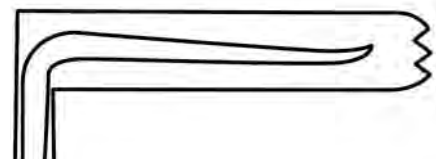
**16-261-32** 32,0 cm, 12 ½ "



**16-262-14**

**DE BAKAY**

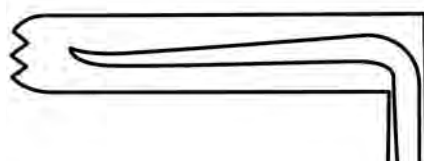
**16-262-14** 17,5 cm, 7"



<b>16-263-01</b>	50 x 10 mm
<b>16-263-02</b>	60 x 10 mm
<b>16-263-03</b>	70 x 10 mm
<b>16-263-04</b>	50 x 20 mm
<b>16-263-05</b>	60 x 20 mm
<b>16-263-06</b>	70 x 20 mm

**WILLIAMS**

**16-263-01 - 16-263-06** 17,0 cm, 6 3/4"



<b>16-264-01</b>	50 x 10 mm
<b>16-264-02</b>	60 x 10 mm
<b>16-264-03</b>	70 x 10 mm
<b>16-264-04</b>	50 x 20 mm
<b>16-264-05</b>	60 x 20 mm
<b>16-264-06</b>	70 x 20 mm

**WILLIAMS**

**16-264-01 - 16-264-06** 17,0 cm, 6 3/4"



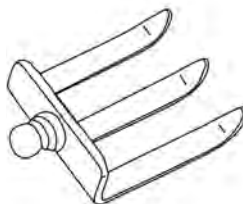
max. Spreizweite 210 mm  
max. spread 210 mm  
apertura máxima 210 mm  
apertura massima 210 mm

## ROBIN-MASSE

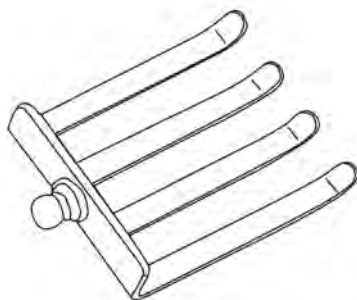
16-265-00



Seitenvalve 40 x 35 mm, halbscharf  
Lateral valve 40 x 35 mm, semi-sharp  
Valva laterales 40 x 35 mm, semi-agudo  
Valve laterali 40 x 35 mm, semi-acuto



Seitenvalve 60 x 50 mm, stumpf  
Lateral valve 60 x 50 mm, blunt  
Valvas laterale 60 x 50 mm, romo  
Valve laterali 60 x 50 mm, smusso



## POPLITEA

16-266-02 SET



## POPLITEA

16-266-00 SET



Komplett, bestehend aus:

1 Sperrer	<b>16-266-01</b>
1 Seitenvalven, paar	<b>16-266-02</b>

Complete, consisting of:

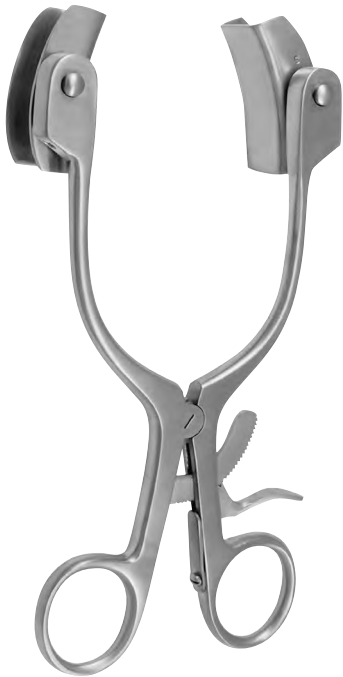
1 Retractor	<b>16-266-01</b>
1 Lateral valves, pair	<b>16-266-02</b>

Completo, compuesto de:

1 Separador	<b>16-266-01</b>
1 Valvas laterales, par	<b>16-266-02</b>

Completo, compuesto de:

1 Divaricatore	<b>16-266-01</b>
1 valve laterali, paio	<b>16-266-02</b>



max. Spreizweite 80 mm  
max. spread 80 mm  
apertura máxima 80 mm  
apertura massima 80 mm

Seitenvalven, paar, 18 x 40 | 27 x 40 mm  
Lateral valves, pair, 18 x 40 | 27 x 40 mm  
Valvas laterale, par, 18 x 40 | 27 x 40 mm  
Valve laterali, paio, 18 x 40 | 27 x 40 mm



max. Spreizweite 100 mm  
max. spread 100 mm  
apertura máxima 100 mm  
apertura massima 100 mm

Seitenvalve, 38 x 60 mm  
Lateral valves, 38 x 60 mm  
Valvas laterale, 38 x 60 mm  
Valve laterali, 38 x 60 mm

**BABY-COLLIN**

**16-267-00** 20,0 cm, 8"



**COLLIN**

**16-268-00** 24,0 cm, 9 1/2"



max. Spreizweite 100 mm  
max. spread 100 mm  
apertura máxima 100 mm  
apertura massima 100 mm

**COLLIN**

**16-270-00** 23,0 cm, 9"

komplett, bestehend aus:  
1 Sperrer mit Seitenvalven 38x60 mm  
1 Mittelvalve 38x55 mm

complete, consisting of:  
1 Spreader with lateral valves 38x60 mm  
1 Central valve 38x55 mm

completo, compuesto de:  
1 Separador con valvas laterales 38x60 mm  
1 Valva central 38x55 mm

completo, composto da:  
1 Divaricatore con valve laterali 38x60 mm  
1 Valva centrale 38x55 mm



**COLLIN**

**16-270-01** 23,0 cm, 9"

komplett, bestehend aus:  
1 Sperrer mit Seitenvalven 45x80 mm  
1 Mittelvalve 50x75 mm

complete, consisting of:  
1 Spreader with lateral valves 45x80 mm  
1 Central valve 50x75 mm

completo, compuesto de:  
1 Separador con valvas laterales 45x80 mm  
1 Valva central 50x75 mm

completo, composto da:  
1 Divaricatore con valve laterali 45x80 mm  
1 Valva centrale 50x75 mm

**COLLIN**

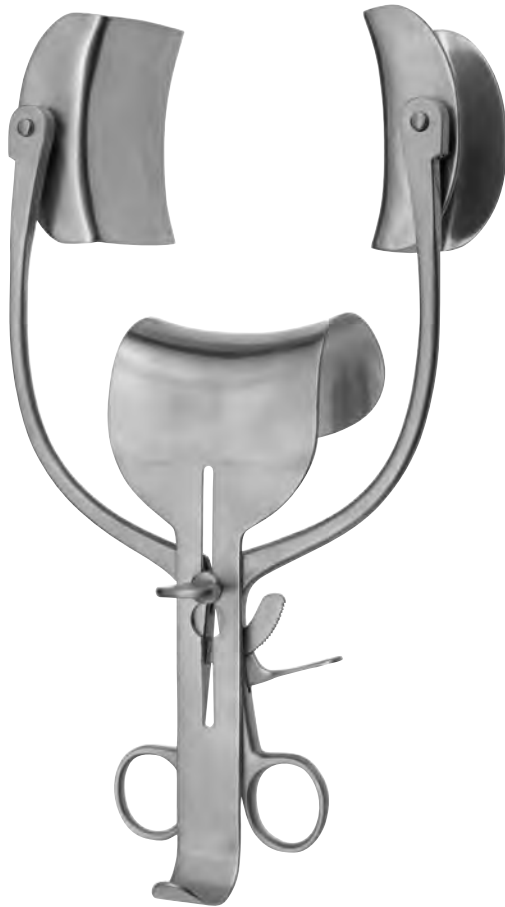
**16-270-02** 23,0 cm, 9"

komplett, bestehend aus:  
1 Sperrer mit Seitenvalven 37x98 mm  
1 Mittelvalve 52x76 mm

complete, consisting of:  
1 Spreader with lateral valves 37x98 mm  
1 Central valve 52x76 mm

completo, compuesto de:  
1 Separador con valvas laterales 37x98 mm  
1 Valva central 52x76 mm

completo, composto da:  
1 Divaricatore con valve laterali 37x98 mm  
1 Valva centrale 52x76 mm



max. Spreizweite 150 mm  
max. spread 150 mm  
apertura máxima 150 mm  
apertura massima 150 mm



### COLLIN-LOKTITE

**16-271-00** 31,0 cm, 12 1/4"

komplett, bestehend aus:  
1 Sperrer mit Seitenventilen 48x59 mm  
1 Mittelvalve 63x74 mm

complete, consisting of:  
1 Spreader with lateral valves 48x59 mm  
1 Central valve 63x74 mm

completo, compuesto de:  
1 Separador con valvas laterales 48x59 mm  
1 Valva central 63x74 mm

completo, composto da:  
1 Divaricatore con valve laterali 48x59 mm  
1 Valva centrale 63x74 mm

### COLLIN-LOKTITE

**16-271-01** 31,0 cm, 12 1/4"

komplett, bestehend aus:  
1 Sperrer mit Seitenventilen 60x80 mm  
1 Mittelvalve 60x75 mm

complete, consisting of:  
1 Spreader with lateral valves 60x80 mm  
1 Central valve 60x75 mm

completo, compuesto de:  
1 Separador con valvas laterales 60x80 mm  
1 Valva central 60x75 mm

completo, composto da:  
1 Divaricatore con valve laterali 60x80 mm  
1 Valva centrale 60x75 mm



Seitenventilen mit Kugelschnellverschluss, Paar  
Lateral valves with ball snap closure, pair  
Valvas laterales con cierre rápido esférico, par  
Valve laterali a chiusura istantanea, paio

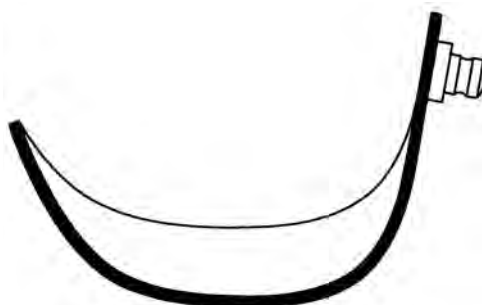


### COLLIN

<b>16-270-05</b>	37 x 98 mm
<b>16-270-07</b>	49 x 59 mm
<b>16-270-08</b>	61 x 80 mm



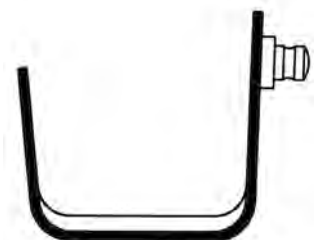
Seitenventilen mit Kugelschnellverschluss  
Lateral valves with ball snap closure  
Valvas laterales con cierre rápido esférico  
Valve laterali a chiusura istantanea



<b>16-273-50</b>	50 x 70 mm
<b>16-273-52</b>	52 x 110 mm
<b>16-273-70</b>	70 x 55 mm
<b>16-273-80</b>	75 x 90 mm
<b>16-273-90</b>	50 x 58 mm
<b>16-273-92</b>	60 x 80 mm
<b>16-273-94</b>	72 x 58 mm



Seitenventilen mit Kugelschnellverschluss  
Lateral valves with ball snap closure  
Valvas laterales con cierre rápido esférico  
Valve laterali a chiusura istantanea



<b>16-273-18</b>	18 x 40 mm
<b>16-273-27</b>	27 x 40 mm
<b>16-273-38</b>	38 x 60 mm
<b>16-273-40</b>	40 x 80 mm
<b>16-273-45</b>	45 x 80 mm
<b>16-273-60</b>	60 x 80 mm



max. Spreizweite 300 mm  
max. spread 300 mm  
apertura máxima 300 mm  
apertura massima 300 mm

max. Spreizweite 280 mm  
max. spread 280 mm  
apertura máxima 280 mm  
apertura massima 280 mm



**RICARD**

**16-272-00** 28,0 cm, 11 "

komplett, bestehend aus:  
1 Sperrer allein (16-272-01)  
1 Paar Seitenvalven 60 x 80 mm  
1 Mittelvalve 55 x 70 mm

complete, consisting of:  
1 Spreader only (16-272-01)  
1 Pair lateral valves 60 x 80 mm  
1 Central valve 55 x 70 mm

completo, compuesto de:  
1 Separador solo (16-272-01)  
1 Par valvas laterales 60 x 80 mm  
1 Valva central 55 x 70 mm

completo, composto da:  
1 Divaricatore solo (16-272-01)  
1 Paio valve laterali 60 x 80 mm  
1 Valva centrale 55 x 70 mm

**RICARD**

**16-273-00** 28,0 cm, 11 "

komplett, bestehend aus:  
1 Sperrer allein (16-272-01)  
1 Paar Seitenvalven 72 x 85 mm  
1 Mittelvalve 80 x 90 mm

complete, consisting of:  
1 Spreader only (16-272-01)  
1 Pair lateral valves 72 x 85 mm  
1 Central valve 80 x 90 mm

completo, compuesto de:  
1 Separador solo (16-272-01)  
1 Par valvas laterales 72 x 85 mm  
1 Valva central 80 x 90 mm

completo, composto da:  
1 Divaricatore solo (16-272-01)  
1 Paio valve laterali 72 x 85 mm  
1 Valva centrale 80 x 90 mm



Seitenvalven mit Kugelschnellverschluss, Paar  
Lateral valves with ball snap closure, pair  
Valvas laterales con cierre rápido esférico, par  
Valve laterali a chiusura istantanea, paio



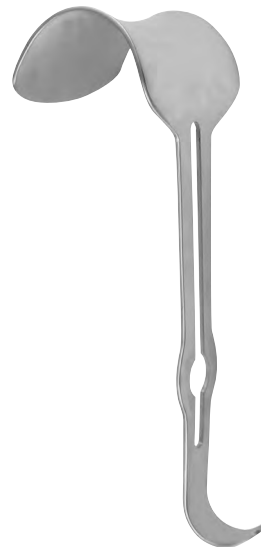
Mittelvalve mit Kugelschnellverschluss  
Central valve with ball snap closure  
Valvas central con cierre rápido esférico  
Valve centrale a chiusura istantanea



**RICARD**

**16-272-02** 60 x 80 mm

**16-272-03** 72 x 85 mm



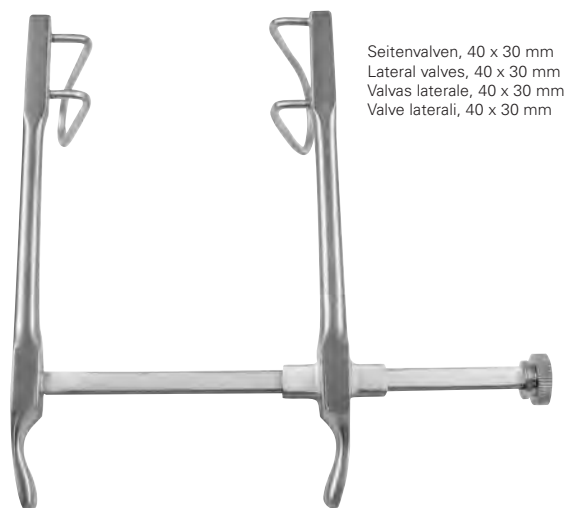
**RICARD**

**16-272-04** 55 x 70 mm

**16-272-05** 80 x 90 mm



max. Spreizweite 100 mm  
max. spread 100 mm  
apertura máxima 100 mm  
apertura massima 100 mm

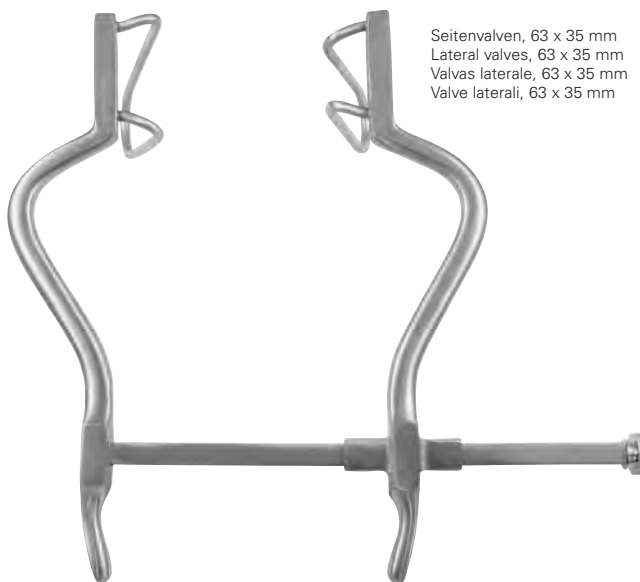


Seitenvalven, 40 x 30 mm  
Lateral valves, 40 x 30 mm  
Valvas laterale, 40 x 30 mm  
Valve laterali, 40 x 30 mm

### GOSSET-BABY

**16-274-10** 12,5 cm, 5"

max. Spreizweite 140 mm  
max. spread 140 mm  
apertura máxima 140 mm  
apertura massima 140 mm



Seitenvalven, 63 x 35 mm  
Lateral valves, 63 x 35 mm  
Valvas laterale, 63 x 35 mm  
Valve laterali, 63 x 35 mm

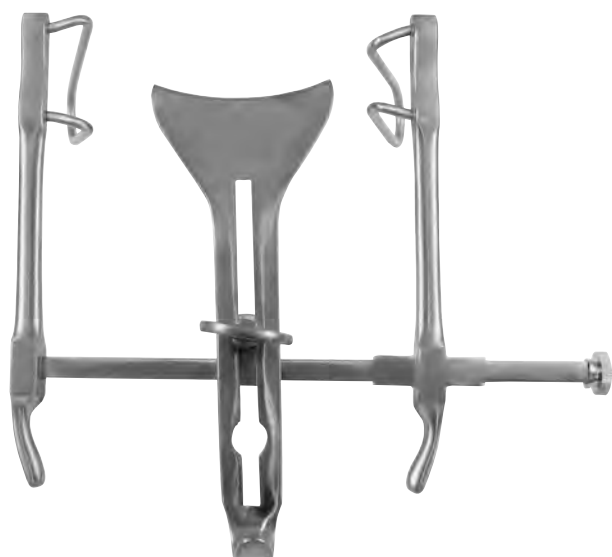
### GOSSET

**16-274-14** 18,5 cm, 7 1/4"

max. Spreizweite 160 mm  
max. spread 160 mm  
apertura máxima 160 mm  
apertura massima 160 mm

Seitenvalven, 63 x 35 mm  
Lateral valves, 63 x 35 mm  
Valvas laterale, 63 x 35 mm  
Valve laterali, 63 x 35 mm

Mittelvalve, 60 x 56 mm  
Central valve, 60 x 56 mm  
Valvas central, 60 x 56 mm  
Valve centrale, 60 x 56 mm

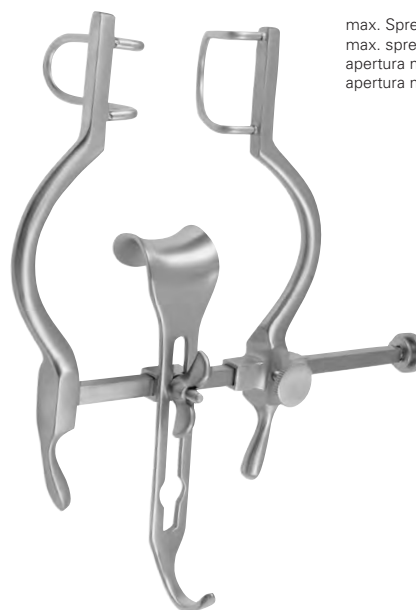


### GOSSET

**16-275-18** 16,5 cm, 6 1/2"

Seitenvalven, 27 x 27 mm  
Lateral valves, 27 x 27 mm  
Valvas laterale, 27 x 27 mm  
Valve laterali, 27 x 27 mm

Mittelvalve, 24 x 20 mm  
Central valve, 24 x 20 mm  
Valvas central, 24 x 20 mm  
Valve centrale, 24 x 20 mm



max. Spreizweite 90 mm  
max. spread 90 mm  
apertura máxima 90 mm  
apertura massima 90 mm

### BALFOUR-BABY

**16-276-00** 12,5 cm, 5"

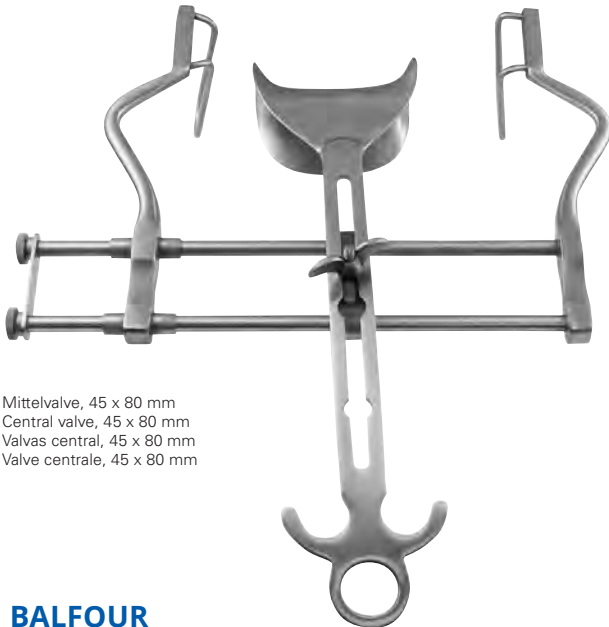


max. Spreizweite 180 mm  
max. spread 180 mm  
apertura máxima 180 mm  
apertura massima 180 mm

Seitenventile, 70 x 35 mm  
Lateral valves, 70 x 35 mm  
Valvas laterale, 70 x 35 mm  
Valve laterali, 70 x 35 mm

max. Spreizweite 200 mm  
max. spread 200 mm  
apertura máxima 200 mm  
apertura massima 200 mm

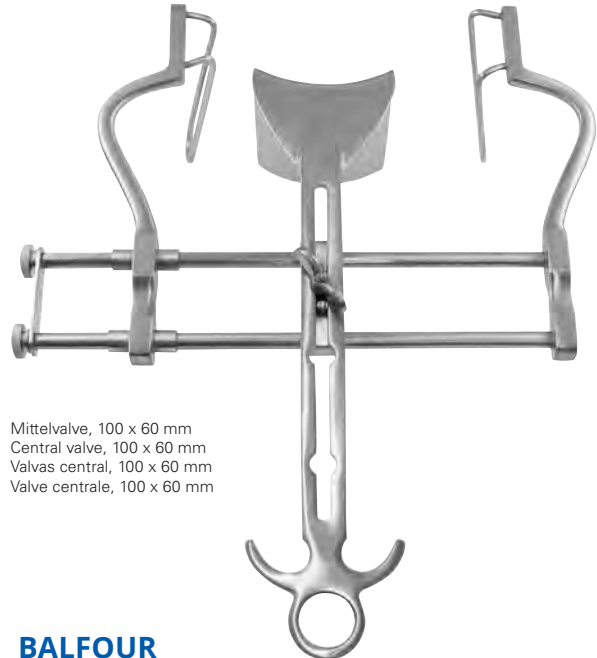
Seitenventile, 100 x 35 mm  
Lateral valves, 100 x 35 mm  
Valvas laterale, 100 x 35 mm  
Valve laterali, 100 x 35 mm



Mittelventil, 45 x 80 mm  
Central valve, 45 x 80 mm  
Valvas central, 45 x 80 mm  
Valve centrale, 45 x 80 mm

**BALFOUR**

**16-277-18** 20,0 cm, 8"



Mittelventil, 100 x 60 mm  
Central valve, 100 x 60 mm  
Valvas central, 100 x 60 mm  
Valve centrale, 100 x 60 mm

**BALFOUR**

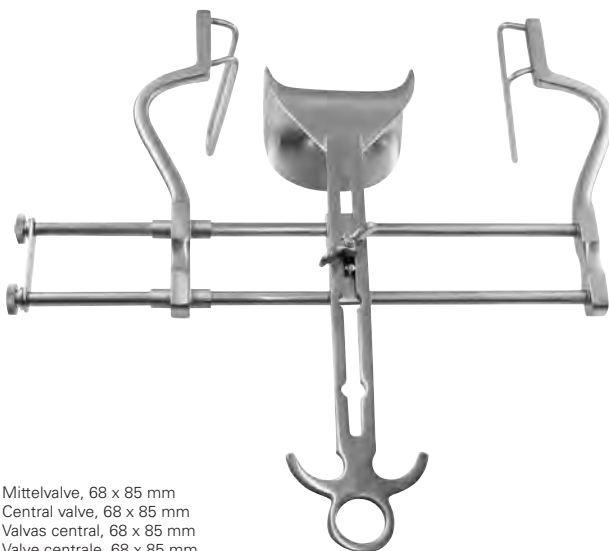
**16-277-20** 20,0 cm, 8"

max. Spreizweite 250 mm  
max. spread 250 mm  
apertura máxima 250 mm  
apertura massima 250 mm

Seitenventile, 100 x 35 mm  
Lateral valves, 100 x 35 mm  
Valvas laterale, 100 x 35 mm  
Valve laterali, 100 x 35 mm

Seitenventile, 70 x 35 mm  
Lateral valves, 70 x 35 mm  
Valvas laterale, 70 x 35 mm  
Valve laterali, 70 x 35 mm

max. Spreizweite 180 mm  
max. spread 180 mm  
apertura máxima 180 mm  
apertura massima 180 mm



Mittelventil, 68 x 85 mm  
Central valve, 68 x 85 mm  
Valvas central, 68 x 85 mm  
Valve centrale, 68 x 85 mm

**BALFOUR**

**16-277-25** 20,0 cm, 8"

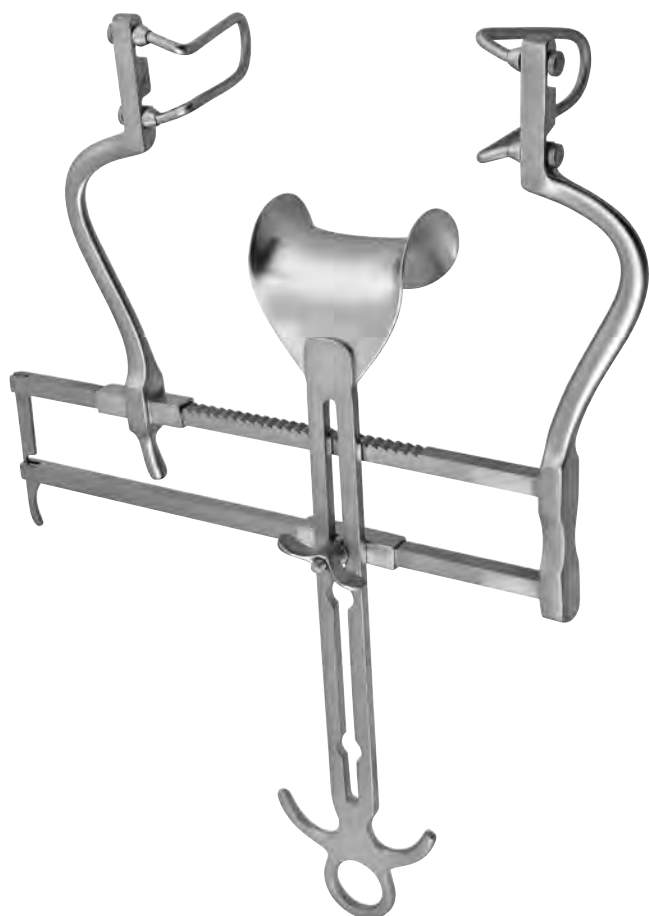


Mittelventil, 45 x 80 mm  
Central valve, 45 x 80 mm  
Valvas central, 45 x 80 mm  
Valve centrale, 45 x 80 mm

**BALFOUR**

**16-278-18** 20,0 cm, 8"





max. Spreizweite 250 mm  
max. spread 250 mm  
apertura máxima 250 mm  
apertura massima 250 mm

Drahtvalven, tief, Paar  
Fenestrated valves, deep, pair  
Valvas de alambre de profundidad, par  
Valve di fil profondità, paio



### BALFOUR USA

<b>16-279-10</b>	60,0 mm
<b>16-279-11</b>	80,0 mm

### BALFOUR USA

#### 16-279-00 Set

komplett, bestehend aus:

- 1 Sperrer
- 1 Drahtvalven 60 mm, Paar
- 1 Drahtvalven 80 mm, Paar

complete, consisting of:

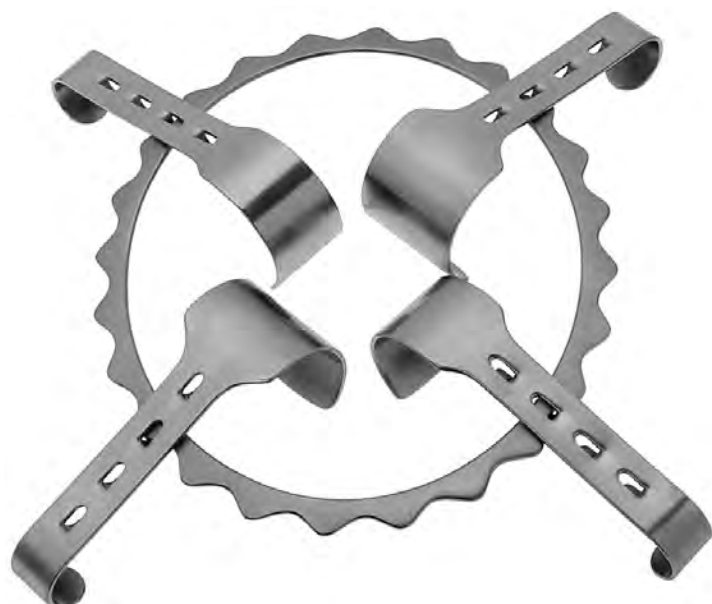
- 1 Spreader
- 1 Fenestrated valves 60 mm, pair
- 1 Fenestrated valves 80 mm, pair

completo, compuesto de:

- 1 Separador
- 1 Valvas de alambre 60 mm, par
- 1 Valvas de alambre 80 mm, par

completo, composto da:

- 1 Divaricatore
- 1 Valve di fil profondità 60 mm, paio
- 1 Valve di fil profondità 80 mm, paio



### DENNIS-BROWNE

<b>16-281-30</b>	20 x 30 mm
<b>16-281-32</b>	20 x 40 mm
<b>16-281-36</b>	40 x 30 mm
<b>16-281-40</b>	40 x 40 mm

Valven, allein  
Valves, only  
Valvas, solo  
Valve, suelto

### DENNIS-BROWNE

<b>16-281-15</b>	175 x 150 mm
<b>16-281-16</b>	225 x 180 mm

Rahmen, allein  
Frame, only  
Cuadro, solo  
Telaio, suelto

### DENNIS-BROWNE

#### 16-281-00 Set

komplett, bestehend aus:

- 1 Rahmen 175x150 mm (16-281-15)
- 2 Valven 40x30 mm (16-281-36)
- 2 Valven 40x40 mm (16-281-40)

complete, consisting of:

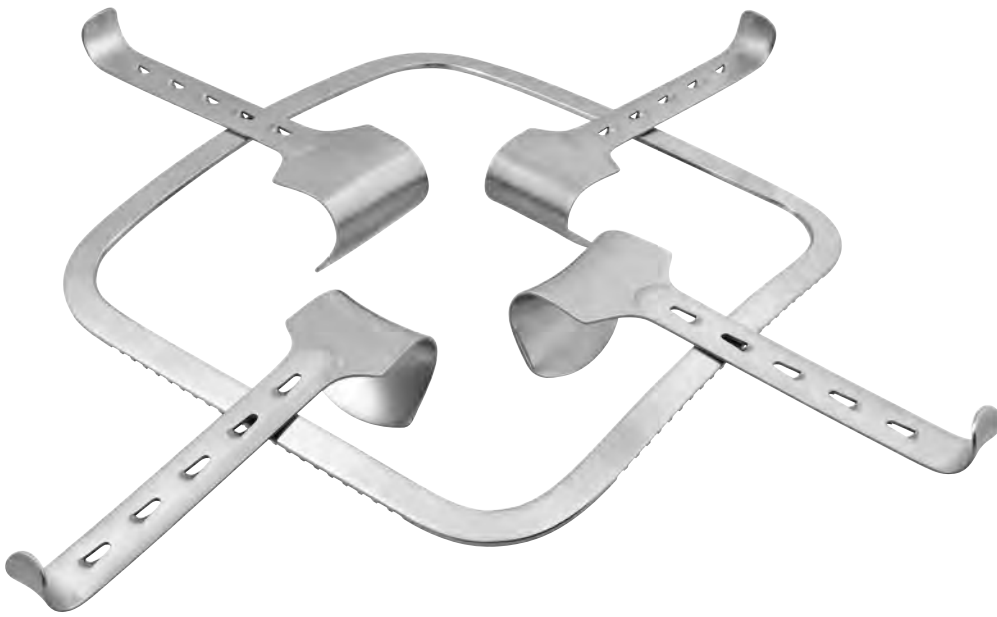
- 1 Frame 175x150 mm (16-281-15)
- 2 Valves 40x30 mm (16-281-36)
- 2 Valves 40x40 mm (16-281-40)

completo, compuesto de:

- 1 Cuadro 175x150 mm (16-281-15)
- 2 Valvas 40x30 mm (16-281-36)
- 2 Valvas 40x40 mm (16-281-40)

completo, composto da:

- 1 Telaio 175x150 mm (16-281-15)
- 2 Valve 40x30 mm (16-281-36)
- 2 Valve 40x40 mm (16-281-40)



**KIRSCHNER**

<b>16-283-24</b>	240 x 240 mm
<b>16-283-26</b>	295 x 275 mm
<b>16-283-27</b>	275 x 355 mm

Rahmen, allein  
Frame, only  
Cuadro, solo  
Telaio, suelto

**KIRSCHNER**

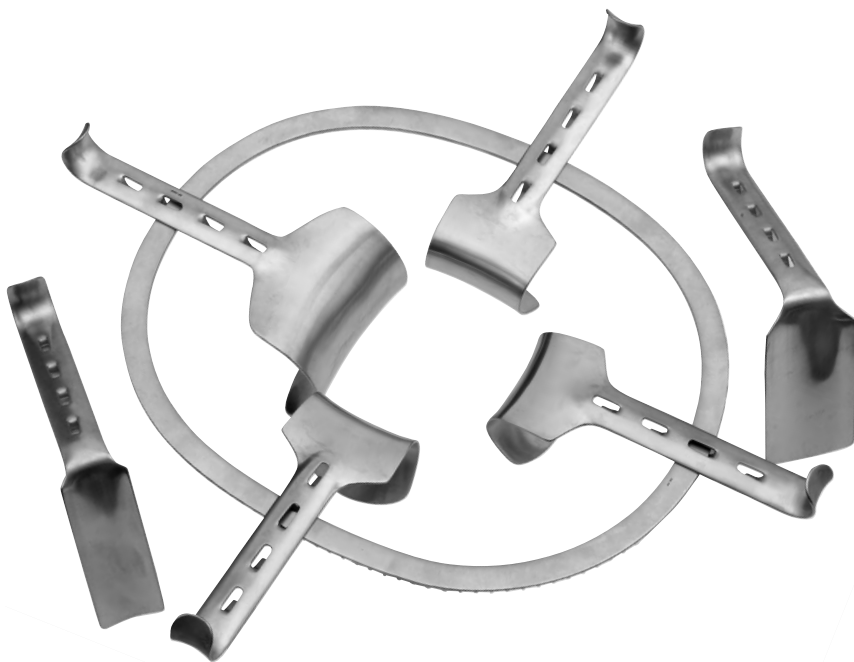
**16-283-00** Set

komplett, bestehend aus:  
1 Rahmen 240x240 mm (16-283-24)  
2 Valven 40x55 mm (16-283-40)  
2 Valven 50x65 mm (16-283-50)

complete, consisting of:  
1 Frame 240x240 mm (16-283-24)  
2 Valves 40x55 mm (16-283-40)  
2 Valves 50x65 mm (16-283-50)

completo, compuesto de:  
1 Cuadro 240x240 mm (16-283-24)  
2 Valvas 40x55 mm (16-283-40)  
2 Valvas 50x65 mm (16-283-50)

completo, composto da:  
1 Telaio 240x240 mm (16-283-24)  
2 Valve 40x55 mm (16-283-40)  
2 Valve 50x65 mm (16-283-50)



**KIRSCHNER**

<b>16-284-30</b>	340 x 240 mm
------------------	--------------

Rahmen, allein  
Frame, only  
Cuadro, solo  
Telaio, suelto

**KIRSCHNER**

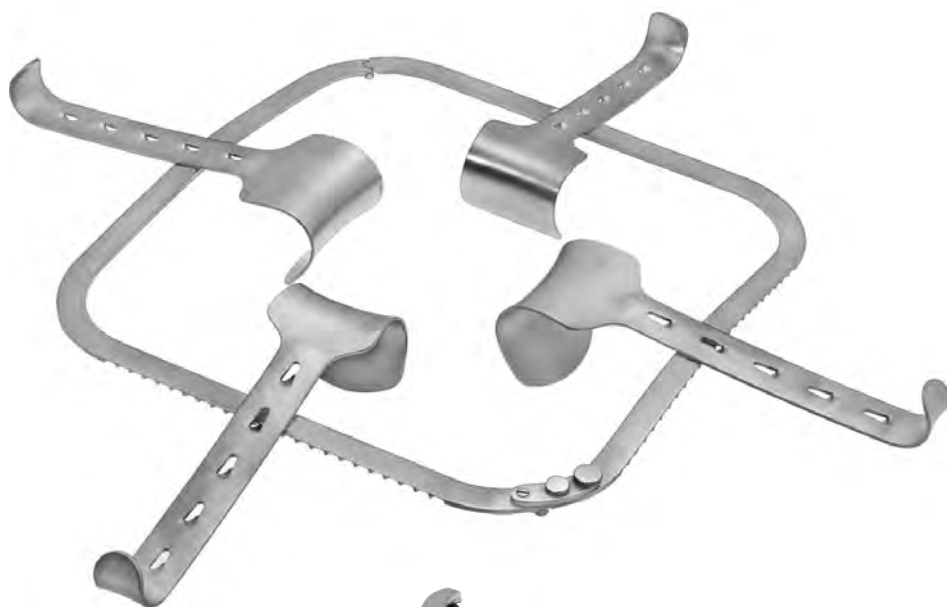
**16-284-00** Set

komplett, bestehend aus:  
1 Rahmen 340x240 mm (16-284-30)  
3 Valven 50x65 mm (16-283-50)  
1 Valve 80x90 mm (16-283-80)  
1 Valve 98x50 mm (16-283-98)  
1 Valve 105x35 mm (16-283-99)

complete, consisting of:  
1 Frame 340x240 mm (16-284-30)  
3 Valves 50x65 mm (16-283-50)  
1 Valve 80x90 mm (16-283-80)  
1 Valve 98x50 mm (16-283-98)  
1 Valve 105x35 mm (16-283-99)

completo, compuesto de:  
1 Cuadro 340x240 mm (16-284-30)  
3 Valvas 50x65 mm (16-283-50)  
1 Valva 80x90 mm (16-283-80)  
1 Valva 98x50 mm (16-283-98)  
1 Valva 105x35 mm (16-283-99)

completo, composto da:  
1 Telaio 340x240 mm (16-284-30)  
3 Valve 50x65 mm (16-283-50)  
1 Valva 80x90 mm (16-283-80)  
1 Valva 98x50 mm (16-283-98)  
1 Valva 105x35 mm (16-283-99)



## KIRSCHNER

### 16-285-00 Set

komplett, bestehend aus:  
 1 Rahmen 240x240 mm (16-283-28)  
 2 Valven 40x55 mm (16-283-40)  
 2 Valven 50x65 mm (16-283-50)

complete, consisting of:  
 1 Frame 240x240 mm (16-283-28)  
 2 Valves 40x55 mm (16-283-40)  
 2 Valves 50x65 mm (16-283-50)

completo, compuesto de:  
 1 Cuadro 240x240 mm (16-283-28)  
 2 Valvas 40x55 mm (16-283-40)  
 2 Valvas 50x65 mm (16-283-50)

completo, composto da:  
 1 Telaio 240x240 mm (16-283-28)  
 2 Valve 40x55 mm (16-283-40)  
 2 Valve 50x65 mm (16-283-50)

## KIRSCHNER

<b>16-283-28</b>	240 x 240 mm
<b>16-283-29</b>	350 x 350 mm
<b>16-283-30</b>	430 x 430 mm

Rahmen, allein  
 Frame, only  
 Cuadro, solo  
 Telaio, suelto



## KIRSCHNER

<b>16-283-40</b>	40 x 55 mm
<b>16-283-50</b>	50 x 65 mm
<b>16-283-78</b>	78 x 65 mm
<b>16-283-80</b>	80 x 90 mm



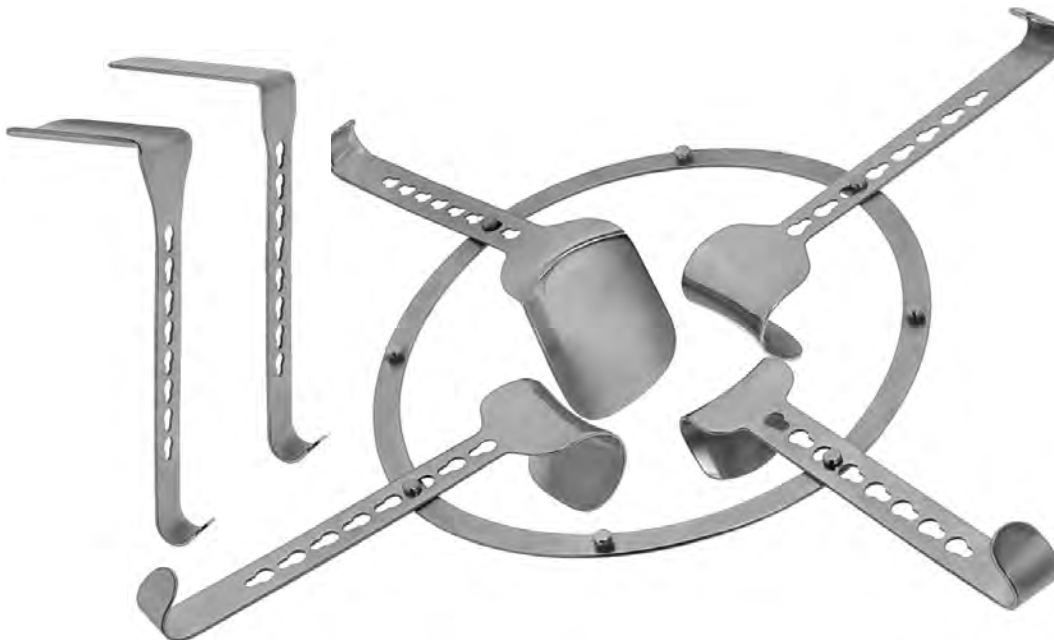
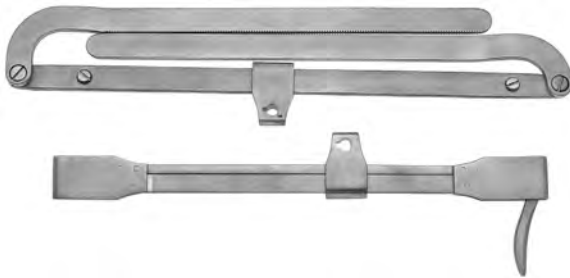
## KIRSCHNER

<b>16-283-60</b>	60 x 85 mm
------------------	------------



## KIRSCHNER

<b>16-283-98</b>	98 x 50 mm
<b>16-283-99</b>	105 x 35 mm



## SEMM

**16-290-09** 255 x 220 mm

Rahmen, allein  
Frame, only  
Cuadro, solo  
Telaio, suelto

## FRANZ

**16-286-00** Set

komplett, bestehend aus:  
1 Rahmen 300x300 mm  
2 Valven 38x60 mm  
2 Valven 50x65 mm

complete, consisting of:  
1 Frame 300x300 mm  
2 Valves 38x60 mm  
2 Valves 50x65 mm

completo, compuesto de:  
1 Cuadro 300x300 mm  
2 Valvas 38x60 mm  
2 Valvas 50x65 mm

completo, composto da:  
1 Telaio 300x300 mm  
2 Valve 38x60 mm  
2 Valve 50x65 mm

## SEMM

**16-290-00** Set

komplett, bestehend aus:  
1 Rahmen 255x220 mm (16-290-09)  
2 Valven 46x64 mm (16-290-01)  
1 Valve 53x54 mm (16-290-02)  
1 Valve 82x97 mm (16-290-03)  
1 Valve 96x51 mm (16-290-04)  
1 Valve 107x36 mm (16-290-05)

complete, consisting of:  
1 Frame 255x220 mm (16-290-09)  
2 Valves 46x64 mm (16-290-01)  
1 Valve 53x54 mm (16-290-02)  
1 Valve 82x97 mm (16-290-03)  
1 Valve 96x51 mm (16-290-04)  
1 Valve 107x36 mm (16-290-05)

completo, compuesto de:  
1 Cuadro 255x220 mm (16-290-09)  
2 Valvas 46x64 mm (16-290-01)  
1 Valva 53x54 mm (16-290-02)  
1 Valva 82x97 mm (16-290-03)  
1 Valva 96x51 mm (16-290-04)  
1 Valva 107x36 mm (16-290-05)

completo, composto da:  
1 Telaio 255x220 mm (16-290-09)  
2 Valve 46x64 mm (16-290-01)  
1 Valva 53x54 mm (16-290-02)  
1 Valva 82x97 mm (16-290-03)  
1 Valva 96x51 mm (16-290-04)  
1 Valva 107x36 mm (16-290-05)



## CHARNLEY

**16-293-00** Set

komplett, bestehend aus:  
1 Rahmen 320x230 mm  
2 Valven

complete, consisting of:  
1 Frame 320x230 mm  
2 Valves

completo, compuesto de:  
1 Cuadro 320x230 mm  
2 Valvas

completo, composto da:  
1 Telaio 320x230 mm  
2 Valve

## CHARNLEY

**16-293-10** 320 x 230 mm

Rahmen, allein  
Frame, only  
Cuadro, solo  
Telaio, suelto



## HOLZBACH

**16-295-00** SET

komplett, bestehend aus:  
1 Sperrer allein (16-295-05)  
1 Paar Seitenvalven 59 x 80 mm (16-295-02)  
1 Mittelvalve 74 x 82 mm (16-295-01)

complete, consisting of:  
1 Spreader only (16-295-05)  
1 Pair lateral valves 59 x 80 mm (16-295-02)  
1 Central valve 74 x 82 mm (16-295-01)

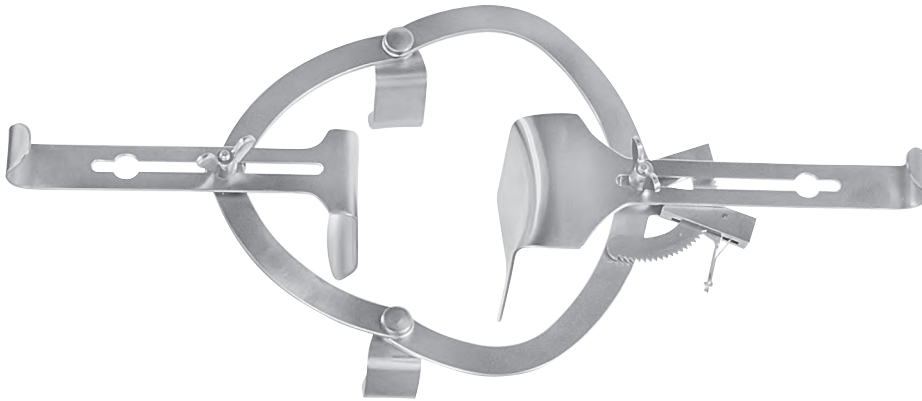
completo, compuesto de:  
1 Separador solo (16-295-05)  
1 Par valvas laterales 59 x 80 mm (16-295-02)  
1 Valva central 74 x 82 mm (16-295-01)

completo, composto da:  
1 Divaricatore solo (16-295-05)  
1 Paio valve laterali 59 x 80 mm (16-295-02)  
1 Valva centrale 74 x 82 mm (16-295-01)

## HOLZBACH

**16-295-05**

Sperrer, allein  
Spreader, only  
Separador, solo  
Divaricatore, solo



**O'SULLIVAN-O'CONNOR**

**16-296-00 SET**

komplett, bestehend aus:  
1 Rahmen mit 2 Seitenventilen 60x25 mm  
1 Valve 80x45 mm  
1 Valve 110x70 mm

complete, consisting of:  
1 Frame with 2 lateral valves 60x25 mm  
1 Valve 80x45 mm  
1 Valve 110x70 mm

completo, compuesto de:  
1 Cuadro con 2 valvas laterales 60x25 mm  
1 Valva 80x45 mm  
1 Valva 110x70 mm

completo, composto da:  
1 Telaio con 2 valve laterali 60x25 mm  
1 Valve 80x45 mm  
1 Valve 110x70 mm



**16-298-00 SET**

komplett, bestehend aus:  
1 Rahmen Ø 255 mm (16-298-25)  
4 Valven 50x65 mm (16-298-05)

complete, consisting of:  
1 Frame Ø 255 mm(16-298-25)  
4 Valves 50x65 mm(16-298-05)

completo, compuesto de:  
1 Cuadro Ø 255 mm (16-298-25)  
4 Valvas 50x65 mm(16-298-05)

completo, composto da:  
1 Telaio Ø 255 mm(16-298-25)  
4 Valve 50x65 mm(16-298-05)

**16-298-25** Ø 255 mm

Rahmen, allein  
Frame, only  
Cuadro, solo  
Telaio, suelto



**16-298-98** M 6

Ersatzknopf, allein  
Spare button, only  
Botón de repuesto, solo  
Bottone di ricambio, suelto



**16-298-05** 50 x 65 mm

**16-298-07** 75 x 65 mm

Valven, allein  
Valves, only  
Valvas, solo  
Valve, suelto







**ROCHARD**

**16-300-01** 660 x 530 mm



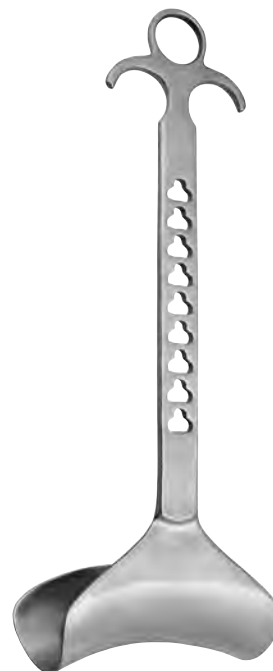
**ROCHARD**

**16-300-02** 660 x 530 mm



**ROCHARD**

**16-300-05** 19,5 cm, 7 3/4"



**ROCHARD**

**16-300-09** 50 x 90 mm

**16-300-10** 50 x 105 mm

**16-300-12** 50 x 120 mm

**16-300-13** 50 x 135 mm

**16-300-15** 50 x 155 mm



ohne Universalkloben  
without universal clamp  
sin soporte universal  
senza supporto universal

### 16-310-00 SET

Arm-System, bestehend aus:  
1 L -Stativ 470 x 170 mm, Radius 310 mm  
1 Universale Wundhakenhalterung (16-322-01)

Arm system, consisting of:  
1 L -stand 470 x 170 mm, radius 310 mm  
1 Universal retractor holder (16-322-01)

Sistema brazo, compuesto de:  
1 L -trípode 470 x 170 mm, radio 310 mm  
1 Separadores soporte universal (16-322-01)

Sistema braccio, composto da:  
1 L -stativo 470 x 170 mm, raggio 310 mm  
1 Supporto per divaricatori universal (16-322-01)



ohne Universalkloben  
without universal clamp  
sin soporte universal  
senza supporto universal

### 16-314-00 SET

Arm-System, bestehend aus:  
1 Geradem Stativ 300 mm, Radius 400 mm  
1 Universale Endoskophalterung (16-322-02)

Arm system, consisting of:  
1 Straight stand 300 mm, radius 400 mm  
1 Universal endoscope holder (16-322-02)

Sistema brazo, compuesto de:  
1 Tripode recto 300 mm, radio 400 mm  
1 Universal endoscopia soporte (16-322-02)

Sistema braccio, composto da:  
1 Stativo retto 300 mm, raggio 400 mm  
1 Universal supporto per endoscopio (16-322-02)





Universalkloben, Spannweite 50 mm,  
isoliert bis 4,5 kV  
Universal clamp, holding width 50 mm,  
insulated up to 4,5 kV  
Soporte universal, extensión 50 mm,  
aislado hasta 4,5 kV  
Supporto universal, apertura 50 mm,  
isolato fino a 4,5 kV

Universalkloben, Spannweite 50 mm  
Universal clamp, holding width 50 mm  
Soporte universal, extensión 50 mm  
Supporto universal apertura 50 mm



**16-320-00** Ø 16,0 mm

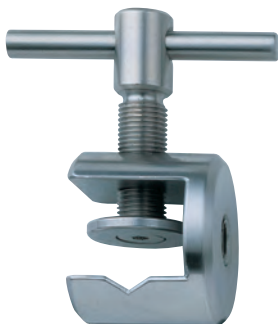


**16-321-00** Ø 16,0 mm



Universale Wundhakenhalterung  
Universal retractor holder  
Separadores soporte universal  
Supporto per divaricatori universal

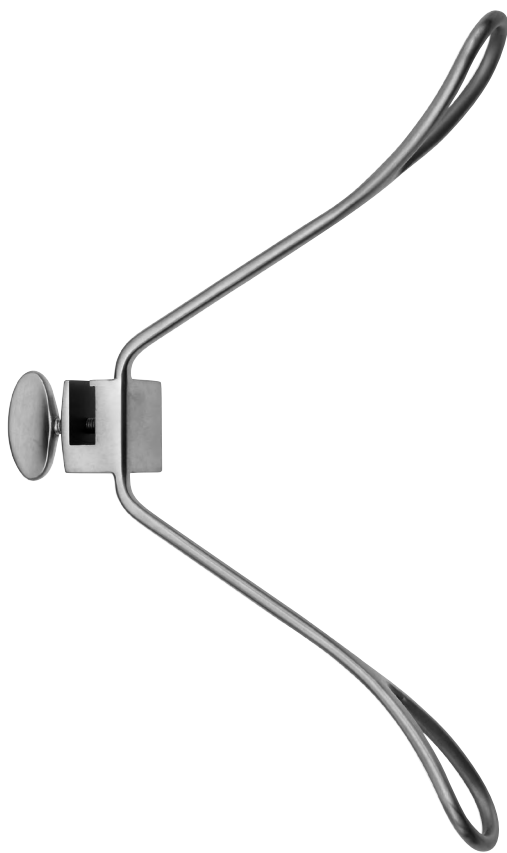
Universale Endoskophalterung  
Universal endoscope holder  
Universal endoscopio soporte  
Universal supporto per endoscopio



**16-322-01**



**16-322-02** Ø 2,7-4,0 mm



**DOYEN-CHILD**

**16-330-00** 22,5 cm, 8 <sup>3</sup>/<sub>4</sub> "



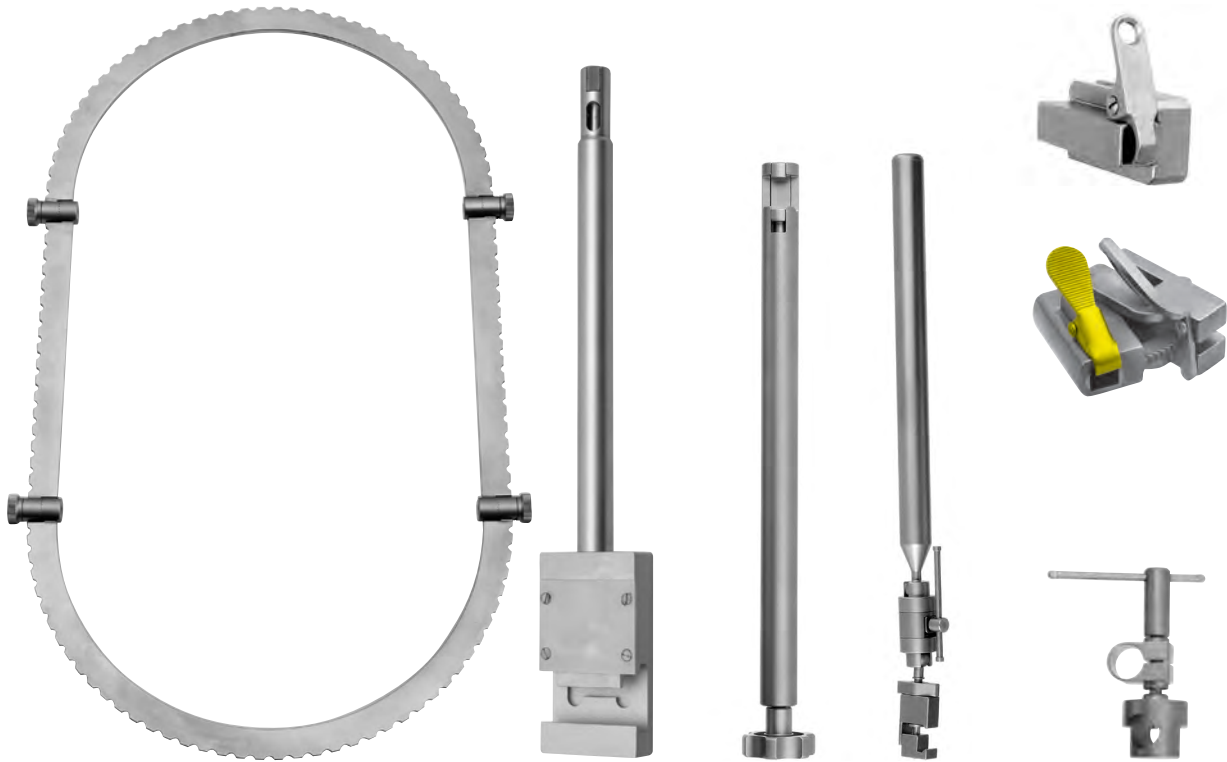
**DOYEN**

**16-330-01** 55 x 95 mm

**16-330-02** 55 x 105 mm

**16-330-03** 55 x 115 mm

**16-330-04** 55 x 125 mm



## 16-500-00 SET

Abdominal KIT II, bestehend aus:

- 1 Tischstativ (16-501-01)
- 1 Spanngelenk für 2 x 25 mm Rohre (16-501-02)
- 1 Rahmenhalter Ø 25 mm, Länge 36,5 cm (16-501-03)
- 1 Flexibler Haltearm, 360° drehbar (16-501-04)
- 2 Standard Fixierschlitten, 4 cm (16-501-06)
- 6 Tiltschlitten mit Verstellmechanismus (16-501-07)
- 1 Ovalrahmen, medium, 267 x 368 mm (16-502-02)
- 1 Rundrahmen, medium 266 x 495 mm (16-505-02)
- 1 BALFOUR Wundhaken 67 x 76 mm (16-510-01)
- 1 GELPI Wundhaken, mit Dorn (16-512-01)
- 1 HARRINGTON Wundhaken 63 x 143 mm (16-513-01)
- 2 KELLY Wundhaken, 51 x 76 mm (16-515-04)
- 1 KELLY Wundhaken, 51 x 101 mm (16-515-05)
- 1 KELLY Wundhaken, 51 x 127 mm (16-515-06)
- 1 KELLY Wundhaken, 51 x 152 mm (16-515-07)
- 1 Wundhaken, biegsam, 38 x 152 mm (16-516-01)
- 2 Wundhaken, biegsam, 51 x 152 mm (16-516-02)
- 1 Wundhaken, biegsam, 76 x 152 mm (16-516-03)

Abdominal KIT II, compuesto de:

- 1 Fijación de mesa (16-501-01)
- 1 Acoplamiento 25 mm (16-501-02)
- 1 Barra horizontal Ø 25 mm, 36,5 cm (16-501-03)
- 1 Barra horizontal con articulación esférica, 360° (16-501-04)
- 2 Soporte para separador, 4 cm (16-501-06)
- 6 Soporte para separador, inclinable, 4 cm (16-501-07)
- 1 Cerco, oval, medio, 267 x 368 mm (16-502-02)
- 1 Cerco, redondo, medio 266 x 495 mm (16-505-02)
- 1 BALFOUR separador 67 x 76 mm (16-510-01)
- 1 GELPI separador, con pincho (16-512-01)
- 1 HARRINGTON separador 63 x 143 mm (16-513-01)
- 2 KELLY separador, 51 x 76 mm (16-515-04)
- 1 KELLY separador, 51 x 101 mm (16-515-05)
- 1 KELLY separador, 51 x 127 mm (16-515-06)
- 1 KELLY separador, 51 x 152 mm (16-515-07)
- 1 Separador, maleables, 38 x 152 mm (16-516-01)
- 2 Separador, maleables, 51 x 152 mm (16-516-02)
- 1 Separador, maleables, 76 x 152 mm (16-516-03)

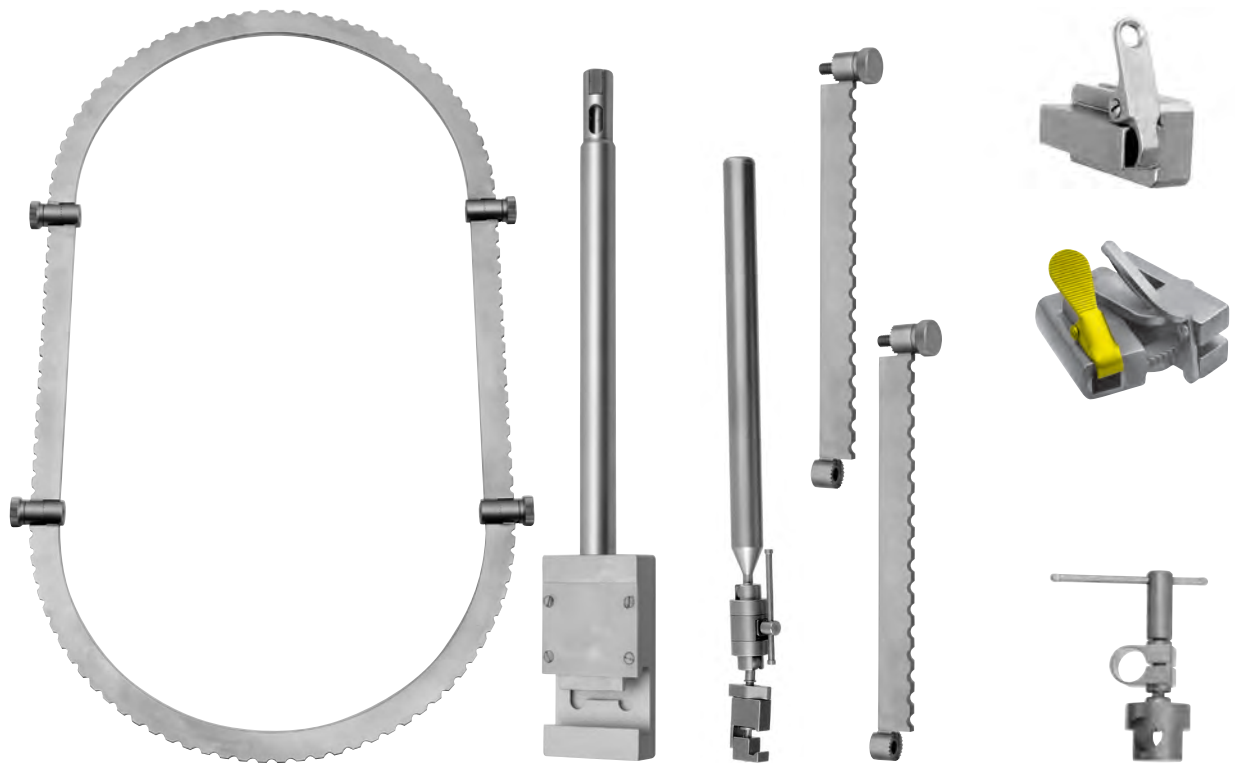
Abdominal KIT II, consisting of:

- 1 Table post (16-501-01)
- 1 Post coupling for 2 x 25 mm bars (16-501-02)
- 1 Horizontal bar Ø 25 mm, length 36,5 cm (16-501-03)
- 1 Horizontal flex bar, 360° rotatable (16-501-04)
- 2 Ratchet mechanisms, 4 cm (16-501-06)
- 6 Tilt ratchet mechanisms (16-501-07)
- 1 Oval ring, medium, 267 x 368 mm (16-502-02)
- 1 Segmented ring, medium 266 x 495 mm (16-505-02)
- 1 BALFOUR retractor 67 x 76 mm (16-510-01)
- 1 GELPI retractor, with pin (16-512-01)
- 1 HARRINGTON retractor 63 x 143 mm (16-513-01)
- 2 KELLY retractor, 51 x 76 mm (16-515-04)
- 1 KELLY retractor, 51 x 101 mm (16-515-05)
- 1 KELLY retractor, 51 x 127 mm (16-515-06)
- 1 KELLY retractor, 51 x 152 mm (16-515-07)
- 1 Retractor, malleable, 38 x 152 mm (16-516-01)
- 2 Retractors, malleable, 51 x 152 mm (16-516-02)
- 1 Retractor, malleable, 76 x 152 mm (16-516-03)

Abdominal KIT II, composto da:

- 1 Fissaggio per tavola (16-501-01)
- 1 Aggancio 25 mm (16-501-02)
- 1 Asta orizzontale Ø 25 mm, 36,5 cm (16-501-03)
- 1 Asta orizzontale con articolazione sferica, 360° (16-501-04)
- 2 Supporto per divaricatore, 4 cm (16-501-06)
- 6 Supporto per divaricatore, inclinabile, 4 cm (16-501-07)
- 1 Cornice, ovale, medio, 267 x 368 mm (16-502-02)
- 1 Cornice, tondo, medio 266 x 495 mm (16-505-02)
- 1 BALFOUR divaricatore 67 x 76 mm (16-510-01)
- 1 GELPI divaricatore, con spina (16-512-01)
- 1 HARRINGTON divaricatore 63 x 143 mm (16-513-01)
- 2 KELLY divaricatore, 51 x 76 mm (16-515-04)
- 1 KELLY divaricatore, 51 x 101 mm (16-515-05)
- 1 KELLY divaricatore, 51 x 127 mm (16-515-06)
- 1 KELLY divaricatore, 51 x 152 mm (16-515-07)
- 1 Divaricatore, melleabili, 38 x 152 mm (16-516-01)
- 2 Divaricatore, melleabili, 51 x 152 mm (16-516-02)
- 1 Divaricatore, melleabili, 76 x 152 mm (16-516-03)





## 16-500-01 SET

Wirbelsäulen KIT, bestehend aus:

- 1 Tischstativ (16-501-01)
- 1 Spanngelenk für 2 x 25 mm Röhre (16-501-02)
- 1 Flexibler Haltearm, 360° drehbar (16-501-04)
- 6 Standard Fixierschlitten, 4 cm (16-501-06)
- 4 Tiltschlitten mit Verstellmechanismus (16-501-07)
- 1 Rundrahmen, klein 216 x 356 mm (16-505-01)
- 2 Paar Segment, gerade 102 mm (16-506-10)
- 2 Paar Segment, gerade 152 mm (16-506-15)
- 2 Paar Segment, gerade 203 mm (16-506-20)
- 2 SCOVILLE Haken, klein, 50 mm (16-520-01)
- 2 SCOVILLE Haken, groß, 83 mm (16-520-02)
- 2 MEYERDING Wundhaken, 60 x 17 mm (16-517-01)
- 2 MEYERDING Wundhaken, 85 x 25 mm (16-517-02)
- 2 MEYERDING Wundhaken, 95 x 50 mm (16-517-03)
- 2 RAKE Wundhaken, 3-Zinker 19 x 17 mm (16-518-01)
- 2 RAKE Wundhaken, 4-Zinker 8,4 x 19 mm (16-518-02)
- 2 RAKE Wundhaken, 6-Zinker 8,4 x 25 mm (16-518-03)

Columna vertebral KIT, compuesto de:

- 1 Fijación de mesa (16-501-01)
- 1 Acoplamiento 25 mm (16-501-02)
- 1 Barra horizontal con articulación esférica, 360° (16-501-04)
- 6 Soporte para separador, 4 cm (16-501-06)
- 4 Soporte para separador, inclinable, 4 cm (16-501-07)
- 1 Cerco, redondo, pequeño 216 x 356 mm (16-505-01)
- 2 Segmento, derecha 102 mm (16-506-10)
- 2 Segmento, derecha 152 mm (16-506-15)
- 2 Segmento, derecha 203 mm (16-506-20)
- 2 SCOVILLE gancho, 50 mm (16-520-01)
- 2 SCOVILLE gancho, 83 mm (16-520-02)
- 2 MEYERDING separador, 60 x 17 mm (16-517-01)
- 2 MEYERDING separador, 85 x 25 mm (16-517-02)
- 2 MEYERDING separador, 95 x 50 mm (16-517-03)
- 2 RAKE separador, 3 pincho 19 x 17 mm (16-518-01)
- 2 RAKE separador, 4 pincho 8,4 x 19 mm (16-518-02)
- 2 RAKE separador, 6 pincho 8,4 x 25 mm (16-518-03)

Spinal KIT consisting of:

- 1 Table post (16-501-01)
- 1 Post coupling for 2 x 25 mm bars (16-501-02)
- 1 Horizontal flex bar, 360° rotatable (16-501-04)
- 6 Ratchet mechanisms, 4 cm (16-501-06)
- 4 Tilting ratchet mechanism (16-501-07)
- 1 Segmented ring, small 216 x 356 mm (16-505-01)
- 2 Pair ring segment straight, 102 mm (16-506-10)
- 2 Pair ring segment straight, 152 mm (16-506-15)
- 2 Pair ring segment straight, 203 mm (16-506-20)
- 2 SCOVILLE hooks, small, 50 mm (16-520-01)
- 2 SCOVILLE hooks, large, 83 mm (16-520-02)
- 2 MEYERDING retractors, 60 x 17 mm (16-517-01)
- 2 MEYERDING retractors, 85 x 25 mm (16-517-02)
- 2 MEYERDING retractors, 95 x 50 mm (16-517-03)
- 2 RAKE retractors, 19 x 17 mm (16-518-01)
- 2 RAKE retractors, 8,4 x 19 mm (16-518-02)
- 2 RAKE retractors, 8,4 x 25 mm (16-518-03)

Colonna vertebrale KIT, bestehend aus:

- 1 Fissaggio per tavola (16-501-01)
- 1 Aggancio 25 mm (16-501-02)
- 1 Asta orizzontale con articolazione sferica, 360° (16-501-04)
- 6 Supporto per divaricatore, 4 cm (16-501-06)
- 4 Supporto per divaricatore, inclinabile, 4 cm (16-501-07)
- 1 Cornice, tondo, piccolo 216 x 356 mm (16-505-01)
- 2 Segmento, retto 102 mm (16-506-10)
- 2 Segmento, retto 152 mm (16-506-15)
- 2 Segmento, retto 203 mm (16-506-20)
- 2 SCOVILLE uncini, 50 mm (16-520-01)
- 2 SCOVILLE uncini, 83 mm (16-520-02)
- 2 MEYERDING divaricatore, 60 x 17 mm (16-517-01)
- 2 MEYERDING divaricatore, 85 x 25 mm (16-517-02)
- 2 MEYERDING divaricatore, 95 x 50 mm (16-517-03)
- 2 RAKE divaricatore, 3 spina 19 x 17 mm (16-518-01)
- 2 RAKE divaricatore, 4 spina 8,4 x 19 mm (16-518-02)
- 2 RAKE divaricatore, 6 spina 8,4 x 25 mm (16-518-03)



Bauchdeckenhalter  
Abdominal retractors  
Separadores abdominales  
Divaricatori addominali



Tischstativ  
Table post  
Fijación de mesa  
Fissaggio per tavola



**16-501-01** 25,0 mm

Spanngelenk  
Post coupling  
Acoplamiento  
Aggancio



**16-501-02** 2 x 25,0 mm

Rahmenhalter Ø 25 mm  
Horizontal bar Ø 25 mm  
Barra horizontal Ø 25 mm  
Asta orizzontale Ø 25 mm



**16-501-03** 36,5 cm, 14 1/3"

Flexibler Haltearm, 360° drehbar  
Horizontal flex bar, 360° rotatable  
Barra horizontal con articulación  
esférica, 360°  
Asta orizzontale con articolazione  
sférica, 360°



**16-501-04**

Verlängerung  
Extension bar  
Alargamiento  
Prolungamento



**16-501-05** 30,5 cm, 12"

Standard Fixierschlitten  
Standard ratchet mechanism  
Soporte para separador  
Supporto per divaricatore

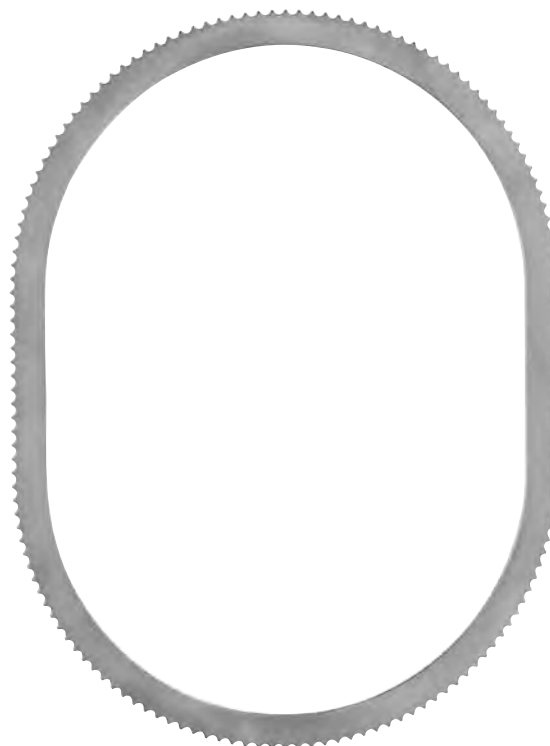


**16-501-06** 4,0 cm, 1 1/2"

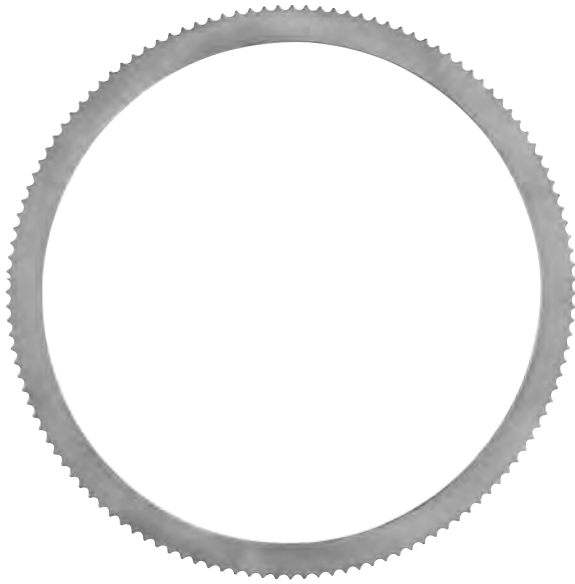
Tiltschlitten mit Verstellmechanismus  
Tilting ratchet mechanism  
Soporte para separador, inclinable  
Supporto per divaricatore, inclinabile



**16-501-07** 4,0 cm, 1 1/2"



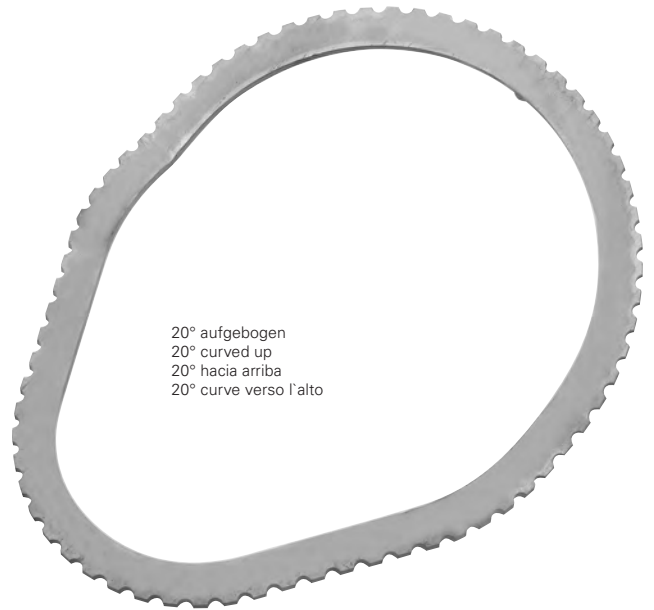
**16-502-01** 203 x 311 mm  
**16-502-02** 267 x 368 mm  
**16-502-03** 267 x 470 mm



**16-503-01** Ø 216 mm

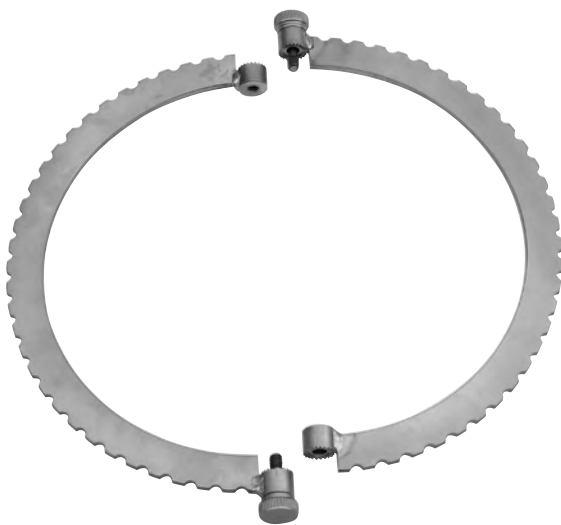
**16-503-02** Ø 266 mm

**16-503-03** Ø 317 mm



20° aufgebogen  
20° curved up  
20° hacia arriba  
20° curve verso l'alto

**16-503-04** 203 x 206 mm



**16-504-01** Ø 216 mm



**16-505-01** 216 x 356 mm

**16-505-02** 266 x 495 mm

**16-505-03** 317 x 495 mm



<b>16-506-10</b>	102 mm
<b>16-506-15</b>	152 mm
<b>16-506-20</b>	203 mm



**BALFOUR**

<b>16-510-01</b>	67 x 76 mm
------------------	------------



**DEAVER**

<b>16-511-01</b>	25 x 89 mm
<b>16-511-02</b>	25 x 127 mm



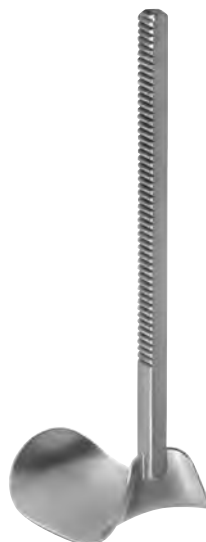
**GELPI**

<b>16-512-01</b>	
------------------	--



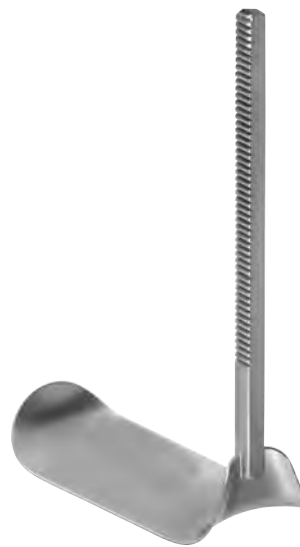
**HARRINGTON**

<b>16-513-01</b>	63 x 143 mm
------------------	-------------



**KELLY**

<b>16-514-01</b>	25 x 38 mm
<b>16-514-02</b>	25 x 63 mm



**KELLY**

<b>16-515-01</b>	51 x 51 mm
<b>16-515-02</b>	51 x 38 mm
<b>16-515-03</b>	51 x 65 mm
<b>16-515-04</b>	51 x 76 mm
<b>16-515-05</b>	51 x 101 mm
<b>16-515-06</b>	51 x 127 mm
<b>16-515-07</b>	51 x 152 mm



biegsam  
malleable  
maleable  
malleabile

<b>16-516-01</b>	38 x 152 mm
<b>16-516-02</b>	51 x 152 mm
<b>16-516-03</b>	76 x 152 mm



**MEYERDING**

<b>16-517-01</b>	60 x 17 mm
<b>16-517-02</b>	85 x 25 mm
<b>16-517-03</b>	95 x 50 mm



**16-518-01**

3 Zinker  
3 teeth  
3 dents  
3 denti

**16-518-02**

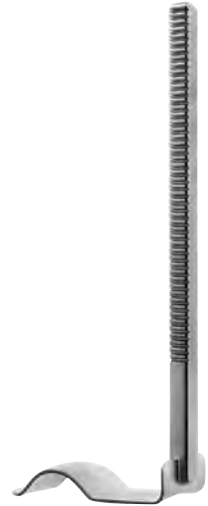
4 Zinker  
4 teeth  
4 dents  
4 denti

**16-518-03**

6 Zinker  
6 teeth  
6 dents  
6 denti

**RAKE**

<b>16-518-01</b>	19 x 17 mm
<b>16-518-02</b>	8,4 x 19 mm
<b>16-518-03</b>	8,4 x 25 mm



<b>16-519-01</b>	73 mm
<b>16-519-02</b>	98 mm



**SCOVILLE**

<b>16-520-01</b>	50 mm
<b>16-520-02</b>	83 mm



<b>16-521-01</b>	25 x 76 mm
------------------	------------



<b>16-521-02</b>	25 x 114 mm
------------------	-------------



# 17

Nadelhalter

Needle holders

Porta-agujas

Portaghi





**17-000-15**  
**17-000-18**  
**17-000-20**



**17-001-16**  
**17-001-18**  
**17-001-20**

**HEGAR**

<b>17-000-15</b>	15,0 cm, 6 "
<b>17-000-18</b>	17,5 cm, 7 "
<b>17-000-20</b>	20,0 cm, 8 "

**HEGAR**

<b>17-001-16</b>	16,0 cm, 6 ¼ "
<b>17-001-18</b>	17,5 cm, 7 "
<b>17-001-20</b>	20,0 cm, 8 "



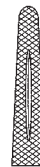
**17-002-14**



**17-002-16**



**17-002-18**



**17-002-20**



**17-002-24**



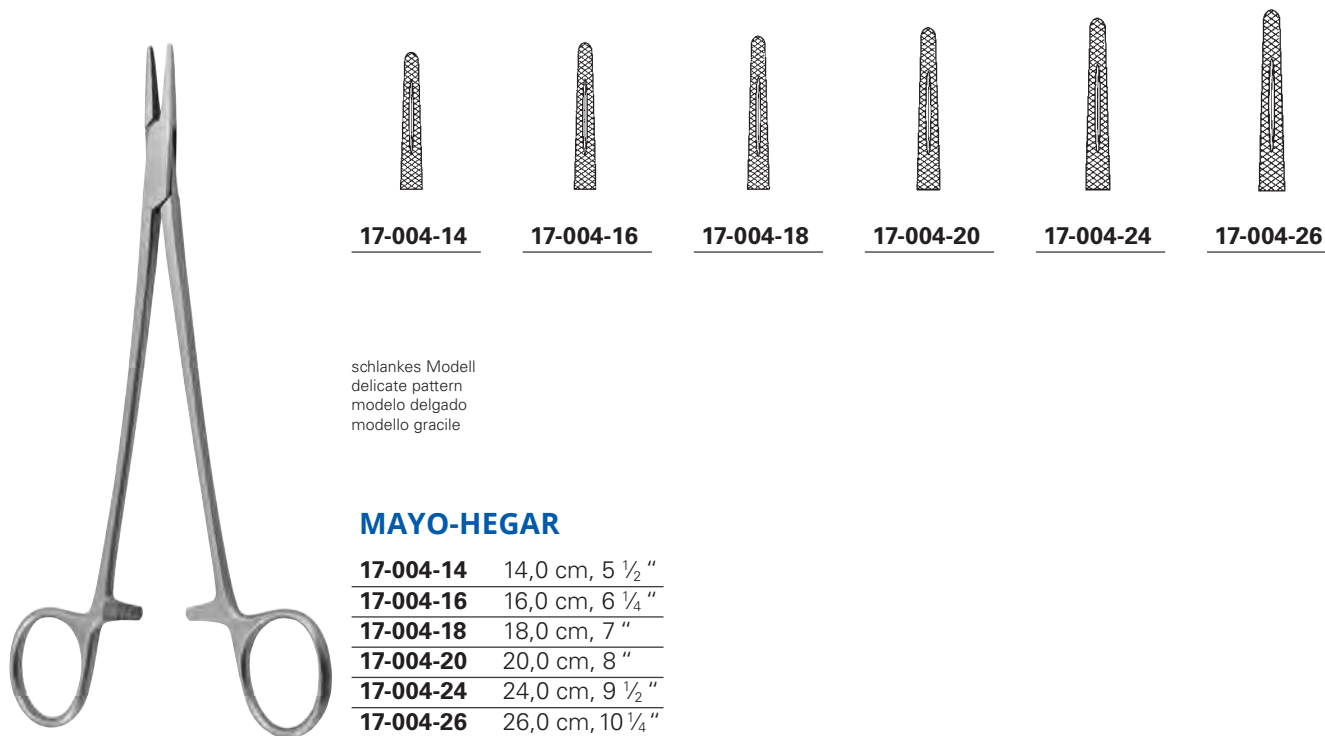
**17-002-26**



**17-002-30**

**MAYO-HEGAR**

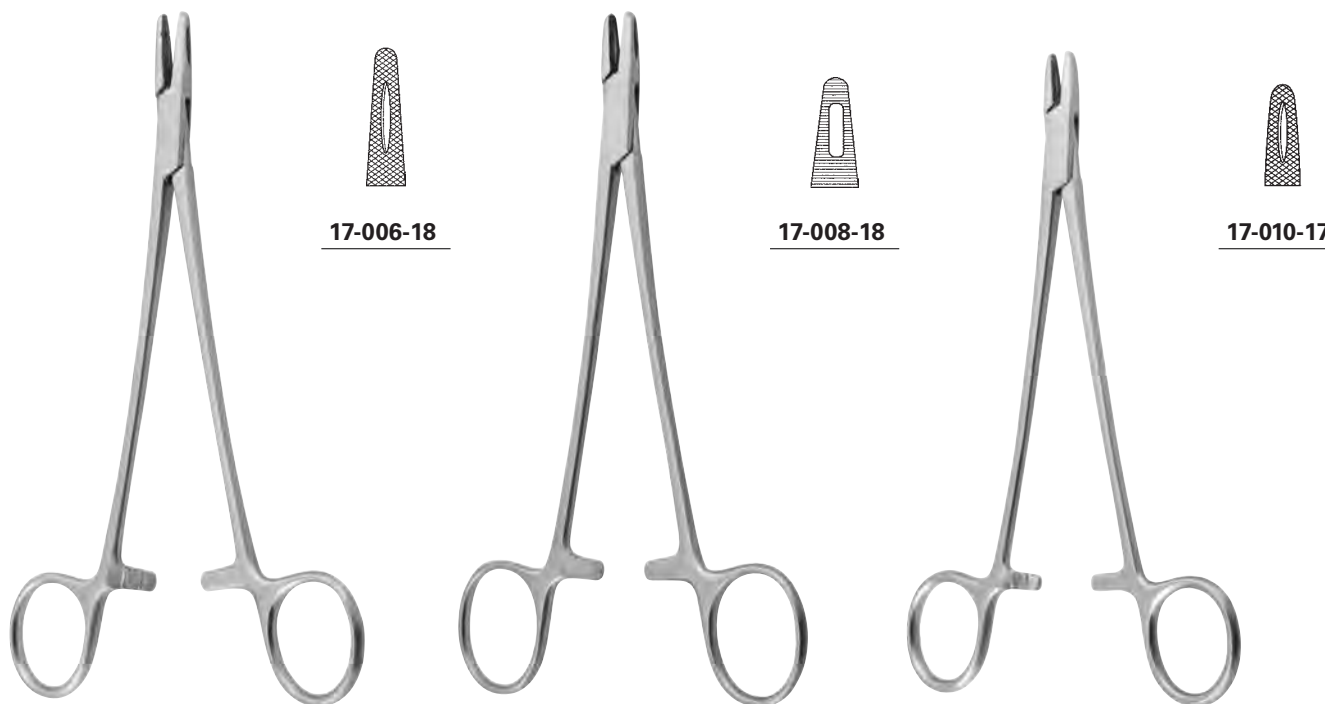
<b>17-002-14</b>	14,0 cm, 5 ½ "
<b>17-002-16</b>	16,0 cm, 6 ¼ "
<b>17-002-18</b>	18,0 cm, 7 "
<b>17-002-20</b>	20,0 cm, 8 "
<b>17-002-24</b>	24,0 cm, 9 ½ "
<b>17-002-26</b>	26,0 cm, 10 ¼ "
<b>17-002-30</b>	30,0 cm, 11 ¾ "



schlankes Modell  
delicate pattern  
modelo delgado  
modello gracile

### MAYO-HEGAR

<b>17-004-14</b>	14,0 cm, 5 ½"
<b>17-004-16</b>	16,0 cm, 6 ¼"
<b>17-004-18</b>	18,0 cm, 7"
<b>17-004-20</b>	20,0 cm, 8"
<b>17-004-24</b>	24,0 cm, 9 ½"
<b>17-004-26</b>	26,0 cm, 10 ¼"



### METZENBAUM

**17-006-18** 18,0 cm, 7"

### ADSON

**17-008-18** 18,0 cm, 7"

### M.G. HOSPITAL

**17-010-17** 17,0 cm, 6 ¾"



**CRILE-MURRAY**

**17-012-15** 15,0 cm, 6"



**17-012-15**



**CRILE-WOOD**

<b>17-014-15</b>	15,0 cm, 6"
<b>17-014-18</b>	18,0 cm, 7"
<b>17-014-20</b>	20,0 cm, 8"
<b>17-014-23</b>	23,0 cm, 9"



**17-014-15**  
**17-014-18**  
**17-014-20**  
**17-014-23**

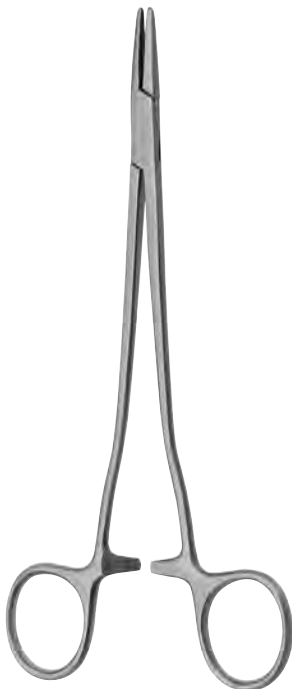


**BROWN**

<b>17-018-13</b>	13,0 cm, 5 1/8"
<b>17-018-18</b>	18,0 cm, 7"



**17-018-13**  
**17-018-18**



**SAROT**

<b>17-020-18</b>	18,0 cm, 7"
<b>17-020-26</b>	26,0 cm, 10 1/4"



**17-020-18**  
**17-020-26**



**HEGAR-BAUMGARTNER**

<b>17-022-12</b>	12,0 cm, 5"
<b>17-022-14</b>	14,0 cm, 5 1/2"



**17-022-12**



**17-022-14**



**17-024-13**

**NEIVERT**

**17-024-13** 13,0 cm, 5 1/8"

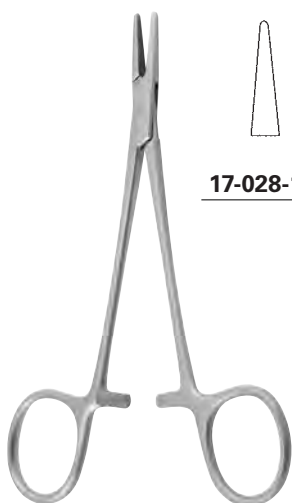


**17-026-13**

**17-030-13**

**HALSEY**

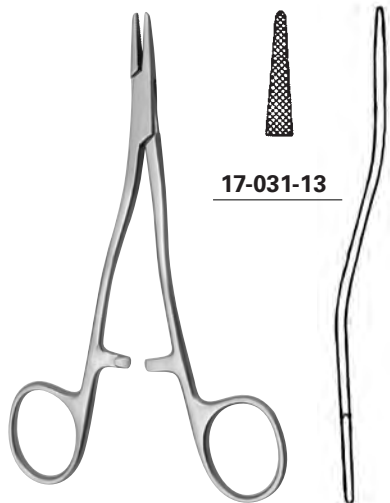
**17-026-13 - 17-030-13** 13,0 cm, 5 1/8"



**17-028-13**

**WEBSTER**

**17-028-13** 13,0 cm, 5 1/8"



**17-031-13**

**KILNER**

**17-031-13** 13,0 cm, 5 1/8"



**17-032-12**

**DERF (WRIGHT)**

**17-032-12** 12,0 cm, 4 3/4"



**17-034-12**

**DERF-CONVERSE**

**17-034-12** 12,0 cm, 4 3/4"



**17-035-12**

**DOYEN**

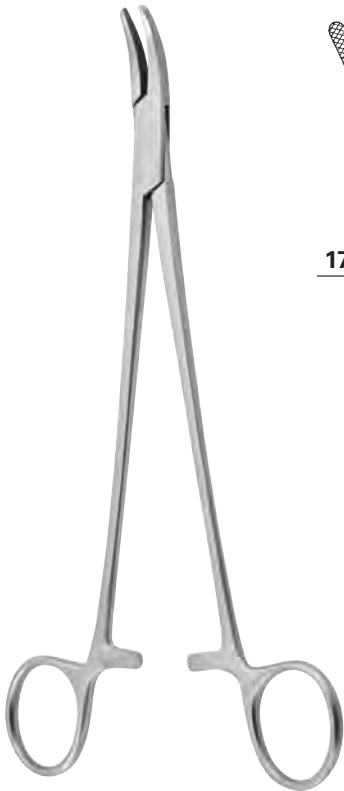
**17-035-12** 12,5 cm, 5"



**17-036-12**

**COLLIER**

**17-036-12** 12,0 cm, 4 3/4"



**17-037-21**

**HEANEY**

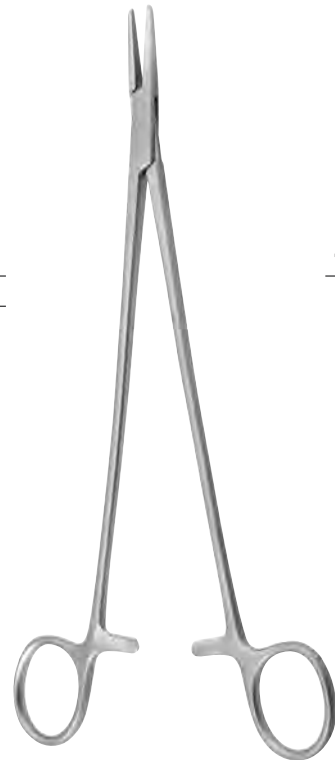
**17-037-21** 21,0 cm, 8 1/4"



**17-039-20**  
**17-039-23**

**STRATTE**

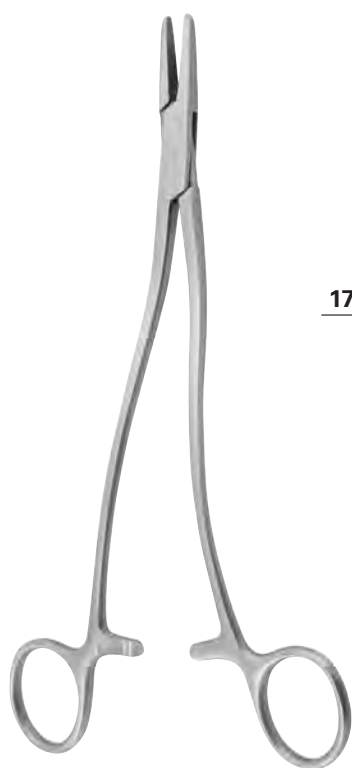
**17-039-20** 20,0 cm, 8"  
**17-039-23** 23,0 cm, 9"



**17-040-23**

**JAMESON**

**17-040-23** 23,0 cm, 9"



**17-041-20**



**17-041-24**



**17-041-26**



**17-042-27**

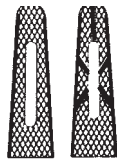
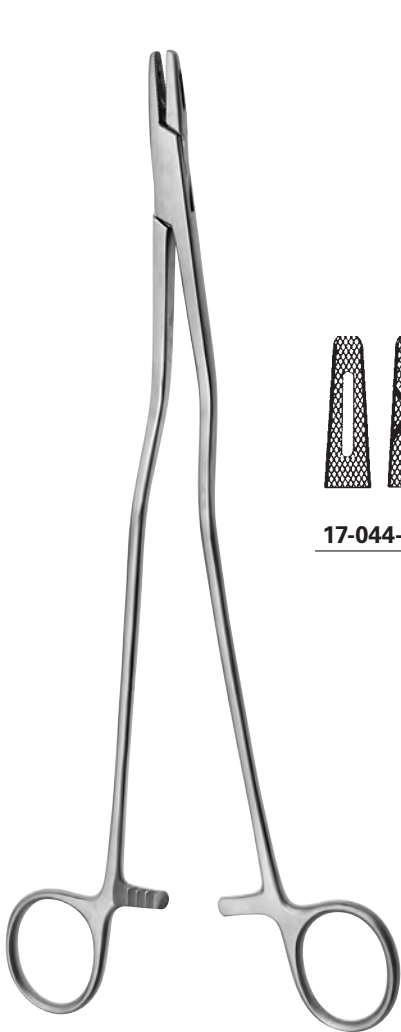


### **BOZEMANN-S**

<b>17-041-20</b>	20,0 cm, 8 "
<b>17-041-24</b>	24,0 cm, 9 ½ "
<b>17-041-26</b>	26,0 cm, 10 ¼ "

### **MASSON**

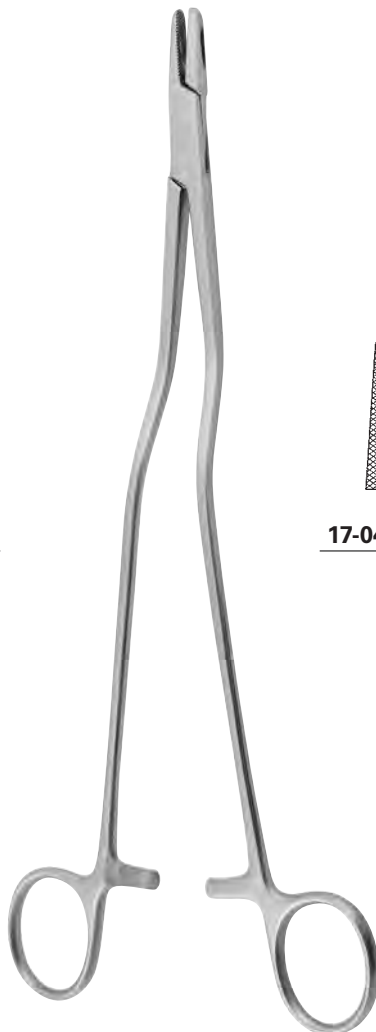
<b>17-042-27</b>	27,0 cm, 10 ¾ "
------------------	-----------------



17-044-26

**MASSON-LUETHY**

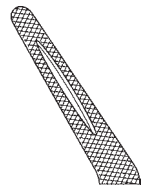
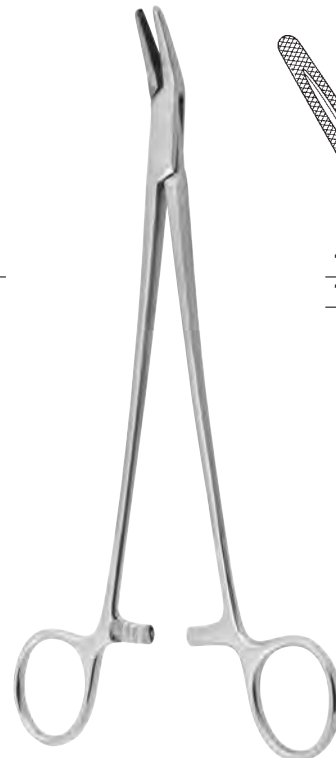
17-044-26 26,0 cm, 10 1/4"



17-044-27

**WANGENSTEEN**

17-044-27 27,0 cm, 10 3/4"



17-045-20  
17-045-27

**FINOCHIETTO**

17-045-20 20,0 cm, 8"

17-045-27 27,0 cm, 10 3/4"





**17-046-12**

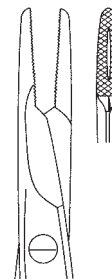


**17-047-12**



**MINI-OLSEN**

**17-046-12 - 17-047-12** 12,0 cm, 4 3/4"



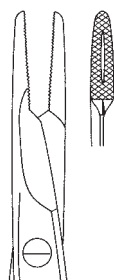
**17-048-12**

fein  
delicate  
delicato  
fino

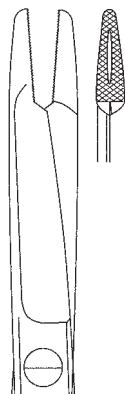


**OLSEN-HEGAR**

**17-048-12** 12,0 cm, 4 3/4"



**17-048-14**

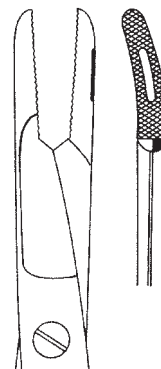


**17-048-18**



**OLSEN-HEGAR**

**17-048-14** 14,0 cm, 5 1/2"  
**17-048-18** 18,0 cm, 7"



**17-049-16**



**GILLIES**

**17-049-16** 16,0 cm, 6 1/4"



**17-050-16**



**17-051-16**

**ARRUGA**

**17-050-16 - 17-051-16** 16,0 cm, 6 ¼"



**17-052-14**



**17-052-17**



**17-052-20**

**MATHIEU**

**17-052-14** 14,0 cm, 5 ½"

**17-052-17** 17,0 cm, 6 ¾"

**17-052-20** 20,0 cm, 8"



**17-053-17**



**17-053-20**

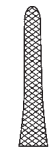
**MATHIEU**

**17-053-17** 17,0 cm, 6 ¾"

**17-053-20** 20,0 cm, 8"



**17-054-14**



**17-054-17**

**MATHIEU**

**17-054-14** 14,0 cm, 5 ½"

**17-054-17** 17,0 cm, 6 ¾"



**17-056-20**



**17-057-18**



**17-061-15**

**LICHTENBERG**

**17-056-20** 20,0 cm, 8 "

**EISELSBERG**

**17-057-18** 18,5 cm, 7 ¼ "

**CRILE**

**17-061-15** 15,0 cm, 6 "



**17-066-14**



**KALT**

**17-066-14** 13,5 cm, 5 ¼ "



**17-068-12**



**BOYNTON**

**17-068-12** 12,5 cm, 5 "



**17-070-18**



**TOENNIS**

**17-070-18** 18,0 cm, 7 "



**17-106-13 D**  
**17-106-15 D**  
**17-106-18 D**  
**17-106-20 D**  
**17-106-23 D**



**VASCULAR**

**17-106-13 D** 13,0 cm, 5 "  
**17-106-15 D** 15,0 cm, 6 "  
**17-106-18 D** 18,0 cm, 7 "  
**17-106-20 D** 20,0 cm, 8 "  
**17-106-23 D** 23,0 cm, 9 "



**17-106-13 DT**  
**17-106-15 DT**  
**17-106-18 DT**  
**17-106-20 DT**  
**17-106-23 DT**



**VASCULAR**

**17-106-13 DT** 13,0 cm, 5 "  
**17-106-15 DT** 15,0 cm, 6 "  
**17-106-18 DT** 18,0 cm, 7 "  
**17-106-20 DT** 20,0 cm, 8 "  
**17-106-23 DT** 23,0 cm, 9 "



**17-112-13 D**  
**17-112-15 D**  
**17-112-16 D**  
**17-112-18 D**  
**17-112-20 D**  
**17-112-23 D**



**RYDER**

**17-112-13 D** 13,0 cm, 5 "  
**17-112-15 D** 15,0 cm, 6 "  
**17-112-16 D** 15,0 cm, 6 1/4 "  
**17-112-18 D** 18,0 cm, 7 "  
**17-112-20 D** 20,0 cm, 8 "  
**17-112-23 D** 23,0 cm, 9 "

# 17

Mikro Instrumente  
Micro Instruments  
Instrumentos de micro  
Strumentario micro





**17-701-15**



**17-703-15**



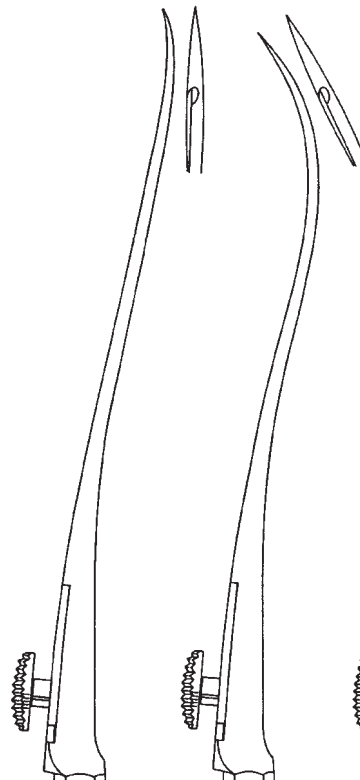
**17-705-15**



**17-707-15**

**REVERDIN**

**17-701-15 - 17-707-15** 15,0 cm, 6"



**17-701-19**

**17-701-21**

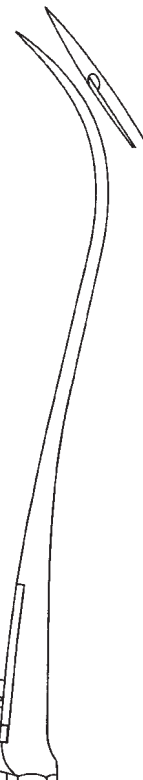
**17-701-23**



**17-703-19**

**17-703-21**

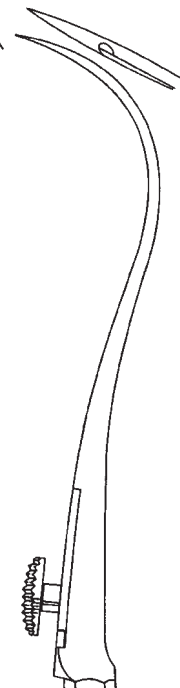
**17-703-23**



**17-705-19**

**17-705-21**

**17-705-23**



**17-707-19**

**17-707-21**

**17-707-23**

**REVERDIN**

**17-701-19 - 17-707-19** 19,0 cm, 7 ½"

**17-701-21 - 17-707-21** 21,0 cm, 8 ¼"

**17-701-23 - 17-707-23** 23,0 cm, 9"



**OBWEGESER**

**17-708-14** 14,0 cm, 5 ½ "



**OBWEGESER**

**17-708-23** 23,0 cm, 9 "



**OBWEGESER**

**17-709-18** 18,0 cm, 7 "

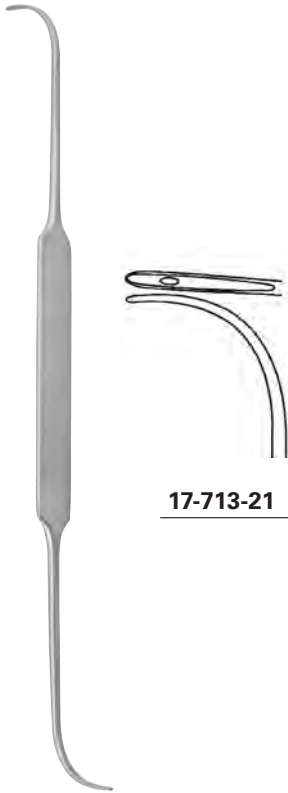


**17-711-32**

biegsam  
malleable  
maleable  
malleabile

**SCHMIEDEN-DICK**

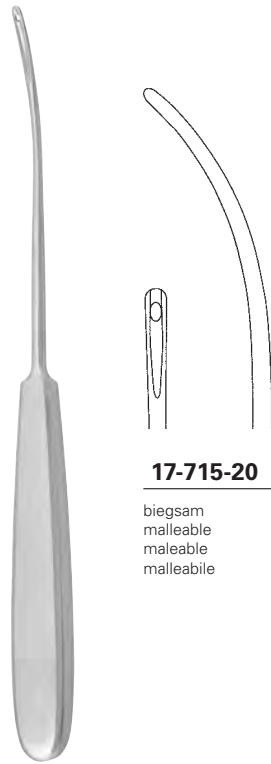
**17-711-32** 30,0 cm, 11 ¾ "



**17-713-21**

**SCHMIEDEN**

**17-713-21** 24,0 cm, 9 ½"

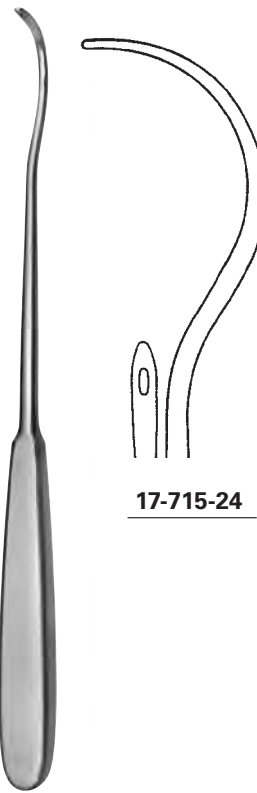


**17-715-20**

biegsam  
malleable  
maleable  
malleabile

**BRUNNER**

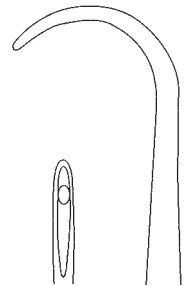
**17-715-24** 24,0 cm, 9 ½"



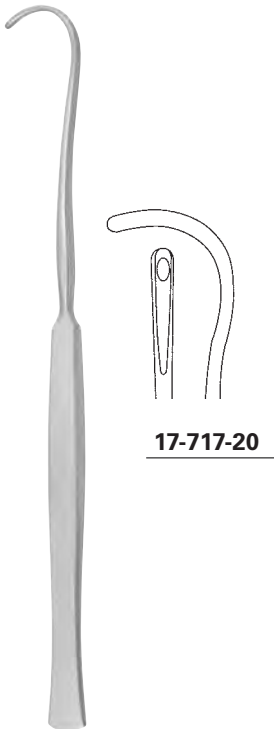
**17-715-24**

**COOPER**

**17-717-19** 19,0 cm, 7 ½"



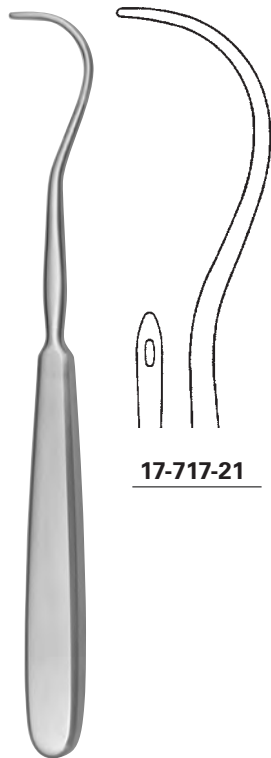
**17-717-19**



**17-717-20**

**COOPER**

**17-717-20** 20,0 cm, 8"



**17-717-21**

**KOCHER**

**17-717-21** 20,0 cm, 8"



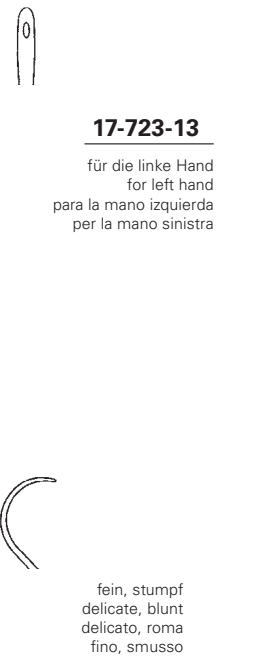
**17-721-13**

für die rechte Hand  
for right hand  
para la mano derecha  
per la mano destra

fein, stumpf  
delicate, blunt  
delicato, roma  
fino, smusso

**KRONECKER**

**17-721-13** 13,0 cm, 5 ⅛"



**17-723-13**

für die linke Hand  
for left hand  
para la mano izquierda  
per la mano sinistra

fein, stumpf  
delicate, blunt  
delicato, roma  
fino, smusso

**KRONECKER**

**17-723-13** 13,0 cm, 5 ⅛"

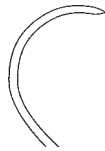




**17-725-20**

für die rechte Hand  
for right hand  
para la mano derecha  
per la mano destra

scharf  
sharp  
aguda  
acuto



**17-726-20**

für die linke Hand  
for left hand  
para la mano izquierda  
per la mano sinistra

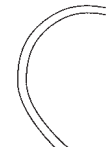
scharf  
sharp  
aguda  
acuto



**17-727-20**

für die rechte Hand  
for right hand  
para la mano derecha  
per la mano destra

stumpf  
blunt  
roma  
smusso



**17-728-20**

für die linke Hand  
for left hand  
para la mano izquierda  
per la mano sinistra

stumpf  
blunt  
roma  
smusso



**DESCHAMPS**

**17-725-20** 20,0 cm, 8"

**DESCHAMPS**

**17-726-20** 20,0 cm, 8"

**DESCHAMPS**

**17-727-20** 20,0 cm, 8"

**DESCHAMPS**

**17-728-20** 20,0 cm, 8"



**17-729-20**

für die rechte Hand  
for right hand  
para la mano derecha  
per la mano destra

stumpf  
blunt  
roma  
smusso



**17-730-20**

für die linke Hand  
for left hand  
para la mano izquierda  
per la mano sinistra

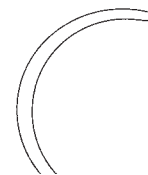
stumpf  
blunt  
roma  
smusso



**17-731-20**

für die rechte Hand  
for right hand  
para la mano derecha  
per la mano destra

stumpf  
blunt  
roma  
smusso



**17-733-20**

für die linke Hand  
for left hand  
para la mano izquierda  
per la mano sinistra

stumpf  
blunt  
roma  
smusso



**DESCHAMPS**

**17-729-20** 20,0 cm, 8"

**DESCHAMPS**

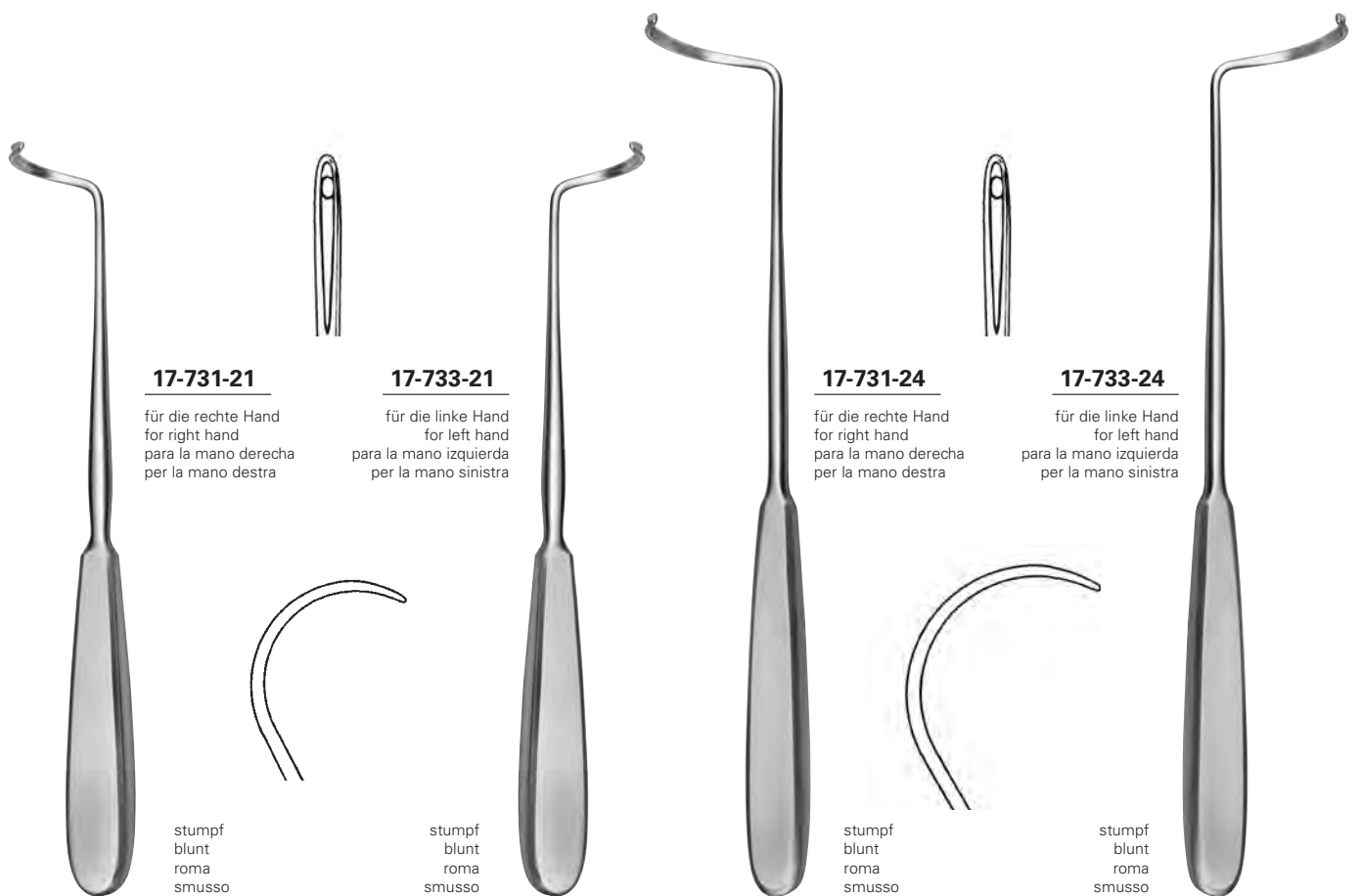
**17-730-20** 20,0 cm, 8"

**DESCHAMPS**

**17-731-20** 20,0 cm, 8"

**DESCHAMPS**

**17-733-20** 20,0 cm, 8"



**17-731-21**

für die rechte Hand  
for right hand  
para la mano derecha  
per la mano destra

stumpf  
blunt  
roma  
smusso

**17-733-21**

für die linke Hand  
for left hand  
para la mano izquierda  
per la mano sinistra

stumpf  
blunt  
roma  
smusso

**17-731-24**

für die rechte Hand  
for right hand  
para la mano derecha  
per la mano destra

stumpf  
blunt  
roma  
smusso

**17-733-24**

für die linke Hand  
for left hand  
para la mano izquierda  
per la mano sinistra

stumpf  
blunt  
roma  
smusso

**DESCHAMPS**

**17-731-21** 21,0 cm, 8 ¼"

**DESCHAMPS**

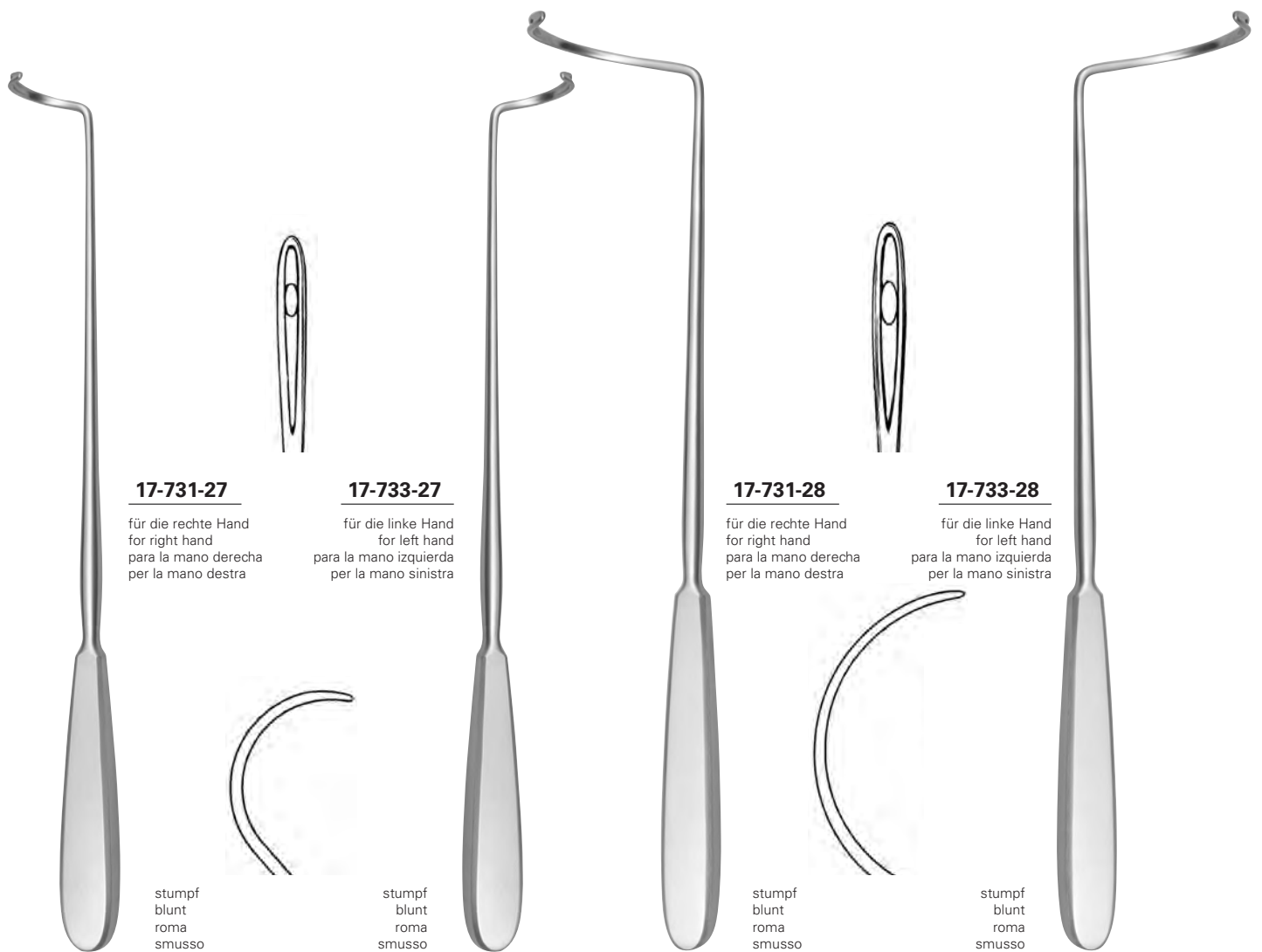
**17-733-21** 21,0 cm, 8 ¼"

**DESCHAMPS**

**17-731-24** 24,0 cm, 9 ½"

**DESCHAMPS**

**17-733-24** 24,0 cm, 9 ½"



**17-731-27**

für die rechte Hand  
 for right hand  
 para la mano derecha  
 per la mano destra

stumpf  
 blunt  
 roma  
 smusso

**17-733-27**

für die linke Hand  
 for left hand  
 para la mano izquierda  
 per la mano sinistra

stumpf  
 blunt  
 roma  
 smusso

**17-731-28**

für die rechte Hand  
 for right hand  
 para la mano derecha  
 per la mano destra

stumpf  
 blunt  
 roma  
 smusso

**17-733-28**

für die linke Hand  
 for left hand  
 para la mano izquierda  
 per la mano sinistra

stumpf  
 blunt  
 roma  
 smusso

**DESCHAMPS**

**17-731-27** 27,0 cm, 10 3/4"

**DESCHAMPS**

**17-733-27** 27,0 cm, 10 3/4"

**DESCHAMPS**

**17-731-28** 28,0 cm, 11 "

**DESCHAMPS**

**17-733-28** 28,0 cm, 11 "



**17-735-19**

für die rechte Hand  
for right hand  
para la mano derecha  
per la mano destra



**17-737-19**

für die linke Hand  
for left hand  
para la mano izquierda  
per la mano sinistra



scharf  
sharp  
aguda  
acuto

scharf  
sharp  
aguda  
acuto



**17-735-20**

für die rechte Hand  
for right hand  
para la mano derecha  
per la mano destra



**17-737-20**

für die linke Hand  
for left hand  
para la mano izquierda  
per la mano sinistra



scharf  
sharp  
aguda  
acuto

scharf  
sharp  
aguda  
acuto



**DESCHAMPS**

**17-735-19** 20,0 cm, 8 "

**DESCHAMPS**

**17-737-19** 20,0 cm, 8 "

**DESCHAMPS**

**17-735-20** 20,0 cm, 8 "

**DESCHAMPS**

**17-737-20** 20,0 cm, 8 "



**17-735-21**

für die rechte Hand  
for right hand  
para la mano derecha  
per la mano destra



**17-737-21**

für die linke Hand  
for left hand  
para la mano izquierda  
per la mano sinistra



scharf  
sharp  
aguda  
acuto

scharf  
sharp  
aguda  
acuto



**17-735-24**

für die rechte Hand  
for right hand  
para la mano derecha  
per la mano destra



**17-737-24**

für die linke Hand  
for left hand  
para la mano izquierda  
per la mano sinistra



scharf  
sharp  
aguda  
acuto

scharf  
sharp  
aguda  
acuto



**DESCHAMPS**

**17-735-21** 21,0 cm, 8 ¼ "

**DESCHAMPS**

**17-737-21** 21,0 cm, 8 ¼ "

**DESCHAMPS**

**17-735-24** 24,0 cm, 9 ½ "

**DESCHAMPS**

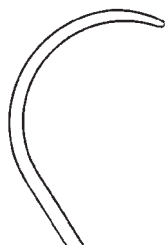
**17-737-24** 24,0 cm, 9 ½ "



**17-735-27**

für die rechte Hand  
 for right hand  
 para la mano derecha  
 per la mano destra

scharf  
 sharp  
 aguda  
 acuto



**17-737-27**

für die linke Hand  
 for left hand  
 para la mano izquierda  
 per la mano sinistra

scharf  
 sharp  
 aguda  
 acuto



**17-738-21**

für die rechte Hand  
 for right hand  
 para la mano derecha  
 per la mano destra

stumpf  
 blunt  
 roma  
 smusso



**17-739-21**

für die linke Hand  
 for left hand  
 para la mano izquierda  
 per la mano sinistra

stumpf  
 blunt  
 roma  
 smusso



**DESCHAMPS**

**17-735-27** 27,0 cm, 10<sup>3</sup>/<sub>4</sub>"

**DESCHAMPS**

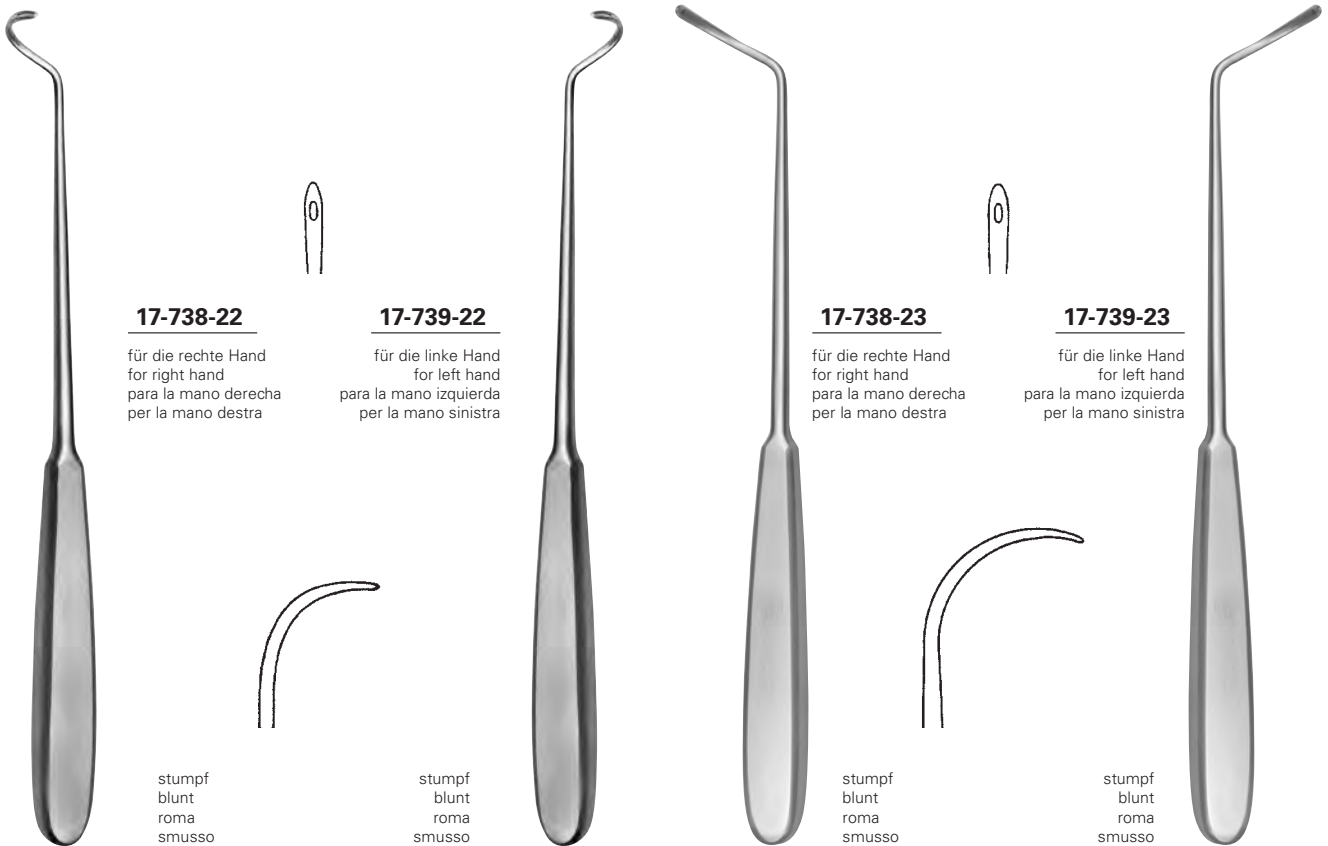
**17-737-27** 27,0 cm, 10<sup>3</sup>/<sub>4</sub>"

**DESCHAMPS**

**17-738-21** 22,5 cm, 9"

**DESCHAMPS**

**17-739-21** 22,5 cm, 9"



**17-738-22**

für die rechte Hand  
for right hand  
para la mano derecha  
per la mano destra

stumpf  
blunt  
roma  
smusso

**17-739-22**

für die linke Hand  
for left hand  
para la mano izquierda  
per la mano sinistra

stumpf  
blunt  
roma  
smusso

**17-738-23**

für die rechte Hand  
for right hand  
para la mano derecha  
per la mano destra

stumpf  
blunt  
roma  
smusso

**17-739-23**

für die linke Hand  
for left hand  
para la mano izquierda  
per la mano sinistra

stumpf  
blunt  
roma  
smusso

**DESCHAMPS**

**17-738-22** 22,5 cm, 9"

**DESCHAMPS**

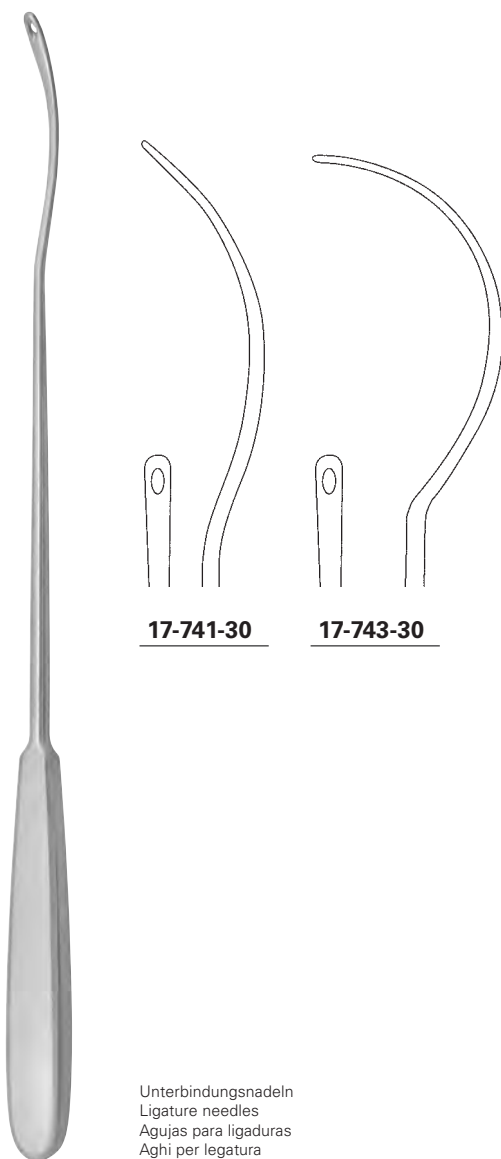
**17-739-22** 22,5 cm, 9"

**DESCHAMPS**

**17-738-23** 23,0 cm, 9"

**DESCHAMPS**

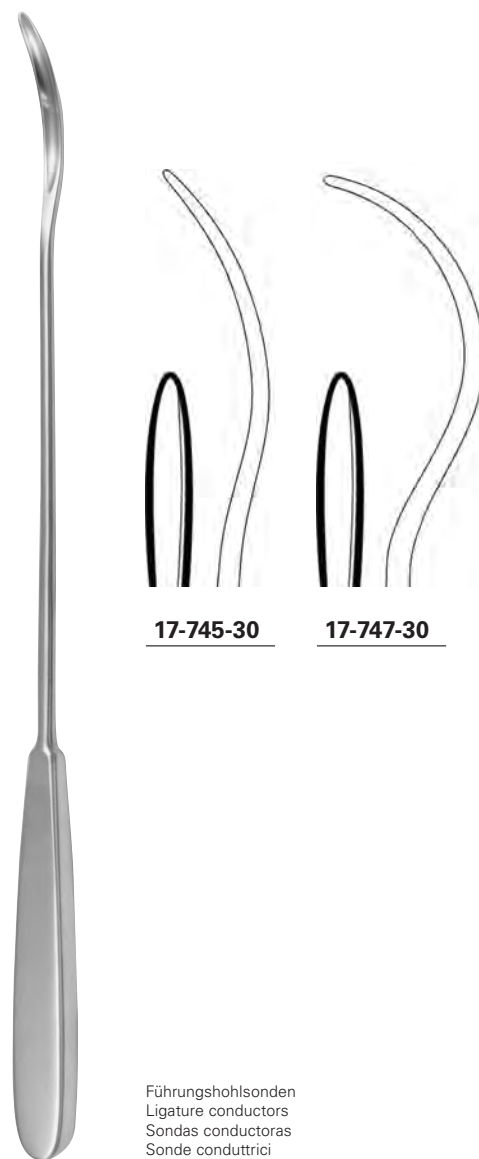
**17-739-23** 23,0 cm, 9"



Unterbindungsnadeln  
Ligature needles  
Agujas para ligaduras  
Aghi per legatura

**BRUNNER**

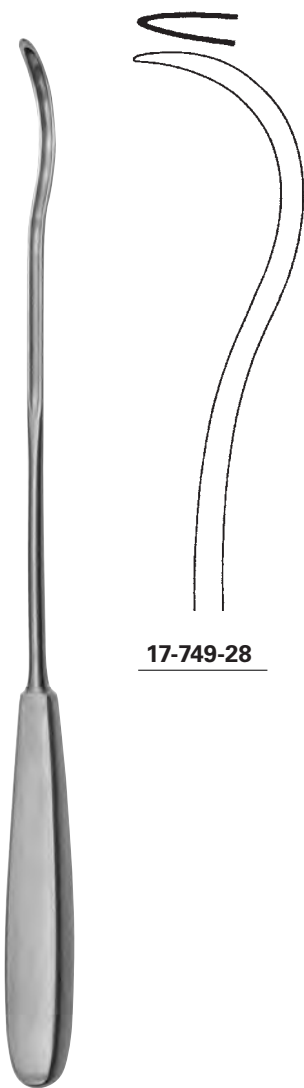
**17-741-30 - 17-743-30** 30,0 cm, 11 3/4"



Führungshohlsonden  
Ligature conductors  
Sondas conductoras  
Sonde conduttrici

**BRUNNER**

**17-745-30 - 17-747-30** 30,0 cm, 11 3/4"



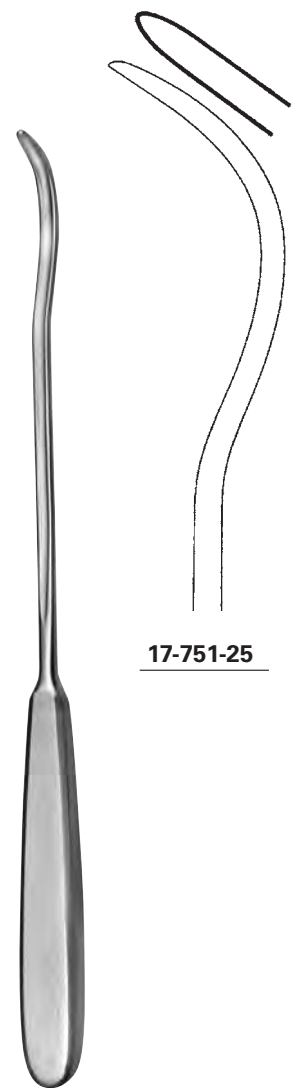
**17-749-28**

**17-749-28** 28,0 cm, 11 "



**JONESCO**

**17-751-18** 18,5 cm, 7 "

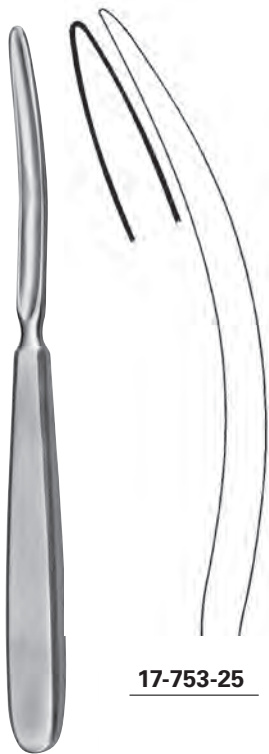


**17-751-25**

**KIRSCHNER**

**17-751-25** 25,5 cm, 10 "





**17-753-25**

**17-753-25** 19,5 cm, 7 3/4 "



**BRUNNER**

**17-755-18** 18,0 cm, 7 "  
**17-755-27** 27,0 cm, 10 3/4 "



**KIRSCHNER**

**17-757-27** 27,0 cm, 10 3/4 "



**17-758-19**

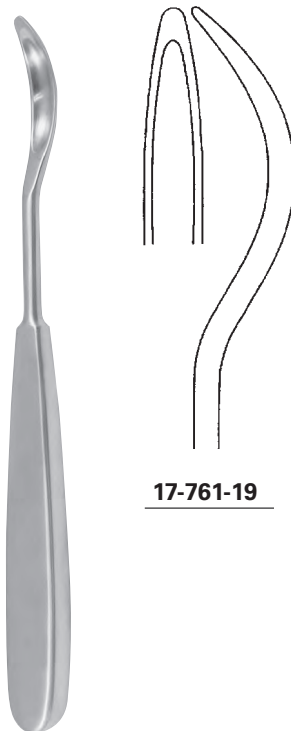
gerade  
 straight  
 recta  
 retta

**17-759-19**

gebogen  
 curved  
 curva  
 curva



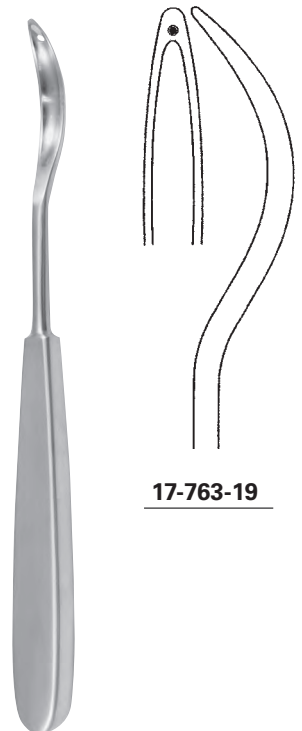
**17-758-19 - 17-759-19** 19,0 cm, 7 1/2 "



**17-761-19**

**SCHMIEDEN**

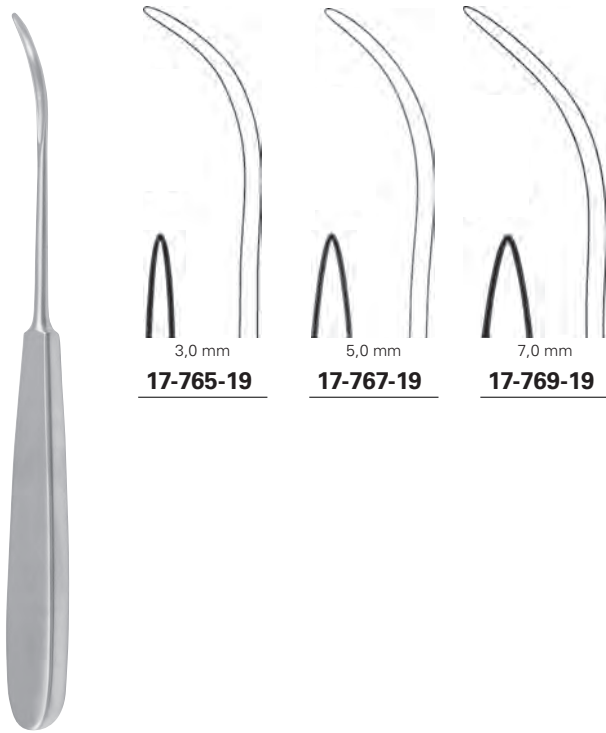
**17-761-19** 19,0 cm, 7 1/2 "



**17-763-19**

**SCHMIEDEN-PAYR**

**17-763-19** 19,0 cm, 7 1/2 "



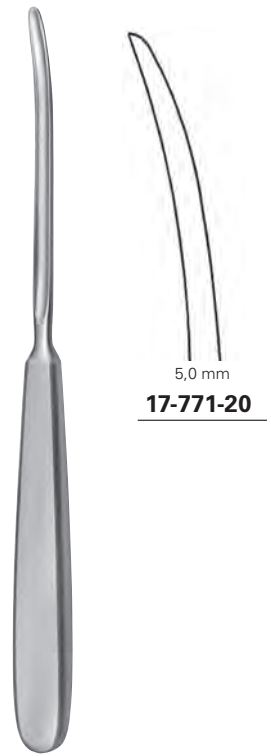
3,0 mm  
**17-765-19**

5,0 mm  
**17-767-19**

7,0 mm  
**17-769-19**

**KOENIG**

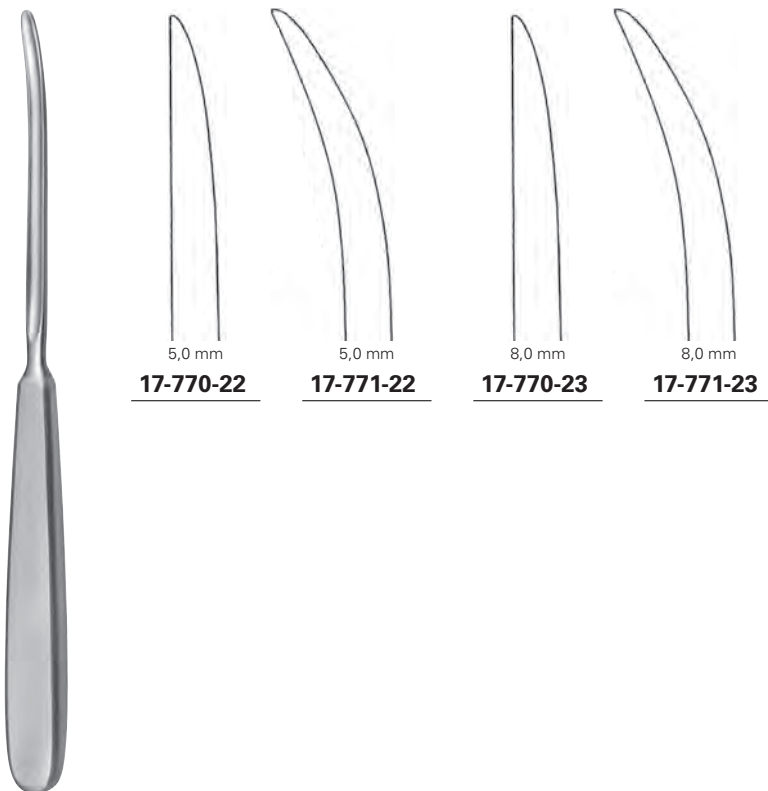
**17-765-19 - 17-769-19** 19,0 cm, 7 ½"



5,0 mm  
**17-771-20**

**PAYR**

**17-771-20** 20,0 cm, 8"



5,0 mm  
**17-770-22**

5,0 mm  
**17-771-22**

8,0 mm  
**17-770-23**

8,0 mm  
**17-771-23**

**PAYR**

**17-770-22 - 17-771-23** 22,0 cm, 8 ¾"



**17-772-24** 24,0 cm, 9 ½"



**17-773-18** 18,5 cm, 7 ¼"



Fadengabel  
 Ligature adjuster  
 Horquilla de hilos  
 Forchetta da sutura

**17-786-23** 23,0 cm, 9"



Fadenfänger  
 Ligature catcher  
 Captador de hilos  
 Portalegature

**MOD. VIENNA (WIEN)**

**17-787-24** 23,5 cm, 9 ¼"

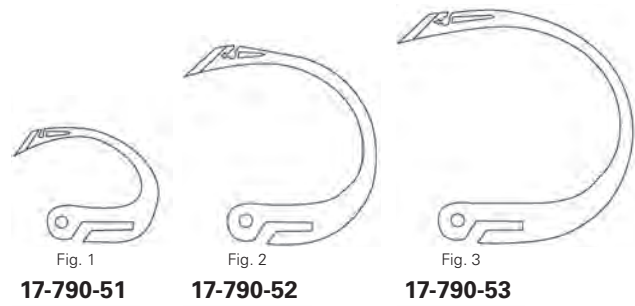


Fig. 1  
**17-790-51**

Fig. 2  
**17-790-52**

Fig. 3  
**17-790-53**

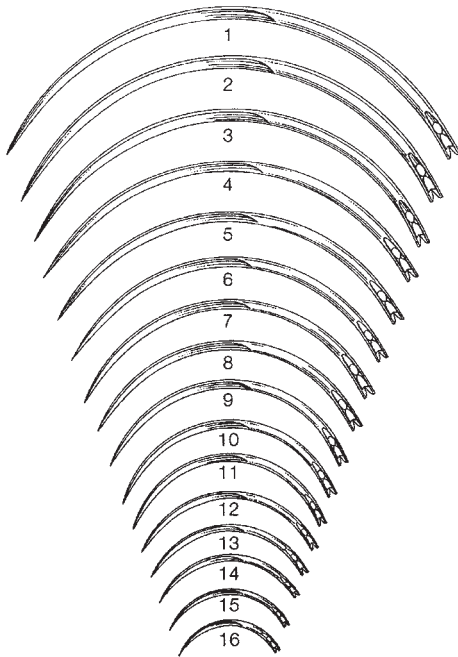
komplett mit einem Nadelaufsatz Fig. 1 | 17-790-51  
 complete with one needle Fig.1 | 17-790-51  
 completo con una aguja Fig.1 | 17-790-51  
 completo con un ago Fig.1 | 17-790-51

**YOUNG-HRYNTSCHAK**

**17-790-24** 24,0 cm, 9 ½"



Verpackungseinheit: 12 St.  
Packing unit: 12 pieces  
Unidad: 12 piezas  
Confezione: 12 pezzi



gebogen  $\frac{3}{8}$  Kreis  
curved  $\frac{3}{8}$  circle  
curvas  $\frac{3}{8}$  círculo  
curvi  $\frac{3}{8}$  circolo

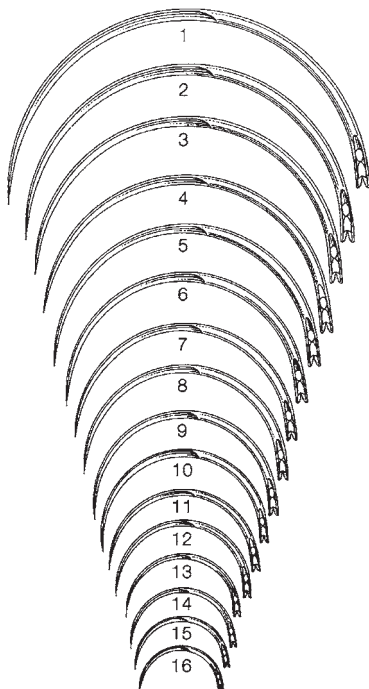


## B

<b>17-803-01</b>	Fig. 1
<b>17-803-02</b>	Fig. 2
<b>17-803-03</b>	Fig. 3
<b>17-803-04</b>	Fig. 4
<b>17-803-05</b>	Fig. 5
<b>17-803-06</b>	Fig. 6
<b>17-803-07</b>	Fig. 7
<b>17-803-08</b>	Fig. 8
<b>17-803-09</b>	Fig. 9
<b>17-803-10</b>	Fig. 10
<b>17-803-11</b>	Fig. 11
<b>17-803-12</b>	Fig. 12
<b>17-803-13</b>	Fig. 13
<b>17-803-14</b>	Fig. 14
<b>17-803-15</b>	Fig. 15
<b>17-803-16</b>	Fig. 16



Verpackungseinheit: 12 St.  
Packing unit: 12 pieces  
Unidad: 12 piezas  
Confezione: 12 pezzi



gebogen  $\frac{1}{2}$  Kreis  
curved  $\frac{1}{2}$  circle  
curvas  $\frac{1}{2}$  círculo  
curvi  $\frac{1}{2}$  circolo

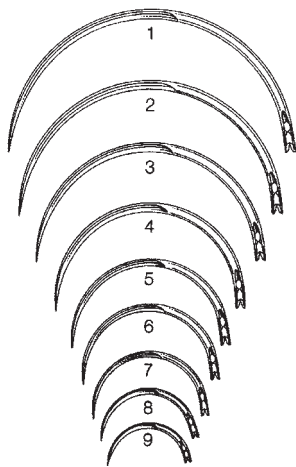


## G

<b>17-817-01</b>	Fig. 1
<b>17-817-02</b>	Fig. 2
<b>17-817-03</b>	Fig. 3
<b>17-817-04</b>	Fig. 4
<b>17-817-05</b>	Fig. 5
<b>17-817-06</b>	Fig. 6
<b>17-817-07</b>	Fig. 7
<b>17-817-08</b>	Fig. 8
<b>17-817-09</b>	Fig. 9
<b>17-817-10</b>	Fig. 10
<b>17-817-11</b>	Fig. 11
<b>17-817-12</b>	Fig. 12
<b>17-817-13</b>	Fig. 13
<b>17-817-14</b>	Fig. 14
<b>17-817-15</b>	Fig. 15
<b>17-817-16</b>	Fig. 16



Verpackungseinheit: 12 St.  
Packing unit: 12 pieces  
Unidad: 12 piezas  
Confezione: 12 pezzi



gebogen 1/2 Kreis  
curved 1/2 circle  
curvas 1/2 círculo  
curvi 1/2 circolo

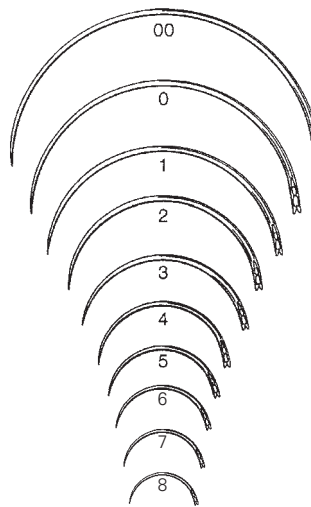


### Ga

<b>17-819-01</b>	Fig. 1
<b>17-819-02</b>	Fig. 2
<b>17-819-03</b>	Fig. 3
<b>17-819-04</b>	Fig. 4
<b>17-819-05</b>	Fig. 5
<b>17-819-06</b>	Fig. 6
<b>17-819-07</b>	Fig. 7
<b>17-819-08</b>	Fig. 8
<b>17-819-09</b>	Fig. 9



Verpackungseinheit: 12 St.  
Packing unit: 12 pieces  
Unidad: 12 piezas  
Confezione: 12 pezzi



gebogen 1/2 Kreis  
curved 1/2 circle  
curvas 1/2 círculo  
curvi 1/2 circolo

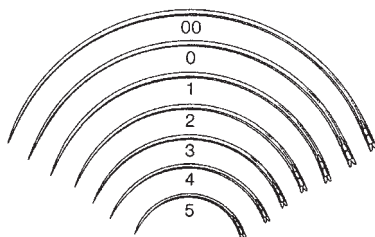


### Pb

<b>17-851-02</b>	Fig. 00
<b>17-851-03</b>	Fig. 0
<b>17-853-01</b>	Fig. 1
<b>17-853-02</b>	Fig. 2
<b>17-853-03</b>	Fig. 3
<b>17-853-04</b>	Fig. 4
<b>17-853-05</b>	Fig. 5
<b>17-853-06</b>	Fig. 6
<b>17-853-07</b>	Fig. 7
<b>17-853-08</b>	Fig. 8



Verpackungseinheit: 12 St.  
Packing unit: 12 pieces  
Unidad: 12 piezas  
Confezione: 12 pezzi



gebogen 3/8 Kreis  
curved 3/8 circle  
curvas 3/8 círculo  
curvi 3/8 circolo

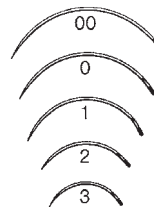


### Pd

<b>17-855-02</b>	Fig. 00
<b>17-855-03</b>	Fig. 0
<b>17-857-01</b>	Fig. 1
<b>17-857-02</b>	Fig. 2
<b>17-857-03</b>	Fig. 3
<b>17-857-04</b>	Fig. 4
<b>17-857-05</b>	Fig. 5



Verpackungseinheit: 12 St.  
Packing unit: 12 pieces  
Unidad: 12 piezas  
Confezione: 12 pezzi

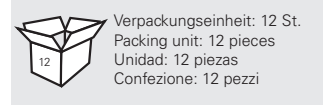
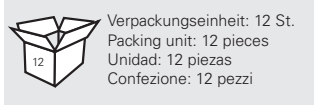


gebogen 3/8 Kreis  
curved 3/8 circle  
curvas 3/8 círculo  
curvi 3/8 circolo



### KALT

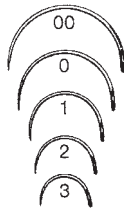
<b>17-871-02</b>	Fig. 00
<b>17-871-03</b>	Fig. 0
<b>17-873-01</b>	Fig. 1
<b>17-873-02</b>	Fig. 2
<b>17-873-03</b>	Fig. 3



gebogen 1/2 Kreis  
curved 1/2 circle  
curvas 1/2 círculo  
curvi 1/2 circolo

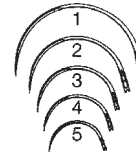


gebogen 1/2 Kreis  
curved 1/2 circle  
curvas 1/2 círculo  
curvi 1/2 circolo

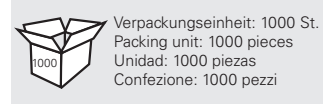
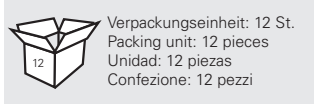
**PAYR**

- |                  |         |
|------------------|---------|
| <b>17-877-02</b> | Fig. 00 |
| <b>17-877-03</b> | Fig. 0  |
| <b>17-879-01</b> | Fig. 1  |
| <b>17-879-02</b> | Fig. 2  |
| <b>17-879-03</b> | Fig. 3  |



**Og**


- |                  |        |
|------------------|--------|
| <b>17-881-01</b> | Fig. 1 |
| <b>17-881-02</b> | Fig. 2 |
| <b>17-881-03</b> | Fig. 3 |
| <b>17-881-04</b> | Fig. 4 |
| <b>17-881-05</b> | Fig. 5 |



gebogen 3/8 Kreis  
curved 3/8 circle  
curvas 3/8 círculo  
curvi 3/8 circolo



Wundklammern  
Suture Clips  
Agrafes de sutura  
Agrafe da sutura

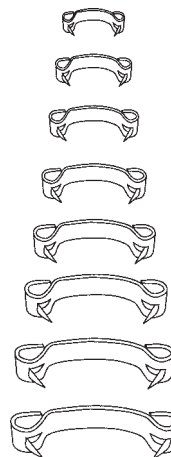
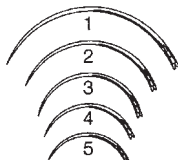


**MICHEL**

- |                  |               |
|------------------|---------------|
| <b>17-902-07</b> | 7,5 x 1,75 mm |
| <b>17-902-11</b> | 11,0 x 2,0 mm |
| <b>17-902-12</b> | 12,0 x 3,0 mm |
| <b>17-902-14</b> | 14,0 x 3,0 mm |
| <b>17-902-16</b> | 16,0 x 3,0 mm |
| <b>17-902-18</b> | 18,0 x 3,0 mm |
| <b>17-902-20</b> | 20,0 x 3,0 mm |
| <b>17-902-22</b> | 22,0 x 3,0 mm |

**Ob**

- |                  |        |
|------------------|--------|
| <b>17-883-01</b> | Fig. 1 |
| <b>17-883-02</b> | Fig. 2 |
| <b>17-883-03</b> | Fig. 3 |
| <b>17-883-04</b> | Fig. 4 |
| <b>17-883-05</b> | Fig. 5 |





Klammeranlege- und Entfernungszange  
 Clip applying and removing forceps  
 Pinza para poner y quitar agrafes  
 Pinze per mettere e togliere clips



**MICHEL**

**17-907-12** 12,5 cm, 5 "



**MICHEL**

**17-909-13** 13,0 cm, 5 1/8 "



**MICHEL**

**17-910-12** 12,0 cm, 4 3/4 "



**WACHENFELDT**

**17-911-12** 12,5 cm, 5 "



**WACHENFELDT**

**17-912-12** 12,5 cm, 5 "



**HEGENBARTH**

**17-916-12** 12,0 cm, 4 3/4 "



**CHILDE**

**17-918-01** 18,0 cm, 7 "



**CHILDE**

**17-918-02** 18,0 cm, 7 "



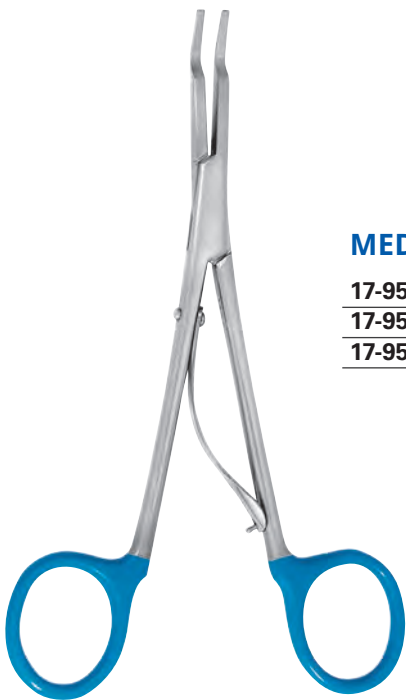
**COLLIN**

**17-932-13** 13,5 cm, 5 ¼"



**RICHTER-HEATH**

**17-933-14** 13,5 cm, 5 ¼"



**SMALL**

**17-950-15** 14,5 cm, 5 ¾"

**17-950-18** 18,5 cm, 7 ¼"

**17-950-28** 27,5 cm, 10 ¾"



**MEDIUM**

**17-952-14** 14,5 cm, 5 ¾"

**17-952-18** 18,5 cm, 7 ¼"

**17-952-28** 27,5 cm, 10 ¾"



**MEDIUM-LARGE**

**17-953-19** 18,5 cm, 7 ¼"

**17-953-28** 27,5 cm, 10 ¾"



**LARGE**

**17-954-18** 18,5 cm, 7 ¼"

**17-954-28** 27,5 cm, 10 ¾"

Klammeranlegezangen ETHICON  
Clip applying forceps ETHICON  
Pinzas para poner agrafes ETHICON  
Pinze per mettere clips ETHICON





# 18

Nadelhalter mit  
Hartmetalleinlagen

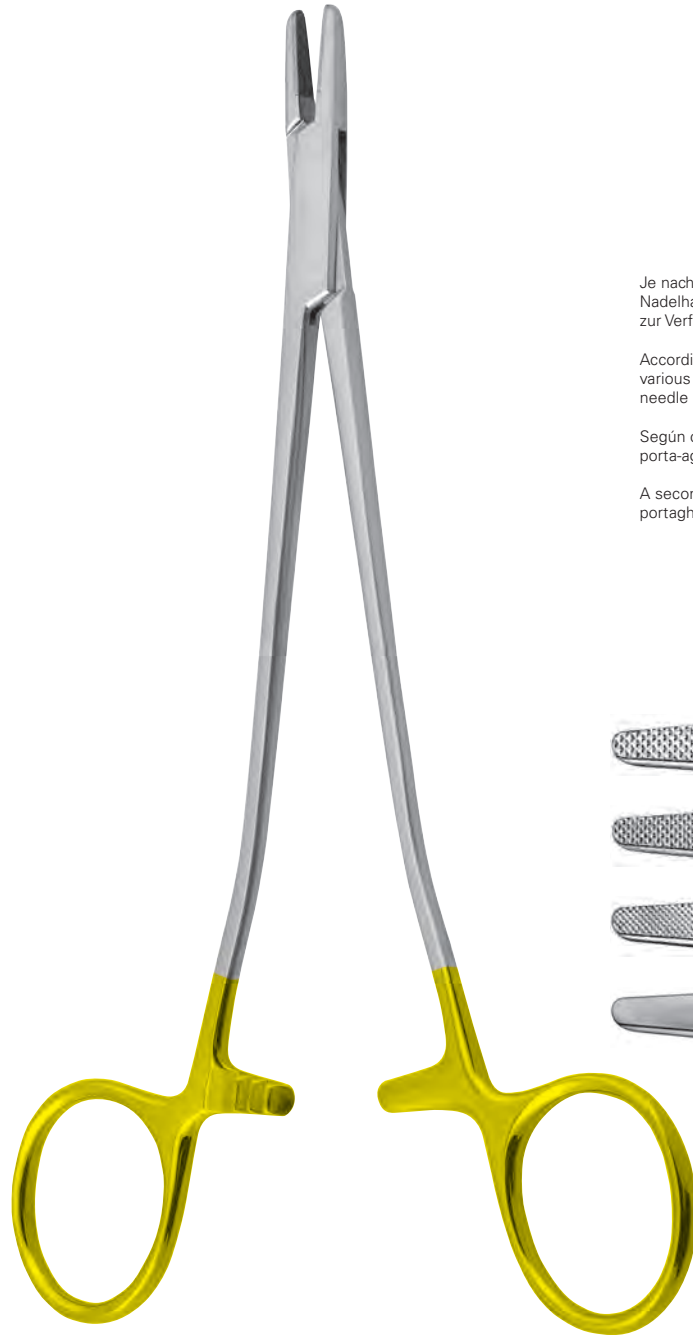
Needle Holders with  
tungsten carbide inserts

Porta-agujas con bocas  
de carburo tungsteno

Portaghi con morsi in  
carburo di tungsteno



Kennzeichnung: goldene Ringe  
 Characteristic: golden rings  
 Característica: mangos dorados  
 Caratteristica: anelli dorata



Je nach Anwendungsgebiet stehen für TC Nadelhalter unterschiedliche Hartmetalleinlagen zur Verfügung:

According to the field of application, there are various types of tungsten carbide inserts for TC needle holders:

Según campo de aplicación, disponemos de TC porta-agujas con varias capas intermedias:

A seconda delle necessità disponiamo di TC portaghi con varie capacità intermedie:

für Nahtmaterial  
 for suture material  
 para suturas  
 per materiale di suture

Riefung  
 Serration  
 Estradadura  
 Struttura



0,5 mm



0,4 mm



0,3 mm

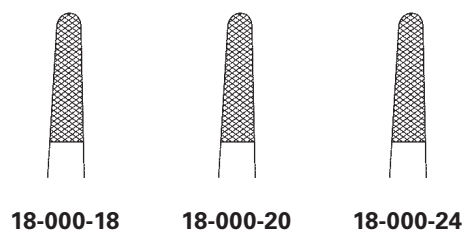


glatt  
 smoth  
 liso  
 liscie

- Hartmetalleinlagen mit präzise gearbeitetem Pyramidenprofil garantieren einen sicheren Halt der Nadel.
- Gebrochene Kanten verhindern ein Verfangen des Nahtmaterials.
- Die leichtgängige Sperre ermöglicht eine sichere Arbeitsweise.
- Tungsten carbide inserts with precisely worked out structure guarantee a secure grip of the needle.
- Bevelled edges to prevent catching of suture material.
- Soft working catch provides safe handling.
- Capas intermedias de carburo tungsteno con perfil amoldado piramidal que garantiza un sujeto seguro de la aguja.
- Bordes quebrados evitan que se enredare el material de sutura.
- El cierre suave facilita un manejo seguro.
- Inserti in carburo di tungsteno che garantiscono una perfettatenuta dell'ago.
- I bordi squadrati evitano che si impigliano i fili di sutura.
- Il bloccaggio leggero e preciso facilita un uso sicuro.

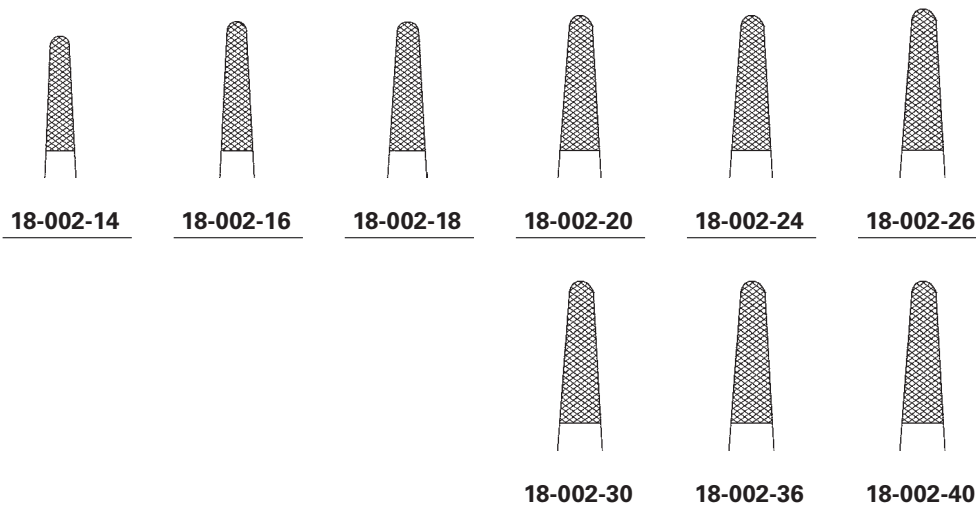


Nadelhalter mit Hartmetalleinlagen  
 Needle holders with tungsten carbide inserts  
 Porta-agujas con bocas de carburo tungsteno  
 Portaghi con morsi in carburo di tungsteno



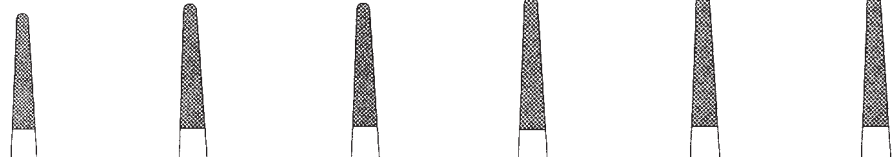
### HEGAR

<b>18-000-18</b>	18,0 cm, 7 "
<b>18-000-20</b>	20,0 cm, 8 "
<b>18-000-24</b>	24,0 cm, 9 ½ "



### MAYO-HEGAR

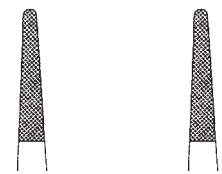
<b>18-002-14</b>	14,0 cm, 5 ½ "
<b>18-002-16</b>	16,0 cm, 6 ¼ "
<b>18-002-18</b>	18,0 cm, 7 "
<b>18-002-20</b>	20,0 cm, 8 "
<b>18-002-24</b>	24,0 cm, 9 ½ "
<b>18-002-26</b>	26,0 cm, 10 ¼ "
<b>18-002-30</b>	30,0 cm, 11 ¾ "
<b>18-002-36</b>	36,0 cm, 14 "
<b>18-002-40</b>	40,0 cm, 16 "



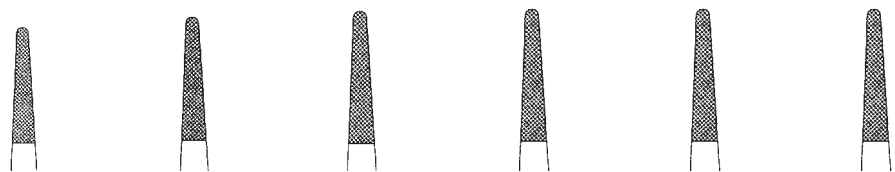
**18-004-15**      **18-004-16**      **18-004-18**      **18-004-20**      **18-004-23**      **18-004-26**

**DE BAKEY**

<b>18-004-15</b>	15,0 cm, 6 "
<b>18-004-16</b>	16,0 cm, 6 ¼ "
<b>18-004-18</b>	18,0 cm, 7 "
<b>18-004-20</b>	20,0 cm, 8 "
<b>18-004-23</b>	23,0 cm, 9 "
<b>18-004-26</b>	26,0 cm, 10 ¼ "
<b>18-004-31</b>	31,0 cm, 12 ½ "
<b>18-004-37</b>	37,0 cm, 14 ½ "



**18-004-31**      **18-004-37**

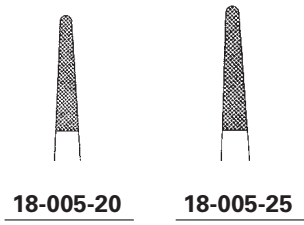


**18-012-15**      **18-012-18**      **18-012-20**      **18-012-23**      **18-012-36**      **18-012-40**

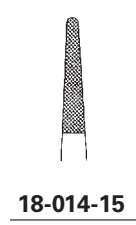


**CRILE-WOOD**

<b>18-012-15</b>	15,0 cm, 6 "
<b>18-012-18</b>	18,0 cm, 7 "
<b>18-012-20</b>	20,0 cm, 8 "
<b>18-012-23</b>	23,0 cm, 9 "
<b>18-012-36</b>	36,0 cm, 14 "
<b>18-012-40</b>	40,0 cm, 16 "



**18-005-20**      **18-005-25**



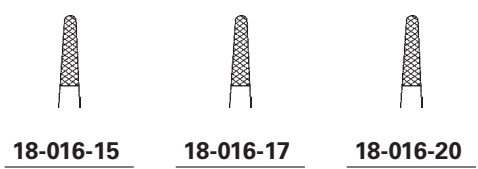
**18-014-15**

**DE BAKEY**

- 18-005-20**    20,0 cm, 8 "
- 18-005-25**    25,0 cm, 9 3/4 "

**BABY-CRILE-WOOD**

- 18-014-15**    15,0 cm, 6 "



**18-016-15**      **18-016-17**      **18-016-20**

**SENNING**

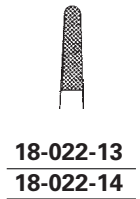
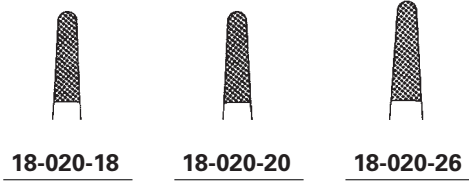
- 18-016-15**    15,0 cm, 6 "
- 18-016-17**    17,0 cm, 6 3/4 "
- 18-016-20**    20,0 cm, 8 "



**18-018-15**

**CRILE-WOOD**

- 18-018-15**    15,0 cm, 6 "

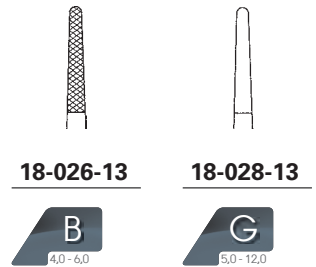


**SAROT**

18-020-18	18,0 cm, 7"
18-020-20	20,0 cm, 8"
18-020-26	26,0 cm, 10 1/4"

**HEGAR-BAUMGARTNER**

18-022-13	13,0 cm, 5 1/8"
18-022-14	14,0 cm, 5 1/2"



**NEIVERT-MASING**

18-024-13	13,0 cm, 5 1/8"
-----------	-----------------

**HALSEY**

18-026-13 - 18-028-13	13,0 cm, 5 1/8"
-----------------------	-----------------



**18-030-13**



**WEBSTER**

**18-030-13** 13,0 cm, 5 1/8"



**18-031-13**



**KILNER**

**18-031-13** 13,0 cm, 5 1/8"



**18-032-12**



**DERF**

**18-032-12** 12,0 cm, 4 3/4"



**18-034-12**



**DERF-CONVERSE**

**18-034-12** 12,0 cm, 4 3/4"



**18-036-13**



**18-036-15**

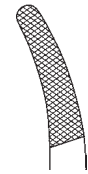


**18-036-13** 13,0 cm, 5 1/8"  
**18-036-15** 15,0 cm, 6"



**HEANEY**

<b>18-037-20</b>	20,0 cm, 8"
<b>18-037-24</b>	24,0 cm, 9 1/2"
<b>18-037-26</b>	26,0 cm, 10 1/4"
<b>18-037-36</b>	36,0 cm, 14 1/4"



<b>18-037-20</b>
<b>18-037-24</b>
<b>18-037-26</b>
<b>18-037-36</b>



**STRATTE**

<b>18-039-22</b>	22,0 cm, 8 3/4"
<b>18-039-23</b>	23,0 cm, 9"



**18-039-22**

**18-039-23**



**NEW ORLEANS**

<b>18-040-18</b>	18,0 cm, 7"
------------------	-------------



**18-040-18**



**BOZEMANN-S**

<b>18-041-20</b>	20,0 cm, 8"
<b>18-041-24</b>	24,0 cm, 9 1/2"
<b>18-041-26</b>	26,0 cm, 10 1/4"
<b>18-041-28</b>	28,0 cm, 11"



**18-041-20**

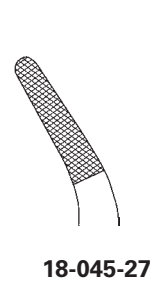
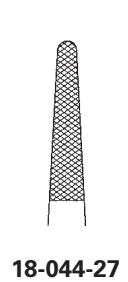
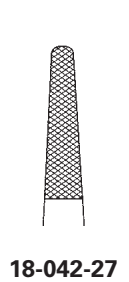
**18-041-24**



**18-041-26**

**18-041-28**





**MASSON**

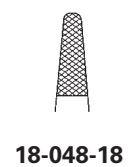
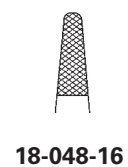
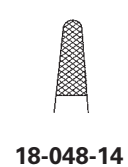
**18-042-27** 27,0 cm, 10<sup>3</sup>/<sub>4</sub>"

**WANGENSTEEN**

**18-044-27** 27,0 cm, 10<sup>3</sup>/<sub>4</sub>"

**FINOCHIETTO**

**18-045-27** 27,0 cm, 10<sup>3</sup>/<sub>4</sub>"



**OLSEN-HEGAR**

**18-046-12 - 17-046-13** 13,0 cm, 5<sup>1</sup>/<sub>8</sub>"

**OLSEN-HEGAR**

**18-048-14** 14,0 cm, 5<sup>1</sup>/<sub>2</sub>"

**18-048-16** 16,5 cm, 6<sup>1</sup>/<sub>2</sub>"

**18-048-18** 18,0 cm, 7"



**FOSTER-GILLIES**

**18-049-11** 11,0 cm, 4 3/8"



**GILLIES-MINI**

**18-051-15** 15,0 cm, 6"



**GILLIES**

**18-051-16** 16,0 cm, 6 1/4"

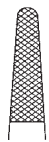


**MATHIEU**

**18-052-14** 14,0 cm, 5 1/2"

**18-052-17** 17,0 cm, 6 3/4"

**18-052-20** 20,0 cm, 8"



**18-052-17**



**18-052-20**



**MATHIEU**

**18-053-14** 14,0 cm, 5 1/2"

**18-053-17** 17,0 cm, 6 3/4"

**18-053-20** 20,0 cm, 8"



**18-053-14**

**18-053-17**



**18-053-20**



**Tc**  
TUNGSTEN



**18-053-21**



**18-053-25**

**MATHIEU**

- 18-053-21** 20,0 cm, 8"
- 18-053-25** 24,5 cm, 9 2/3"



**Tc**  
TUNGSTEN



**18-053-37**



**18-053-40**



**18-053-44**

**MATHIEU**

- 18-053-37** 17,0 cm, 6 3/4"
- 18-053-40** 20,0 cm, 8"
- 18-053-44** 24,0 cm, 9 1/2"



**Tc**  
TUNGSTEN



**18-054-14**



**18-054-17**



**18-054-20**

**MATHIEU**

- 18-054-14** 14,0 cm, 5 1/2"
- 18-054-17** 17,0 cm, 6 3/4"
- 18-054-20** 20,0 cm, 8"



**Tc**  
TUNGSTEN



**18-055-14**



**18-055-17**



**18-055-20**

**MATHIEU**

- 18-055-14** 14,0 cm, 5 1/2"
- 18-055-17** 17,0 cm, 6 3/4"
- 18-055-20** 20,0 cm, 8"



**Tc**  
TUNGSTEN

**18-056-20**



**Tc**  
TUNGSTEN

**18-057-20**



**18-057-26**

**A**  
0,6 - 4,0

**B**  
4,0 - 6,0

**LICHTENBERG**

**18-056-20** 20,0 cm, 8"

**18-057-20** 20,0 cm, 8"

**18-057-26** 26,0 cm, 10 1/4"



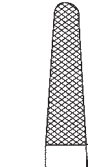
**Tc**  
TUNGSTEN

**18-058-26**



**Tc**  
TUNGSTEN

**18-066-20**



**18-066-23**

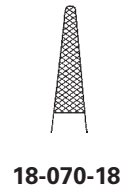
**HOESEL**

**18-058-26** 26,0 cm, 10 1/4"

**ZWEIFEL**

**18-066-20** 20,0 cm, 8"

**18-066-23** 23,0 cm, 9"



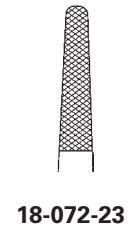
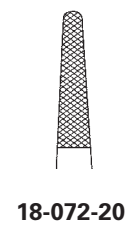
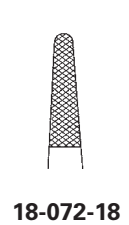
**TOENNIS**

**18-070-18** 18,0 cm, 7 "



**TOENNIS Modif.**

**18-071-18** 18,0 cm, 7 "



**LANGENBECK**

**18-072-18** 18,0 cm, 7 "

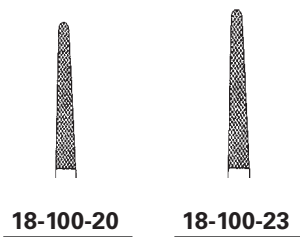
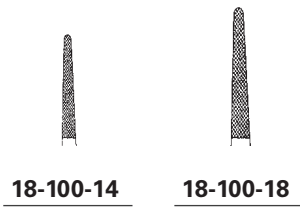
**18-072-20** 20,0 cm, 8 "

**18-072-23** 23,0 cm, 9 "



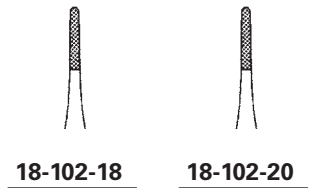
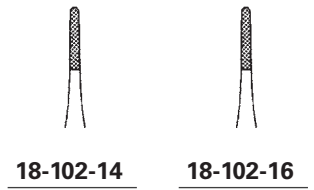
**ARRUGA**

**18-076-16 - 18-077-16** 16,0 cm, 6 2/8 "



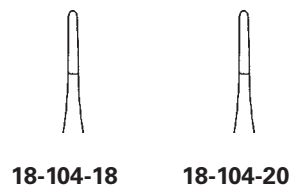
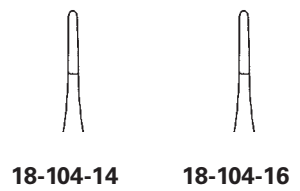
**HEGAR-VASCULAR**

<b>18-100-14</b>	14,0 cm, 5 1/2"
<b>18-100-18</b>	18,0 cm, 7"
<b>18-100-20</b>	20,0 cm, 8"
<b>18-100-23</b>	23,0 cm, 9"



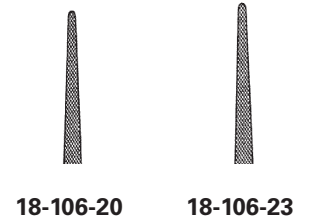
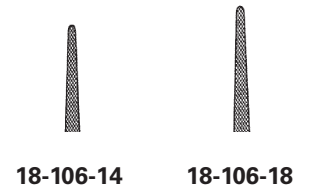
**HEGAR-VASCULAR**

<b>18-102-14</b>	14,0 cm, 5 1/2"
<b>18-102-16</b>	16,0 cm, 6 1/4"
<b>18-102-18</b>	18,0 cm, 7"
<b>18-102-20</b>	20,0 cm, 8"



**HEGAR-VASCULAR**

<b>18-104-14</b>	14,0 cm, 5 1/2"
<b>18-104-16</b>	16,0 cm, 6 1/4"
<b>18-104-18</b>	18,0 cm, 7"
<b>18-104-20</b>	20,0 cm, 8"
<b>18-104-23</b>	23,0 cm, 9"



**MICRO-VASCULAR**

<b>18-106-14</b>	14,0 cm, 5 1/2"
<b>18-106-18</b>	18,0 cm, 7"
<b>18-106-20</b>	20,0 cm, 8"
<b>18-106-23</b>	23,0 cm, 9"



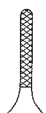
**B**  
4,0 - 6,0



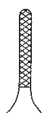
**Tc**  
TUNGSTEN

### RYDER-VASCULAR

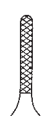
<b>18-110-13</b>	13,0 cm, 5 "
<b>18-110-15</b>	15,0 cm, 6 "
<b>18-110-18</b>	18,0 cm, 7 "
<b>18-110-20</b>	20,0 cm, 8 "
<b>18-110-23</b>	23,0 cm, 9 "
<b>18-110-26</b>	26,0 cm, 10 ½ "



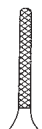
**18-110-13**



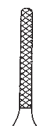
**18-110-15**



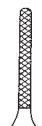
**18-110-18**



**18-110-20**



**18-110-23**



**18-110-26**

**C**  
5,0 - 12,0



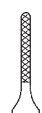
**Tc**  
TUNGSTEN

### MICRO-RYDER

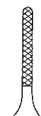
<b>18-112-13</b>	13,0 cm, 5 "
<b>18-112-15</b>	15,0 cm, 6 "
<b>18-112-18</b>	18,0 cm, 7 "
<b>18-112-20</b>	20,0 cm, 8 "
<b>18-112-23</b>	23,0 cm, 9 "
<b>18-112-26</b>	26,0 cm, 10 ½ "



**18-112-13**



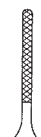
**18-112-15**



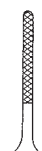
**18-112-18**



**18-112-20**



**18-112-23**



**18-112-26**

**C**  
5,0 - 12,0



**Tc**  
TUNGSTEN

### DIETRICH-VASCULAR

<b>18-116-16</b>	16,0 cm, 6 ¼ "
<b>18-116-18</b>	18,0 cm, 7 "
<b>18-116-20</b>	20,0 cm, 8 "
<b>18-116-23</b>	23,0 cm, 9 "
<b>18-116-26</b>	26,0 cm, 10 ½ "



**18-116-16**



**18-116-18**



**18-116-20**



**18-116-23**



**18-116-26**

**B**  
4,0 - 6,0



**Tc**  
TUNGSTEN



**18-120-14**



**18-120-17**



**18-120-20**

**B**  
4,0 - 6,0



**Tc**  
TUNGSTEN



**18-122-17**



**18-122-20**



**18-122-24**

**MATHIEU-RYDER**

<b>18-120-14</b>	14,0 cm, 5 1/2"
<b>18-120-17</b>	17,0 cm, 6 3/4"
<b>18-120-20</b>	20,0 cm, 8"

**MATHIEU-RYDER**

<b>18-122-17</b>	17,0 cm, 6 3/4"
<b>18-122-20</b>	20,0 cm, 8"
<b>18-122-24</b>	24,0 cm, 9 1/2"

**B**  
4,0 - 6,0



**Tc**  
TUNGSTEN



**18-130-20**

**LANGENBECK-RYDER**

<b>18-130-20</b>	20,0 cm, 8"
------------------	-------------



# 18

Mikro Instrumente  
Micro Instruments  
Instrumentos de micro  
Strumentario micro





20

Neurochirurgie

Neurosurgery

Neurocirugía

Neurochirurgia





# 20

Mikro Instrumente  
Micro Instruments  
Instrumentos de micro  
Strumentario micro



Kugelenkkloben zur Befestigung des Haltearms an OP-Tisch-Schienen  
 Ball and socket joint, to fixe holding device of operating table  
 Articulación esférica, para sujetar los brazos de apoyo sobre la mesa de operaciones  
 Giunto a sfera ad incastro, per il fissaggio dell'asta all'estremità del tavolo operatorio



**LEYLA**

**20-100-01** 10 x 25 mm

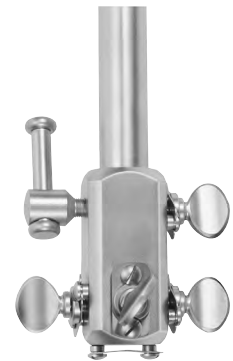
Haltearm  
 Holding device  
 Brazo  
 Porta asta



**LEYLA**

**20-100-02**

Kupplungskopf zur Aufnahme von 1-5 Spannarmen  
 Coupling head to hold 1-5 flexible arms  
 Acoplamiento para sujetar 1-5 brazos  
 Testa accoppiamento per 1-5 bracci flessibili



**LEYLA**

**20-100-03**

Kupplungskopf, drehbar zur Aufnahme von 1 Spannarm  
 Coupling head, rotatable to hold 1 flexible arm  
 Acoplamiento, girable para sujetar 1 brazo  
 Testa accoppiamento, girevole per 1 bracci flessibili



**LEYLA**

**20-100-04**

Kupplungskopf, seitlich offen zur Aufnahme von 1 Spannarm  
 Coupling head, lateral open to hold 1 flexible arm  
 Acoplamiento, laterale abierto para sujetar 1 brazo  
 Testa accoppiamento, laterale aperta per 1 bracci flessibili



**LEYLA**

**20-101-04**

Spannarm zum Aufstecken auf Kupplungsköpfe 20-100-03 | 20-100-04 | 20-101-04 und Fixiervorrichtungen

Flexible arm to be attached to coupling heads 20-100-03 | 20-100-04 | 20-101-04 and fixation device

Brazo para colocar sobre el acoplamiento 20-100-03 | 20-100-04 | 20-101-04 y los fijadores

Braccio flessibile per il fissaggio delle teste di accoppiamento 20-100-03 | 20-100-04 | 20-101-04 e le basi di fissaggio



**LEYLA**

**20-100-08**



Fixiervorrichtung für 1 Spannarm 20-100-08 zum Festschrauben am Schädel  
 Fixation device for 1 flexible arm 20-100-08 for skull mounting  
 Fijador para 1 brazo 20-100-08 para atornillar al cráneo  
 Base di fissaggio per 1 braccio flessibile 20-100-08 per il supporto del cranio



**LEYLEA**  
**20-100-05**

Fixiervorrichtung für 2 Spannarme 20-100-08 zum Festschrauben am Schädel  
 Fixation device for 2 flexible arms 20-100-08 for skull mounting  
 Fijador para 2 brazos 20-100-08 para atornillar al cráneo  
 Base di fissaggio per 2 bracci flessibile 20-100-08 per il supporto del cranio



**LEYLEA**  
**20-100-06**

Fixiervorrichtung für 1 Spannarm 20-100-08 zum Festschrauben an Rohrteilen  
 Fixation device for 1 flexible arm 20-100-08 for mounting to bars  
 Fijador para 1 brazo 20-100-08 para atornillar al tubos  
 Base di fissaggio per 1 braccio flessibile 20-100-08 per il supporto di asta di riccardo



**LEYLEA**  
**20-100-07** Ø 16,0 mm

Spatelhalter für flache Spatel zur Befestigung am Spannarm 20-100-08  
 Holding device for flat brain spatulas, to be fixed at holding device 20-100-08  
 Porta-espátula para espátulas planas, parasujetarlo al brazo 20-100-08  
 Supporto per spatola cervicale piatta, fissato al braccio flessibile 20-100-08



**LEYLEA**  
**20-100-09**

Spatelhalter für Rundschaft-Spatel zur Befestigung am Spannarm 20-100-08  
 Holding device for spatulas with round shaft, to be fixed at holding device 20-100-08  
 Porta-espátula con vástago redondo, parasujetarlo al brazo 20-100-08  
 Supporto per spatola craniale, fissato al braccio flessibile 20-100-08



**LEYLEA**  
**20-100-10** Ø 5,5 mm

Ohrtrichterhalter zur Befestigung am Spannarm 20-100-08  
 Ear specula holder, to be fixed at holding device 20-100-08  
 Soporte para espéculo, parasujetarlo al brazo 20-100-08  
 Sostegno per specchio, fissato al braccio flessibile 20-100-08



**LEYLEA**  
**20-100-13**



**LEYLA**

**20-100-11** SET

Selbsthaltender Hirnspatel mit 1 Spannarm komplett, bestehend aus:

Self-retaining brain retractor with 1 arm complete, consisting of:

1 Spannarm	<b>20-100-08</b>	1 Flexible arm	<b>20-100-08</b>
1 Fixiervorrichtung	<b>20-100-05</b>	1 Fixation device	<b>20-100-05</b>
1 Spatelhalter	<b>20-100-09</b>	1 Support for spatulas	<b>20-100-09</b>

Separador automático para el cerebro con 1 brazo, completo compuesto de:

Autofissatore per retrattore cervicale con 1 braccio, completo composto da:

1 Brazo, flexible	<b>20-100-08</b>	1 Braccio flessibile	<b>20-100-08</b>
1 Fijador	<b>20-100-05</b>	1 Base di fissaggio	<b>20-100-05</b>
1 Porta-espátula	<b>20-100-09</b>	1 Supporto per spatole	<b>20-100-09</b>

**LEYLA**

**20-100-12** SET

Selbsthaltender Hirnspatel mit 2 Spannarmen komplett, bestehend aus:

Self-retaining brain retractor with 2 arms complete, consisting of:

2 Spannarme	<b>20-100-08</b>	2 Flexible arms	<b>20-100-08</b>
1 Fixiervorrichtung	<b>20-100-06</b>	1 Fixation device	<b>20-100-06</b>
1 Spatelhalter	<b>20-100-09</b>	1 Support for spatulas	<b>20-100-09</b>

Separador automático para el cerebro con 2 brazos, completo compuesto de:

Autofissatore per retrattore cervicale con 2 bracci, completo composto da:

2 Brazo, flexible	<b>20-100-08</b>	2 Braccio flessibile	<b>20-100-08</b>
1 Fijador	<b>20-100-06</b>	1 Base di fissaggio	<b>20-100-06</b>
1 Porta-espátula	<b>20-100-09</b>	1 Supporto per spatole	<b>20-100-09</b>





<b>20-110-08</b>	7   8 mm
<b>20-110-11</b>	10   11 mm
<b>20-110-14</b>	13   14 mm
<b>20-110-17</b>	16   17 mm
<b>20-110-20</b>	19   20 mm
<b>20-110-25</b>	22   25 mm

biegsam  
malleable  
maleable  
malleabile

## HEIFETZ

**20-110-08 - 20-110-25** 20,0 cm, 8"



<b>20-115-08</b>	8 mm
<b>20-115-11</b>	11 mm
<b>20-115-14</b>	14 mm
<b>20-115-17</b>	17 mm

biegsam  
malleable  
maleable  
malleabile

## HEIFETZ

**20-115-08 - 20-115-17** 15,5 cm, 6 1/8"



<b>20-120-14</b>	14mm
<b>20-120-17</b>	17 mm
<b>20-120-20</b>	20 mm

biegsam  
malleable  
maleable  
malleabile

## HEIFETZ

**20-120-14 - 20-120-20** 20,0 cm, 8"



<b>20-122-07</b>	7   9 mm
<b>20-122-11</b>	11   13 mm
<b>20-122-15</b>	15   18 mm
<b>20-122-18</b>	18   22 mm

biegsam  
malleable  
maleable  
malleabile

## CUSHING

**20-122-07 - 20-122-18** 18,0 cm, 7"



<b>20-124-07</b>	7   9 mm
<b>20-124-11</b>	11   13 mm
<b>20-124-15</b>	15   18 mm
<b>20-124-18</b>	18   22 mm

konkav, biegsam  
concave, malleable  
cóncavas, maleable  
concave, malleabile



<b>20-125-07</b>	7   9 mm
<b>20-125-11</b>	11   13 mm
<b>20-125-15</b>	15   18 mm
<b>20-125-18</b>	18   22 mm

kovex, biegsam  
convex, malleable  
cónvexas, maleable  
convesse, malleabile

### OLIVECRONA

**20-124-07 - 20-124-18** 18,0 cm, 7"

### OLIVECRONA

**20-125-07 - 20-125-18** 18,0 cm, 7"



<b>20-125-29</b>	9 mm
<b>20-125-32</b>	12 mm
<b>20-125-34</b>	14 mm
<b>20-125-38</b>	18 mm
<b>20-125-40</b>	20 mm
<b>20-125-45</b>	25 mm

biegsam, aus spezieller MEMORY-Legierung, verformt sich bei der Sterilisation automatisch in den ursprünglich geraden Zustand

malleable, made of special MEMORY alloy, straightens out automatically during sterilisation process

flexible, Fabricado en una aleación especial MEMORY, recobra la forma recta original de forma automática durante la esterilización

pieghevole, realizzato in speciale lega a memoria di forma, che in seguito a sterilizzazione ritorna automaticamente alla forma diritta originaria



<b>16-074-01</b>	6 mm
<b>16-074-02</b>	8 mm
<b>16-074-03</b>	10 mm
<b>16-074-04</b>	12 mm
<b>16-074-05</b>	17 mm
<b>16-074-06</b>	25 mm

biegsam  
malleable  
maleable  
malleabile

### MEMORY

**20-125-29 - 20-125-45** 20,0 cm, 8"

**16-074-01 - 16-074-06** 20,0 cm, 8"



7,0 mm

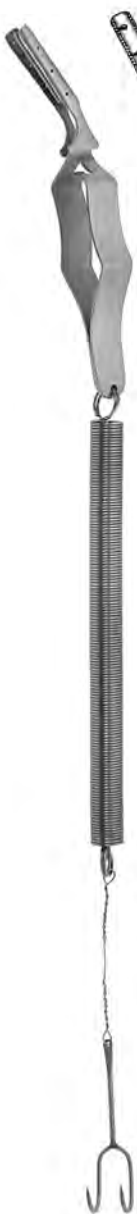
**20-126-07**

Federhaken zur Galea-Fixation mit Bulldog-Klemme zum Befestigen am Abdecktuch.

Spring hooks for galea fixation with bulldog clamp, to be fixed at covering drape.

Ganchos con muelle para la fijación de la galea, con pinza de bulldog para agarrar tela.

Ganci a molla per fissare la galea con clamp bulldog, da applicare al telo di copertura.



**YASARGIL**

**20-126-07** 31,0 cm, 12 1/4"



9,0 mm

**20-126-09**

Federhaken zur Galea-Fixation mit Bulldog-Klemme zum Befestigen am Abdecktuch.

Spring hooks for galea fixation with bulldog clamp, to be fixed at covering drape.

Ganchos con muelle para la fijación de la galea, con pinza de bulldog para agarrar tela.

Ganci a molla per fissare la galea con clamp bulldog, da applicare al telo di copertura.



**YASARGIL**

**20-126-09** 41,0 cm, 16 1/4"

Anlege- und Abnehmezange  
Applying and removing forceps  
Pinza para aplicar y quitar clips  
Pinza per applicare e togliere le agrafes



**RANEY**

**20-130-00** 16,0 cm, 6 1/4"



Verpackungseinheit: 1 St.  
Packing unit: 1 piece  
Unidad: 1 pieza  
Confezione: 1 pezza

Kopfhautklammern  
Scalp clips  
Pinza haemostática para cuero cabelludo  
Agrafes emostatici per cuoio capelluto



**RANEY**

**20-131-00**



Verpackungseinheit: 50 St.  
Packing unit: 50 pieces  
Unidad: 50 piezas  
Confezione: 50 pezzi

Kopfhautklammern  
Scalp clips  
Pinza haemostática para cuero cabelludo  
Agrafes emostatici per cuoio capelluto



**KOELNER**

**20-132-00**



Verpackungseinheit: 100 St.  
Packing unit: 100 pieces  
Unidad: 100 piezas  
Confezione: 100 pezzi

Silberklammern in Plastikbehälter  
Silver brain clips in plastic box  
Grapas de plata en tubo de plástico  
Agrafes di argento, contenuti in piccoli tubi



**MC KENZIE**

**20-133-00**

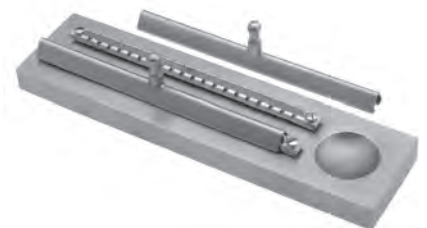
Silberklammernblock  
Silver clip carrier  
Porta-rapas  
Supporto porta-agrafes



**MC KENZIE**

**20-134-01** 148x40x6 mm

Silberklammernblock  
Silver clip carrier  
Porta-rapas  
Supporto porta-agrafes



**MC KENZIE**

**20-134-02** 190x48x13mm



**20-136-15**  
**20-136-19**

gerade  
 straight  
 recta  
 retta



**20-137-15**  
**20-137-19**

gebogen  
 curved  
 curva  
 curvo

Klammer Anlegezange für Silberklammern  
 Clip applying forceps for silver clips  
 Pinzas clipadoras para las grapas de plata  
 Pinze metti agrafes per agrafes in argento



**20-138-23**  
**20-138-26**

gerade  
 straight  
 recta  
 retta

Klammer Anlegezange für Silberklammern  
 Clip applying forceps for silver clips  
 Pinzas clipadoras para las grapas de plata  
 Pinze metti agrafes per agrafes in argento

### MC KENZIE

**20-136-15 - 20-137-15** 15,0 cm, 6"  
**20-136-19 - 20-137-19** 19,0 cm, 7 ½"

### SWEET

**20-138-23** 23,0 cm, 9"  
**20-138-26** 26,0 cm, 10 ¼"



**20-139-23**  
**20-139-26**

gebogen  
 curved  
 curva  
 curvo



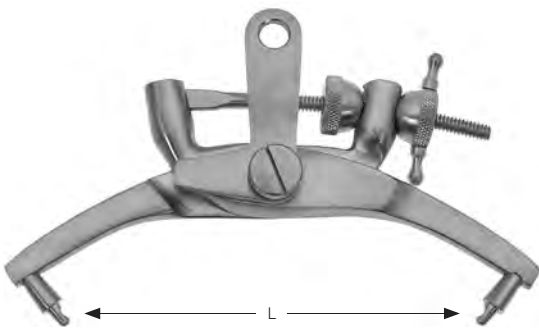
Klammer-Anlegezange für Silberklammern  
 Clip applying forceps for silver clips  
 Pinzas clipadoras para las grapas de plata  
 Pinze metti agrafes per agrafes in argento

### SMITHWICK

**20-139-23** 23,0 cm, 9"  
**20-139-26** 26,0 cm, 10 ¼"

### OLIVECRONA-TOENNIS

**20-140-14** 14,0 cm, 5 ½"



**CRUTCHFIELD**

**20-150-01** 10,5 cm, 4 1/4"



**CRUTCHFIELD**

**20-150-02** 15,5 cm, 6 1/8"



**20-151-00**

Ersatzdorn  
Spare pin  
Punta de requesto  
Punta di scorta

**CRUTCHFIELD**

**20-150-03** 17,5 cm, 7"

Schädelhalter für Extension der Halswirbel, großes Modell, Dorne verstellbar, deshalb vorbohren nicht erforderlich.

Cervical traction tongs, for extension of the neck vertebrae, large size, pins adjustable hence no initial drilling.

Pinza de tracción craneal para la extensión de las vertebrae de cuello, tamaño grande, puntas ajustables suprimiendo perforaciones iniciales.

Pinza per trazione craniale e l'estensione delle vertebre del collo, modello grande, punte regolabili al fine di evitare la perforazione iniziale.

Vorböhrer für CRUTCHFIELD-Schädelhalter  
Drill point for CRUTCHFIELD cervical traction tongs  
Perforador inicial pinzas de tracción craneal CRUTCHFIELD  
Alesatore per pinze di trazione craniale di CRUTCHFIELD



**CRUTCHFIELD**

**20-152-35** Ø 3,5 mm



**CRUTCHFIELD**

**20-152-50** Ø 5,0 mm



**DAHLGREN**

**20-154-20** 20,0 cm, 8 "



**DE VILBISS**

**20-156-21** 21,0 cm, 8 ¼ "



Schädelstanzzange bis 12 mm Schädelstärke  
Cranial punch rongeur for max. 12 mm of bone  
Pinza sca-bocados craneal para craneo hasta 12 mm  
Pinza per cranio, asta 12 mm

**CONE**

**20-156-22** 22,5 cm, 9 "



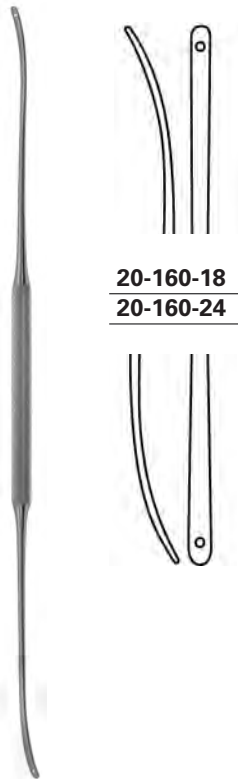
**DE MARTEL**

**20-158-33** 33,0 cm, 13 "



**LEBSCHE**

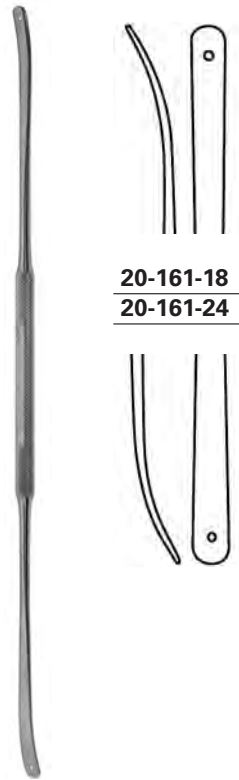
**20-159-25** 25,0 cm, 10 "



**20-160-18**  
**20-160-24**

**OLIVECRONA**

**20-160-18** 18,0 cm, 7 "  
**20-160-24** 24,0 cm, 9 ½ "



**20-161-18**  
**20-161-24**

**OLIVECRONA**

**20-161-19** 19,0 cm, 7 ¾ "  
**20-161-24** 24,0 cm, 9 ½ "



3,0 mm  
**20-163-03**

**SACHS**

**20-163-03** 21,0 cm, 8 ¼ "



6,0 mm  
**20-163-06**

**SACHS**

**20-163-06** 21,0 cm, 8 ¼ "



**20-164-18**

**SWEDISH**

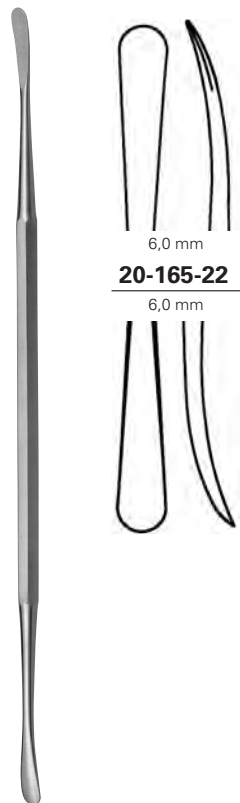
**20-164-18** 18,0 cm, 7 "



**20-164-20**

**SWEDISH**

**20-164-20** 20,0 cm, 8 "



6,0 mm  
**20-165-22**  
6,0 mm

**20-165-22** 22,0 cm, 8 ¾ "

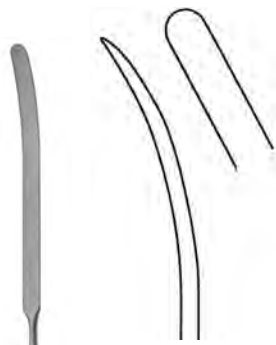


**20-167-21**

**MILLIGAN**

**20-167-21** 21,0 cm, 8 "





**20-169-21**

**SACHS**

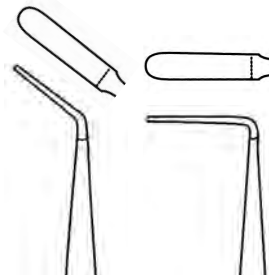
**20-169-21** 21,0 cm, 8 ¼ "



**20-170-01**

**FRAZIER**

**20-170-01** 15,0 cm, 6 "

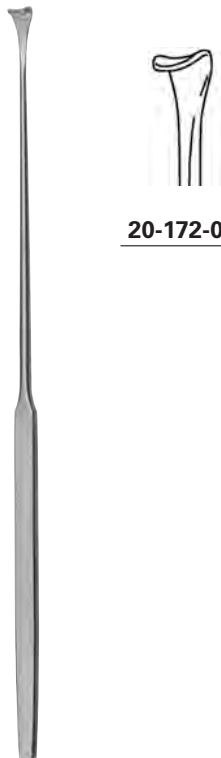


3,0 mm | 45°  
**20-170-02**

3,0 mm | 90°  
**20-170-03**

**HOEN**

**20-170-02 -20-170-03** 15,0 cm, 6 "



**20-172-01**

**LOVE**

**20-172-01** 20,0 cm, 8 "



45°  
**20-172-02**

**LOVE**

**20-172-02** 18,0 cm, 7 "



90°  
**20-172-03**

**LOVE**

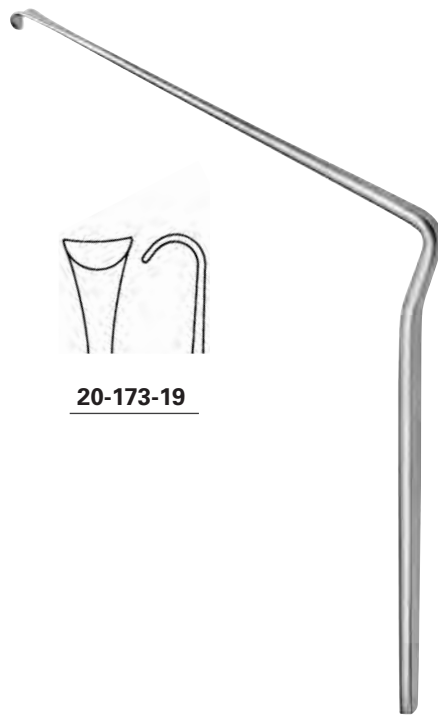
**20-172-03** 14,0 cm, 5 ½ "



**20-172-04**

**LOVE**

**20-172-04** 22,5 cm, 9"

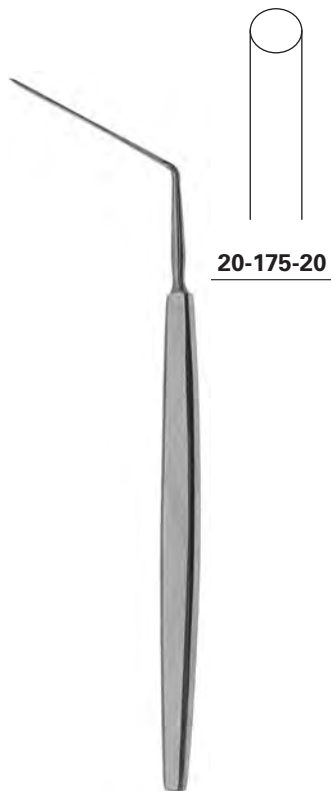


**20-173-19**

**CASPAR**

**20-174-04 - 20-174-10** 24,0 cm, 9 1/2"

<b>20-174-04</b>	4,0 mm
<b>20-174-06</b>	6,0 mm
<b>20-174-08</b>	8,0 mm
<b>20-174-10</b>	10,0 mm



**20-175-20**

**HORSLEY**

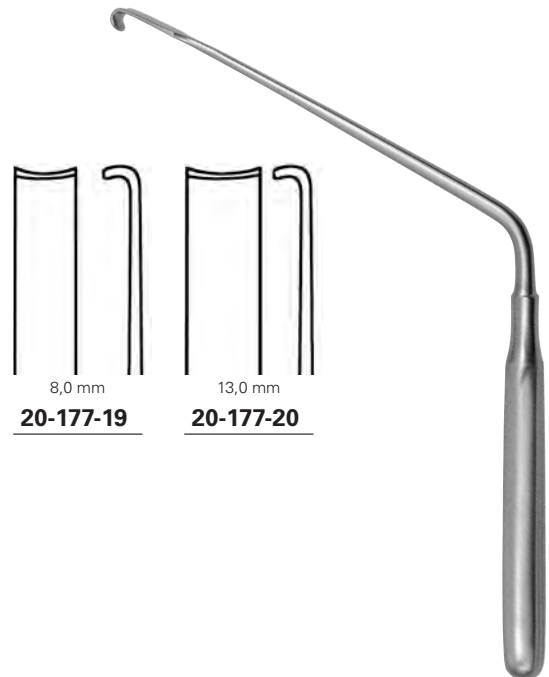
**20-175-20** 20,0 cm, 8"



**20-176-23**

**SCOVILLE**

**20-176-23** 23,0 cm, 9"

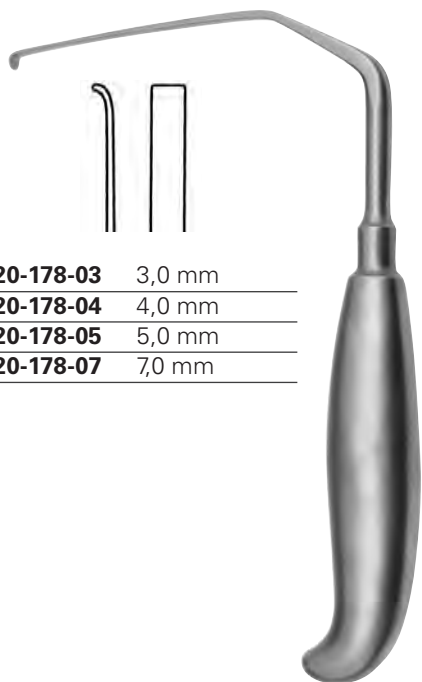


**20-177-19**

**20-177-20**

**SCOVILLE**

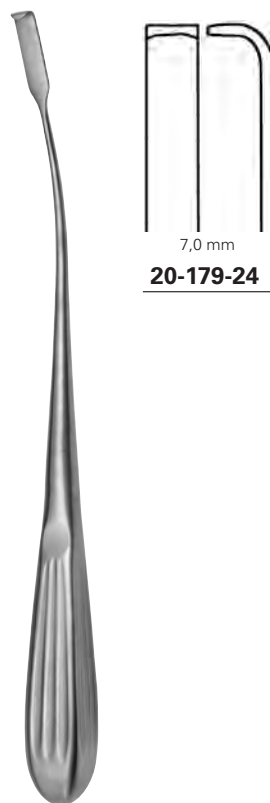
**20-177-19 - 20-177-20** 19,0 cm, 7 1/2"



<b>20-178-03</b>	3,0 mm
<b>20-178-04</b>	4,0 mm
<b>20-178-05</b>	5,0 mm
<b>20-178-07</b>	7,0 mm

### LOVE

**20-178-03 - 20-178-07** 11,0 cm, 4 3/8 "



7,0 mm  
**20-179-24**

### HOLSHER

**20-179-24** 24,0 cm, 9 1/2 "



<b>20-181-18</b>	18,0 mm
<b>20-181-20</b>	20,0 mm
<b>20-181-23</b>	23,0 mm

### CLOWARD

**20-181-18 - 20-181-23** 18,0 cm, 7 "



**20-182-20**  
 Duramesser  
 Dura knife  
 Cuchillo para dura-madré  
 Coltello per dura-madre

### HALLE

**20-182-20** 20,0 cm, 8 "



20-185-01



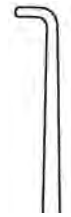
20-185-02



20-187-17



20-187-21



20-188-20

**GRONINGEN**

20-185-01 - 20-185-02 26,0 cm, 10 ¼"

**SMITHWICK**

20-187-17 17,0 cm, 6 ¾"

20-187-21 21,0 cm, 8 ¼"

**DANDY**

20-188-20 20,0 cm, 8"



20-189-20



20-190-20



20-191-16



20-192-18

**ADSON**

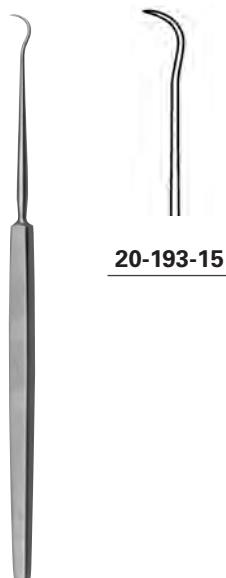
20-189-20 - 20-190-20 20,0 cm, 8"

**GRAHAM**

20-191-16 16,5 cm, 6 ½"

**SACHS**

20-192-18 18,5 cm, 7 ¼"



**20-193-15**

### TOENNIS

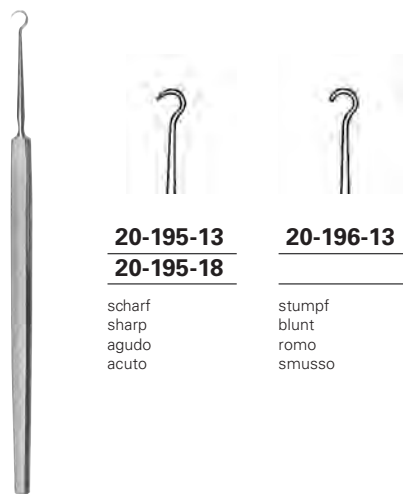
**20-193-15** 15,0 cm, 6 "



**20-194-14**

### CUSHING

**20-194-14** 14,0 cm, 5 ½ "



**20-195-13**  
**20-195-18**

scharf  
sharp  
agudo  
acuto

**20-196-13**

stumpf  
blunt  
romo  
smusso

### FRAZIER

**20-195-13 - 20-196-13** 13,0 cm, 5 ⅛ "  
**20-195-18** 18,0 cm, 7 "



**20-196-20**

### ADSON

**20-196-20** 20,0 cm, 8 "



max. Spreizweite 170 mm  
 max. spread 170 mm  
 apertura máxima 170 mm  
 apertura massima 170 mm

**SCOVILLE-RICHTER**

**20-300-00** SET

Komplett, bestehend aus:

1 Sperrer	<b>20-300-01</b>
1 Paar Seitenvälvn	<b>20-300-02</b>

Complete, consisting of:

1 Spreader	<b>20-300-01</b>
1 Pair lateral valves	<b>20-300-02</b>

Completo, compuesto de:

1 Separador	<b>20-300-01</b>
1 Par valvas laterales	<b>20-300-02</b>

Completo, composto da:

1 Divaricatore	<b>20-300-01</b>
1 Paio valve laterali	<b>20-300-02</b>



**SCOVILLE-RICHTER**  
**20-300-02**



**SCOVILLE-RICHTER**  
**20-300-03** 47 x 51 mm



**SCOVILLE-RICHTER**  
**20-300-04** 30 x 40 mm



**SCOVILLE-RICHTER**  
**20-300-05** 37 x 62 mm



max. Spreizweite 150 mm  
 max. spread 150 mm  
 apertura máxima 150 mm  
 apertura massima 150 mm

mit Gelenkarmen  
 with hinged arms  
 con brazos articulados  
 con braccio articolato

## SCOVILLE-HAVERFIELD

**20-302-00** SET

Komplett, bestehend aus:

Complete, consisting of:

1 Sperrer	<b>20-302-01</b>	1 Spreader	<b>20-302-01</b>
1 Haken 50 mm	<b>20-302-02</b>	1 Hook 50 mm	<b>20-302-02</b>
1 Seitenválve 64x25mm	<b>20-302-03</b>	1 Lateral valve 64x25mm	<b>20-302-03</b>

Completo, compuesto de:

Completo, composto da:

1 Separador	<b>20-302-01</b>	1 Divaricatore	<b>20-302-01</b>
1 Gancho 50 mm	<b>20-302-02</b>	1 Gancio 50 mm	<b>20-302-02</b>
1 Válvula laterales 64x25mm	<b>20-302-03</b>	1 Válvula laterale 64x25mm	<b>20-302-03</b>



stumpf  
 blunt  
 romo  
 smusso



### SCOVILLE

**20-302-02** 50 mm

### SCOVILLE

**20-302-03** 64 x 25 mm  
**20-302-04** 64 x 50 mm

### SCOVILLE

**20-302-05** 44 x 38 mm

### SCOVILLE

**20-302-06** 62 x 52 mm



max. Spreizweite 150 mm  
max. spread 150 mm  
apertura máxima 150 mm  
apertura massima 150 mm

**SCOVILLE**

**20-303-00** SET

Komplett, bestehend aus:

1 Sperrer	<b>20-303-01</b>
1 Haken 50 mm	<b>20-303-04</b>
1 Seitenvalve 64x25mm	<b>20-303-06</b>

Complete, consisting of:

1 Spreader	<b>20-303-01</b>
1 Hook 50 mm	<b>20-303-04</b>
1 Lateral valve 64x25mm	<b>20-303-06</b>

Completo, compuesto de:

1 Separador	<b>20-303-01</b>
1 Gancho 50 mm	<b>20-303-04</b>
1 Valva laterales 64x25mm	<b>20-303-06</b>

Completo, composto da:

1 Divaricatore	<b>20-303-01</b>
1 Gancio 50 mm	<b>20-303-04</b>
1 Valve laterale 64x25mm	<b>20-303-06</b>



stumpf  
blunt  
romo  
smusso

**SCOVILLE**

<b>20-303-02</b>	50 mm
<b>20-303-03</b>	70 mm



scharf  
sharp  
agudo  
acuto



**SCOVILLE**

<b>20-303-04</b>	50 mm
<b>20-303-05</b>	70 mm

**SCOVILLE**

<b>20-303-06</b>	64 x 25 mm
<b>20-303-07</b>	64 x 50 mm
<b>20-303-08</b>	88 x 25 mm

**TAYLOR**

<b>20-303-11</b>	48 x 50 mm
<b>20-303-12</b>	64 x 50 mm
<b>20-303-13</b>	64 x 64 mm
<b>20-303-14</b>	80 x 57 mm

**SCOVILLE**

<b>20-303-15</b>	41 x 38 mm
<b>20-303-16</b>	67 x 44 mm





Wundspreizer, Seitenvalven 50 x 43 mm  
Self-retaining retractor, lateral valves 50 x 43 mm  
Separador, vlvas laterales 50 x 43 mm  
Divaricatore, valve laterali 50 x 43 mm

max. Spreizweite 165 mm  
max. spread 165 mm  
apertura máxima 165 mm  
apertura massima 165 mm



## BAGDLEY

20-305-00



Messschieber zum Vermessen des  
Knochenspans und des Span-Situs  
Caliper, for measuring the bone  
graft and graft side

Pies de rey para medir esquirlas óseas y  
determinar la posición en el que se encuentran éstas  
Calibro per misurare innesti ossei  
e i relativi siti di innesto

## CASPAR

20-310-22 140 mm



### CASPAR

**20-313-00** SET

links  
left  
zurdo  
sinistra

Komplett, bestehend aus:

1 Distraktor, links	<b>20-315-01</b>
1 Bohrlehre, links	<b>20-318-00</b>
1 Bohrer, Ø 1,7 mm	<b>20-320-17</b>
2 Distraktionsschrauben	<b>20-315-16</b>
1 Schraubendreher	<b>20-322-20</b>

Complete, consisting of:

1 Distractor, left	<b>20-315-01</b>
1 Drill guide, left	<b>20-318-00</b>
1 Drill, Ø 1,7 mm	<b>20-320-17</b>
2 Distraction screws	<b>20-315-16</b>
1 Screw driver	<b>20-322-20</b>

Completo, compuesto de:

1 Distractor, zurdo	<b>20-315-01</b>
1 Guia-taladro, zurdo	<b>20-318-00</b>
1 Broca, Ø 1,7 mm	<b>20-320-17</b>
2 Tornillos de distraccion	<b>20-315-16</b>
1 Destornillador	<b>20-322-20</b>

Completo, composto da:

1 Distrattori, sinistra	<b>20-315-01</b>
1 Guida-trapano, sinistra	<b>20-318-00</b>
1 Trapano, Ø 1,7 mm	<b>20-320-17</b>
2 Viti di distrazione	<b>20-315-16</b>
1 Cacciavite	<b>20-322-20</b>



### CASPAR

**20-314-00** SET

rechts  
right  
derecho  
destra

Komplett, bestehend aus:

1 Distraktor, rechts	<b>20-315-00</b>
1 Bohrlehre, rechts	<b>20-317-00</b>
1 Bohrer, Ø 1,7 mm	<b>20-320-17</b>
2 Distraktionsschrauben	<b>20-315-16</b>
1 Schraubendreher	<b>20-322-20</b>

Complete, consisting of:

1 Distractor, right	<b>20-315-00</b>
1 Drill guide, right	<b>20-317-00</b>
1 Drill, Ø 1,7 mm	<b>20-320-17</b>
2 Distraction screws	<b>20-315-16</b>
1 Screw driver	<b>20-322-20</b>

Completo, compuesto de:

1 Distractor, derecho	<b>20-315-00</b>
1 Guia-taladro, derecho	<b>20-317-00</b>
1 Broca, Ø 1,7 mm	<b>20-320-17</b>
2 Tornillos de distraccion	<b>20-315-16</b>
1 Destornillador	<b>20-322-20</b>

Completo, composto da:

1 Distrattori, destra	<b>20-315-00</b>
1 Guida-trapano, destra	<b>20-317-00</b>
1 Trapano, Ø 1,7 mm	<b>20-320-17</b>
2 Viti di distrazione	<b>20-315-16</b>
1 Cacciavite	<b>20-322-20</b>

Bohrer zum Vorbohren  
 Drill for rough drilling  
 Broca para la perforación  
 Perforatore per la perforazione iniziale



### CASPAR

**20-320-17** Ø 1,7 mm



Distraktionsschrauben  
 Distraction screws  
 Tornillos de distraccion  
 Viti di distrazione

### CASPAR

**20-315-12** 12,0 mm

**20-315-14** 14,0 mm

**20-315-16** 16,0 mm

**20-315-18** 18,0 mm



rechts  
right  
derecho  
destra



**CASPAR**

**20-317-00**



links  
left  
zurdo  
sinistra



**CASPAR**

**20-318-00**



Schraubendreher  
Screw driver  
Destornillador  
Cacciavite



**CASPAR**

**20-322-20** 20,0 cm, 8 "



rechts  
right  
derecho  
destra

**CASPAR**

**20-315-00** kurz | short | corto | corto

**20-316-00** lang | long | largo | lungo



links  
left  
zurdo  
sinistra

**CASPAR**

**20-315-01** kurz | short | corto | corto

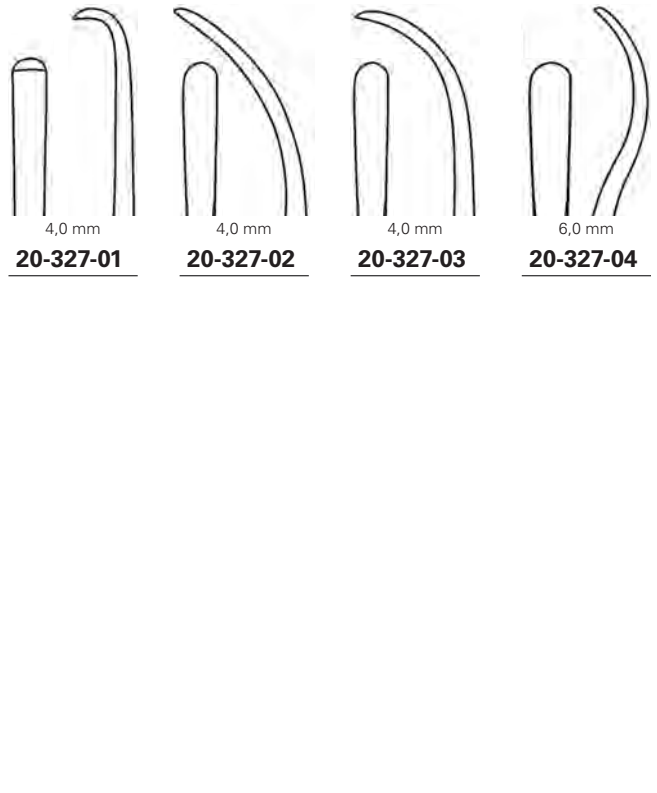
**20-316-01** lang | long | largo | lungo



4,7 mm  
**20-325-18**

**LANDOLT**

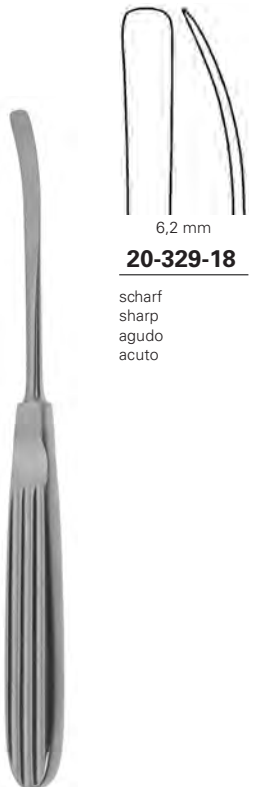
**20-325-18** 17,5 cm, 7 "



4,0 mm **20-327-01** 4,0 mm **20-327-02** 4,0 mm **20-327-03** 6,0 mm **20-327-04**

**MUEHLING**

**20-327-01 - 20-327-04** 17,0 cm, 6 ¾ "

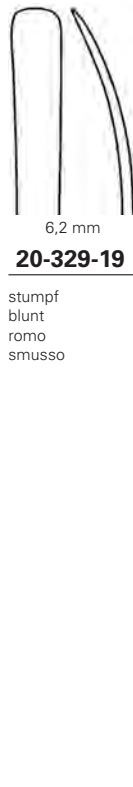


6,2 mm  
**20-329-18**

scharf  
sharp  
agudo  
acuto

**CASPAR**

**20-329-18** 18,0 cm, 7 "



6,2 mm  
**20-329-19**

stumpf  
blunt  
romo  
smusso

**CASPAR**

**20-329-19** 18,0 cm, 7 "



**20-331-01**



**20-331-02**



**CASPAR**

**20-331-01 - 20-331-02** 20,5 cm, 8 "



**20-331-01 P**



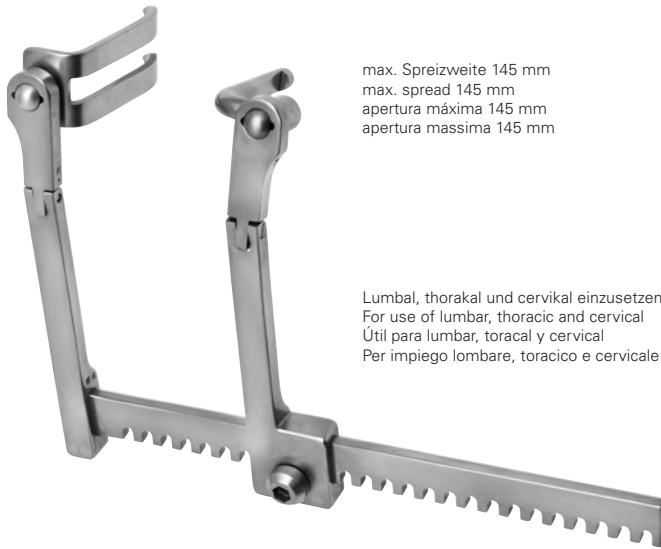
**20-331-02 P**



**CASPAR**

**20-331-01 P - 20-331-02 P** 20,5 cm, 8 "

Weitere Raspatorien finden Sie in in Produktgruppe 40.  
More raspatories you will find in product group 40.  
Encontrará más raspadores en el grupo de productos 40.  
Diversi periostotomi si trovano nel gruppo prodotti 40.



max. Spreizweite 145 mm  
max. spread 145 mm  
apertura máxima 145 mm  
apertura massima 145 mm

Lumbal, thorakal und cervical einzusetzen  
For use of lumbar, thoracic and cervical  
Útil para lumbar, toracal y cervical  
Per impiego lombare, toracico e cervicale

**CASPAR**

**20-350-00 SET**



Wundspreizer mit Gelenkarmen und Kugelschnellverschluss, für Laminektomie und Hemi-Laminektomie, komplett, bestehend aus:

1 Rahmen	<b>20-350-01</b>
1 Schlüssel	<b>20-350-02</b>
1 Haken, 38 mm	<b>20-351-13</b>
1 Seitenvalve, 37x22 mm	<b>20-352-37</b>
1 Seitenvalve, 43x22 mm	<b>20-352-43</b>
1 Seitenvalve, 47x22 mm	<b>20-352-47</b>
1 Seitenvalve, 52x22 mm	<b>20-352-52</b>
1 Seitenvalve, 57x22 mm	<b>20-352-57</b>

Self-retaining retractor with hinged arms and ball snap closure, for laminectomy and hemi-laminectomy, complete, consisting of:

1 Frame	<b>20-350-01</b>
1 Key	<b>20-350-02</b>
1 Hook, 38 mm	<b>20-351-13</b>
1 Lateral valve, 37x22 mm	<b>20-352-37</b>
1 Lateral valve, 43x22 mm	<b>20-352-43</b>
1 Lateral valve, 47x22 mm	<b>20-352-47</b>
1 Lateral valve, 52x22 mm	<b>20-352-52</b>
1 Lateral valve, 57x22 mm	<b>20-352-57</b>

Separador con brazos articulados y cierre rápido esférico, para laminectomía y hemilaminectomía, completo, compuesto de:

1 Cuadro	<b>20-350-01</b>
1 Llave	<b>20-350-02</b>
1 Gancho, 38 mm	<b>20-351-13</b>
1 Valva lateral, 37x22 mm	<b>20-352-37</b>
1 Valva lateral, 43x22 mm	<b>20-352-43</b>
1 Valva lateral, 47x22 mm	<b>20-352-47</b>
1 Valva lateral, 52x22 mm	<b>20-352-52</b>
1 Valva lateral, 57x22 mm	<b>20-352-57</b>

Divaricatore con braccio articolato a chiusura istantanea, per laminectomia e emi-laminectomia, completo, composto da:

1 Telaio	<b>20-350-01</b>
1 Chiave	<b>20-350-02</b>
1 Gancio, 38 mm	<b>20-351-13</b>
1 Valva laterale 37x22 mm	<b>20-352-37</b>
1 Valva laterale 43x22 mm	<b>20-352-43</b>
1 Valva laterale 47x22 mm	<b>20-352-47</b>
1 Valva laterale 52x22 mm	<b>20-352-52</b>
1 Valva laterale 57x22 mm	<b>20-352-57</b>



**20-351-13**  
38 mm



**20-352-37**  
37 x 22 mm



**20-352-43**  
43 x 22 mm



**20-352-47**  
47 x 22 mm



**20-352-52**  
52 x 22 mm



**20-352-57**  
57 x 22 mm

**20-350-02**



Pinzette zum Valvenwechsel bei Kugelschnellverschluß-System  
Forceps for changing valves with ball snap closure system  
Pinza para el cambio de valvas con el sistema de cierre rápido esférico  
Pinza per il cambio delle valve a chiusura istantanea



**20-358-99** 11,5 cm, 4 ½ "



Schlüssel  
Key  
llave  
Chiave



**20-350-02** 16,0 cm, 6 ¼ "



Haken mit Kugelschnellverschluss  
Hooks with ball snap closure  
Ganchos con cierre rápido esférico  
Ganci a chiusura istantanea



**20-351-13** 38 mm  
**20-351-15** 58 mm



Seitenvalven mit Kugelschnellverschluss  
Lateral valves with ball snap closure  
Valvas laterales con cierre rápido esférico  
Valve laterali a chiusura istantanea



**20-352-32** 32 x 22 mm  
**20-352-37** 37 x 22 mm  
**20-352-43** 43 x 22 mm  
**20-352-47** 47 x 22 mm  
**20-352-52** 52 x 22 mm  
**20-352-57** 57 x 22 mm  
**20-352-62** 62 x 22 mm  
**20-352-67** 67 x 22 mm



Seitenvalven mit Kugelschnellverschluss  
Lateral valves with ball snap closure  
Valvas laterales con cierre rápido esférico  
Valve laterali a chiusura istantanea



**20-353-32** 32 x 37 mm  
**20-353-37** 37 x 37 mm  
**20-353-43** 43 x 37 mm  
**20-353-47** 47 x 37 mm  
**20-353-52** 52 x 37 mm  
**20-353-57** 57 x 37 mm  
**20-353-62** 62 x 37 mm  
**20-353-67** 67 x 37 mm  
**20-353-70** 70 x 37 mm



Seitenvalven mit Kugelschnellverschluss  
Lateral valves with ball snap closure  
Valvas laterales con cierre rápido esférico  
Valve laterali a chiusura istantanea



**20-354-32** 32 x 52 mm  
**20-354-37** 37 x 52 mm  
**20-354-43** 43 x 52 mm  
**20-354-47** 47 x 52 mm  
**20-354-52** 52 x 52 mm  
**20-354-57** 57 x 52 mm  
**20-354-62** 62 x 52 mm  
**20-354-67** 67 x 52 mm  
**20-354-70** 70 x 52 mm



max. Spreizweite 145 mm  
max. spread 145 mm  
apertura máxima 145 mm  
apertura massima 145 mm

**CASPAR**

**20-350-10 SET**



Wundspreizer mit Kugelschnellver-  
schluß, für Laminektomie und Hemi-  
Laminektomie, komplett, bestehend  
aus:

1 Rahmen	<b>20-350-11</b>
1 Haken, 38 mm	<b>20-351-13</b>
1 Seitenvalve, 37x22 mm	<b>20-352-37</b>
1 Seitenvalve, 43x22 mm	<b>20-352-43</b>
1 Seitenvalve, 47x22 mm	<b>20-352-47</b>
1 Seitenvalve, 52x22 mm	<b>20-352-52</b>
1 Seitenvalve, 57x22 mm	<b>20-352-57</b>

Self-retaining retractor with ball snap  
closure, for laminectomy and hemi-  
laminectomy, complete, consisting of:

1 Frame	<b>20-350-11</b>
1 Hook, 38 mm	<b>20-351-13</b>
1 Lateral valve, 37x22 mm	<b>20-352-37</b>
1 Lateral valve, 43x22 mm	<b>20-352-43</b>
1 Lateral valve, 47x22 mm	<b>20-352-47</b>
1 Lateral valve, 52x22 mm	<b>20-352-52</b>
1 Lateral valve, 57x22 mm	<b>20-352-57</b>

Separador con cierre rápido esférico,  
para laminectomía y hemilaminectomía,  
completo, compuesto de:

Divaricatore con chiusura istantanea,  
per laminectomia e emi-laminectomia,  
completo, composto da:

1 Cuadro	<b>20-350-11</b>
1 Gancho, 38 mm	<b>20-351-13</b>
1 Valva lateral, 37x22 mm	<b>20-352-37</b>
1 Valva lateral, 43x22 mm	<b>20-352-43</b>
1 Valva lateral, 47x22 mm	<b>20-352-47</b>
1 Valva lateral, 52x22 mm	<b>20-352-52</b>
1 Valva lateral, 57x22 mm	<b>20-352-57</b>

1 Telaio	<b>20-350-11</b>
1 Gancio, 38 mm	<b>20-351-13</b>
1 Valva laterale 37x22 mm	<b>20-352-37</b>
1 Valva laterale 43x22 mm	<b>20-352-43</b>
1 Valva laterale 47x22 mm	<b>20-352-47</b>
1 Valva laterale 52x22 mm	<b>20-352-52</b>
1 Valva laterale 57x22 mm	<b>20-352-57</b>



**20-351-13**

38 mm

**20-352-37**

37 x 22 mm

**20-352-43**

43 x 22 mm

**20-352-47**

47 x 22 mm

**20-352-52**

52 x 22 mm

**20-352-57**

57 x 22 mm





Pinzette zum Valvenwechsel bei Kugel-  
schnellverschuß-System  
Forceps for changing valves with ball snap  
closure system  
Pinza para el cambio de valvas con el  
sistema de cierre rápido esférico  
Pinza per il cambio delle valve a chiusura  
istantanea



**20-358-99** 11,5 cm, 4 ½"



Haken mit Kugelschnellverschluss  
Hooks with ball snap closure  
Ganchos con cierre rápido esférico  
Ganci a chiusura istantanea



**20-351-13** 38 mm  
**20-351-15** 58 mm



Seitenvalven mit Kugelschnellverschluss  
Lateral valves with ball snap closure  
Valvas laterales con cierre rápido esférico  
Valve laterali a chiusura istantanea



<b>20-352-32</b>	32 x 22 mm
<b>20-352-37</b>	37 x 22 mm
<b>20-352-43</b>	43 x 22 mm
<b>20-352-47</b>	47 x 22 mm
<b>20-352-52</b>	52 x 22 mm
<b>20-352-57</b>	57 x 22 mm
<b>20-352-62</b>	62 x 22 mm
<b>20-352-67</b>	67 x 22 mm



Seitenvalven mit Kugelschnellverschluss  
Lateral valves with ball snap closure  
Valvas laterales con cierre rápido esférico  
Valve laterali a chiusura istantanea



<b>20-353-32</b>	32 x 37 mm
<b>20-353-37</b>	37 x 37 mm
<b>20-353-43</b>	43 x 37 mm
<b>20-353-47</b>	47 x 37 mm
<b>20-353-52</b>	52 x 37 mm
<b>20-353-57</b>	57 x 37 mm
<b>20-353-62</b>	62 x 37 mm
<b>20-353-67</b>	67 x 37 mm
<b>20-353-70</b>	70 x 37 mm



Seitenvalven mit Kugelschnellverschluss  
Lateral valves with ball snap closure  
Valvas laterales con cierre rápido esférico  
Valve laterali a chiusura istantanea



<b>20-354-32</b>	32 x 52 mm
<b>20-354-37</b>	37 x 52 mm
<b>20-354-43</b>	43 x 52 mm
<b>20-354-47</b>	47 x 52 mm
<b>20-354-52</b>	52 x 52 mm
<b>20-354-57</b>	57 x 52 mm
<b>20-354-62</b>	62 x 52 mm
<b>20-354-67</b>	67 x 52 mm
<b>20-354-70</b>	70 x 52 mm



max. Spreizweite 90 mm  
max. spread 90 mm  
apertura máxima 90 mm  
apertura massima 90 mm

Transversal zu verwenden  
To be used for transverse retraction  
Útil para retracción transversal  
Da impiegarsi per trazioni trasversali

**CASPAR**

**20-355-00** SET



Wundspreizer mit Gelenkarmen und Kugelschnellverschluß, komplett, bestehend aus:

1 Rahmen	<b>20-355-01</b>
1 Mediale Valve 40x23mm	<b>20-358-01</b>
1 Mediale Valve 45x23mm	<b>20-358-02</b>
1 Mediale Valve 50x23mm	<b>20-358-03</b>
1 Mediale Valve 55x23mm	<b>20-358-04</b>
1 Mediale Valve 60x23mm	<b>20-358-05</b>
1 Laterale Valve 40x23mm	<b>20-358-11</b>
1 Laterale Valve 45x23mm	<b>20-358-12</b>
1 Laterale Valve 50x23mm	<b>20-358-13</b>
1 Laterale Valve 55x23mm	<b>20-358-14</b>
1 Laterale Valve 60x23mm	<b>20-358-15</b>

Self-retaining retractor with hinged arms and ball snap closure, complete, consisting of:

1 Frame	<b>20-355-01</b>
1 Medial valve 40x23mm	<b>20-358-01</b>
1 Medial valve 45x23mm	<b>20-358-02</b>
1 Medial valve 50x23mm	<b>20-358-03</b>
1 Medial valve 55x23mm	<b>20-358-04</b>
1 Medial valve 60x23mm	<b>20-358-05</b>
1 Lateral valve 40x23mm	<b>20-358-11</b>
1 Lateral valve 45x23mm	<b>20-358-12</b>
1 Lateral valve 50x23mm	<b>20-358-13</b>
1 Lateral valve 55x23mm	<b>20-358-14</b>
1 Lateral valve 60x23mm	<b>20-358-15</b>

Separador con brazos articulados y cierre rápido esférico, completo, compuesto de:

1 Cuadro	<b>20-355-01</b>
1 Valva mediana 40x23mm	<b>20-358-01</b>
1 Valva mediana 45x23mm	<b>20-358-02</b>
1 Valva mediana 50x23mm	<b>20-358-03</b>
1 Valva mediana 55x23mm	<b>20-358-04</b>
1 Valva mediana 60x23mm	<b>20-358-05</b>
1 Valva lateral 40x23mm	<b>20-358-11</b>
1 Valva lateral 45x23mm	<b>20-358-12</b>
1 Valva lateral 50x23mm	<b>20-358-13</b>
1 Valva lateral 55x23mm	<b>20-358-14</b>
1 Valva lateral 60x23mm	<b>20-358-15</b>

Divaricatore con braccio articolato a chiusura istantanea, completo, composto da:

1 Telaio	<b>20-355-01</b>
1 Valva media 40x23mm	<b>20-358-01</b>
1 Valva media 45x23mm	<b>20-358-02</b>
1 Valva media 50x23mm	<b>20-358-03</b>
1 Valva media 55x23mm	<b>20-358-04</b>
1 Valva media 60x23mm	<b>20-358-05</b>
1 Valva laterale 40x23mm	<b>20-358-11</b>
1 Valva laterale 45x23mm	<b>20-358-12</b>
1 Valva laterale 50x23mm	<b>20-358-13</b>
1 Valva laterale 55x23mm	<b>20-358-14</b>
1 Valva laterale 60x23mm	<b>20-358-15</b>



**20-358-14**

**20-358-15**

55 x 23 mm

60 x 23 mm



**20-358-01**

**20-358-02**

**20-358-03**

**20-358-04**

**20-358-05**

**20-358-11**

**20-358-12**

**20-358-13**

40 x 23 mm

45 x 23 mm

50 x 23 mm

55 x 23 mm

60 x 23 mm

40 x 23 mm

45 x 23 mm

50 x 23 mm

Wundspreizer für die cervikale Wirbelsäule  
 Retractors for cervical spine  
 Separadores para la columna cervical  
 Divaricatori per colonna cervicale



max. Spreizweite 85 mm  
 max. spread 85 mm  
 apertura máxima 85 mm  
 apertura massima 85 mm

In Wirbelsäulen-Längsachse zu verwenden  
 To be used for outer line retraction  
 Útil para el eje longitudinal de la columna vertebra  
 Da impiegarsi per la trazioni e la compressione della colonna

**CASPAR**

**20-356-00** SET



Wundspreizer mit Gelenkarmen und Kugelschnellverschluß, komplett, bestehend aus:

1 Rahmen	<b>20-356-01</b>
1 Stumpfe Valve 45x23mm	<b>20-358-21</b>
1 Stumpfe Valve 50x23mm	<b>20-358-22</b>
1 Stumpfe Valve 55x23mm	<b>20-358-23</b>
1 Stumpfe Valve 60x23mm	<b>20-358-24</b>
1 Stumpfe Valve 65x23mm	<b>20-358-25</b>

Self-retaining retractor with hinged arms and ball snap closure, complete, consisting of:

1 Frame	<b>20-356-01</b>
1 Blunt valve 45x23mm	<b>20-358-21</b>
1 Blunt valve 50x23mm	<b>20-358-22</b>
1 Blunt valve 55x23mm	<b>20-358-23</b>
1 Blunt valve 60x23mm	<b>20-358-24</b>
1 Blunt valve 65x23mm	<b>20-358-25</b>

Separador con brazos articulados y cierre rápido esférico, completo, compuesto de:

1 Cuadro	<b>20-356-01</b>
1 Valva roma 45x23mm	<b>20-358-21</b>
1 Valva roma 50x23mm	<b>20-358-22</b>
1 Valva roma 55x23mm	<b>20-358-23</b>
1 Valva roma 60x23mm	<b>20-358-24</b>
1 Valva roma 65x23mm	<b>20-358-25</b>

Divaricatore con braccio articolato a chiusura istantanea, completo, composto da:

1 Telaio	<b>20-356-01</b>
1 Valva smussa 45x23mm	<b>20-358-21</b>
1 Valva smussa 50x23mm	<b>20-358-22</b>
1 Valva smussa 55x23mm	<b>20-358-23</b>
1 Valva smussa 60x23mm	<b>20-358-24</b>
1 Valva smussa 65x23mm	<b>20-358-25</b>



**20-358-21**

45 x 23 mm

**20-358-22**

50 x 23 mm

**20-358-23**

55 x 23 mm

**20-358-24**

60 x 23 mm

**20-358-25**

65 x 23 mm



max. Spreizweite 90 mm  
 max. spread 90 mm  
 apertura máxima 90 mm  
 apertura massima 90 mm

In Wirbelsäulen-Längsachse zu verwenden  
 To be used for outer line retraction  
 Útil para el eje longitudinal de la columna vertebra  
 Da impiegarsi per la trazioni e la compressione della colonna

**CASPAR**

**20-357-00** SET



Wundspreizer mit Gelenkarmen und Kugelschnellverschluß, komplett, bestehend aus:

1 Rahmen	<b>20-357-01</b>
1 Stumpfe Valve 45x23mm	<b>20-358-21</b>
1 Stumpfe Valve 50x23mm	<b>20-358-22</b>
1 Stumpfe Valve 55x23mm	<b>20-358-23</b>
1 Stumpfe Valve 60x23mm	<b>20-358-24</b>
1 Stumpfe Valve 65x23mm	<b>20-358-25</b>

Self-retaining retractor with hinged arms and ball snap closure, complete, consisting of:

1 Frame	<b>20-357-01</b>
1 Blunt valve 45x23mm	<b>20-358-21</b>
1 Blunt valve 50x23mm	<b>20-358-22</b>
1 Blunt valve 55x23mm	<b>20-358-23</b>
1 Blunt valve 60x23mm	<b>20-358-24</b>
1 Blunt valve 65x23mm	<b>20-358-25</b>

Separador con brazos articulados y cierre rápido esférico, completo, compuesto de:

1 Cuadro	<b>20-357-01</b>
1 Valva roma 45x23mm	<b>20-358-21</b>
1 Valva roma 50x23mm	<b>20-358-22</b>
1 Valva roma 55x23mm	<b>20-358-23</b>
1 Valva roma 60x23mm	<b>20-358-24</b>
1 Valva roma 65x23mm	<b>20-358-25</b>

Divaricatore con braccio articolato a chiusura istantanea, completo, composto da:

1 Telaio	<b>20-357-01</b>
1 Valva smussa 45x23mm	<b>20-358-21</b>
1 Valva smussa 50x23mm	<b>20-358-22</b>
1 Valva smussa 55x23mm	<b>20-358-23</b>
1 Valva smussa 60x23mm	<b>20-358-24</b>
1 Valva smussa 65x23mm	<b>20-358-25</b>



**20-358-21**

45 x 23 mm

**20-358-22**

50 x 23 mm

**20-358-23**

55 x 23 mm

**20-358-24**

60 x 23 mm

**20-358-25**

65 x 23 mm



## CCR

**20-358-00** SET



Cervikales Wirbelsäulen Retraktor Set,  
 bestehend aus:

Cervical spine retractor Set,  
 consisting of:

1 Draht-Siebschale	<b>55-191-07</b>
1 Silikon Nopenmatte	<b>55-855-00</b>
1 OP Tuch	<b>55-890-09</b>
1 Kennzeichnungsschild	<b>55-820-04</b>
1 Cervikal Sperrer	<b>20-355-01</b>
1 Cervikal Sperrer	<b>20-356-01</b>
1 Cervikal Gegensperrer	<b>20-357-01</b>
10 Stumpfe Valven, TITAN	<b>20-358-71 T - 20-358-80 T</b>
10 Mediale Valven, TITAN	<b>20-358-51 T - 20-358-60 T</b>
10 Laterale Valven, TITAN	<b>20-358-61 T - 20-358-70 T</b>
1 Blätterwechselfinzette	<b>20-358-99</b>

1 Wire basket	<b>55-191-07</b>
1 Silicone mat	<b>55-855-00</b>
1 OT towel	<b>55-890-09</b>
1 Identification label	<b>55-820-04</b>
1 Cervical retractor	<b>20-355-01</b>
1 Cervical retractor	<b>20-356-01</b>
1 Cervical counter retr.	<b>20-357-01</b>
10 Blunt valves, TITANIUM	<b>20-358-71 T - 20-358-80 T</b>
10 Medial valves, TITANIUM	<b>20-358-51 T - 20-358-60 T</b>
10 Lateral valves, TITANIUM	<b>20-358-61 T - 20-358-70 T</b>
1 Valve changing forceps	<b>20-358-99</b>

Columna vertebral Separador Set,  
 compuesto de:

Columna vertebral Separador Set,  
 compuesto de:

1 Cesta de alambre	<b>55-191-07</b>
1 Soportes de silicona	<b>55-855-00</b>
1 Paño	<b>55-890-09</b>
1 Placa de identificación	<b>55-820-04</b>
1 Separador cervical	<b>20-355-01</b>
1 Separador cervical	<b>20-356-01</b>
1 Cervical contraseparador	<b>20-357-01</b>
10 Valvas romas, TITAN	<b>20-358-71 T - 20-358-80 T</b>
10 Valvas mediales, TITAN	<b>20-358-51 T - 20-358-60 T</b>
10 Valvas laterales, TITAN	<b>20-358-61 T - 20-358-70 T</b>
1 Pinza para valvas	<b>20-358-99</b>

1 Castello in rete metallica	<b>55-191-07</b>
1 Suppórtui in silicone	<b>55-855-00</b>
1 Tessuto	<b>55-890-09</b>
1 Targhette di identification	<b>55-820-04</b>
1 Cervical divaricatori	<b>20-355-01</b>
1 Cervical divaricatori	<b>20-356-01</b>
1 Cerv. contro divaricatori	<b>20-357-01</b>
10 Valve smusse, TITAN	<b>20-358-71 T - 20-358-80 T</b>
10 Valve medie, TITAN	<b>20-358-51 T - 20-358-60 T</b>
10 Valve laterali, TITAN	<b>20-358-61 T - 20-358-70 T</b>
1 Pinza per valve	<b>20-358-99</b>



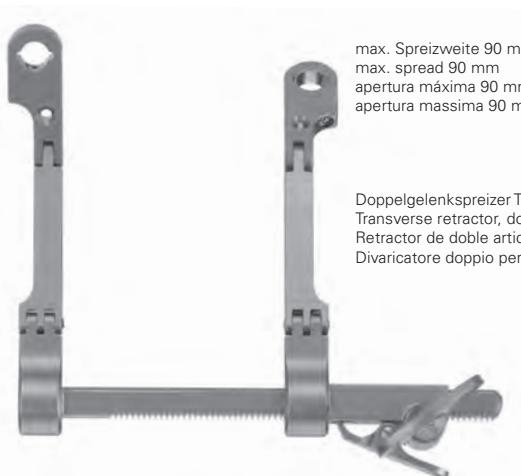
max. Spreizweite 90 mm  
 max. spread 90 mm  
 apertura máxima 90 mm  
 apertura massima 90 mm

**CASPAR**  
 20-355-01



max. Spreizweite 90 mm  
 max. spread 90 mm  
 apertura máxima 90 mm  
 apertura massima 90 mm

**CASPAR**  
 20-355-01 T



max. Spreizweite 90 mm  
 max. spread 90 mm  
 apertura máxima 90 mm  
 apertura massima 90 mm

Doppelgelenkspreizer Transversal  
 Transverse retractor, double hinged  
 Retractor de doble articulación, transversal  
 Divaricatore doppio per articolazione trasversale

**CASPAR**  
 20-355-10



max. Spreizweite 85 mm  
 max. spread 85 mm  
 apertura máxima 85 mm  
 apertura massima 85 mm

**CASPAR**  
 20-356-01





max. Spreizweite 90 mm  
max. spread 90 mm  
apertura máxima 90 mm  
apertura massima 90 mm

**CASPAR**  
20-357-01



max. Spreizweite 90 mm  
max. spread 90 mm  
apertura máxima 90 mm  
apertura massima 90 mm

**CASPAR**  
20-357-01 T



max. Spreizweite 90 mm  
max. spread 90 mm  
apertura máxima 90 mm  
apertura massima 90 mm

Doppelgelenkspreizer Transversal  
Transverse retractor, double hinged  
Retractor de doble articulación, transversal  
Divaricatore doppio per articolazione trasversale

**CASPAR**  
20-357-10





Mediale Valven mit Kugelschnellverschluss  
Medial valves with ball snap closure  
Valvas mediales con cierre rápido esférico  
Valve medie a chiusura istantanea



<b>20-358-01</b>	40 x 23 mm
<b>20-358-02</b>	45 x 23 mm
<b>20-358-03</b>	50 x 23 mm
<b>20-358-04</b>	55 x 23 mm
<b>20-358-05</b>	60 x 23 mm



Laterale Valven mit Kugelschnellverschluss  
Lateral valves with ball snap closure  
Valvas laterales con cierre rápido esférico  
Valve laterali a chiusura istantanea



<b>20-358-11</b>	40 x 23 mm
<b>20-358-12</b>	45 x 23 mm
<b>20-358-13</b>	50 x 23 mm
<b>20-358-14</b>	55 x 23 mm
<b>20-358-15</b>	60 x 23 mm



Stumpfe Valven mit Kugelschnellverschluss  
Blunt valves with ball snap closure  
Valvas romas con cierre rápido esférico  
Valve smusse a chiusura istantanea



<b>20-358-21</b>	45 x 23 mm
<b>20-358-22</b>	50 x 23 mm
<b>20-358-23</b>	55 x 23 mm
<b>20-358-24</b>	60 x 23 mm
<b>20-358-25</b>	65 x 23 mm



Stumpfe Valven mit Kugelschnellverschluss  
Blunt valves with ball snap closure  
Valvas romas con cierre rápido esférico  
Valve smusse a chiusura istantanea



<b>20-358-31</b>	50 x 25 mm
<b>20-358-32</b>	60 x 25 mm



Mediale Valven mit Kugelschnellverschluss  
Medial valves with ball snap closure  
Valvas mediales con cierre rápido esférico  
Valve medie a chiusura istantanea



<b>20-358-51 T</b>	25 x 24 mm
<b>20-358-52 T</b>	30 x 24 mm
<b>20-358-53 T</b>	35 x 24 mm
<b>20-358-54 T</b>	40 x 24 mm
<b>20-358-55 T</b>	45 x 24 mm
<b>20-358-56 T</b>	50 x 24 mm
<b>20-358-57 T</b>	55 x 24 mm
<b>20-358-58 T</b>	60 x 24 mm
<b>20-358-59 T</b>	65 x 24 mm
<b>20-358-60 T</b>	70 x 24 mm



Laterale Valven mit Kugelschnellverschluss  
Lateral valves with ball snap closure  
Valvas laterales con cierre rápido esférico  
Valve laterali a chiusura istantanea



<b>20-358-61 T</b>	25 x 24 mm
<b>20-358-62 T</b>	30 x 24 mm
<b>20-358-63 T</b>	35 x 24 mm
<b>20-358-64 T</b>	40 x 24 mm
<b>20-358-65 T</b>	45 x 24 mm
<b>20-358-66 T</b>	50 x 24 mm
<b>20-358-67 T</b>	55 x 24 mm
<b>20-358-68 T</b>	60 x 24 mm
<b>20-358-69 T</b>	65 x 24 mm
<b>20-358-70 T</b>	70 x 24 mm



Stumpfe Valven mit Kugelschnellverschluss  
Blunt valves with ball snap closure  
Valvas romas con cierre rápido esférico  
Valve smusse a chiusura istantanea



<b>20-358-71 T</b>	30 x 24 mm
<b>20-358-72 T</b>	35 x 24 mm
<b>20-358-73 T</b>	40 x 24 mm
<b>20-358-74 T</b>	45 x 24 mm
<b>20-358-75 T</b>	50 x 24 mm
<b>20-358-76 T</b>	55 x 24 mm
<b>20-358-77 T</b>	60 x 24 mm
<b>20-358-78 T</b>	65 x 24 mm
<b>20-358-79 T</b>	70 x 24 mm
<b>20-358-80 T</b>	75 x 24 mm



Wundspreizer für die cervikale Wirbelsäule  
 Retractors for cervical spine  
 Separadores para la columna cervical  
 Divaricatori per colonna cervicale



Mediale Valven mit Kugelschnellverschluss  
 Medial valves with ball snap closure  
 Valvas mediales con cierre rápido esférico  
 Valve medie a chiusura istantanea



<b>20-358-51 ST</b>	25 x 25 mm
<b>20-358-52 ST</b>	30 x 25 mm
<b>20-358-53 ST</b>	35 x 25 mm
<b>20-358-54 ST</b>	40 x 25 mm
<b>20-358-55 ST</b>	45 x 25 mm
<b>20-358-56 ST</b>	50 x 25 mm
<b>20-358-57 ST</b>	55 x 25 mm
<b>20-358-58 ST</b>	60 x 25 mm
<b>20-358-59 ST</b>	65 x 25 mm
<b>20-358-60 ST</b>	70 x 25 mm



Laterale Valven mit Kugelschnellverschluss  
 Lateral valves with ball snap closure  
 Valvas laterales con cierre rápido esférico  
 Valve laterali a chiusura istantanea



<b>20-358-61 ST</b>	25 x 25 mm
<b>20-358-62 ST</b>	30 x 25 mm
<b>20-358-63 ST</b>	35 x 25 mm
<b>20-358-64 ST</b>	40 x 25 mm
<b>20-358-65 ST</b>	45 x 25 mm
<b>20-358-66 ST</b>	50 x 25 mm
<b>20-358-67 ST</b>	55 x 25 mm
<b>20-358-68 ST</b>	60 x 25 mm
<b>20-358-69 ST</b>	65 x 25 mm
<b>20-358-70 ST</b>	70 x 25 mm



Pinzette zum Valvenwechsel bei Kugel-  
 schnellverschluss-System  
 Forceps for changing the valves with ball  
 snap closure system  
 Pinza para el cambio de valvas con el  
 sistema de cierre rápido esférico  
 Pinza per il cambio delle valve a chiusura  
 istantanea



**20-358-99** 11,5 cm, 4 1/2"

Maßangaben für Blattgrößen  
 Dimesions for blade sizes  
 Datos sobre las dimensiones de cada tamaño de hoja  
 Indicazioni sulle misure delle valve



**20-358-14** 55 x 23 mm

Valven mit Kugelschnellverschluss für Wundspreizer:  
 Valves with ball snap closure for self retaining retractors:  
 Valvas con cierre rápido esférico para seperadores:  
 Valve a chiusura istantanea per divaricatori:

20-350-01  
 20-355-01  
 20-355-01 T  
 20-355-10  
 20-356-01  
 20-357-01  
 20-357-01 T  
 20-357-10





max. Spreizweite 90 mm  
 max. spread 90 mm  
 apertura máxima 90 mm  
 apertura massima 90 mm

PK  
PEEK

**CASPAR**  
 20-355-01 P



STEEL  
STAINLESS



max. Spreizweite 90 mm  
 max. spread 90 mm  
 apertura máxima 90 mm  
 apertura massima 90 mm

Doppelgelenkspreizer Transversal  
 Transverse retractor, double hinged  
 Retractor de doble articulación, transversal  
 Divaricatore doppio per articolazione trasversale

PK  
PEEK

**CASPAR**  
 20-355-10 P



STEEL  
STAINLESS



max. Spreizweite 90 mm  
 max. spread 90 mm  
 apertura máxima 90 mm  
 apertura massima 90 mm

PK  
PEEK

**CASPAR**  
 20-357-01 P



STEEL  
STAINLESS



max. Spreizweite 90 mm  
 max. spread 90 mm  
 apertura máxima 90 mm  
 apertura massima 90 mm

Doppelgelenkspreizer Transversal  
 Transverse retractor, double hinged  
 Retractor de doble articulación, transversal  
 Divaricatore doppio per articolazione trasversale

PK  
PEEK

**CASPAR**  
 20-357-10 P



STEEL  
STAINLESS



max. Spreizweite 85 mm  
 max. spread 85 mm  
 apertura máxima 85 mm  
 apertura massima 85 mm

**CASPAR**

**20-356-01 P**



Handgriff für Valven  
 Handle for valves  
 Asa para valvas  
 Impugnatura per valvola

**20-358-98 P**



Mediale Valven mit Kugelschnellverschluss  
 Medial valves with ball snap closure  
 Valvas mediales con cierre rápido esférico  
 Valve medie a chiusura istantanea



Laterale Valven mit Kugelschnellverschluss  
 Lateral valves with ball snap closure  
 Valvas laterales con cierre rápido esférico  
 Valve laterali a chiusura istantanea



Laterale Valven mit Kugelschnellverschluss  
 Lateral valves with ball snap closure  
 Valvas laterales con cierre rápido esférico  
 Valve laterali a chiusura istantanea



Stumpfe Valven mit Kugelschnellverschluss  
 Blunt valves with ball snap closure  
 Valvas romas con cierre rápido esférico  
 Valve smusse a chiusura istantanea



**20-358-01 P** 40 x 23 mm

**20-358-02 P** 45 x 23 mm

**20-358-03 P** 50 x 23 mm

**20-358-04 P** 55 x 23 mm

**20-358-05 P** 60 x 23 mm

**20-358-06 P** 65 x 23 mm

**20-358-08 P** 75 x 23 mm

**20-358-11 P** 40 x 23 mm

**20-358-12 P** 45 x 23 mm

**20-358-13 P** 50 x 23 mm

**20-358-14 P** 55 x 23 mm

**20-358-15 P** 60 x 23 mm

**20-358-16 P** 65 x 23 mm

**20-358-18 P** 75 x 23 mm

**20-358-41 P** 40 x 12 mm

**20-358-42 P** 45 x 12 mm

**20-358-43 P** 50 x 12 mm

**20-358-44 P** 55 x 12 mm

**20-358-45 P** 60 x 12 mm

**20-358-21 P** 40 x 23 mm

**20-358-22 P** 45 x 23 mm

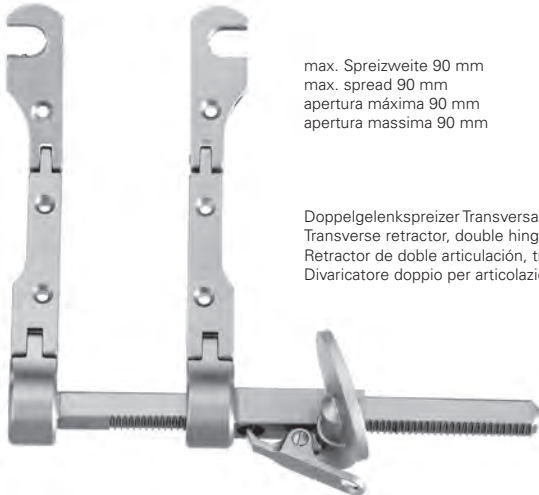
**20-358-23 P** 50 x 23 mm

**20-358-24 P** 55 x 23 mm

**20-358-25 P** 60 x 23 mm

**20-358-26 P** 65 x 23 mm

**20-358-28 P** 75 x 23 mm



max. Spreizweite 90 mm  
 max. spread 90 mm  
 apertura máxima 90 mm  
 apertura massima 90 mm

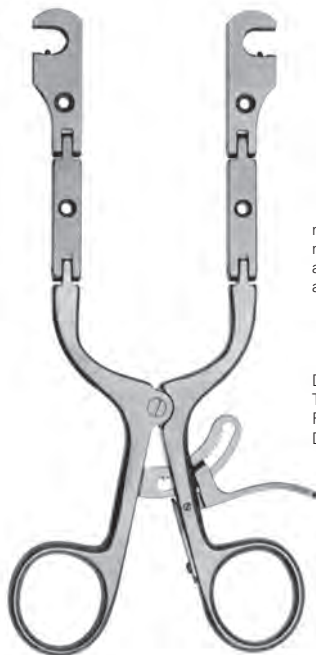
Doppelgelenkspreizer Transversal  
 Transverse retractor, double hinged  
 Retractor de doble articulación, transversal  
 Divaricatore doppio per articolazione trasversale

**CASPAR-QC**  
 20-355-10 QC



max. Spreizweite 85 mm  
 max. spread 85 mm  
 apertura máxima 85 mm  
 apertura massima 85 mm

**CASPAR-QC**  
 20-356-01 QC



max. Spreizweite 90 mm  
 max. spread 90 mm  
 apertura máxima 90 mm  
 apertura massima 90 mm

Doppelgelenkspreizer Transversal  
 Transverse retractor, double hinged  
 Retractor de doble articulación, transversal  
 Divaricatore doppio per articolazione trasversale

**CASPAR-QC**  
 20-357-10 QC



Einsetzinstrument für QC Valven  
 QC valve inserter  
 Introducitor para valvas QC  
 Strumenti per inserzione di valve QC

**CASPAR-QC**  
 20-357-60 QC 18,5 cm, 7 "





Mediale Valven mit QC-Verschluss  
 Medial valves with QC-closure  
 Valvas mediales con cierre QC  
 Valve medie a chiusura QC



**QC**

- 20-359-31 T** 25 x 19 mm
- 20-359-32 T** 30 x 19 mm
- 20-359-33 T** 35 x 19 mm
- 20-359-34 T** 40 x 19 mm
- 20-359-35 T** 45 x 19 mm
- 20-359-36 T** 50 x 19 mm
- 20-359-37 T** 55 x 19 mm
- 20-359-38 T** 60 x 19 mm



Stumpfe Valven mit QC-Verschluss  
 Blunt valves with QC-closure  
 Valvas romas con cierre QC  
 Valve smusse a chiusura QC



**QC**

- 20-359-41 T** 25 x 19 mm
- 20-359-42 T** 30 x 19 mm
- 20-359-43 T** 35 x 19 mm
- 20-359-44 T** 40 x 19 mm
- 20-359-45 T** 45 x 19 mm
- 20-359-46 T** 50 x 19 mm
- 20-359-47 T** 55 x 19 mm
- 20-359-48 T** 60 x 19 mm

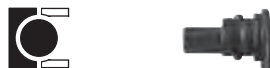


Mediale Valven mit QC-Verschluss  
 Medial valves with QC-closure  
 Valvas mediales con cierre QC  
 Valve medie a chiusura QC



**QC**

- 20-359-51 T** 30 x 24 mm
- 20-359-52 T** 35 x 24 mm
- 20-359-53 T** 40 x 24 mm
- 20-359-54 T** 45 x 24 mm
- 20-359-55 T** 50 x 24 mm
- 20-359-56 T** 55 x 24 mm
- 20-359-57 T** 60 x 24 mm
- 20-359-58 T** 65 x 24 mm
- 20-359-59 T** 70 x 24 mm



Laterale Valven mit QC-Verschluss  
 Lateral valves with QC-closure  
 Valvas laterales con cierre QC  
 Valve laterali a chiusura QC



**QC**

- 20-359-61 T** 30 x 24 mm
- 20-359-62 T** 35 x 24 mm
- 20-359-63 T** 40 x 24 mm
- 20-359-64 T** 45 x 24 mm
- 20-359-65 T** 50 x 24 mm
- 20-359-66 T** 55 x 24 mm
- 20-359-67 T** 60 x 24 mm
- 20-359-68 T** 65 x 24 mm
- 20-359-69 T** 70 x 24 mm



Stumpfe Valven mit QC-Verschluss  
 Blunt valves with QC-closure  
 Valvas romas con cierre QC  
 Valve smusse a chiusura QC



**QC**

- 20-359-71 T** 30 x 24 mm
- 20-359-72 T** 35 x 24 mm
- 20-359-73 T** 40 x 24 mm
- 20-359-74 T** 45 x 24 mm
- 20-359-75 T** 50 x 24 mm
- 20-359-76 T** 55 x 24 mm
- 20-359-77 T** 60 x 24 mm
- 20-359-78 T** 65 x 24 mm
- 20-359-79 T** 70 x 24 mm



max. Spreizweite 80 mm  
 max. spread 80 mm  
 apertura máxima 80 mm  
 apertura massima 80 mm

**CLOWARD**

**20-360-00** SET



Wundspreizer, komplett,  
 bestehend aus:

1 Sperrer	<b>20-360-01</b>
1 Seitenvalve 40 mm	<b>20-362-02</b>
1 Seitenvalve 45 mm	<b>20-362-03</b>
1 Seitenvalve 50 mm	<b>20-362-04</b>
1 Seitenvalve 55 mm	<b>20-362-05</b>
1 Seitenvalve 60 mm	<b>20-362-06</b>

Self-retaining retractor,  
 complete, consisting of:

1 Spreader	<b>20-360-01</b>
1 Lateral valve 40 mm	<b>20-362-02</b>
1 Lateral valve 45 mm	<b>20-362-03</b>
1 Lateral valve 50 mm	<b>20-362-04</b>
1 Lateral valve 55 mm	<b>20-362-05</b>
1 Lateral valve 60 mm	<b>20-362-06</b>

Separador, completo,  
 compuesto de:

1 Separador	<b>20-360-01</b>
1 Valva lateral 40 mm	<b>20-362-02</b>
1 Valva lateral 45 mm	<b>20-362-03</b>
1 Valva lateral 50 mm	<b>20-362-04</b>
1 Valva lateral 55 mm	<b>20-362-05</b>
1 Valva lateral 60 mm	<b>20-362-06</b>

Divaricatore, completo,  
 composto da:

1 Divaricatore	<b>20-360-01</b>
1 Valva laterale 40 mm	<b>20-362-02</b>
1 Valva laterale 45 mm	<b>20-362-03</b>
1 Valva laterale 50 mm	<b>20-362-04</b>
1 Valva laterale 55 mm	<b>20-362-05</b>
1 Valva laterale 60 mm	<b>20-362-06</b>



**20-362-02** 40 mm    **20-362-03** 45 mm    **20-362-04** 50 mm    **20-362-05** 55 mm    **20-362-06** 60 mm



Pinzette zum Valvenwechsel bei Kugel-  
 schnellverschluß-System

Forceps for changing valves with ball snap  
 closure system

Pinza para el cambio de valvas con el  
 sistema de cierre rápido esférico

Pinza per il cambio delle valve a chiusura  
 istantanea



**20-358-99** 11,5 cm, 4 1/2"



max. Spreizweite 60 mm  
 max. spread 60 mm  
 apertura máxima 60 mm  
 apertura massima 60 mm

## CLOWARD

**20-362-00** SET



Wundspreizer, komplett,  
 bestehend aus:

1 Sperrer	<b>20-362-01</b>
1 Seitenvlve 40 mm	<b>20-362-12</b>
1 Seitenvlve 45 mm	<b>20-362-13</b>
1 Seitenvlve 50 mm	<b>20-362-14</b>
1 Seitenvlve 55 mm	<b>20-362-15</b>
1 Seitenvlve 60 mm	<b>20-362-16</b>

Self-retaining retractor,  
 complete, consisting of:

1 Spreader	<b>20-362-01</b>
1 Lateral valve 40 mm	<b>20-362-12</b>
1 Lateral valve 45 mm	<b>20-362-13</b>
1 Lateral valve 50 mm	<b>20-362-14</b>
1 Lateral valve 55 mm	<b>20-362-15</b>
1 Lateral valve 60 mm	<b>20-362-16</b>

Separador, completo,  
 compuesto de:

1 Separador	<b>20-362-01</b>
1 Valva lateral 40 mm	<b>20-362-12</b>
1 Valva lateral 45 mm	<b>20-362-13</b>
1 Valva lateral 50 mm	<b>20-362-14</b>
1 Valva lateral 55 mm	<b>20-362-15</b>
1 Valva lateral 60 mm	<b>20-362-16</b>

Divaricatore, completo,  
 composto da:

1 Divaricatore	<b>20-362-01</b>
1 Valva laterale 40 mm	<b>20-362-12</b>
1 Valva laterale 45 mm	<b>20-362-13</b>
1 Valva laterale 50 mm	<b>20-362-14</b>
1 Valva laterale 55 mm	<b>20-362-15</b>
1 Valva laterale 60 mm	<b>20-362-16</b>



**20-362-12**

40 mm

**20-362-13**

45 mm

**20-362-14**

50 mm

**20-362-15**

55 mm

**20-362-16**

60 mm



Pinzette zum Valvenwechsel bei Kugel-  
 schnellverschluss-System

Forceps for changing valves with ball snap  
 closure system

Pinza para el cambio de valvas con el  
 sistema de cierre rápido esférico

Pinza per il cambio delle valve a chiusura  
 istantanea



**20-358-99** 11,5 cm, 4 1/2"





**CASPAR**

**20-365-00** SET



Wundspreizer, komplett,  
 bestehend aus:

1 Sperrer	<b>20-365-01</b>
1 Valve, gezahnt 40 mm	<b>20-365-40</b>
1 Valve, gezahnt 45 mm	<b>20-365-45</b>
1 Valve, gezahnt 50 mm	<b>20-365-50</b>
1 Valve, gezahnt 55 mm	<b>20-365-55</b>
1 Valve, gezahnt 60 mm	<b>20-365-60</b>
1 Valve, gezahnt 65 mm	<b>20-365-65</b>
1 Valve, gezahnt 70 mm	<b>20-365-70</b>

Self-retaining retractor,  
 complete, consisting of:

1 Spreader	<b>20-365-01</b>
1 Serrated valve 40 mm	<b>20-365-40</b>
1 Serrated valve 45 mm	<b>20-365-45</b>
1 Serrated valve 50 mm	<b>20-365-50</b>
1 Serrated valve 55 mm	<b>20-365-55</b>
1 Serrated valve 60 mm	<b>20-365-60</b>
1 Serrated valve 65 mm	<b>20-365-65</b>
1 Serrated valve 70 mm	<b>20-365-70</b>

Separador, completo,  
 compuesto de:

1 Separador	<b>20-365-01</b>
1 Valva dentada 40 mm	<b>20-365-40</b>
1 Valva dentada 45 mm	<b>20-365-45</b>
1 Valva dentada 50 mm	<b>20-365-50</b>
1 Valva dentada 55 mm	<b>20-365-55</b>
1 Valva dentada 60 mm	<b>20-365-60</b>
1 Valva dentada 65 mm	<b>20-365-65</b>
1 Valva dentada 70 mm	<b>20-365-70</b>

Divaricatore, completo,  
 composto da:

1 Divaricatore	<b>20-365-01</b>
1 Valva dentellata 40 mm	<b>20-365-40</b>
1 Valva dentellata 45 mm	<b>20-365-45</b>
1 Valva dentellata 50 mm	<b>20-365-50</b>
1 Valva dentellata 55 mm	<b>20-365-55</b>
1 Valva dentellata 60 mm	<b>20-365-60</b>
1 Valva dentellata 65 mm	<b>20-365-65</b>
1 Valva dentellata 70 mm	<b>20-365-70</b>







## MLD

**20-366-00** SET



Lumbales Mikrodiskektomie Retraktor Set, bestehend aus:

Micro lumbar discectomy retractor Set, consisting of:

2 Draht-Siebschalen	<b>55-191-07</b>	2 Wire baskets	<b>55-191-07</b>
2 Silikon Nopenmatten	<b>55-855-00</b>	2 Silicone mats	<b>55-855-00</b>
2 OPTücher	<b>55-890-09</b>	2 OT towels	<b>55-890-09</b>
2 Kennzeichnungsschilder	<b>55-820-04</b>	2 Identification labels	<b>55-820-04</b>
6 Caspar Spekulas, 40 - 65 mm	<b>20-366-40 - 20-366-65</b>	6 Caspar speculas, 40 - 65 mm	<b>20-366-40 - 20-366-65</b>
1 Caspar Gegensperrer	<b>20-367-01</b>	1 Caspar counter retractor	<b>20-367-01</b>
7 Laterale Valven, 35 - 65 mm	<b>20-367-02 - 20-367-08</b>	7 Lateral valves, 35 - 65 mm	<b>20-367-02 - 20-367-08</b>
1 Blätterwechselepinzette	<b>20-358-99</b>	1 Valve changing forceps	<b>20-358-99</b>

Microdissectomía lumbar separador Set, compuesto de:

Lombare microdischectomia divaricatori Set, composto da:

2 Cesta de alambre	<b>55-191-07</b>	2 Castello in rete metallica	<b>55-191-07</b>
2 Soportes de silicona	<b>55-855-00</b>	2 Suppórtui in silicone	<b>55-855-00</b>
2 Paño	<b>55-890-09</b>	2 Tessuto	<b>55-890-09</b>
2 Placa de identificación	<b>55-820-04</b>	2 Targhette di identification	<b>55-820-04</b>
6 Caspar espéculos, 40 - 65 mm	<b>20-366-40 - 20-366-65</b>	6 Caspar speculi, 40 - 65 mm	<b>20-366-40 - 20-366-65</b>
1 Caspar contraseparador	<b>20-367-01</b>	1 Caspar divaricatori	<b>20-367-01</b>
7 Valvas lateral, 35 - 65 mm	<b>20-367-02 - 20-367-08</b>	7 Valva laterale, 35 - 65 mm	<b>20-367-02 - 20-367-08</b>
1 Pinza para valvas	<b>20-358-99</b>	1 Pinza per valve	<b>20-358-99</b>



max. Spreizweite 60 mm  
max. spread 60 mm  
apertura máxima 60 mm  
apertura massima 60 mm

**CASPAR**

**20-367-00** SET



Wundspreizer mit Gelenkarmen und Kugelschnellverschluß komplett, bestehend aus:

Self-retaining retractor with hinged arms and ball snap closure, complete, consisting of:

1 Rahmen	<b>20-367-01</b>	1 Frame	<b>20-367-01</b>
1 Seitenvalve, 35 mm	<b>20-367-02</b>	1 Lateral valve, 35 mm	<b>20-367-02</b>
1 Seitenvalve, 40 mm	<b>20-367-03</b>	1 Lateral valve, 40 mm	<b>20-367-03</b>
1 Seitenvalve, 45 mm	<b>20-367-04</b>	1 Lateral valve, 45 mm	<b>20-367-04</b>
1 Seitenvalve, 50 mm	<b>20-367-05</b>	1 Lateral valve, 50 mm	<b>20-367-05</b>
1 Seitenvalve, 55 mm	<b>20-367-06</b>	1 Lateral valve, 55 mm	<b>20-367-06</b>
1 Seitenvalve, 60 mm	<b>20-367-07</b>	1 Lateral valve, 60 mm	<b>20-367-07</b>

Seperador con brazos articulados y cierre rápido esférico, completo compuesto de:

Divaricatore con braccio articolato a chiusura istantanea, completo, composto da:

1 Separador	<b>20-367-01</b>	1 Divaricatore	<b>20-367-01</b>
1 Valva lateral, 35 mm	<b>20-367-02</b>	1 Valva laterale, 35 mm	<b>20-367-02</b>
1 Valva lateral, 40 mm	<b>20-367-03</b>	1 Valva laterale, 40 mm	<b>20-367-03</b>
1 Valva lateral, 45 mm	<b>20-367-04</b>	1 Valva laterale, 45 mm	<b>20-367-04</b>
1 Valva lateral, 50 mm	<b>20-367-05</b>	1 Valva laterale, 50 mm	<b>20-367-05</b>
1 Valva lateral, 55 mm	<b>20-367-06</b>	1 Valva laterale, 55 mm	<b>20-367-06</b>
1 Valva lateral, 60 mm	<b>20-367-07</b>	1 Valva laterale, 60 mm	<b>20-367-07</b>



**20-367-02**

**20-367-03**

**20-367-04**

**20-367-05**

**20-367-06**

**20-367-07**

35 mm

40 mm

45 mm

50 mm

55 mm

60 mm





Laterale Valven mit Kugelschnellverschluss  
 Lateral valves with ball snap closure  
 Valvas laterales con cierre rápido esférico  
 Valve laterali a chiusura istantanea



Mediale Valven mit Kugelschnellverschluss  
 Medial valves with ball snap closure  
 Valvas mediales con cierre rápido esférico  
 Valve medie a chiusura istantanea



Pinzette zum Valvenwechsel bei Kugel-  
 schnellverschluss-System  
 Forceps for changing valves with ball snap  
 closure system  
 Pinza para el cambio de valvas con el  
 sistema de cierre rápido esférico  
 Pinza per il cambio delle valve a chiusura  
 istantanea



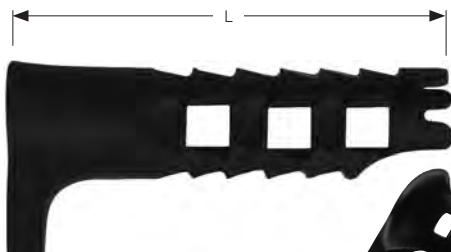
**20-358-99** 11,5 cm, 4 1/2"

### CASPAR

<b>20-367-02</b>	35 mm
<b>20-367-03</b>	40 mm
<b>20-367-04</b>	45 mm
<b>20-367-05</b>	50 mm
<b>20-367-06</b>	55 mm
<b>20-367-07</b>	60 mm
<b>20-367-08</b>	65 mm
<b>20-367-09</b>	75 mm
<b>20-367-10</b>	85 mm

### CASPAR

<b>20-367-13</b>	40 mm
<b>20-367-14</b>	45 mm
<b>20-367-15</b>	50 mm
<b>20-367-16</b>	55 mm
<b>20-367-17</b>	60 mm
<b>20-367-18</b>	65 mm
<b>20-367-19</b>	70 mm

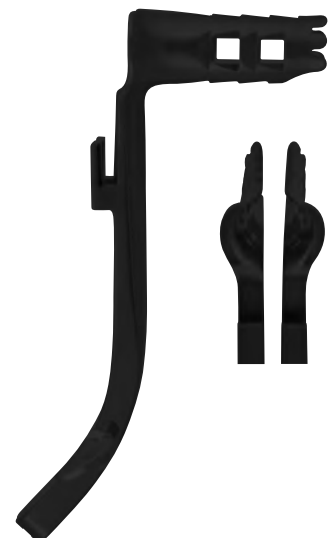


### CASPAR

<b>20-366-40</b>	40 mm
<b>20-366-45</b>	45 mm
<b>20-366-50</b>	50 mm
<b>20-366-55</b>	55 mm
<b>20-366-60</b>	60 mm
<b>20-366-65</b>	65 mm
<b>20-366-70</b>	70 mm
<b>20-366-75</b>	75 mm
<b>20-366-85</b>	85 mm

### STOTZ

<b>20-366-01</b>	40 mm
<b>20-366-02</b>	45 mm
<b>20-366-03</b>	50 mm
<b>20-366-04</b>	55 mm
<b>20-366-05</b>	60 mm
<b>20-366-06</b>	65 mm
<b>20-366-07</b>	70 mm
<b>20-366-08</b>	75 mm
<b>20-366-09</b>	85 mm





max. Spreizweite 70 | 90 mm  
max. spread 70 | 90 mm  
apertura máxima 70 | 90 mm  
apertura massima 70 | 90 mm

### MC CULLOCH

**20-368-00** 70 mm  
**20-368-02** 90 mm



max. Spreizweite 67 mm  
max. spread 67 mm  
apertura máxima 67 mm  
apertura massima 67 mm

### MC CULLOCH

**20-368-01** 67 mm



Muskelblätter, 4 Zinken, schmal  
Muscle blades, 4 prongs, narrow  
Valvas musculares, 4 dientes, estrechas  
Valve muscolari, 4 punte, sottili

Muskelblätter, 6 Zinken, breit  
Muscle blades, 6 prongs, wide  
Valvas musculares, 6 dientes, anchas  
Valve muscolari, 6 punte, larghe



### MC CULLOCH

**20-368-03** 30 x 20 mm  
**20-368-04** 40 x 20 mm  
**20-368-05** 50 x 20 mm  
**20-368-06** 60 x 20 mm  
**20-368-07** 70 x 20 mm  
**20-368-08** 80 x 20 mm  
**20-368-09** 90 x 20 mm  
**20-368-10** 100 x 20 mm  
**20-368-11** 120 x 20 mm



### MC CULLOCH

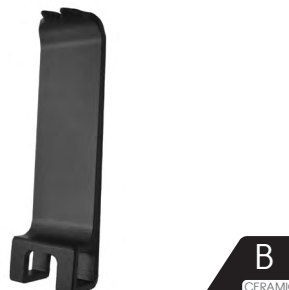
**20-368-13** 30 x 27 mm  
**20-368-14** 40 x 27 mm  
**20-368-15** 50 x 27 mm  
**20-368-16** 60 x 27 mm  
**20-368-17** 70 x 27 mm  
**20-368-18** 80 x 27 mm  
**20-368-19** 90 x 27 mm  
**20-368-20** 100 x 27 mm



Muskelblätter, 2 Zinken, schmal  
 Muscle blades, 2 prongs, narrow  
 Valvas musculares, 2 dientes, estrechas  
 Valve muscolari, 2 punte, sottili



Cervikal Blätter, 2 Zinken  
 Cervical blades, 2 prongs  
 Valvas cervicales, 2 dientes  
 Valve cervicali, 2 punte



## MC CULLOCH

<b>20-368-23</b>	30 x 27 mm
<b>20-368-24</b>	40 x 27 mm
<b>20-368-25</b>	50 x 27 mm
<b>20-368-26</b>	60 x 27 mm
<b>20-368-27</b>	70 x 27 mm
<b>20-368-28</b>	80 x 27 mm
<b>20-368-29</b>	90 x 27 mm

## MC CULLOCH

<b>20-368-35</b>	50 x 20 mm
<b>20-368-36</b>	60 x 20 mm
<b>20-368-37</b>	70 x 20 mm

Hakenblätter  
 Hook blades  
 Valvas con gancho  
 Divaricatori a valve



Hakenblätter, mehrfach gezahnt  
 Hook blades, multiple serrated  
 Valvas con gancho, dentado múltiple  
 Divaricatori a valve, dentato su diversi lati

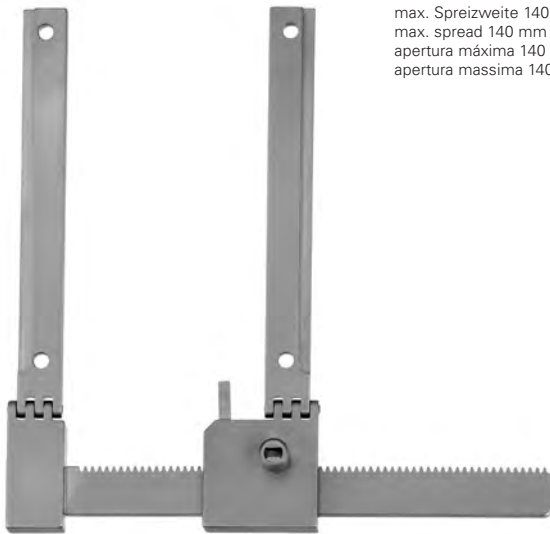


## MC CULLOCH

<b>20-369-02</b>	20 mm
<b>20-369-03</b>	30 mm
<b>20-369-04</b>	40 mm
<b>20-369-05</b>	50 mm
<b>20-369-06</b>	60 mm
<b>20-369-07</b>	70 mm
<b>20-369-08</b>	80 mm
<b>20-369-09</b>	90 mm

## MC CULLOCH

<b>20-369-12</b>	20 mm
<b>20-369-13</b>	30 mm
<b>20-369-14</b>	40 mm
<b>20-369-15</b>	50 mm
<b>20-369-16</b>	60 mm
<b>20-369-17</b>	70 mm
<b>20-369-18</b>	80 mm
<b>20-369-19</b>	90 mm



max. Spreizweite 140 mm  
max. spread 140 mm  
apertura máxima 140 mm  
apertura massima 140 mm

## KARLIN-CRANK

**20-370-00** SET

Wundspreizer mit Gelenkarmen,  
komplett, bestehend aus:

Self-retaining retractor with hinged  
arms, complete, consisting of:

1 Rahmen	<b>20-370-01</b>	1 Frame	<b>20-370-01</b>
1 Schlüssel	<b>20-370-05</b>	1 Key	<b>20-370-05</b>
1 Blatt, links, 31x38 mm	<b>20-370-10</b>	1 Blade, left, 31x38 mm	<b>20-370-10</b>
1 Blatt, rechts, 31x38 mm	<b>20-370-11</b>	1 Blade, right, 31x38 mm	<b>20-370-11</b>
1 Blatt, links, 57x44 mm	<b>20-370-12</b>	1 Blade, left, 57x44 mm	<b>20-370-12</b>
1 Blatt, rechts, 57x44 mm	<b>20-370-13</b>	1 Blade, right, 57x44 mm	<b>20-370-13</b>
2 Blätter, 76x64 mm	<b>20-370-14</b>	2 Blades, 76x64 mm	<b>20-370-14</b>

Seperador con brazos articulados,  
completo, compuesto de:

Divaricatore con braccio articolato,  
completo, composto da:

1 Cuadro	<b>20-370-01</b>	1 Telaio	<b>20-370-01</b>
1 Llave	<b>20-370-05</b>	1 Chiave	<b>20-370-05</b>
1 Valva, zurdo, 31x38mm	<b>20-370-10</b>	1 Valva, sinistra, 37x22 mm	<b>20-370-10</b>
1 Valva, derecha, 31x38mm	<b>20-370-11</b>	1 Valva, destra, 37x22 mm	<b>20-370-11</b>
1 Valva, zurdo, 57x44mm	<b>20-370-12</b>	1 Valva, sinistra, 57x44 mm	<b>20-370-12</b>
1 Valva, derecha, 57x44mm	<b>20-370-13</b>	1 Valva, destra, 57x44 mm	<b>20-370-13</b>
1 Valva, 76x64mm	<b>20-370-14</b>	1 Valva, 76x64 mm	<b>20-370-14</b>



**20-370-10**

31 x 38 mm



**20-370-11**

31 x 38 mm



**20-370-12**

57 x 44 mm



**20-370-13**

57 x 44 mm



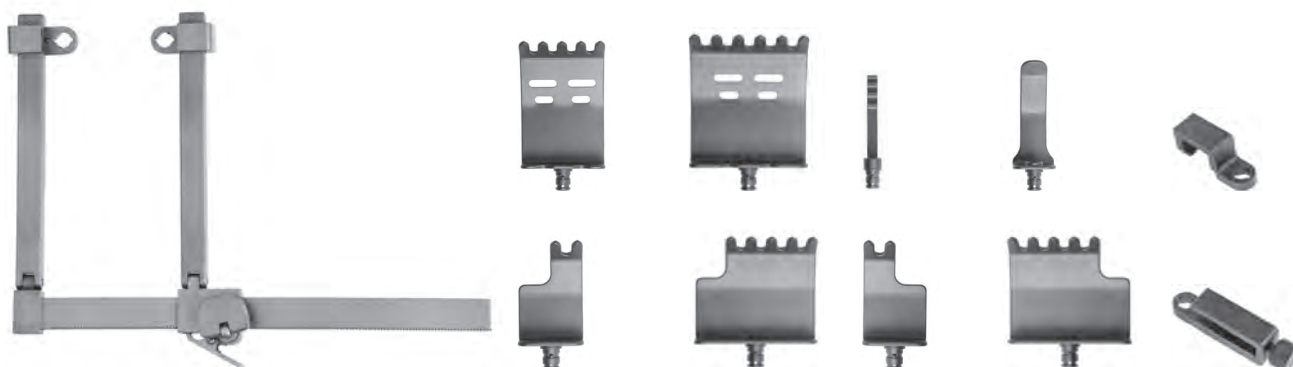
**20-370-14**

76 x 64 mm



Schlüssel  
Key  
llave  
Chiave

**20-370-05**



## SPREADY

### 20-370-30 T SET



Wundspreizer mit Gelenkarmen,  
komplett, bestehend aus:

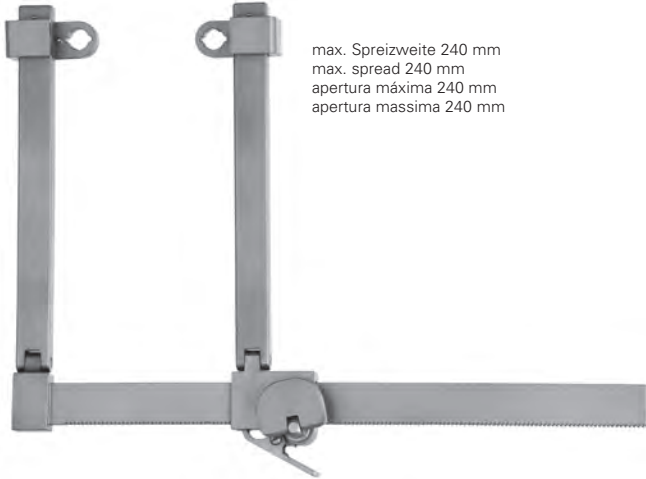
Self-retaining retractor with hinged  
arms, complete, consisting of:

1 Rahmen	<b>20-370-32 T</b>	1 Frame	<b>20-370-32 T</b>
2 L. Blatt, 46 x 45 mm	<b>20-370-52 T</b>	2 L. blade, 46 x 45 mm	<b>20-370-52 T</b>
2 L. Blatt, 56 x 45 mm	<b>20-370-53 T</b>	2 L. blade, 56 x 45 mm	<b>20-370-53 T</b>
2 L. Blatt, 66 x 45 mm	<b>20-370-54 T</b>	2 L. blade, 66 x 45 mm	<b>20-370-54 T</b>
2 L. Blatt, 76 x 45 mm	<b>20-370-55 T</b>	2 L. blade, 76 x 45 mm	<b>20-370-55 T</b>
2 L. Blatt, 46 x 60 mm	<b>20-370-62 T</b>	2 L. blade, 46 x 60 mm	<b>20-370-62 T</b>
2 L. Blatt, 56 x 60 mm	<b>20-370-63 T</b>	2 L. blade, 56 x 60 mm	<b>20-370-63 T</b>
2 L. Blatt, 66 x 60 mm	<b>20-370-64 T</b>	2 L. blade, 66 x 60 mm	<b>20-370-64 T</b>
2 L. Blatt, 76 x 60 mm	<b>20-370-65 T</b>	2 L. blade, 76 x 60 mm	<b>20-370-65 T</b>
2 L. Haken Blatt, 42 mm	<b>20-370-72 T</b>	2 L. hook blade, 42 mm	<b>20-370-72 T</b>
2 L. Haken Blatt, 52 mm	<b>20-370-73 T</b>	2 L. hook blade, 52 mm	<b>20-370-73 T</b>
2 L. Haken Blatt, 62 mm	<b>20-370-74 T</b>	2 L. hook blade, 62 mm	<b>20-370-74 T</b>
2 L. Haken Blatt, 72 mm	<b>20-370-75 T</b>	2 L. hook blade, 72 mm	<b>20-370-75 T</b>
1 Blatt V1, 36 x 30 mm	<b>20-370-91 T</b>	1 Blade V1, 36 x 30 mm	<b>20-370-91 T</b>
1 Blatt V2, 36 x 30 mm	<b>20-370-93 T</b>	1 Blade V2, 36 x 30 mm	<b>20-370-93 T</b>
1 Blatt V1, 41 x 60 mm	<b>20-370-92 T</b>	1 Blade V1, 41 x 60 mm	<b>20-370-92 T</b>
1 Blatt V2, 41 x 60 mm	<b>20-370-94 T</b>	1 Blade V2, 41 x 60 mm	<b>20-370-94 T</b>
2 Aufnahmen, justierbar	<b>20-370-35 T</b>	2 Adapters, adjustable	<b>20-370-35 T</b>
1 Aufnahme, Verschluß	<b>20-370-36 T</b>	1 Adapter, w. closure	<b>20-370-36 T</b>

Seperador con brazos articulados,  
completo, compuesto de:

Divaricatore con braccio articolato,  
completo, composto da:

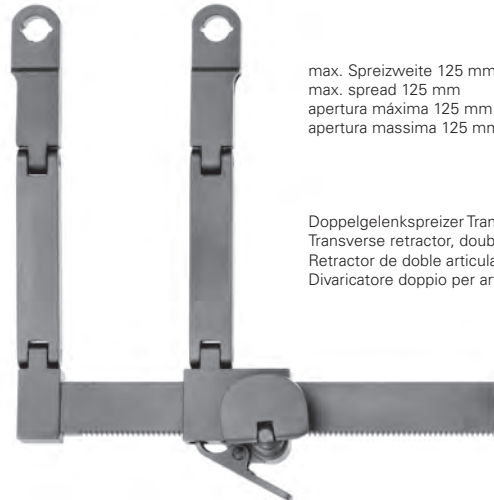
1 Cuadro	<b>20-370-32 T</b>	1 Telaio	<b>20-370-32 T</b>
2 L. valva, 46 x 45 mm	<b>20-370-52 T</b>	2 L. valva, 46 x 45 mm	<b>20-370-52 T</b>
2 L. valva, 56 x 45 mm	<b>20-370-53 T</b>	2 L. valva, 56 x 45 mm	<b>20-370-53 T</b>
2 L. valva, 66 x 45 mm	<b>20-370-54 T</b>	2 L. valva, 66 x 45 mm	<b>20-370-54 T</b>
2 L. valva, 76 x 45 mm	<b>20-370-55 T</b>	2 L. valva, 76 x 45 mm	<b>20-370-55 T</b>
2 L. valva, 46 x 60 mm	<b>20-370-62 T</b>	2 L. valva, 46 x 60 mm	<b>20-370-62 T</b>
2 L. valva, 56 x 60 mm	<b>20-370-63 T</b>	2 L. valva, 56 x 60 mm	<b>20-370-63 T</b>
2 L. valva, 66 x 60 mm	<b>20-370-64 T</b>	2 L. valva, 66 x 60 mm	<b>20-370-64 T</b>
2 L. valva, 76 x 60 mm	<b>20-370-65 T</b>	2 L. valva, 76 x 60 mm	<b>20-370-65 T</b>
2 L. valva gancho 42 mm	<b>20-370-72 T</b>	2 L. Divari. valva, 42 mm	<b>20-370-72 T</b>
2 L. valva gancho 52 mm	<b>20-370-73 T</b>	2 L. Divari. valva, 52 mm	<b>20-370-73 T</b>
2 L. valva gancho 62 mm	<b>20-370-74 T</b>	2 L. Divari. valva, 62 mm	<b>20-370-74 T</b>
2 L. valva gancho 72 mm	<b>20-370-75 T</b>	2 L. Divari. valva, 72 mm	<b>20-370-75 T</b>
1 Valva V1, 36 x 30 mm	<b>20-370-91 T</b>	1 Valva V1, 36 x 30 mm	<b>20-370-91 T</b>
1 Valva V2, 36 x 30 mm	<b>20-370-93 T</b>	1 Valva V2, 36 x 30 mm	<b>20-370-93 T</b>
1 Valva V1, 41 x 60 mm	<b>20-370-92 T</b>	1 Valva V1, 41 x 60 mm	<b>20-370-92 T</b>
1 Valva V2, 41 x 60 mm	<b>20-370-94 T</b>	1 Valva V2, 41 x 60 mm	<b>20-370-94 T</b>
2 Soporte de valvas	<b>20-370-35 T</b>	2 Supporto valva	<b>20-370-35 T</b>
1 Soporte de valvas	<b>20-370-36 T</b>	1 Supporto valva	<b>20-370-36 T</b>



max. Spreizweite 240 mm  
max. spread 240 mm  
apertura máxima 240 mm  
apertura massima 240 mm

**SPREADY**

**20-370-32 T**



max. Spreizweite 125 mm  
max. spread 125 mm  
apertura máxima 125 mm  
apertura massima 125 mm

Doppelgelenkspreizer Transversal  
Transverse retractor, double hinged  
Retractor de doble articulación, transversal  
Divaricatore doppio per articolazione trasversale

**SPREADY**

**20-370-33 T**



Lumbar Blätter, 3 Zinken mit Kugelschnellverschluss  
Lumbar blades, 3 prongs with ball snap closure  
Valvas lumbares, 3 dientes con cierre rápido esférico  
Valve lombari, 3 punte a chiusura istantanea



Lumbar Blätter, 5 Zinken mit Kugelschnellverschluss  
Lumbar blades, 5 prongs with ball snap closure  
Valvas lumbares, 5 dientes con cierre rápido esférico  
Valve lombari, 5 punte a chiusura istantanea



Lumbar Blätter, 6 Zinken mit Kugelschnellverschluss  
Lumbar blades, 6 prongs with ball snap closure  
Valvas lumbares, 6 dientes con cierre rápido esférico  
Valve lombari, 6 punte a chiusura istantanea



**SPREADY**

- 20-370-40 T** 30 x 20 mm
- 20-370-41 T** 35 x 20 mm
- 20-370-42 T** 40 x 20 mm
- 20-370-43 T** 50 x 20 mm
- 20-370-44 T** 60 x 20 mm
- 20-370-45 T** 70 x 20 mm
- 20-370-46 T** 80 x 20 mm
- 20-370-47 T** 90 x 20 mm
- 20-370-48 T** 100 x 20 mm
- 20-370-49 T** 110 x 20 mm



**SPREADY**

- 20-370-52 T** 46 x 45 mm
- 20-370-53 T** 56 x 45 mm
- 20-370-54 T** 66 x 45 mm
- 20-370-55 T** 76 x 45 mm



**SPREADY**

- 20-370-62 T** 46 x 60 mm
- 20-370-63 T** 56 x 60 mm
- 20-370-64 T** 66 x 60 mm
- 20-370-65 T** 76 x 60 mm





Lumbale Hakenblätter mit Kugelschnellverschluss  
 Lumbar hook blades with ball snap closure  
 Valvas con gancho lumbares con cierre rápido esférico  
 Divaricatori lombari a valve a chiusura istantanea



### SPREADY

**20-370-72 T** 42 x 6 mm

**20-370-73 T** 52 x 6 mm

**20-370-74 T** 62 x 6 mm

**20-370-75 T** 72 x 6 mm



Stumpfe Blätter mit Kugelschnellverschluss  
 Blunt blades with ball snap closure  
 Valvas romas con cierre rápido esférico  
 Valve smusse a chiusura istantanea



### SPREADY

**20-370-81 T** 30 x 15 mm

**20-370-82 T** 40 x 15 mm

**20-370-83 T** 50 x 15 mm

**20-370-84 T** 60 x 15 mm

**20-370-85 T** 70 x 15 mm

Blattaufnahme mit Verschluss  
 Blade adapter with closure  
 Soporte de valvas con cierre  
 Supporto valva con chiusura



### SPREADY

**20-370-36 T**

Blattaufnahme mit Rändelschraube, justierbar  
 Blade adapter with knurled screw, adjustable  
 Soporte de valvas con tornillo moleteado, ajustable  
 Supporto valva con vite a testa zigrinata, regolabile



### SPREADY

**20-370-35 T**



Sakral Lumbale Blätter mit Kugelschnellverschluss  
 Sacral lumbar blades with ball snap closure  
 Valvas lumbares sacras con cierre rápido esférico  
 Divaricatori sacrali a valve a chiusura istantanea



### SPREADY

**20-370-91 T** 36 x 30 mm



### SPREADY

**20-370-93 T** 36 x 30 mm



### SPREADY

**20-370-94 T** 41 x 60 mm



### SPREADY

**20-370-92 T** 41 x 60 mm

max. Spreizweite 20 mm  
 max. spread 20 mm  
 apertura máxima 20 mm  
 apertura massima 20 mm



**CLOWARD**

**20-371-13** 13,5 cm, 5 1/4"

max. Spreizweite 15 mm  
 max. spread 15 mm  
 apertura máxima 15 mm  
 apertura massima 15 mm



**CLOWARD**

**20-371-15** 15,5 cm, 6 1/8"

max. Spreizweite 38 mm  
 max. spread 38 mm  
 apertura máxima 38 mm  
 apertura massima 38 mm



**INGE**

**20-375-01** 17,0 cm, 6 3/4"

max. Spreizweite 38 mm  
 max. spread 38 mm  
 apertura máxima 38 mm  
 apertura massima 38 mm



**INGE**

**20-375-02** 17,0 cm, 6 3/4"

max. Spreizweite 50 mm  
 max. spread 50 mm  
 apertura máxima 50 mm  
 apertura massima 50 mm



**INGE**

**20-376-27** 27,5 cm, 10 3/4"

max. Spreizweite 50 mm  
 max. spread 50 mm  
 apertura máxima 50 mm  
 apertura massima 50 mm



Konkav  
 Concave  
 Côncavo  
 Concavo

**INGE**

**20-377-27** 27,5 cm, 10 3/4"



max. Spreizweite 80 mm  
max. spread 80 mm  
apertura máxima 80 mm  
apertura massima 80 mm



### CLOWARD

**20-380-12** 13,0 cm, 5 ¼"

max. Spreizweite 70 mm  
max. spread 70 mm  
apertura máxima 70 mm  
apertura massima 70 mm



### CLOWARD

**20-380-13** 13,5 cm, 5 ¼"

max. Spreizweite 70 mm  
max. spread 70 mm  
apertura máxima 70 mm  
apertura massima 70 mm



### CLOWARD

**20-380-16** 16,5 cm, 6 ¼"

max. Spreizweite 105 mm  
max. spread 105 mm  
apertura máxima 105 mm  
apertura massima 105 mm



### KNIGHTON

**20-381-19** 19,0 cm, 7 ½"

max. Spreizweite 105 mm  
max. spread 105 mm  
apertura máxima 105 mm  
apertura massima 105 mm



### KNIGHTON

**20-382-19** 19,0 cm, 7 ½"



<b>20-450-40</b>	40 x 10 mm
<b>20-450-50</b>	50 x 10 mm
<b>20-450-60</b>	60 x 10 mm
<b>20-450-70</b>	70 x 10 mm
<b>20-451-50</b>	50 x 20 mm
<b>20-451-60</b>	60 x 20 mm
<b>20-451-70</b>	70 x 20 mm

links  
 left  
 zurdo  
 sinistra

**SCHUL**

**20-450-40 - 20-451-70** 17,0 cm, 6 3/4"



<b>20-452-40</b>	40 x 10 mm
<b>20-452-50</b>	50 x 10 mm
<b>20-452-60</b>	60 x 10 mm
<b>20-452-70</b>	70 x 10 mm
<b>20-453-50</b>	50 x 20 mm
<b>20-453-60</b>	60 x 20 mm
<b>20-453-70</b>	70 x 20 mm

rechts  
 right  
 derecha  
 destra

**SCHUL**

**20-452-40 - 20-453-70** 17,0 cm, 6 3/4"

# 26

HNO-Instrumente

ENT Instruments

Instrumentos para ORL

Strumenti per ORL





# 26

Mikro Instrumente

Micro Instruments

Instrumentos de micro

Strumentario micro







26

Endoskope  
Endoscopes  
Endoscopios  
Endoscopi





**26-000-14** 14,5 cm, 5 3/4"



**26-002-14** 14,0 cm, 5 1/2"



**MAYO**  
**26-004-16** 17,0 cm, 6 3/4"



**BUCHWALD**  
**26-004-18** 18,0 cm, 7"



**BRUENINGS**  
**26-006-19** 19,0 cm, 7 1/2"



**FRENZEL**  
**26-007-16** 16,5 cm, 6 1/2"

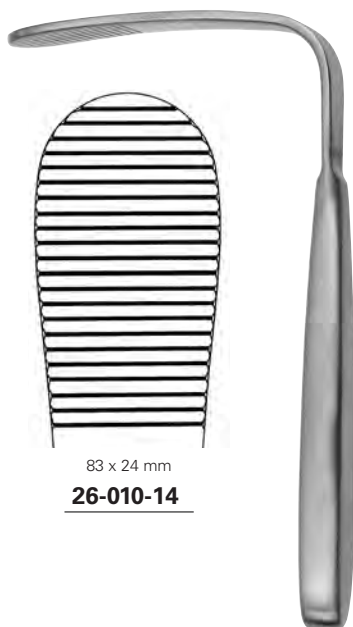


**FRENZEL**  
**26-008-14** 14,5 cm, 5 3/4"



### LACK

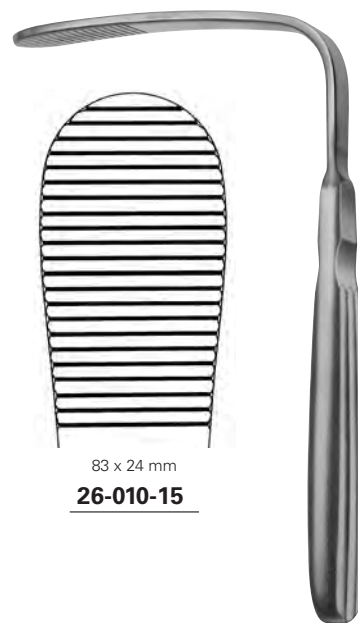
<b>26-009-13</b>	13,0 mm
<b>26-009-19</b>	19,0 mm
<b>26-009-22</b>	22,0 mm



83 x 24 mm  
**26-010-14**

### TOBOLD

**26-010-14** 14,0 cm, 5 ½"



83 x 24 mm  
**26-010-15**

### TOBOLD

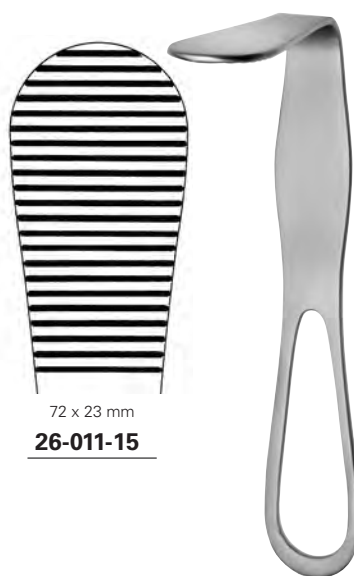
**26-010-15** 14,0 cm, 5 ½"

21 mm



### MORITZ-SCHMIDT

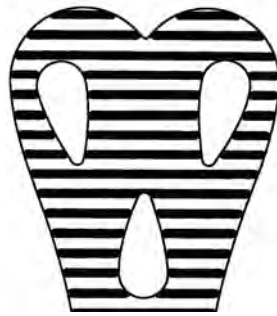
**26-010-19** 19,0 cm, 7 ½"



72 x 23 mm  
**26-011-15**

### HARTMANN

**26-011-15** 15,0 cm, 6"



30 x 90 mm

**26-017-01**

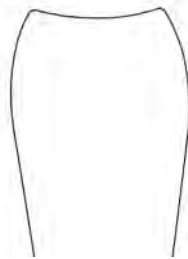


35 x 90 mm

**26-017-02**

**WIEDER**

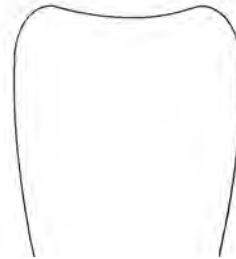
**26-017-01 - 26-017-02** 14,5 cm, 5 ¾"



22 mm

**26-018-13**

29 mm



30 mm

**26-018-16**

33 mm

**DOYEN**

**26-018-13** 13,0 cm, 5 ⅛"

**26-018-16** 16,0 cm, 6 ¼"



### HEISTER

**26-022-13** 13,0 cm, 5 "



### MOLT

**26-023-10** 10,0 cm, 4 "



### DOYEN-COLLIN

**26-025-12** 12,0 cm, 4 ¾ "

### 26-028-99

Ersatzbacken  
Spare jaws  
Bocas de repuesto  
Branche di ricambio



### DOYEN-JANSEN

**26-026-14** 14,0 cm, 5 ½ "



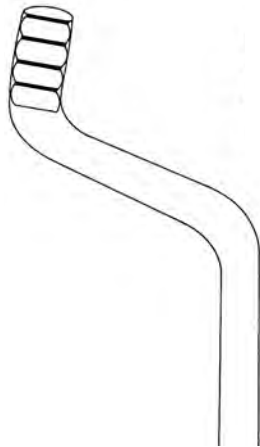
### FERGUSSON-ACKLAND

**26-027-14** 14,5 cm, 5 ¾ "

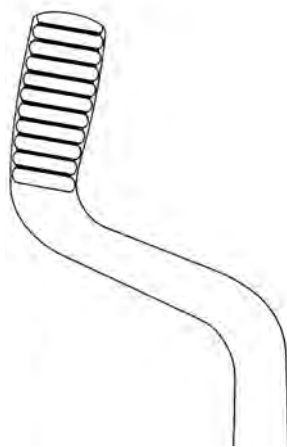


### DENHARDT

**26-028-12** 12,5 cm, 5 "



**26-029-16**



**26-029-19**

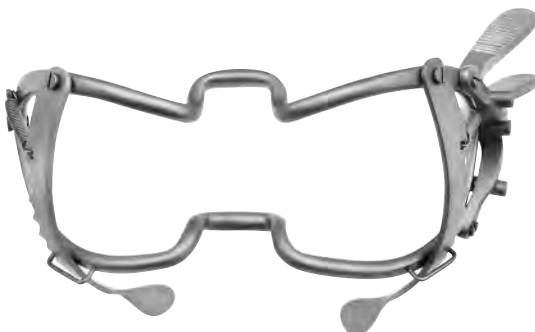
**ROSER-KOENIG**

**26-029-16** 16,0 cm, 6 ¼"

**26-029-19** 19,0 cm, 7 ½"

ohne Zungendrucker  
without tongue depressor  
sin depressor lingual  
senza abbassalingua

mit Zungendrucker  
with tongue depressor  
con depressor lingual  
con abbassalingua



**WHITEHEAD**

**26-031-09** 9,0 cm, 3 ½"

**26-031-11** 11,0 cm, 4 ¾"

**26-031-13** 13,0 cm, 5 ¼"

**26-031-15** 15,0 cm, 5 7/8"

**WHITEHEAD**

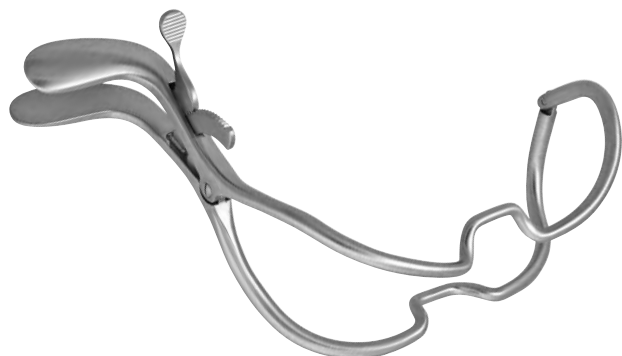
**26-032-11** 11,0 cm, 4 ¾"

**26-032-13** 13,0 cm, 5 ¼"

**26-032-15** 15,0 cm, 5 7/8"



ohne Zungendrücke  
without tongue depressor  
sin depressor lingual  
senza abbassalingua



### AMNOTEC-JENNINGS

<b>26-033-01</b>	9,0 cm, 3 1/2 "
<b>26-033-02</b>	11,0 cm, 4 3/8 "
<b>26-033-03</b>	13,0 cm, 5 1/8 "
<b>26-033-04</b>	15,0 cm, 5 7/8 "

ohne Zungendrücke  
without tongue depressor  
sin depressor lingual  
senza abbassalingua



### JENNINGS

<b>26-033-09</b>	9,0 cm, 3 1/2 "
<b>26-033-11</b>	11,0 cm, 4 3/8 "
<b>26-033-13</b>	13,0 cm, 5 1/8 "
<b>26-033-15</b>	15,0 cm, 5 7/8 "

ohne Zungendrücke  
without tongue depressor  
sin depressor lingual  
senza abbassalingua



### SEEMANN-SEIFFERT

<b>26-034-09</b>	9,0 cm, 3 1/2 "
<b>26-034-11</b>	11,0 cm, 4 3/8 "
<b>26-034-13</b>	13,0 cm, 5 1/8 "
<b>26-034-15</b>	15,0 cm, 5 7/8 "



Rahmen, mit 2 beweglichen Seitenventilen  
Frame, with 2 adjustable lateral valves  
Bastidor, con 2 valvas laterales movibles  
Telaio, con 2 valve laterali mobili

**DINGMANN**

**26-035-00** SET

Komplett, bestehend aus:

Complete, consisting of:

1 Rahmen	<b>26-035-04</b>	1 Frame	<b>26-035-04</b>
1 Zungendrücker, Fig. 1	<b>26-035-01</b>	1 Tounge depressor, Fig. 1	<b>26-035-01</b>
1 Zungendrücker, Fig. 2	<b>26-035-02</b>	1 Tounge depressor, Fig. 2	<b>26-035-02</b>
1 Zungendrücker, Fig. 3	<b>26-035-03</b>	1 Tounge depressor, Fig. 3	<b>26-035-03</b>

Completo, compuesto de:

Completo, composto da:

1 Bastidor	<b>26-035-04</b>	1 Telaio	<b>26-035-04</b>
1 Bajalengua, Fig. 1	<b>26-035-01</b>	1 Abassalingua, Fig. 1	<b>26-035-01</b>
1 Bajalengua, Fig. 2	<b>26-035-02</b>	1 Abassalingua, Fig. 2	<b>26-035-02</b>
1 Bajalengua, Fig. 3	<b>26-035-03</b>	1 Abassalingua, Fig. 3	<b>26-035-03</b>



**26-035-01**

65 x 25 mm



**26-035-02**

70 x 29 mm



**26-035-03**

80 x 32 mm





**DAVIS-MEYER**

**26-040-00**



**DAVIS-MEYER**

**26-040-03**

Gaumenplatte  
 palate plate  
 plaquita paladial  
 placca per palato



**DAVIS-MEYER**

**26-040-02**

Ersatz Silikoneinlagen  
 Spare silicone inserts  
 Plantilla de silicona  
 Piastre di ricambio



**DAVIS-MEYER**

**26-040-01**



**DAVIS-MEYER**

<b>26-053-01</b>	70 x 29 mm
<b>26-053-02</b>	75 x 30 mm
<b>26-053-03</b>	80 x 31 mm
<b>26-053-04</b>	85 x 32 mm
<b>26-053-05</b>	95 x 33 mm
<b>26-053-06</b>	100 x 33 mm
<b>26-053-07</b>	105 x 34 mm



**DAVIS-BOYLE**

**26-040-90** SET

Komplett, bestehend aus:

Complete, consisting of:

1 Rahmen	<b>26-041-00</b>	1 Frame	<b>26-041-00</b>
1 Zungendrücker, Fig. 1	<b>26-055-01</b>	1 Tounge depressor, Fig. 1	<b>26-055-01</b>
1 Zungendrücker, Fig. 2	<b>26-055-02</b>	1 Tounge depressor, Fig. 2	<b>26-055-02</b>
1 Zungendrücker, Fig. 3	<b>26-055-03</b>	1 Tounge depressor, Fig. 3	<b>26-055-03</b>
1 Zungendrücker, Fig. 4	<b>26-055-04</b>	1 Tounge depressor, Fig. 4	<b>26-055-04</b>
1 Zungendrücker, Fig. 5	<b>26-055-05</b>	1 Tounge depressor, Fig. 5	<b>26-055-05</b>

Completo, compuesto de:

Completo, composto da:

1 Bastidor	<b>26-041-00</b>	1 Telaio	<b>26-041-00</b>
1 Bajalengua, Fig. 1	<b>26-055-01</b>	1 Abassalingua, Fig. 1	<b>26-055-01</b>
1 Bajalengua, Fig. 2	<b>26-055-02</b>	1 Abassalingua, Fig. 2	<b>26-055-02</b>
1 Bajalengua, Fig. 3	<b>26-055-03</b>	1 Abassalingua, Fig. 3	<b>26-055-03</b>
1 Bajalengua, Fig. 4	<b>26-055-04</b>	1 Abassalingua, Fig. 4	<b>26-055-04</b>
1 Bajalengua, Fig. 5	<b>26-055-05</b>	1 Abassalingua, Fig. 5	<b>26-055-05</b>



**26-055-01**

25 x 19 mm

**26-055-02**

62 x 25 mm

**26-055-03**

75 x 25 mm

**26-055-04**

92 x 25 mm

**26-055-05**

108 x 25 mm



## DAVIS-BOYLE

**26-040-91** SET

Komplett, bestehend aus:

Complete, consisting of:

1 Rahmen	<b>26-041-00</b>	1 Frame	<b>26-041-00</b>
1 Zungendrücker, Fig. 1	<b>26-055-01</b>	1 Tounge depressor, Fig. 1	<b>26-055-01</b>
1 Zungendrücker, Fig. 2	<b>26-056-02</b>	1 Tounge depressor, Fig. 2	<b>26-056-02</b>
1 Zungendrücker, Fig. 3	<b>26-056-03</b>	1 Tounge depressor, Fig. 3	<b>26-056-03</b>
1 Zungendrücker, Fig. 4	<b>26-056-04</b>	1 Tounge depressor, Fig. 4	<b>26-056-04</b>
1 Zungendrücker, Fig. 5	<b>26-056-05</b>	1 Tounge depressor, Fig. 5	<b>26-056-05</b>

Completo, compuesto de:

Completo, composto da:

1 Bastidor	<b>26-041-00</b>	1 Telaio	<b>26-041-00</b>
1 Bajalengua, Fig. 1	<b>26-055-01</b>	1 Abassalingua, Fig. 1	<b>26-055-01</b>
1 Bajalengua, Fig. 2	<b>26-056-02</b>	1 Abassalingua, Fig. 2	<b>26-056-02</b>
1 Bajalengua, Fig. 3	<b>26-056-03</b>	1 Abassalingua, Fig. 3	<b>26-056-03</b>
1 Bajalengua, Fig. 4	<b>26-056-04</b>	1 Abassalingua, Fig. 4	<b>26-056-04</b>
1 Bajalengua, Fig. 5	<b>26-056-05</b>	1 Abassalingua, Fig. 5	<b>26-056-05</b>



**26-055-01**

25 x 19 mm



**26-056-02**

62 x 25 mm



**26-056-03**

75 x 25 mm



**26-056-04**

92 x 25 mm



**26-056-05**

108 x 25 mm



**DAVIS-BOYLE**

**26-040-92 SET**

Komplett, bestehend aus:

Complete, consisting of:

1 Rahmen	<b>26-041-02</b>
1 Zungendrücker, Fig. 1	<b>26-055-01</b>
1 Zungendrücker, Fig. 2	<b>26-055-02</b>
1 Zungendrücker, Fig. 3	<b>26-055-03</b>
1 Zungendrücker, Fig. 4	<b>26-055-04</b>
1 Zungendrücker, Fig. 5	<b>26-055-05</b>

1 Frame	<b>26-041-02</b>
1 Tounge depressor, Fig. 1	<b>26-055-01</b>
1 Tounge depressor, Fig. 2	<b>26-055-02</b>
1 Tounge depressor, Fig. 3	<b>26-055-03</b>
1 Tounge depressor, Fig. 4	<b>26-055-04</b>
1 Tounge depressor, Fig. 5	<b>26-055-05</b>

Completo, compuesto de:

Completo, composto da:

1 Bastidor	<b>26-041-02</b>
1 Bajalengua, Fig. 1	<b>26-055-01</b>
1 Bajalengua, Fig. 2	<b>26-055-02</b>
1 Bajalengua, Fig. 3	<b>26-055-03</b>
1 Bajalengua, Fig. 4	<b>26-055-04</b>
1 Bajalengua, Fig. 5	<b>26-055-05</b>

1 Telaio	<b>26-041-02</b>
1 Abassalingua, Fig. 1	<b>26-055-01</b>
1 Abassalingua, Fig. 2	<b>26-055-02</b>
1 Abassalingua, Fig. 3	<b>26-055-03</b>
1 Abassalingua, Fig. 4	<b>26-055-04</b>
1 Abassalingua, Fig. 5	<b>26-055-05</b>



**26-055-01**  
25 x 19 mm

**26-055-02**  
62 x 25 mm

**26-055-03**  
75 x 25 mm

**26-055-04**  
92 x 25 mm

**26-055-05**  
108 x 25 mm



## DAVIS-BOYLE

**26-040-93** SET

Komplett, bestehend aus:

Complete, consisting of:

1 Rahmen	<b>26-041-02</b>	1 Frame	<b>26-041-02</b>
1 Zungendrucker, Fig. 1	<b>26-055-01</b>	1 Tounge depressor, Fig. 1	<b>26-055-01</b>
1 Zungendrucker, Fig. 2	<b>26-056-02</b>	1 Tounge depressor, Fig. 2	<b>26-056-02</b>
1 Zungendrucker, Fig. 3	<b>26-056-03</b>	1 Tounge depressor, Fig. 3	<b>26-056-03</b>
1 Zungendrucker, Fig. 4	<b>26-056-04</b>	1 Tounge depressor, Fig. 4	<b>26-056-04</b>
1 Zungendrucker, Fig. 5	<b>26-056-05</b>	1 Tounge depressor, Fig. 5	<b>26-056-05</b>

Completo, compuesto de:

Completo, composto da:

1 Bastidor	<b>26-041-02</b>	1 Telaio	<b>26-041-02</b>
1 Bajalengua, Fig. 1	<b>26-055-01</b>	1 Abassalingua, Fig. 1	<b>26-055-01</b>
1 Bajalengua, Fig. 2	<b>26-056-02</b>	1 Abassalingua, Fig. 2	<b>26-056-02</b>
1 Bajalengua, Fig. 3	<b>26-056-03</b>	1 Abassalingua, Fig. 3	<b>26-056-03</b>
1 Bajalengua, Fig. 4	<b>26-056-04</b>	1 Abassalingua, Fig. 4	<b>26-056-04</b>
1 Bajalengua, Fig. 5	<b>26-056-05</b>	1 Abassalingua, Fig. 5	<b>26-056-05</b>



**26-055-01**

25 x 19 mm



**26-056-02**

62 x 25 mm



**26-056-03**

75 x 25 mm



**26-056-04**

92 x 25 mm



**26-056-05**

108 x 25 mm

drehbar  
rotatable  
giratorio  
girevole



**DAVIS-BOYLE**

**26-041-01**

für Kinder  
for children  
para niños  
per bambini



**DAVIS-BOYLE**

**26-042-00**

für Jugendliche  
for teenager  
para adolescente  
per giovinetto



**DAVIS-BOYLE**

**26-043-00**

für Jugendliche  
for teenager  
para adolescente  
per giovinetto



**DAVIS-BOYLE**

**26-043-01**



## KILNER-DOUGHTY

**26-044-00** SET

Komplett, bestehend aus:

Complete, consisting of:

1 Rahmen	<b>26-044-19</b>
1 Zungendrucker, Fig. 1	<b>26-050-01</b>
1 Zungendrucker, Fig. 2	<b>26-050-02</b>
1 Zungendrucker, Fig. 3	<b>26-050-03</b>
1 Gaumenplatte	<b>26-044-02</b>

1 Frame	<b>26-044-19</b>
1 Tounge depressor, Fig. 1	<b>26-050-01</b>
1 Tounge depressor, Fig. 2	<b>26-050-02</b>
1 Tounge depressor, Fig. 3	<b>26-050-03</b>
1 Gaumenplatte	<b>26-044-02</b>

Completo, compuesto de:

Completo, composto da:

1 Bastidor	<b>26-044-19</b>
1 Bajalengua, Fig. 1	<b>26-050-01</b>
1 Bajalengua, Fig. 2	<b>26-050-02</b>
1 Bajalengua, Fig. 3	<b>26-050-03</b>
1 Plaquita paladia	<b>26-044-02</b>

1 Telaio	<b>26-044-19</b>
1 Abassalingua, Fig. 1	<b>26-050-01</b>
1 Abassalingua, Fig. 2	<b>26-050-02</b>
1 Abassalingua, Fig. 3	<b>26-050-03</b>
1 Placca per palato	<b>26-044-02</b>



**26-050-01**

65 x 28 mm



**26-050-02**

75 x 32 mm



**26-050-03**

80 x 37 mm



**26-044-02**



**MC IVOR**

**26-045-01** SET

Komplett, bestehend aus:

Complete, consisting of:

1 Rahmen	<b>26-045-00</b>
1 Zungendrücker, Fig. 1	<b>26-054-01</b>
1 Zungendrücker, Fig. 2	<b>26-054-02</b>
1 Zungendrücker, Fig. 3	<b>26-054-03</b>

1 Frame	<b>26-045-00</b>
1 Tounge depressor, Fig. 1	<b>26-054-01</b>
1 Tounge depressor, Fig. 2	<b>26-054-02</b>
1 Tounge depressor, Fig. 3	<b>26-054-03</b>

Completo, compuesto de:

Completo, composto da:

1 Bastidor	<b>26-045-00</b>
1 Bajalengua, Fig. 1	<b>26-054-01</b>
1 Bajalengua, Fig. 2	<b>26-054-02</b>
1 Bajalengua, Fig. 3	<b>26-054-03</b>

1 Telaio	<b>26-045-00</b>
1 Abassalingua, Fig. 1	<b>26-054-01</b>
1 Abassalingua, Fig. 2	<b>26-054-02</b>
1 Abassalingua, Fig. 3	<b>26-054-03</b>



**26-054-01**

70 x 23 mm

**26-054-02**

86 x 25 mm

**26-054-03**

100 x 26 mm





### DINGMANN

<b>26-035-01</b>	65 x 25 mm
<b>26-035-02</b>	70 x 29 mm
<b>26-035-03</b>	80 x 32 mm



### DOUGHTY

<b>26-048-01</b>	65 mm
<b>26-048-02</b>	75 mm
<b>26-048-03</b>	90 mm
<b>26-048-04</b>	102 mm
<b>26-048-05</b>	115 mm



<b>26-049-01</b>	65 mm
<b>26-049-02</b>	75 mm
<b>26-049-03</b>	90 mm
<b>26-049-04</b>	102 mm



### RUSSEL-DAVIS

<b>26-050-01</b>	65 x 28 mm
<b>26-050-02</b>	75 x 32 mm
<b>26-050-03</b>	80 x 37 mm
<b>26-050-04</b>	94 x 41 mm
<b>26-050-05</b>	103 x 46 mm



### RUSSEL-DAVIS

<b>26-051-01</b>	57 x 18 mm
<b>26-051-02</b>	67 x 22 mm
<b>26-051-03</b>	75 x 25 mm



### GAST

<b>26-052-01</b>	64 x 28 mm
<b>26-052-02</b>	74 x 34 mm
<b>26-052-03</b>	87 x 38 mm
<b>26-052-04</b>	95 x 40 mm
<b>26-052-05</b>	103 x 45 mm



**DAVIS-MEYER**

<b>26-053-01</b>	70 x 29 mm
<b>26-053-02</b>	75 x 30 mm
<b>26-053-03</b>	80 x 31 mm
<b>26-053-04</b>	85 x 32 mm
<b>26-053-05</b>	95 x 33 mm
<b>26-053-06</b>	100 x 33 mm
<b>26-053-07</b>	105 x 34 mm



**MC IVOR**

<b>26-054-01</b>	70 x 23 mm
<b>26-054-02</b>	86 x 25 mm
<b>26-054-03</b>	100 x 26 mm



**MC IVOR**

<b>26-054-11</b>	70 x 23 mm
<b>26-054-12</b>	86 x 25 mm
<b>26-054-13</b>	100 x 26 mm



**DAVIS-BOYLE**

<b>26-055-02</b>	65 x 22 mm
<b>26-055-03</b>	75 x 25 mm
<b>26-055-04</b>	92 x 25 mm
<b>26-055-05</b>	108 x 25 mm



**DAVIS-BOYLE**

<b>26-055-01</b>	25 x 19 mm
<b>26-056-02</b>	65 x 25 mm
<b>26-056-03</b>	75 x 25 mm
<b>26-056-04</b>	92 x 25 mm
<b>26-056-05</b>	108 x 25 mm



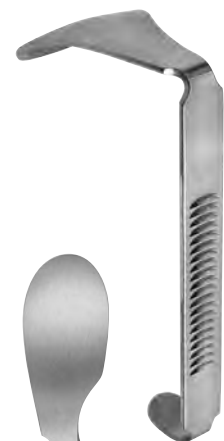
**WUERZBURG**

<b>26-057-01</b>	66 x 28 mm
<b>26-057-02</b>	75 x 32 mm
<b>26-057-03</b>	83 x 34 mm
<b>26-057-04</b>	93 x 37 mm
<b>26-057-05</b>	100 x 38 mm



**RING**

<b>26-058-02</b>	58 x 23 mm
<b>26-058-03</b>	72 x 27 mm
<b>26-058-04</b>	87 x 34 mm
<b>26-058-05</b>	95 x 37 mm



**HERBERHOLD**

<b>26-059-01</b>	75 x 32 mm
<b>26-059-02</b>	83 x 34 mm
<b>26-059-03</b>	93 x 37 mm
<b>26-059-04</b>	100 x 38 mm



Bruststütze für alle Mundsperrer  
 Chest support for all mouth gags  
 Soporte de pecho para todos los abre bocas  
 Supporto sternale per tutti gli apribocca



## NEGUS

**26-060-00** 140 mm

**26-060-01** 110 mm

**26-060-02** 85 mm

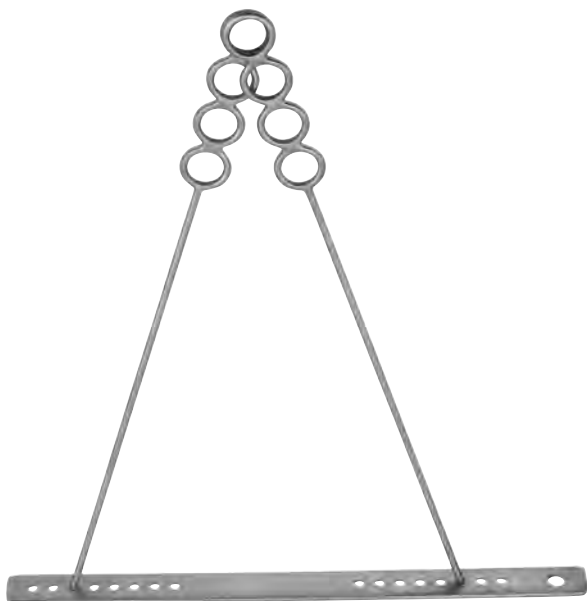
Band zur Befestigung der NEGUS Bruststütze  
 Band to fix the NEGUS chest support  
 Banda para la sujeción del apoyo pectoral NEGUS  
 Fascia per il fissaggio del supporto petto NEGUS



## NEGUS

**26-060-05**

Halterahmen für Mundsperrer  
 Holding frame for mouth gags  
 Bastidor de soporte para abre bocas  
 Supporto per gli apribocca



## DRAFFIN

**26-060-92**

## DRAFFIN

**26-060-90**

Ersatz Stangen, 2 Stück  
 Spare bars, 2 pcs.  
 Barras de repuesto, 2 unidades  
 Asta di ricambio, 2 pezzi

## DRAFFIN

**26-060-91**

Ersatz Halteplatte  
 Spare holding plate  
 Placa de soporte de repuesto  
 Piastra di supporto di ricambio



**CAWOOD-MINNESOTA**

**26-069-15** 15,0 cm, 6 "



**STERNBERG**

**26-070-12** 12,0 cm, 4 ¾ "  
**26-070-14** 14,0 cm, 5 ½ "  
**26-070-16** 16,0 cm, 6 ¼ "



**26-071-19** 19,0 cm, 7 ½ "



**COLLIN**

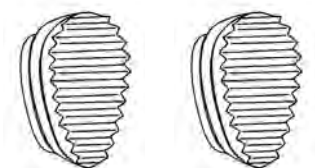
**26-072-16** 16,0 cm, 6 ¼ "  
**26-072-18** 18,0 cm, 7 "



**YOUNG**

**26-073-16** 16,0 cm, 6 ¼ "

Ersatz Gummipolster für 26-073-16  
 Spare rubber Inserts for 26-073-16  
 Bocas de goma de repuesto para 26-073-16  
 Cuscino di gomma di ricambio per 26-073-16



**YOUNG**

**26-073-99**



### SIMPLEX

**26-074-11** 10,5 cm, 4 ¼"

Fig. 1  
**26-075-01**

Fig. 2  
**26-075-02**

1 Paar  
 Set of 2  
 Juego de 2  
 Confezione da 2

Fig. 3  
**26-075-03**



### MC KESSON

**26-075-01 - 26-075-03**

Mundkeil, aus Holz  
 Oral screw, made of wood  
 Tornillo oral, en madera  
 Apribocca elicoidale in legno

Ø 32,0 mm



### MAUNDER

**26-075-10** 9,5 cm, 3 ¾"

Mundkeil, aus Silikon  
 Oral screw, made of silicone  
 Tornillo oral, en silicona  
 Apribocca elicoidale in silicona



### PITHA

**26-076-10** 28 x 30 mm



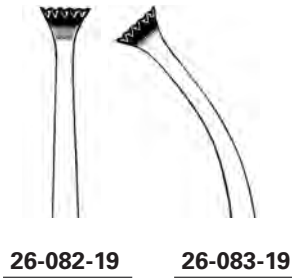
### ADAMS

**26-077-00** 28 x 30 mm



### LANGENBECK

**26-079-01** Ø 17 - 21 mm  
**26-079-02** Ø 19 - 24 mm  
**26-079-03** Ø 21 - 26 mm



**CLOVER**

26-082-19 - 26-083-19 19,0 cm, 7 1/2"



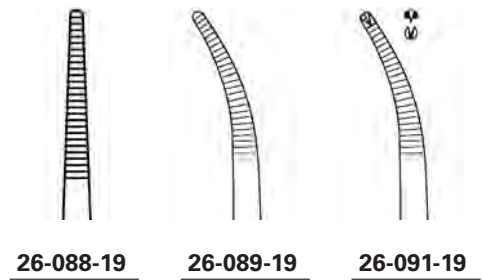
**WHITE**

26-085-18 18,0 cm, 7"  
26-085-23 23,0 cm, 9"



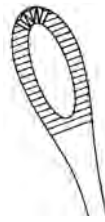
**SAWTELL**

26-087-18 19,0 cm, 7 1/2"



**SCHNIDT**

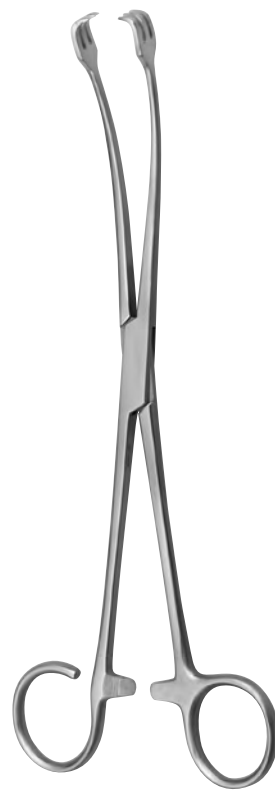
26-088-19 - 26-091-19 19,5 cm, 7 3/4"



**26-093-20**

**BLOHMKE**

**26-093-20** 20,0 cm, 8"



**BALLENGER**

**26-094-21** 21,5 cm, 8 1/2"



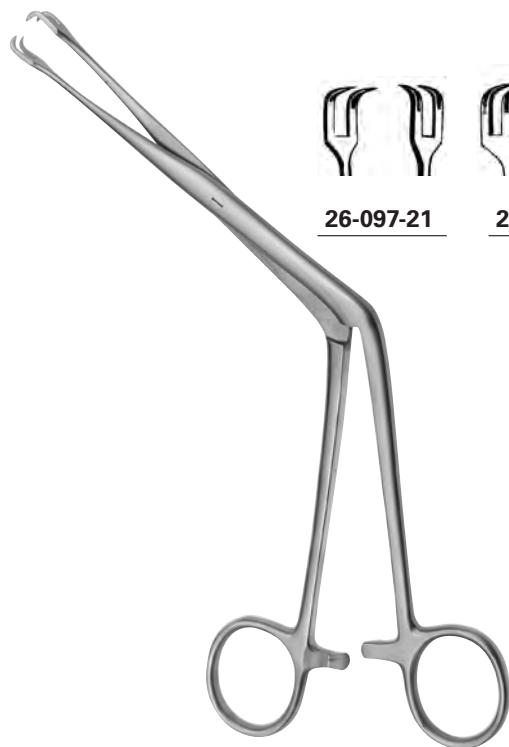
**MARSCHIK-KRONE**

**26-095-20** 20,0 cm, 8"



**MARSCHIK**

**26-096-22** 22,0 cm, 8 3/4"



**26-097-21**



**26-097-22**

**TYDING-TIVNEN**

**26-097-21 - 26-097-22** 21,0 cm, 8 1/4"



**ABRAHAM**

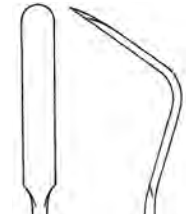
**26-098-20** 20,5 cm, 8"



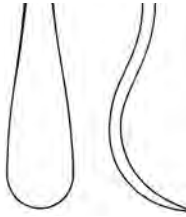
mit Absaugvorrichtung  
with suction device  
con succión  
con aspiratore

**LOPEZ-REINKE**

**26-099-23** 23,5 cm, 9 ¼ "



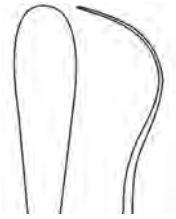
**26-100-01**



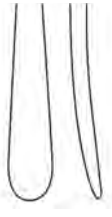
Tonsillenmesser und Enucleator  
Tonsil knife and enucleator  
Cuchillo y enucleador para amígdalas  
Bisturi enucleatore per tonsille

**CARPENTER**

**26-100-01** 25,0 cm, 9 ¾ "



**26-100-02**



**CARPENTER**

**26-100-02** 24,0 cm, 9 ½ "



12 mm

**26-101-01**

6 mm



14 mm

**26-101-02**

10 mm



14 mm

**26-101-03**

9 mm



**HURD**

**26-101-01 - 26-101-03** 21,5 cm, 8 ½ "



12 mm

**26-102-01**



17 mm

**26-102-02**



**HENKE**

**26-102-01 - 26-102-02** 23,5 cm, 9 ¼ "



Tonsillennmesser, Tonsillenschnürer  
 Tonsil knives, Tonsil snares  
 Bisturís para amígdalas, Cierra-nudos para amígdalas  
 Bisturi per tonsille, Serranodi per tonsille



**26-103-06** 6,0 mm  
**26-103-08** 8,0 mm



mit Schutzhülse  
 with protection shield  
 con funda protectora  
 con guaina protettiva

**GWYNE-EVANS**

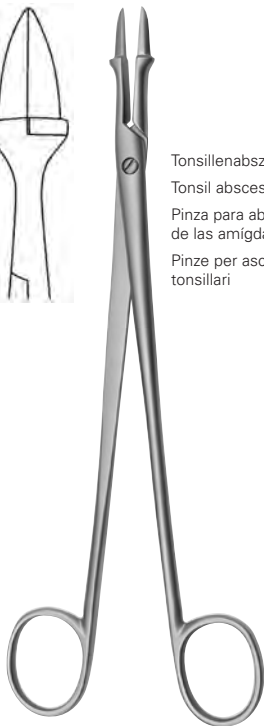
**26-103-06 - 26-103-08** 20,0 cm, 8 "

**FISCHER**

**26-109-20** 20,5 cm, 8 "



Tonsillenabszesszange  
 Tonsil abscess forceps  
 Pinza para abscesos  
 de las amígdalas  
 Pinze per ascessi  
 tonsillari



ohne Raste  
 without ratchet  
 sin cremallera  
 senza cremagliera

**EVES**

**26-150-26** 28,0 cm, 11 "



mit Raste  
 with ratchet  
 con cremallera  
 con cremagliera

**EVES**

**26-152-25** 28,0 cm, 11 "



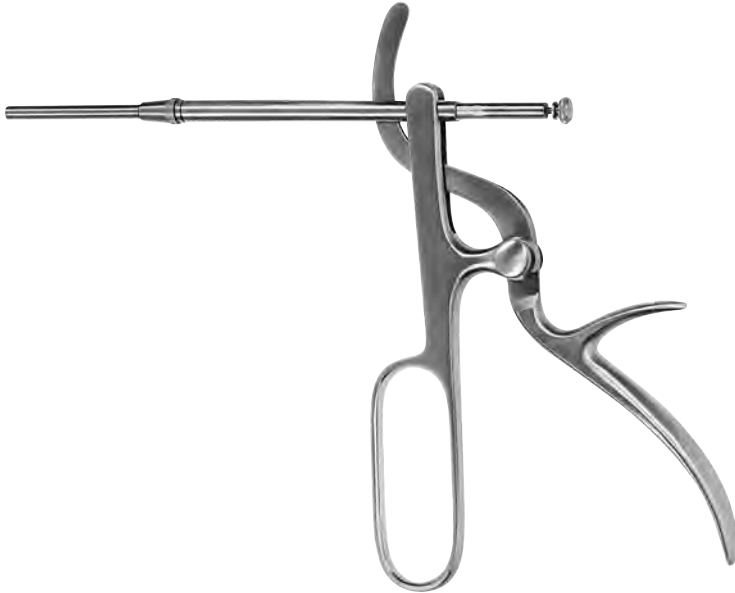
mit Raste  
 with ratchet  
 con cremallera  
 con cremagliera

**BRUENINGS**

**26-154-27** 27,0 cm, 10 3/4 "

**THILENIUS**

**26-110-19** 19,0 cm, 7 1/2 "



**TYDING**

**26-155-00**



**TYDING**

**26-155-01**

gerader Aufsatz allein  
straight tip only  
punta recta suelto  
punta diritta solo



**VEEDER**

**26-155-02**

Aufsatz allein  
Tip only  
Punta suelto  
Punta solo



Verpackungseinheit: 12 St.  
Packing unit: 12 pieces  
Unidad: 12 piezas  
Confezione: 12 pezzi

Schnürdrähte  
Snare wires  
Alambre para amigdalótomo  
Filo per serranodi



Verpackungseinheit: 100 St.  
Packing unit: 100 pieces  
Unidad: 100 piezas  
Confezione: 100 pezzi

Schnürdrähte  
Snare wires  
Alambre para amigdalótomo  
Filo per serranodi



Verpackungseinheit: 100 St.  
Packing unit: 100 pieces  
Unidad: 100 piezas  
Confezione: 100 pezzi

Drahtschlingen  
Wire loops  
Asas de alambre  
Laccio per serranodi

Schnürdrähte, Rolle mit 10 m  
Snare wires, coil of 10 m  
Alambre para amigdalótomo, rollo de 10 m  
Filo per serranodi, rotolo da 10 m



**26-156-03** Ø 0,3 mm  
**26-156-05** Ø 0,5 mm



**26-156-13** Ø 0,3 mm  
**26-156-14** Ø 0,4 mm  
**26-156-15** Ø 0,5 mm



**26-157-04** Ø 0,4 | 40 mm  
**26-157-05** Ø 0,4 | 50 mm



**26-158-02** Ø 0,2 mm  
**26-158-03** Ø 0,3 mm  
**26-158-04** Ø 0,4 mm



## SLUDER-BALLENGER

**26-159-00** SET

Komplett, bestehend aus:

Complete, consisting of:

1 Griff	<b>26-159-04</b>	1 Handle	<b>26-159-04</b>
1 Aufsatz, Fig. 1	<b>26-159-01</b>	1 Tip, Fig. 1	<b>26-159-01</b>
1 Aufsatz, Fig. 2	<b>26-159-02</b>	1 Tip, Fig. 2	<b>26-159-02</b>
1 Aufsatz, Fig. 3	<b>26-159-03</b>	1 Tip, Fig. 3	<b>26-159-03</b>

Completo, compuesto de:

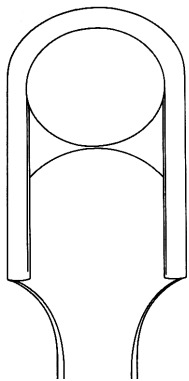
Completo, composto da:

1 Mango	<b>26-159-04</b>	1 Manico	<b>26-159-04</b>
1 Punta, Fig. 1	<b>26-159-01</b>	1 Punta, Fig. 1	<b>26-159-01</b>
1 Punta, Fig. 2	<b>26-159-02</b>	1 Punta, Fig. 2	<b>26-159-02</b>
1 Punta, Fig. 3	<b>26-159-03</b>	1 Punta, Fig. 3	<b>26-159-03</b>

Aufsatz  
Blade  
Punta  
Lama

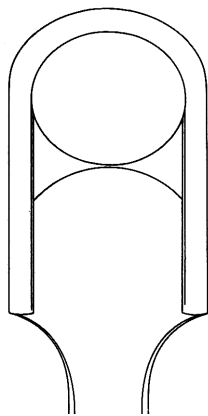
Aufsatz  
Blade  
Punta  
Lama

Aufsatz  
Blade  
Punta  
Lama



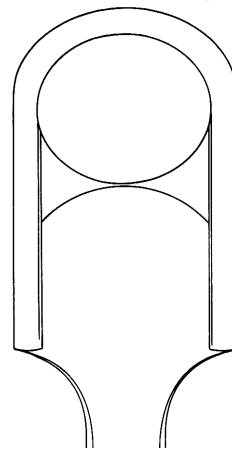
**26-159-01**

Fig. 1



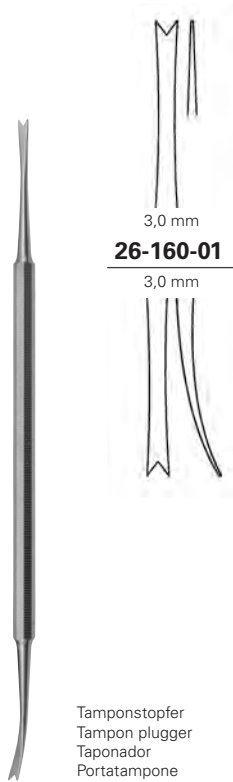
**26-159-02**

Fig. 2



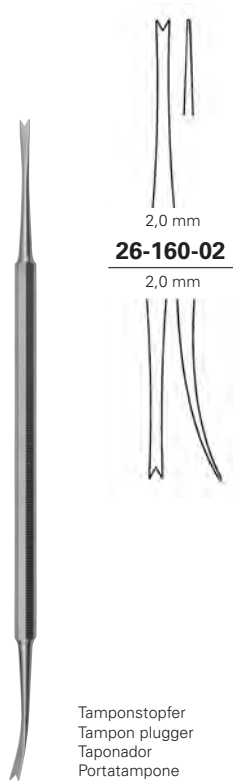
**26-159-03**

Fig. 3



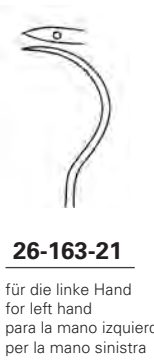
**LUNIATSCHEK**

**26-160-01** 17,5 cm, 7"



**LUNIATSCHEK**

**26-160-02** 17,5 cm, 7"



Gaumennadel  
Cleft palate needle  
Aguja para sutura del paladar  
Aghi per sutura del palato

**HURD**

**26-163-21** 21,0 cm, 8 ¼"



Gaumennadel  
Cleft palate needle  
Aguja para sutura del paladar  
Aghi per sutura del palato

**HURD**

**26-165-21** 21,0 cm, 8 ¼"



Tonsillennadel  
Tonsil needle  
Aguja para amígdalas  
Aghi per tonsille

**CLAUS V. EICKEN**

**26-167-25** 25,0 cm, 9 ¾"



Unterbindungs-nadel  
Ligature needle  
Aguja para ligaduras  
Aghi per legatura

**DUPUY-WEISS**

**26-169-22** 22,0 cm, 8"



Unterbindungs-nadel  
Ligature needle  
Aguja para ligaduras  
Aghi per legatura

**DUPUY-WEISS**

**26-171-22** 22,0 cm, 8"



Ligaturinstrument  
Ligature instrument  
Cierra-nudos para amígdalas  
Serranodi per tonsille

### ROEDER

**26-172-26** 26,5 cm, 10 1/2"



Fadenfänger  
Ligature catcher  
Captador de hilos  
Portalegature

### HOEN V. EICKEN

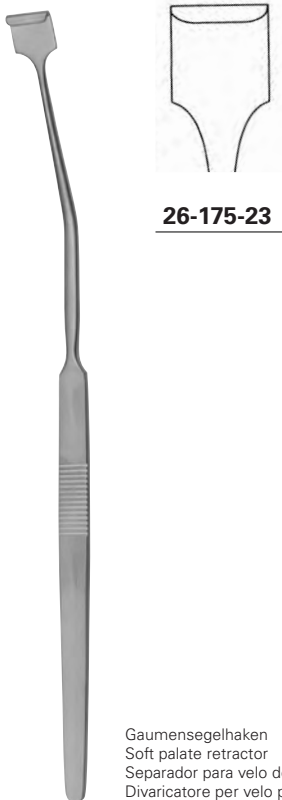
**26-173-21** 21,0 cm, 8 1/4"

Gaumensegelhalter  
Soft palate retractor  
Separador para velo del paladar  
Divaricatore per velo pendulo



### HASLINGER

**26-174-00** 17,0 cm, 6 3/4"



**26-175-23**

Gaumensegelhaken  
Soft palate retractor  
Separador para velo del paladar  
Divaricatore per velo pendulo

### NAGER

**26-175-23** 24,0 cm, 9 1/2"



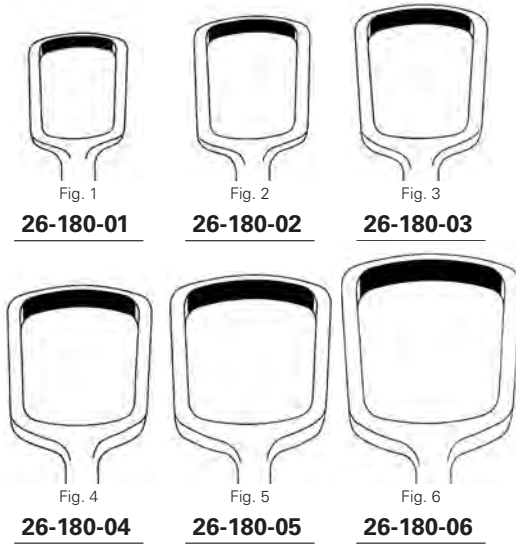
**26-176-18** 18 mm

**26-176-20** 20 mm

**26-176-22** 22 mm

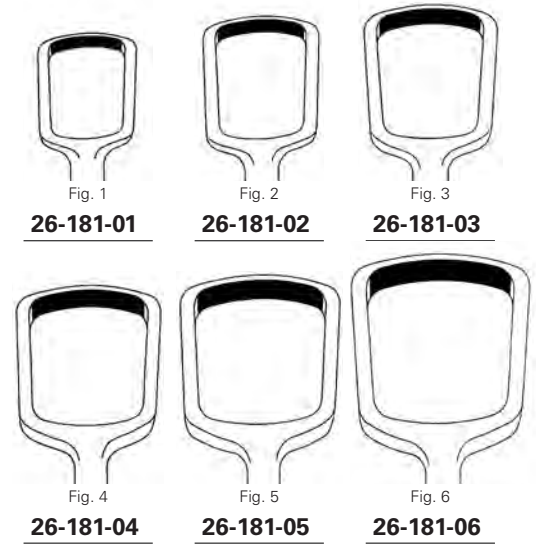
### LOVE

**26-176-18 - 26-176-22** 15,0 cm, 6"



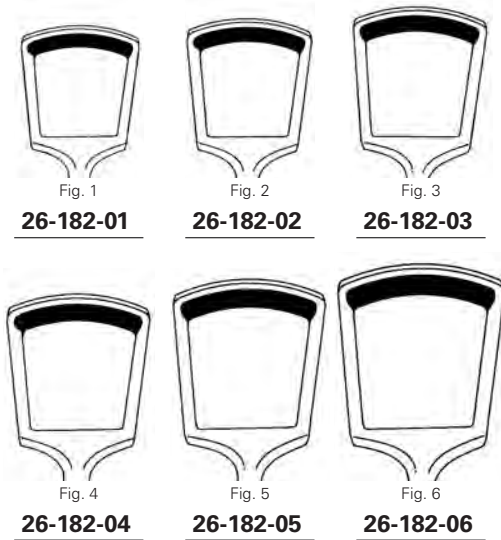
**BECKMANN**

**26-180-01 - 26-180-06** 22,5 cm, 9"



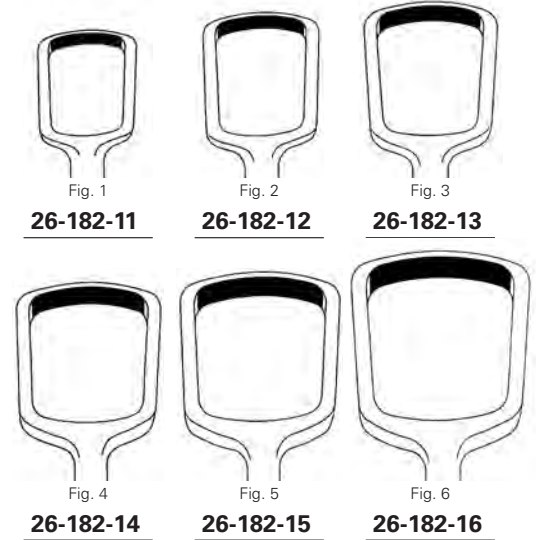
**BECKMANN**

**26-181-01 - 26-181-06** 22,5 cm, 9"



**BECKMANN**

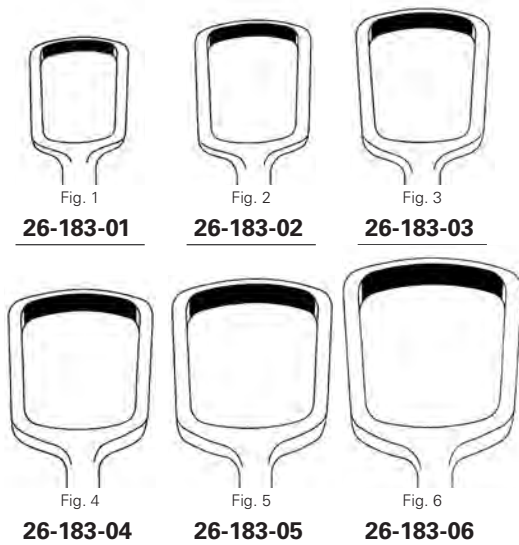
**26-182-01 - 26-182-06** 22,5 cm, 9"



mit Fangkorb  
with basket  
con cesto  
con raccogliore

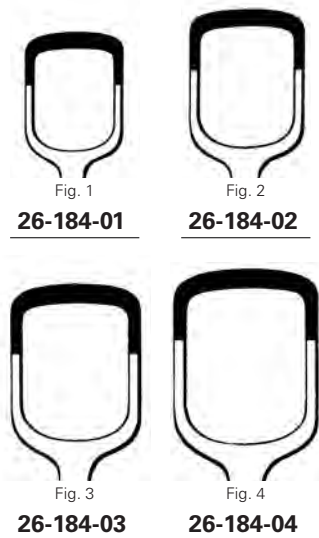
**BECKMANN**

**26-182-11 - 26-182-16** 22,5 cm, 9"



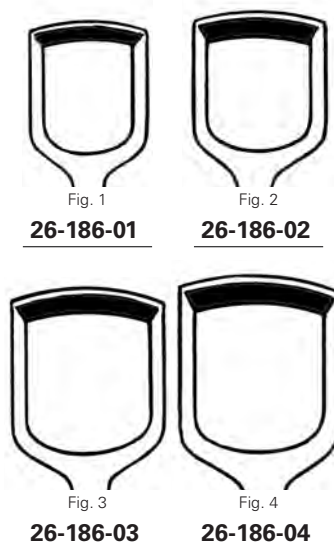
### NEGUS

**26-183-01 - 26-183-06** 22,5 cm, 9"



### BARNHILL

**26-184-01 - 26-184-04** 20,0 cm, 8"



mit Fangkorb  
 with basket  
 con cesto  
 con raccogliore

### ST. CLAIR-THOMSON

**26-186-01 - 26-186-04** 21,0 cm, 8 ¼"

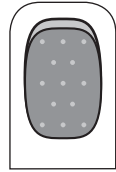


Fig. 1

**26-187-01**

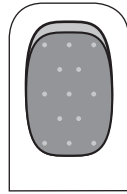


Fig. 2

**26-187-02**

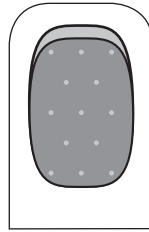


Fig. 3

**26-187-03**

**26-187-11** Fig. 1 | 12 mm

**26-187-12** Fig. 2 | 16 mm

**26-187-13** Fig. 3 | 18 mm

Ersatzklingen, gelocht  
Spare Blades, perforated  
Hojas de repuesto, perforada  
Lama di ricambio, perforate

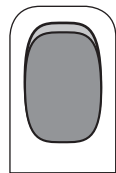


Fig. 1

**26-187-04**

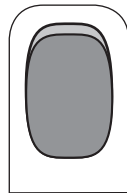


Fig. 2

**26-187-05**

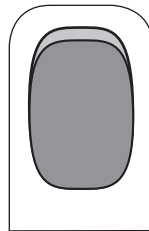


Fig. 3

**26-187-06**

**26-187-14** Fig. 1 | 12 mm

**26-187-15** Fig. 2 | 16 mm

**26-187-16** Fig. 3 | 18 mm

Ersatzklingen, ungelocht  
Spare Blades, non perforated  
Hojas de repuesto, no perforada  
Lama di ricambio, non perforate

## LA FORCE

**26-187-01 - 26-187-06** 23,0 cm, 9"

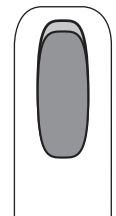


Fig. 0

**26-188-00**

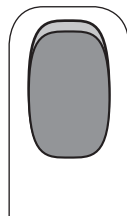


Fig. 1

**26-188-01**

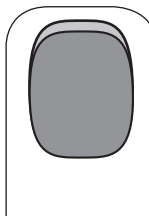


Fig. 2

**26-188-02**

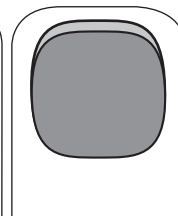


Fig. 3

**26-188-03**

**26-188-10** Fig. 0 | 10 mm

**26-188-11** Fig. 1 | 13 mm

**26-188-12** Fig. 2 | 16 mm

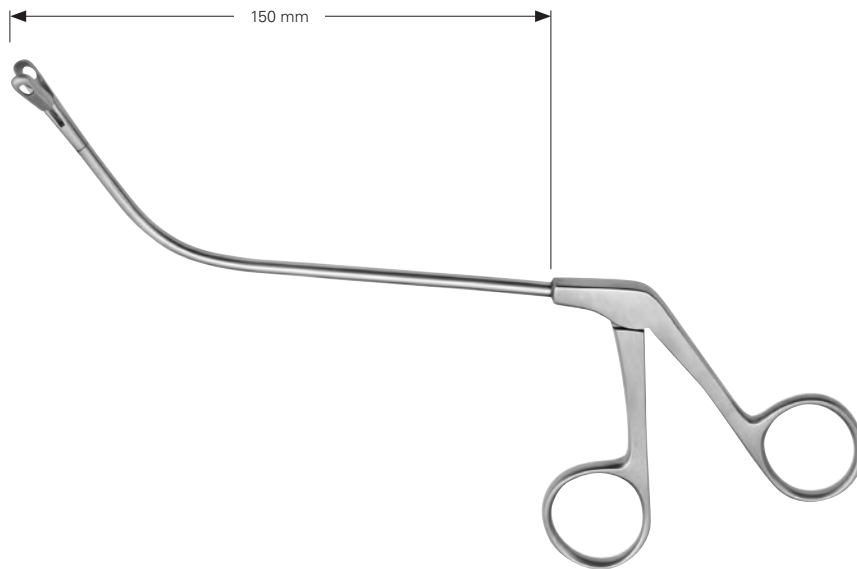
**26-188-13** Fig. 3 | 19 mm

Ersatzklingen, ungelocht  
Spare Blades, non perforated  
Hojas de repuesto, no perforada  
Lama di ricambio, non perforate

## SHAMBOUGH

**26-188-00 - 26-188-03** 23,0 cm, 9"





### JATHO

**26-193-24** 24,0 cm, 9 ½"

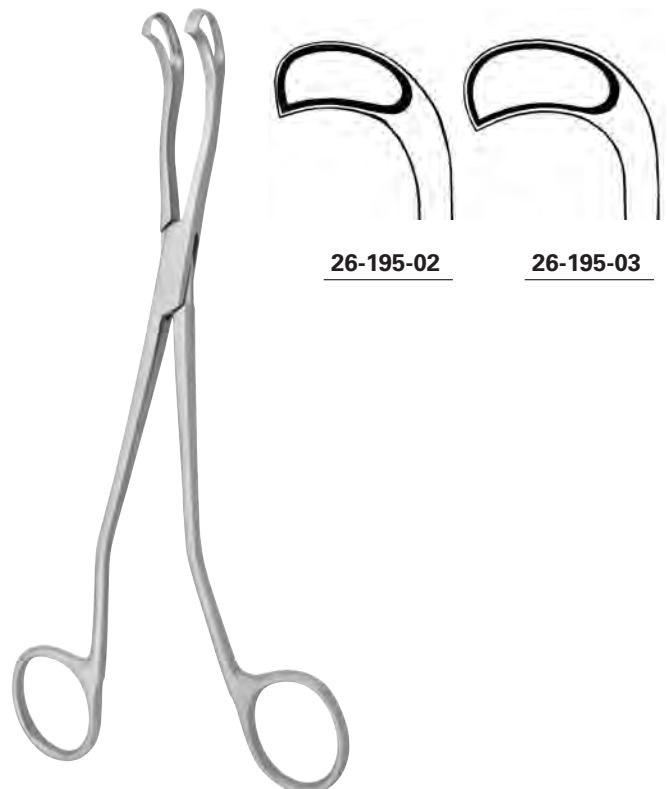


**26-195-01**

für Kinder  
for children  
para niños  
per bambini

### JURASZ

**26-195-01** 19,0 cm, 7 ½"

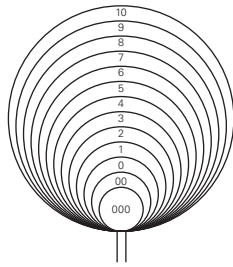


**26-195-02**

**26-195-03**

### JURASZ

**26-195-02 - 26-195-03** 21,0 cm, 8 ¼"



- 26-200-06** 6 mm | Fig. 000
- 26-200-08** 8 mm | Fig. 00
- 26-200-10** 10 mm | Fig. 0
- 26-200-12** 12 mm | Fig. 1
- 26-200-14** 14 mm | Fig. 2
- 26-200-16** 16 mm | Fig. 3
- 26-200-18** 18 mm | Fig. 4
- 26-200-20** 20 mm | Fig. 5
- 26-200-22** 22 mm | Fig. 6
- 26-200-24** 24 mm | Fig. 7
- 26-200-26** 26 mm | Fig. 8
- 26-200-28** 28 mm | Fig. 9
- 26-200-30** 30 mm | Fig. 10

Kehlkopfspiegel, ohne Griff  
Laryngeal mirrors, without handle  
Espejos laríngeos, sin mango  
Specchi laringei, senza manico



Metallgriff  
Metal handle  
mango metálico  
Manico metallico

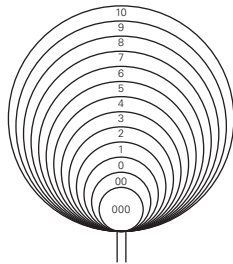


Metallgriff  
Metal handle  
mango metálico  
Manico metallico

**26-200-06 - 26-200-30** 14,0 cm, 5 ½ "

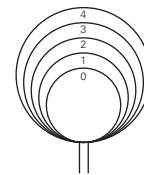
**26-201-00** 10,0 cm, 4 "

**26-202-00** 10,5 cm, 4 ¼ "



- 26-210-06** 6 mm | Fig. 000
- 26-210-08** 8 mm | Fig. 00
- 26-210-10** 10 mm | Fig. 0
- 26-210-12** 12 mm | Fig. 1
- 26-210-14** 14 mm | Fig. 2
- 26-210-16** 16 mm | Fig. 3
- 26-210-18** 18 mm | Fig. 4
- 26-210-20** 20 mm | Fig. 5
- 26-210-22** 22 mm | Fig. 6
- 26-210-24** 24 mm | Fig. 7
- 26-210-26** 26 mm | Fig. 8
- 26-210-28** 28 mm | Fig. 9
- 26-210-30** 30 mm | Fig. 10

Kehlkopfspiegel, mit festem Griff  
Laryngeal mirrors, with fixed handle  
Espejos laríngeos, sin mango fijo  
Specchi laringei, con manico fisso



- 26-230-10** 10 mm | Fig. 0
- 26-230-12** 12 mm | Fig. 1
- 26-230-14** 14 mm | Fig. 2
- 26-230-16** 16 mm | Fig. 3
- 26-230-18** 18 mm | Fig. 4

Rhinoskopiespiegel, beweglich  
Rhinoscopic mirrors, moveable  
Espejos para rinoscopia, movable  
Specchi per rinoscopia, mobili

**26-210-06 - 26-210-30** 19,0 cm, 7 ½ "

**MICHEL**

**26-230-10 - 26-230-18** 25,0 cm, 9 ¾ "



**REICHERT**

**26-241-23** 24,0 cm, 9 1/4 "



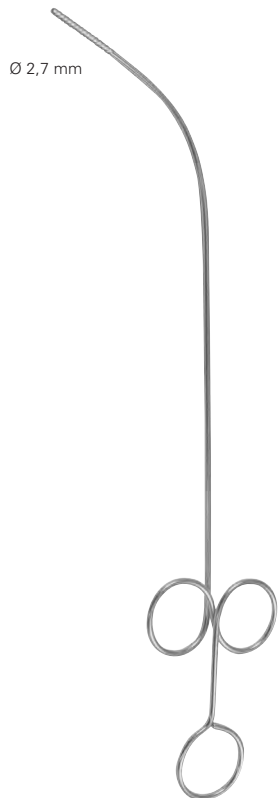
**KILLIAN**

**26-243-25** 25,0 cm, 9 3/4 "



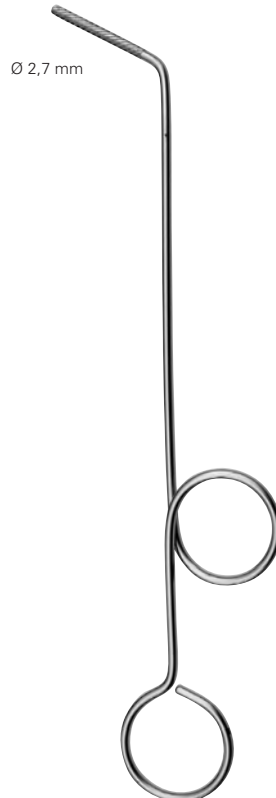
**PELTSON**

**26-245-23** 23,0 cm, 9 "



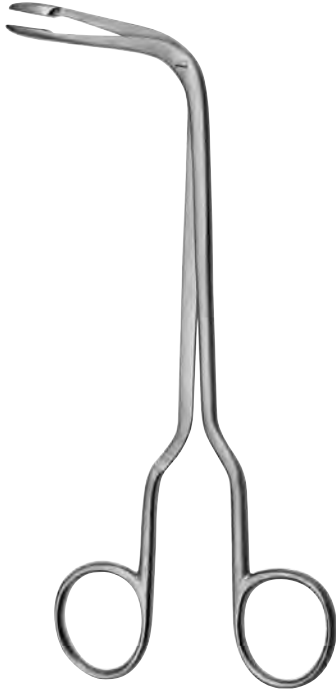
**FEIN**

**26-245-28** 28,0 cm, 11 "



**HARTMANN**

**26-246-22** 22,0 cm, 8 3/4 "



**FRAENKEL**

**26-247-22** 18,0 cm, 7"



**TOBOLD**

**26-249-23** 23,0 cm, 9"



**26-251-01**

rechts  
right  
derecha  
destra

**26-251-02**

links  
left  
izquierda  
sinistra

**26-251-03**

unten  
downwards  
hacia abajo  
verso il basso

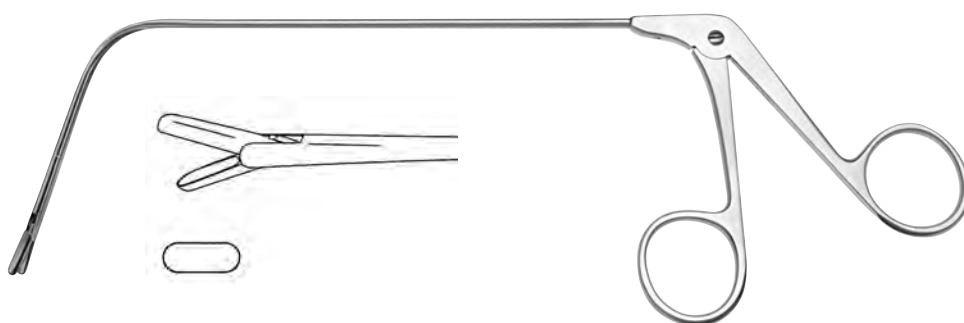
**26-251-04**

oben  
upwards  
hacia arriba  
verso l'alto



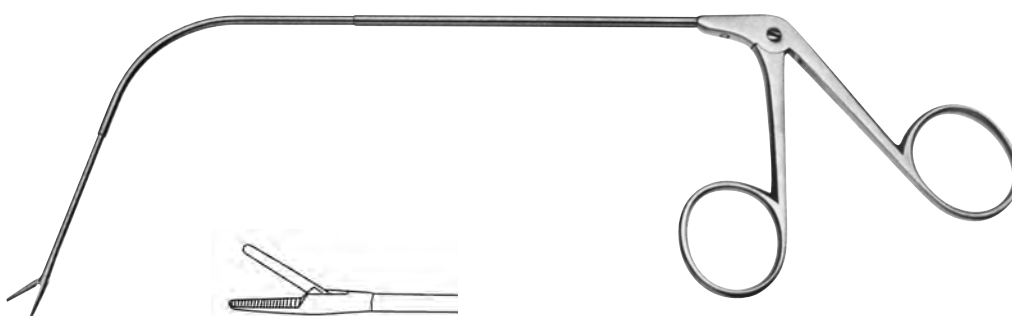
**JURASZ**

**26-251-01 - 26-251-04** 22,0 cm, 8 3/4"



**FRAENKEL**

**26-252-28** 17,0 cm, 6  $\frac{3}{4}$  "



**26-254-28** 17,0 cm, 6  $\frac{3}{4}$  "



Universalgriff  
 Universal Handle  
 Mango universal  
 Manico universale

**HUBER**

**26-262-00**



**BRUENINGS**

<b>26-262-20</b>	200 mm
<b>26-262-30</b>	300 mm
<b>26-262-40</b>	400 mm
<b>26-262-50</b>	500 mm
<b>26-262-60</b>	600 mm

Verlängerungsrohre  
 Elongation tubes  
 Tubos de extensión  
 Tubi di prolungamento



**BRUENINGS**

<b>26-267-20</b>	200 mm
------------------	--------

Verlängerungsrohr  
 Elongation tube  
 Tubo de extensión  
 Tubi di prolungamento



**BRUENINGS**

<b>26-268-20</b>	
------------------	--

Verlängerungsrohr, biegsam  
 Elongation tube, malleable  
 Tubo de extensión, maleable  
 Tubi di prolungamento, malleabili



**FRAENKEL**

**26-270-01**



**SEIFFERT**

**26-270-04**



**BRUENINGS**

**26-270-06** Ø 3,0 mm  
**26-270-07** Ø 4,0 mm



**LANGE**

**26-270-08** Ø 4,0 mm



**BRUENINGS**

**26-270-09** Ø 3,0 mm  
**26-270-10** Ø 4,0 mm



**FRAENKEL**

**26-270-11**



**BRUENINGS**

**26-270-12** 2,5 x 5,0 mm  
**26-270-13** 3,0 x 6,0 mm



**SCHEINMANN**

**26-270-14**



**KRAUSE**

**26-270-15**



**KRAUSE**

**26-270-16**



**KRAUSE**

**26-270-17**



**SCHEINMANN**

**26-270-18**



**SCHUMACHER**

**26-270-19**



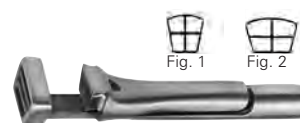
**CORDES**

**26-270-22** 1,0 x 3,0 mm  
**26-270-23** 2,0 x 4,0 mm  
**26-270-24** 3,0 x 5,0 mm



**CORDES**

**26-270-25** 1,0 x 3,0 mm  
**26-270-26** 2,0 x 4,0 mm  
**26-270-27** 3,0 x 5,0 mm  
**26-270-28** 4,0 x 8,0 mm



**CORDES**

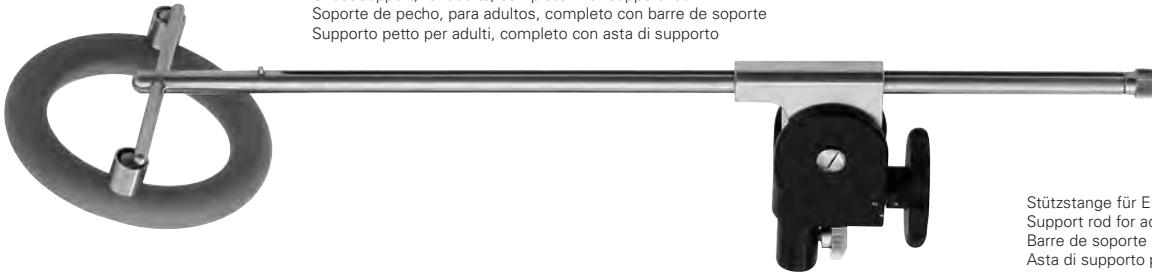
**26-270-30** Fig. 1  
**26-270-31** Fig. 2



**FRAENKEL**

**26-270-33**

Bruststütze, für Erwachsene, komplett mit Stützstange  
 Chest support, for adults, complete with support rod  
 Soporte de pecho, para adultos, completo con barre de soporte  
 Supporto petto per adulti, completo con asta di supporto



Stützstange für Erwachsene  
 Support rod for adults  
 Barre de soporte para adultos  
 Asta di supporto per adulti

**26-280-00** 34,0 cm, 13 3/8 "

**26-280-02** 34,0 cm, 13 3/8 "

Bruststütze, für Kinder, komplett mit Stützstange  
 Chest support, for children, complete with support rod  
 Soporte de pecho, para niños, completo con barre de soporte  
 Supporto petto per bambini, completo con asta di supporto



Stützstange für Kinder  
 Support rod for children  
 Barre de soporte para niños  
 Asta di supporto per bambini

**26-280-10** 24,0 cm, 9 1/2 "

**26-280-01** 24,0 cm, 9 1/2 "



Fig. 1 | Ø 11 mm

**26-282-01**

für Kleinkinder  
 for infants  
 para bebés  
 per noenati



Fig. 2 | Ø 11 mm

**26-282-02**

für Kinder  
 for children  
 para niños  
 per bambini



Fig. 3 | Ø 12 mm

**26-282-03**

für Erwachsene  
 for adults  
 para adultos  
 per adulti



Fig. 4 | Ø 14 mm

**26-282-04**

für Erwachsene  
 for adults  
 para adultos  
 per adulti



Fig. 5 | Ø 16 mm

**26-282-05**

für Erwachsene  
 for adults  
 para adultos  
 per adulti



Fig. 6 | 13x18 mm

**26-282-06**

für Erwachsene  
 for adults  
 para adultos  
 per adulti

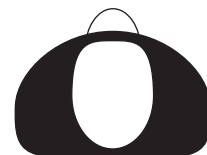


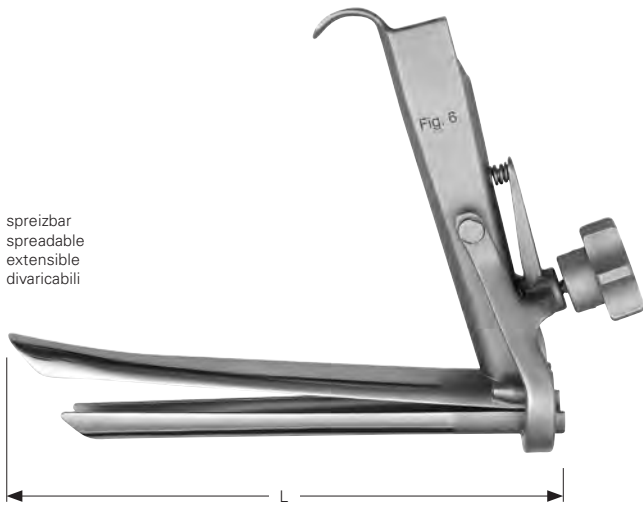
Fig. 7 | 13x18 mm

**26-282-07**

für Erwachsene  
 for adults  
 para adultos  
 per adulti

<b>26-282-01</b>	Fig. 1   135 mm
<b>26-282-02</b>	Fig. 2   152 mm
<b>26-282-03</b>	Fig. 3   182 mm
<b>26-282-04</b>	Fig. 4   172 mm
<b>26-282-05</b>	Fig. 5   172 mm
<b>26-282-06</b>	Fig. 6   182 mm
<b>26-282-07</b>	Fig. 7   222 mm





<b>26-282-11</b>	Fig. 1   135 mm
<b>26-282-12</b>	Fig. 2   152 mm
<b>26-282-13</b>	Fig. 3   182 mm
<b>26-282-14</b>	Fig. 4   172 mm
<b>26-282-15</b>	Fig. 5   172 mm
<b>26-282-16</b>	Fig. 6   182 mm
<b>26-282-17</b>	Fig. 7   222 mm



Fig. 1 | Ø 11 mm

**26-282-11**

für Kleinkinder  
 for infants  
 para bebés  
 per noenati



Fig. 2 | Ø 11 mm

**26-282-12**

für Kinder  
 for children  
 para niños  
 per bambini



Fig. 3 | Ø 12 mm

**26-282-13**

für Erwachsene  
 for adults  
 para adultos  
 per adulti



Fig. 4 | Ø 14 mm

**26-282-14**

für Erwachsene  
 for adults  
 para adultos  
 per adulti



Fig. 5 | Ø 16 mm

**26-282-15**

für Erwachsene  
 for adults  
 para adultos  
 per adulti

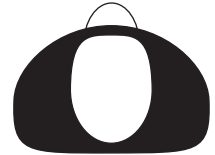


Fig. 6 | 13x18 mm

**26-282-16**

für Erwachsene  
 for adults  
 para adultos  
 per adulti

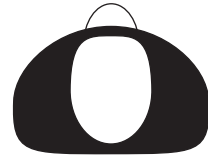


Fig. 7 | 13x18 mm

**26-282-17**

für Erwachsene  
 for adults  
 para adultos  
 per adulti



<b>26-282-21</b>	Fig. 1   135 mm
<b>26-282-22</b>	Fig. 2   152 mm
<b>26-282-23</b>	Fig. 3   182 mm
<b>26-282-24</b>	Fig. 4   172 mm
<b>26-282-25</b>	Fig. 5   172 mm
<b>26-282-26</b>	Fig. 6   182 mm
<b>26-282-27</b>	Fig. 7   222 mm



Fig. 1 | Ø 11 mm

**26-282-21**

für Kleinkinder  
 for infants  
 para bebés  
 per noenati



Fig. 2 | Ø 11 mm

**26-282-22**

für Kinder  
 for children  
 para niños  
 per bambini



Fig. 3 | Ø 12 mm

**26-282-23**

für Erwachsene  
 for adults  
 para adultos  
 per adulti



Fig. 4 | Ø 14 mm

**26-282-24**

für Erwachsene  
 for adults  
 para adultos  
 per adulti



Fig. 5 | Ø 16 mm

**26-282-25**

für Erwachsene  
 for adults  
 para adultos  
 per adulti



Fig. 6 | 13x18 mm

**26-282-26**

für Erwachsene  
 for adults  
 para adultos  
 per adulti



Fig. 7 | 13x18 mm

**26-282-27**

für Erwachsene  
 for adults  
 para adultos  
 per adulti

Fiberglas-Lichtleiter für Laryngoskope 26-282-01 - 26-282-27  
 Fibre optic light carrier for laryngoscope 26-282-01 - 26-282-27  
 Soporte para luz de fibra óptica para laringoscopios 26-282-01 - 26-282-27  
 Conduttore di luce in fibra di vetro per laringoscopia 26-282-01 - 26-282-27



**26-283-01** Fig. 1 - 2

**26-283-02** Fig. 3 - 6

**26-283-03** Fig. 7

Injektionskanüle für Laryngoskope 26-282-01 - 26-282-27  
 Injection cannula for laryngoscopes 26-282-01 - 26-282-27  
 Cánula de inyección para laringoscopia 26-282-01 - 26-282-27  
 Cannula d'iniezione per laringoscopia 26-282-01 - 26-282-27



**26-284-00** Fig. 1 - 7

Rauchabsaugrohr für Laryngoskope 26-282-01 - 26-282-27  
 Vapor suction tube for laryngoscopes 26-282-01 - 26-282-27  
 Cánula de aspiración para vapor para laringoscopia 26-282-01 - 26-282-27  
 Cannula d'aspirazione per vapore per laringoscopia 26-282-01 - 26-282-27



**26-285-00** Fig. 3 - 7



mit festem Rauchabsaugrohr  
 with fixed vapor suction tube  
 con cánula de aspiración para vapor  
 con cannula d'aspirazione per vapore

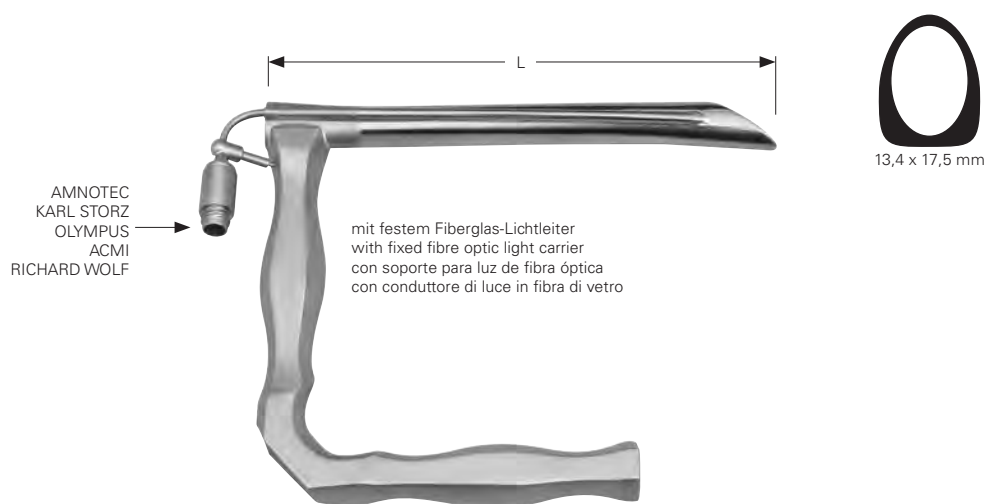


Fig. 7 | Ø 14 mm

**26-282-37**

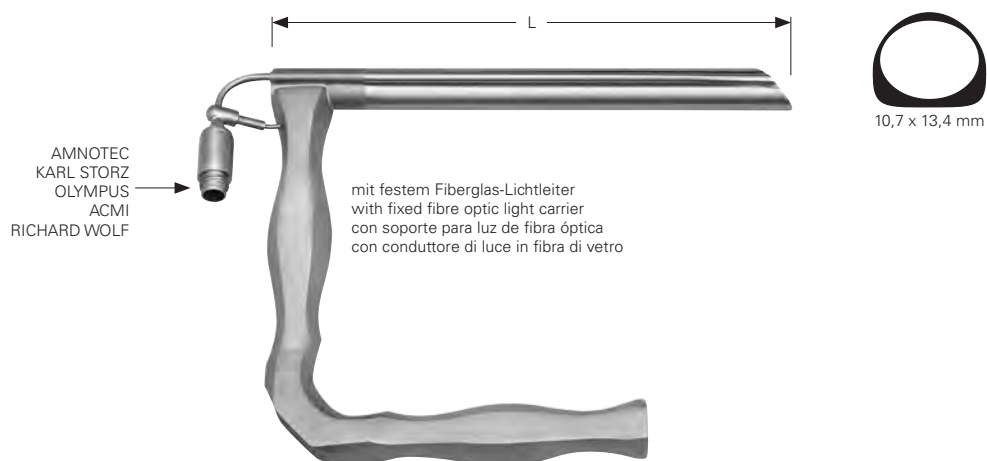
für Erwachsene  
 for adults  
 para adultos  
 per adulti

**26-282-37** Fig. 7 | 140 mm



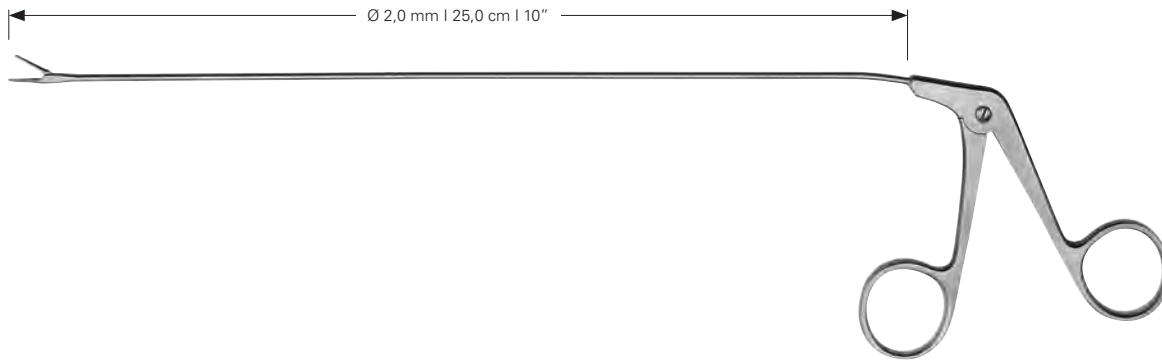
## HOLINGER

<b>26-286-01</b>	Fig. 1   120 mm
<b>26-286-02</b>	Fig. 2   171 mm
<b>26-286-03</b>	Fig. 3   180 mm



## HOLINGER

<b>26-286-11</b>	Fig. 1   120 mm
<b>26-286-12</b>	Fig. 2   171 mm
<b>26-286-13</b>	Fig. 3   180 mm



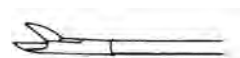
**26-290-01**

Mikro-Faßzange, gerade  
Micro grasping forceps, straight  
Micro-pinza de agarre, recta  
Micropinze da presa, retto



**26-290-04** Ø 2,0 mm

Mikro-Löffelzange, gerade  
Micro cup-shaped forceps, straight  
Micro-pinza en forma de cucharilla, recta  
Micropinze a cucchiaio, retto



**26-290-08**

Mikro-Schere, gerade  
Micro scissors, straight  
Micro-tijeras de agarre, recta  
Microforbici da presa, retto



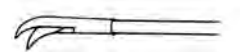
**26-290-02**

Mikro-Faßzange, links gebogen  
Micro grasping forceps, curved left  
Micro-pinza de agarre, curva a la izquierda  
Micropinze da presa, curvo verso sinistra



**26-290-05** Ø 2,0 mm

Mikro-Löffelzange, links gebogen  
Micro cup-shaped forceps, curved left  
Micro-pinza en forma de cucharilla, curva a la izquierda  
Micropinze a cucchiaio, curvo verso sinistra



**26-290-09**

Mikro-Schere, links gebogen  
Micro scissors, curved left  
Micro-tijeras de agarre, curva a la izquierda  
Microforbici da presa, curvo verso sinistra



**26-290-03**

Mikro-Faßzange, rechts gebogen  
Micro grasping forceps, curved right  
Micro-pinza de agarre, curva a la derecha  
Micropinze da presa, curvo verso destra



**26-290-06** Ø 2,0 mm

Mikro-Löffelzange, rechts gebogen  
Micro cup-shaped forceps, curved right  
Micro-pinza en forma de cucharilla, curva a la derecha  
Micropinze a cucchiaio, curvo verso destra



**26-290-10**

Mikro-Schere, rechts gebogen  
Micro scissors, curved right  
Micro-tijeras de agarre, curva a la derecha  
Microforbici da presa, curvo verso destra



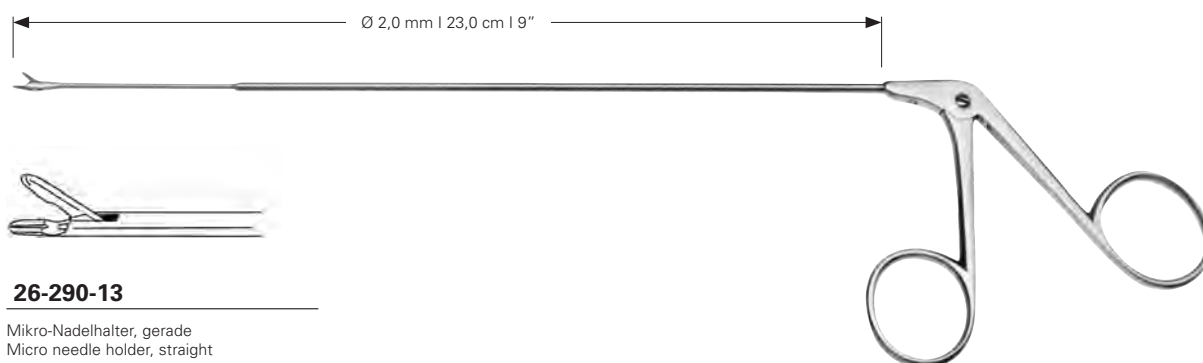
**26-290-07** Ø 2,0 mm

Mikro-Löffelzange, aufgebogen  
Micro cup-shaped forceps, curved upwards  
Micro-pinza en forma de cucharilla, curva hacia arriba  
Micropinze a cucchiaio, curvo verso l'alto



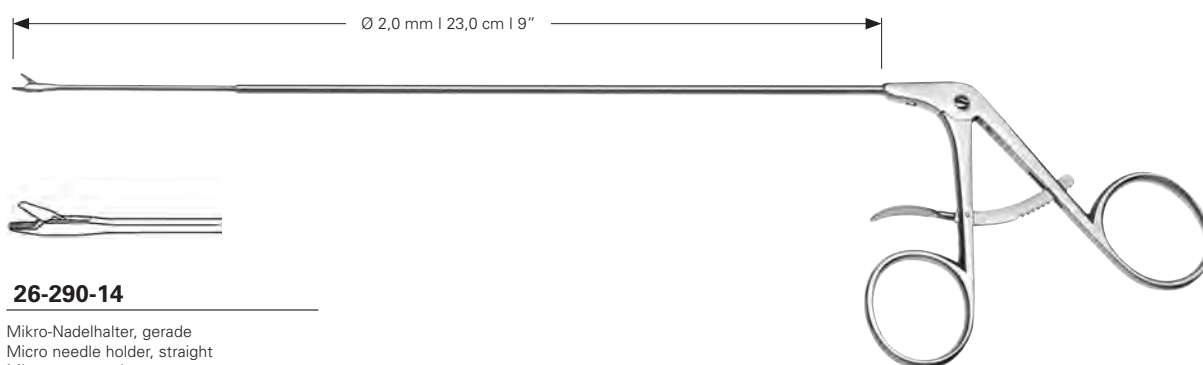
**26-290-11**

Mikro-Schere, aufgebogen  
Micro scissors, curved upwards  
Micro-tijeras de agarre, curva hacia arriba  
Microforbici da presa, curvo verso l'alto



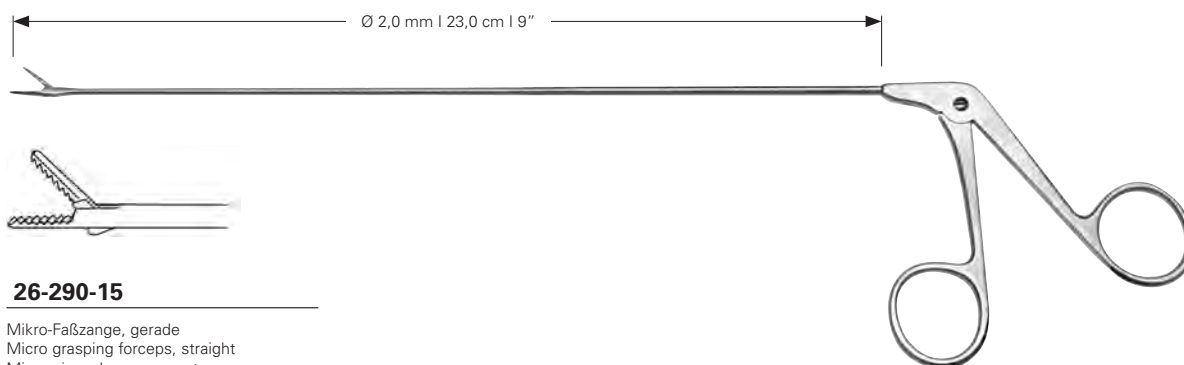
**26-290-13**

Mikro-Nadelhalter, gerade  
Micro needle holder, straight  
Micro-porta-aguja, recta  
Microportaghi, retto



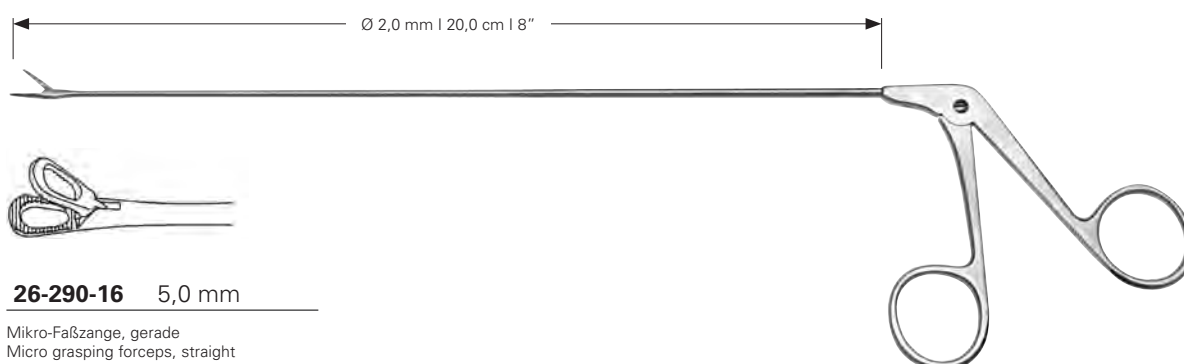
**26-290-14**

Mikro-Nadelhalter, gerade  
Micro needle holder, straight  
Micro-porta-aguja, recta  
Microportaghi, retto



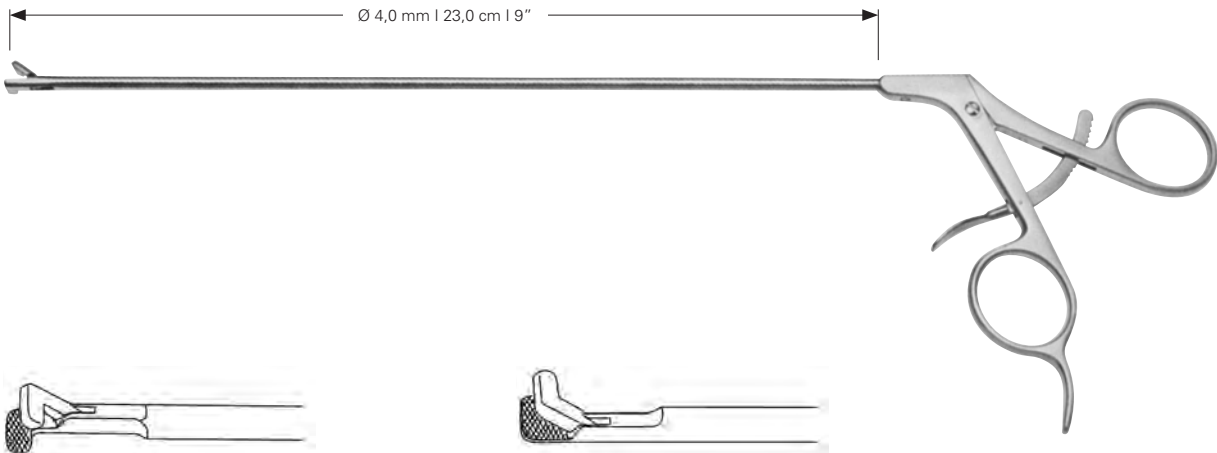
**26-290-15**

Mikro-Faßzange, gerade  
Micro grasping forceps, straight  
Micro-pinza de agarre, recta  
Micropinze da presa, retto



**26-290-16** 5,0 mm

Mikro-Faßzange, gerade  
Micro grasping forceps, straight  
Micro-pinza de agarre, recta  
Micropinze da presa, retto

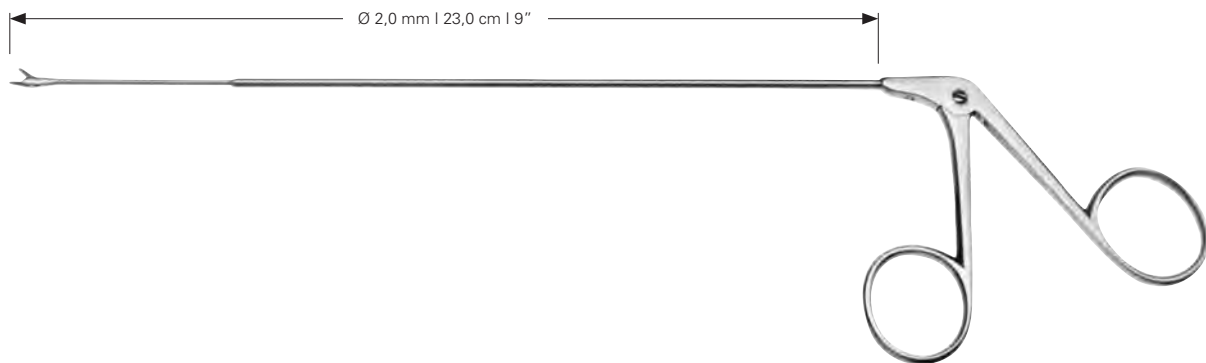


**26-290-17** 90°

Mikro-Nadelhalter, links gebogen  
Micro needle holder, curved left  
Micro-porta-aguja, curva a la izquierda  
Microportaghi, curvo verso sinistra

**26-290-18** 90°

Mikro-Nadelhalter, rechts gebogen  
Micro needle holder, curved right  
Micro-porta-aguja, curva a la derecha  
Microportaghi, curvo verso destra



**26-290-20**

Mikro-Schere, gerade  
Micro scissors, straight  
Micro-tijeras de agarre, recta  
Microforbici da presa, retto

**26-290-21** 15°

**26-290-22** 45°  
Mikro-Schere, aufgebogen  
Micro scissors, curved upwards  
Micro-tijeras de agarre, curva hacia arriba  
Microforbici da presa, curvo verso l'alto

**26-290-23**

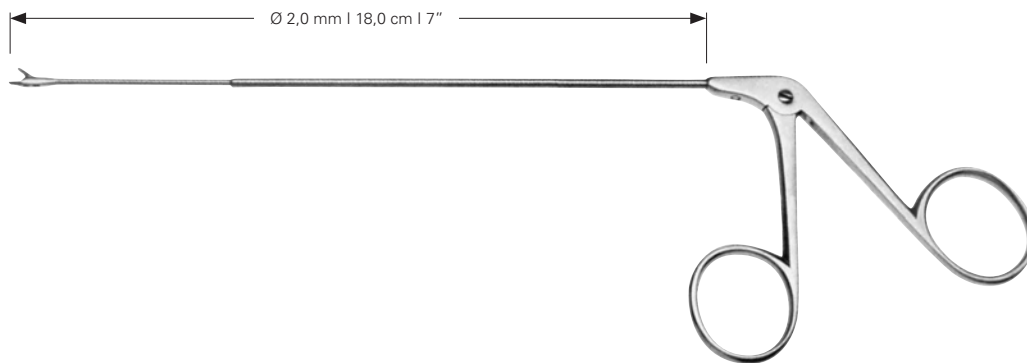
Mikro-Schere, links gebogen  
Micro scissors, curved left  
Micro-tijeras de agarre, curva a la izquierda  
Microforbici da presa, curvo verso sinistra

**26-290-24**

Mikro-Schere, rechts gebogen  
Micro scissors, curved right  
Micro-tijeras de agarre, curva a la derecha  
Microforbici da presa, curvo verso destra

**26-290-25**

Mikro-Schere, gerade, horizontal öffnend  
Micro scissors, straight, horizontal opening  
Micro-tijeras de agarre, recta, abertura horizontal  
Microforbici da presa, retto, apertura orizzontale



**26-290-26**

Mikro-Schere, gerade  
 Micro scissors, straight  
 Micro-tijeras de agarre, recta  
 Microforbici da presa, retto



**26-290-27** 45°

Mikro-Schere, aufgebogen  
 Micro scissors, curved upwards  
 Micro-tijeras de agarre, curva hacia arriba  
 Microforbici da presa, curvo verso l'alto



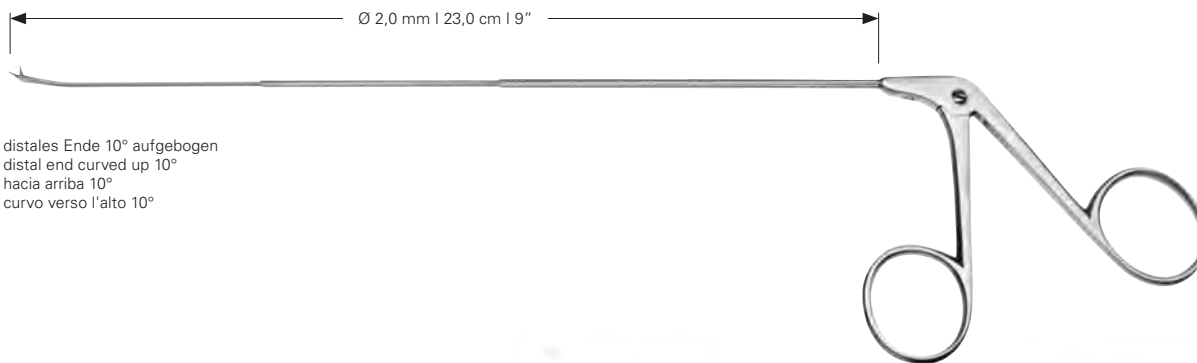
**26-290-34**

Mikro-Schere, links gebogen  
 Micro scissors, curved left  
 Micro-tijeras de agarre, curva a la izquierda  
 Microforbici da presa, curvo verso sinistra



**26-290-35**

Mikro-Schere, rechts gebogen  
 Micro scissors, curved right  
 Micro-tijeras de agarre, curva a la derecha  
 Microforbici da presa, curvo verso destra



distales Ende 10° aufgebogen  
 distal end curved up 10°  
 hacia arriba 10°  
 curvo verso l'alto 10°



**26-290-30**

Mikro-Schere, gerade  
 Micro scissors, straight  
 Micro-tijeras de agarre, recta  
 Microforbici da presa, retto



**26-290-31** 45°

Mikro-Schere, aufgebogen  
 Micro scissors, curved upwards  
 Micro-tijeras de agarre, curva hacia arriba  
 Microforbici da presa, curvo verso l'alto



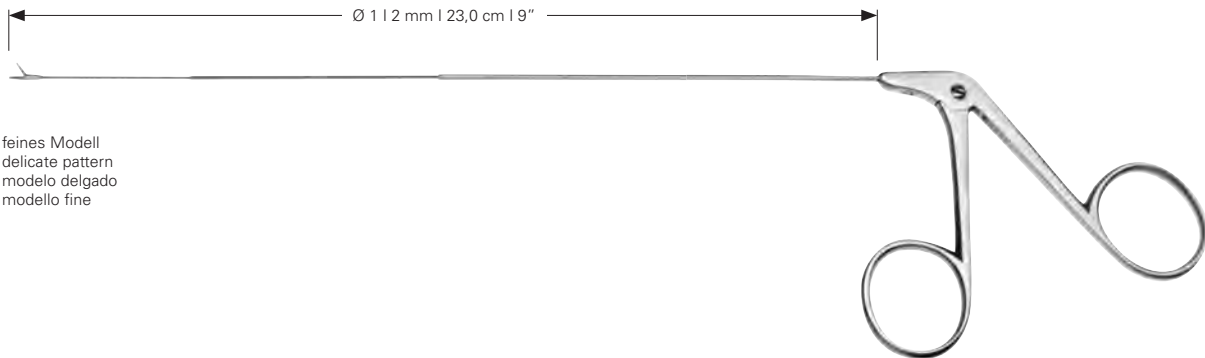
**26-290-32**

Mikro-Schere, links gebogen  
 Micro scissors, curved left  
 Micro-tijeras de agarre, curva a la izquierda  
 Microforbici da presa, curvo verso sinistra



**26-290-33**

Mikro-Schere, rechts gebogen  
 Micro scissors, curved right  
 Micro-tijeras de agarre, curva a la derecha  
 Microforbici da presa, curvo verso destra



feines Modell  
delicate pattern  
modelo delgado  
modello fine



**26-290-40**

Mikro-Schere, gerade  
Micro scissors, straight  
Micro-tijeras de agarre, recta  
Microforbici da presa, retto



**26-290-41 45°**

Mikro-Schere, aufgebogen  
Micro scissors, curved upwards  
Micro-tijeras de agarre, curva hacia arriba  
Microforbici da presa, curvo verso l'alto



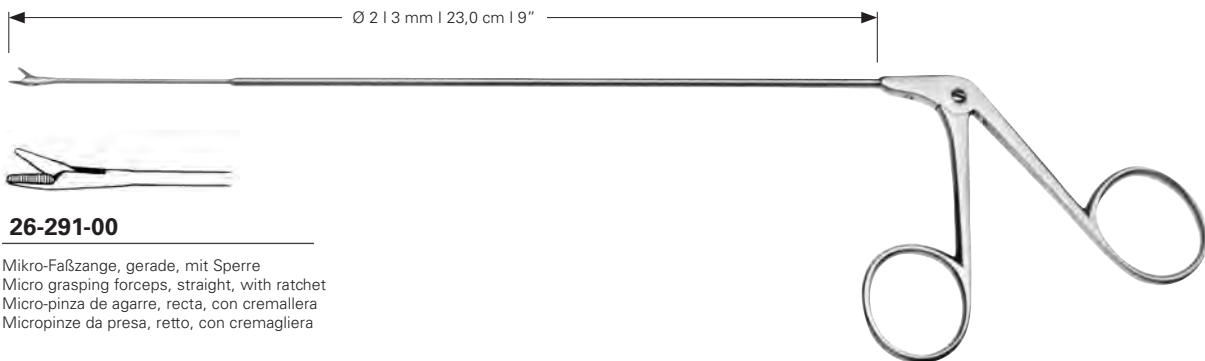
**26-290-42**

Mikro-Schere, links gebogen  
Micro scissors, curved left  
Micro-tijeras de agarre, curva a la izquierda  
Microforbici da presa, curvo verso sinistra



**26-290-43**

Mikro-Schere, rechts gebogen  
Micro scissors, curved right  
Micro-tijeras de agarre, curva a la derecha  
Microforbici da presa, curvo verso destra



**26-291-00**

Mikro-Faßzange, gerade, mit Sperre  
Micro grasping forceps, straight, with ratchet  
Micro-pinza de agarre, recta, con cremallera  
Micropinze da presa, retto, con cremagliera



**26-291-01**

Mikro-Faßzange, gerade  
Micro grasping forceps, straight  
Micro-pinza de agarre, recta  
Micropinze da presa, retto



**26-291-02**

Mikro-Faßzange, links gebogen  
Micro grasping forceps, curved left  
Micro-pinza de agarre, curva a la izquierda  
Micropinze da presa, curvo verso sinistra



**26-291-03**

Mikro-Faßzange, rechts gebogen  
Micro grasping forceps, curved right  
Micro-pinza de agarre, curva a la derecha  
Micropinze da presa, curvo verso destra



**26-291-11**

Mikro-Faßzange, aufgebogen  
Micro grasping forceps, curved upwards  
Micro-pinza de agarre, curva hacia arriba  
Micropinze da presa, curvo verso l'alto



**26-291-12**

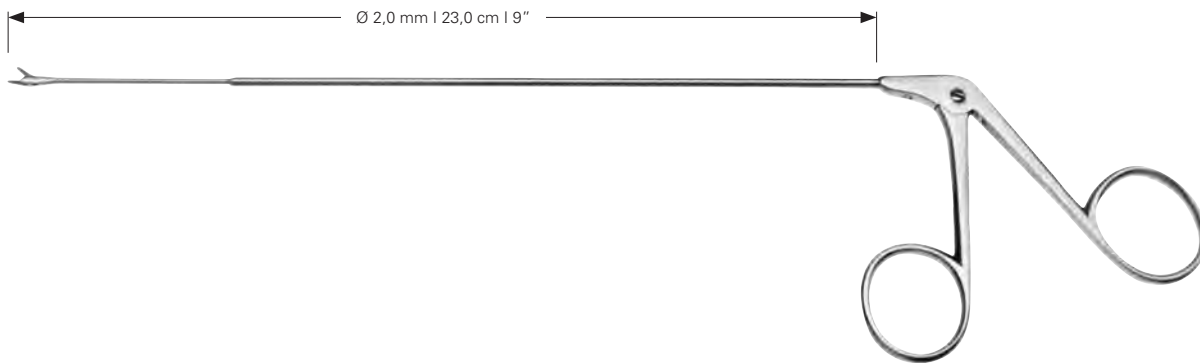
Mikro-Faßzange, links aufgebogen  
Micro grasping forceps, curved up left  
Micro-pinza de agarre, hacia arriba izquierda  
Micropinze da presa, curve verso l'alto sinistra



**26-291-13**

Mikro-Faßzange, rechts aufgebogen  
Micro grasping forceps, curved up right  
Micro-pinza de agarre, hacia arriba derecha  
Micropinze da presa, curve verso l'alto destra





**26-291-20** Ø 2,0 mm

Mikro-Löffelzange, gerade  
 Micro cup-shaped forceps, straight  
 Micro-pinza en forma de cucharilla, recta  
 Micropinze a cucchiaio, retto



**26-291-21** Ø 2,0 mm

Mikro-Löffelzange, aufgebogen  
 Micro cup-shaped forceps, curved upwards  
 Micro-pinza en forma de cucharilla, curva hacia arriba  
 Micropinze a cucchiaio, curvo verso l'alto



**26-291-22** Ø 2,0 mm

Mikro-Löffelzange, links gebogen  
 Micro cup-shaped forceps, curved left  
 Micro-pinza en forma de cucharilla, curva a la izquierda  
 Micropinze a cucchiaio, curvo verso sinistra



**26-291-23** Ø 2,0 mm

Mikro-Löffelzange, rechts gebogen  
 Micro cup-shaped forceps, curved right  
 Micro-pinza en forma de cucharilla, curva a la derecha  
 Micropinze a cucchiaio, curvo verso destra



**26-291-32** Ø 2,0 mm

Mikro-Löffelzange, links aufgebogen  
 Micro cup-shaped forceps, curved up left  
 Micro-pinza en forma de cucharilla, hacia arriba izquierda  
 Micropinze a cucchiaio, curve verso l'alto sinistra



**26-291-33** Ø 2,0 mm

Mikro-Löffelzange, rechts aufgebogen  
 Micro cup-shaped forceps, curved up right  
 Micro-pinza en forma de cucharilla, hacia arriba derecha  
 Micropinze a cucchiaio, curve verso l'alto destra



**26-291-34** 2,0 x 2,0 mm

Mikro-Löffelzange, links aufgebogen  
 Micro cup-shaped forceps, curved up left  
 Micro-pinza en forma de cucharilla, hacia arriba izquierda  
 Micropinze a cucchiaio, curve verso l'alto sinistra



**26-291-35** 2,0 x 2,0 mm

Mikro-Löffelzange, rechts aufgebogen  
 Micro cup-shaped forceps, curved up right  
 Micro-pinza en forma de cucharilla, hacia arriba derecha  
 Micropinze a cucchiaio, curve verso l'alto destra



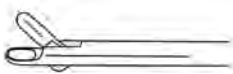
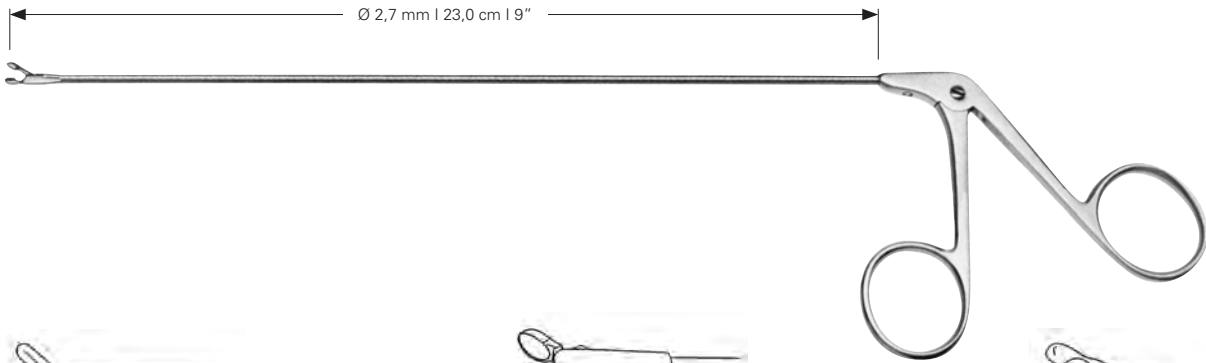
**26-291-42** Ø 2,0 mm

Mikro-Löffelzange, horizontal, links  
 Micro cup-shaped forceps, horizontal, left  
 Micro-pinza en forma de cucharilla, horizontal, izquierda  
 Micropinze a cucchiaio, orizzontale, sinistra



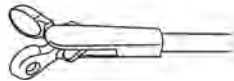
**26-291-43** Ø 2,0 mm

Mikro-Löffelzange, horizontal, rechts  
 Micro cup-shaped forceps, horizontal, right  
 Micro-pinza en forma de cucharilla, horizontal, derecha  
 Micropinze a cucchiaio, orizzontale, destra



**26-291-44** 3,0 x 4,0 mm

Mikro-Löffelzange, gerade, kräftiges Modell  
Micro cup-shaped forceps, straight, heavy pattern  
Micro-pinza en forma de cucharilla, recta, modelo fornido  
Micropinze a cucchiaio, retto, modello forte



**26-291-45** Ø 4,0 mm

Mikro-Löffelzange, gerade  
Micro cup-shaped forceps, straight  
Micro-pinza en forma de cucharilla, recta  
Micropinze a cucchiaio, retto



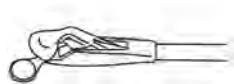
**26-291-50** Ø 4,0 mm

Mikro-Löffelzange, gerade  
Micro cup-shaped forceps, straight  
Micro-pinza en forma de cucharilla, recta  
Micropinze a cucchiaio, retto



**26-291-51** Ø 4,0 mm

Mikro-Löffelzange, aufgebogen  
Micro cup-shaped forceps, curved upwards  
Micro-pinza en forma de cucharilla, curva hacia arriba  
Micropinze a cucchiaio, curvo verso l'alto



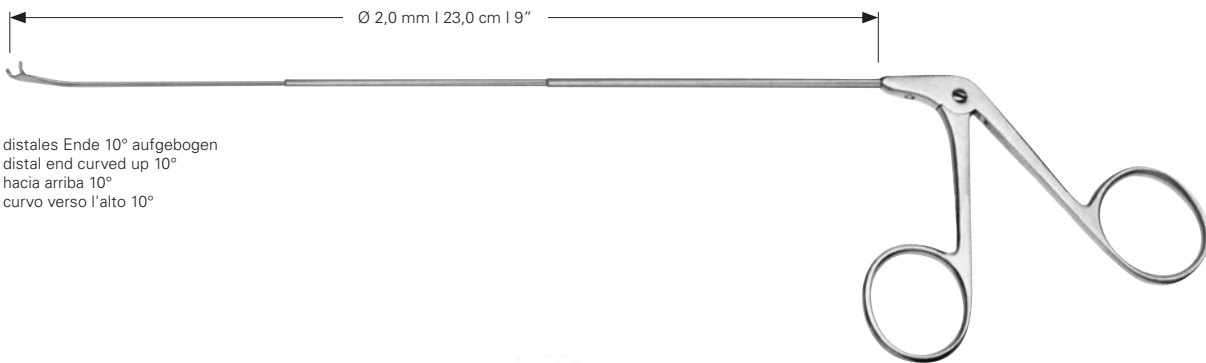
**26-291-52** Ø 4,0 mm

Mikro-Löffelzange, links aufgebogen  
Micro cup-shaped forceps, curved up left  
Micro-pinza en forma de cucharilla, curva hacia izquierda  
Micropinze a cucchiaio, curvo verso l'alto sinistra



**26-291-53** Ø 4,0 mm

Mikro-Löffelzange, rechts gebogen  
Micro cup-shaped forceps, curved right  
Micro-pinza en forma de cucharilla, curva a la derecha  
Micropinze a cucchiaio, curvo verso destra



distales Ende 10° aufgebogen  
distal end curved up 10°  
hacia arriba 10°  
curvo verso l'alto 10°



**26-291-60** Ø 2,0 mm

Mikro-Löffelzange, gerade  
Micro cup-shaped forceps, straight  
Micro-pinza en forma de cucharilla, recta  
Micropinze a cucchiaio, retto



**26-291-61** Ø 2,0 mm

Mikro-Löffelzange, aufgebogen  
Micro cup-shaped forceps, curved upwards  
Micro-pinza en forma de cucharilla, curva hacia arriba  
Micropinze a cucchiaio, curvo verso l'alto



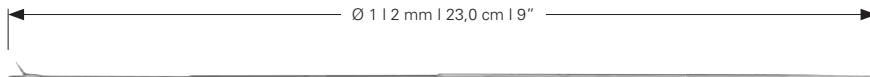
**26-291-62** Ø 2,0 mm

Mikro-Löffelzange, links gebogen  
Micro cup-shaped forceps, curved left  
Micro-pinza en forma de cucharilla, curva a la izquierda  
Micropinze a cucchiaio, curvo verso sinistra



**26-291-63** Ø 2,0 mm

Mikro-Löffelzange, rechts gebogen  
Micro cup-shaped forceps, curved right  
Micro-pinza en forma de cucharilla, curva a la derecha  
Micropinze a cucchiaio, curvo verso destra



feines Modell  
 delicate pattern  
 modelo delgado  
 modello fine



**26-292-01**

Mikro-Faßzange, gerade  
 Micro grasping forceps, straight  
 Micro-pinza de agarre, recta  
 Micropinze da presa, retto



**26-292-02**

Mikro-Faßzange, links gebogen  
 Micro grasping forceps, curved left  
 Micro-pinza de agarre, curva a la izquierda  
 Micropinze da presa, curvo verso sinistra



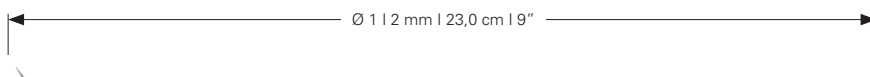
**26-292-03**

Mikro-Faßzange, rechts gebogen  
 Micro grasping forceps, curved right  
 Micro-pinza de agarre, curva a la derecha  
 Micropinze da presa, curvo verso destra



**26-292-11**

Mikro-Faßzange, aufgebogen  
 Micro grasping forceps, curved upwards  
 Micro-pinza de agarre, curva hacia arriba  
 Micropinze da presa, curvo verso l'alto



feines Modell  
 delicate pattern  
 modelo delgado  
 modello fine



**26-292-20** Ø 1,0 mm

Mikro-Löffelzange, gerade  
 Micro cup-shaped forceps, straight  
 Micro-pinza en forma de cucharilla, recta  
 Micropinze a cucchiaio, retto



**26-292-21** Ø 1,0 mm

Mikro-Löffelzange, aufgebogen  
 Micro cup-shaped forceps, curved upwards  
 Micro-pinza en forma de cucharilla, hacia arriba  
 Micropinze a cucchiaio, curvo verso l'alto



**26-292-22** Ø 1,0 mm

Mikro-Löffelzange, links gebogen  
 Micro cup-shaped forceps, curved left  
 Micro-pinza en forma de cucharilla, hacia la izquierda  
 Micropinze a cucchiaio, curvo verso sinistra



**26-292-23** Ø 1,0 mm

Mikro-Löffelzange, rechts gebogen  
 Micro cup-shaped forceps, curved right  
 Micro-pinza en forma de cucharilla, hacia a la derecha  
 Micropinze a cucchiaio, curvo verso destra



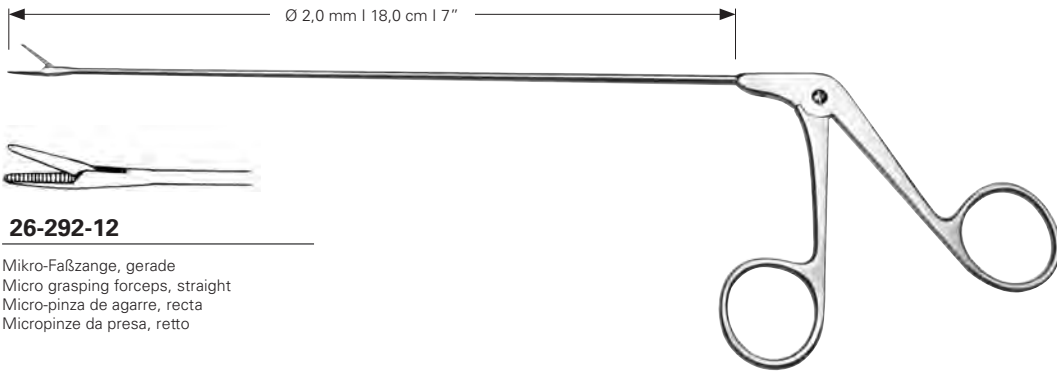
**26-292-32** Ø 1,0 mm

Mikro-Löffelzange, links aufgebogen  
 Micro cup-shaped forceps, curved up left  
 Micro-pinza en forma de cucharilla, hacia arriba izquierda  
 Micropinze a cucchiaio, curve verso l'alto sinistra



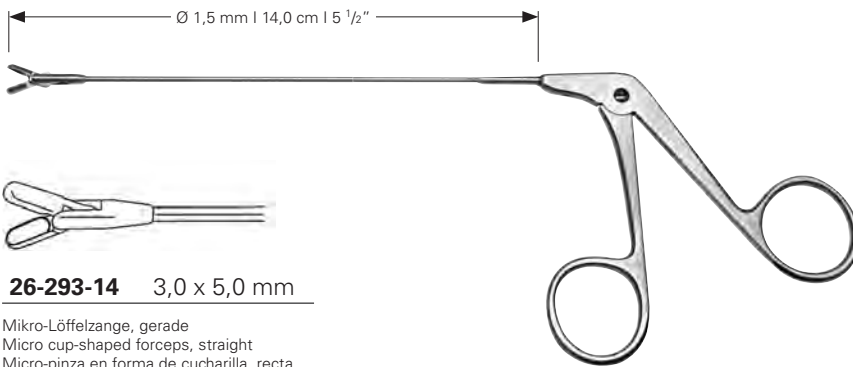
**26-292-33** Ø 1,0 mm

Mikro-Löffelzange, rechts aufgebogen  
 Micro cup-shaped forceps, curved up right  
 Micro-pinza en forma de cucharilla, hacia arriba derecha  
 Micropinze a cucchiaio, curve verso l'alto destra



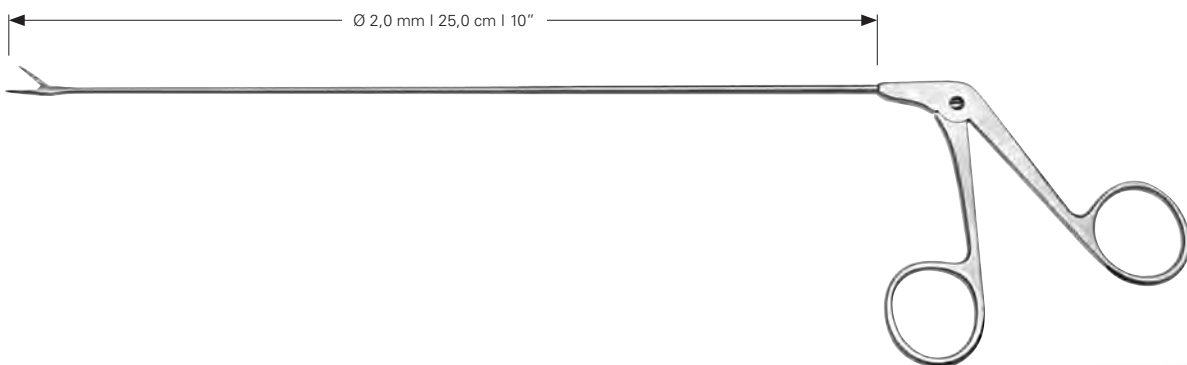
**26-292-12**

Mikro-Faßzange, gerade  
Micro grasping forceps, straight  
Micro-pinza de agarre, recta  
Micropinze da presa, retto



**26-293-14** 3,0 x 5,0 mm

Mikro-Löffelzange, gerade  
Micro cup-shaped forceps, straight  
Micro-pinza en forma de cucharilla, recta  
Micropinze a cucchiaio, retto



**26-294-01** 2,0 x 3,0 mm

Mikro-Löffelzange, gerade  
Micro cup-shaped forceps, straight  
Micro-pinza en forma de cucharilla, recta  
Micropinze a cucchiaio, retto



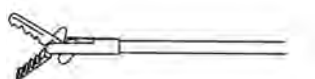
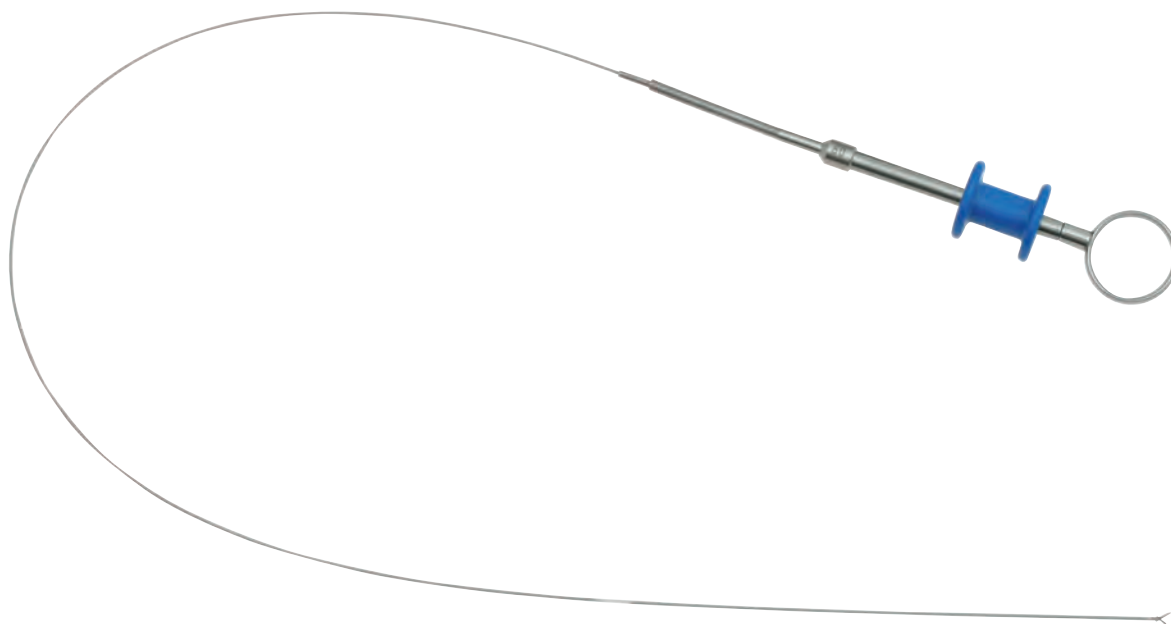
**26-294-02**

Mikro-Zange, oval, gerade  
Micro forceps, oval, straight  
Micro-pinza, ovale, recta  
Micropinze, ovale, retto



**26-294-03** 90°

Mikro-Stanze, gerade  
Micro punch, straight  
Micro-pinza, recta  
Micropinze, retto



**26-295-01** Ø 1,0 x 120 cm

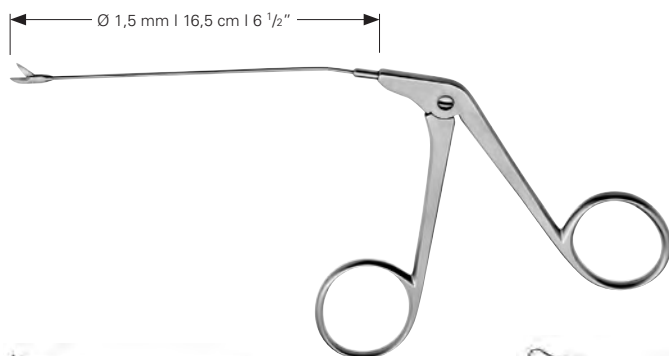
Mikro-Faßzange, gerade  
 Micro grasping forceps, straight  
 Micro-pinza de agarre, recta  
 Micropinze da presa, retto



**26-295-02** Ø 1,0 x 120 cm

Mikro-Löffelzange, gerade  
 Micro cup-shaped forceps, straight  
 Micro-pinza en forma de cucharilla, recta  
 Micropinze a cucchiaio, retto

Andere Modelle auf Anfrage  
 Other patterns on request  
 Otro modelo a consulta  
 Altri modelli su domanda



## FAHLBUSCH

**26-296-00**

Mikro-Schere, horizontal öffnend  
 Micro scissors, horizontal opening  
 Micro-tijeras de agarre, abertura horizontal  
 Microforbici da presa, apertura orizzontale



## NICOLA

**26-296-01** Ø 2,5 mm

Mikro-Löffelzange, gerade  
 Micro cup-shaped forceps, straight  
 Micro-pinza en forma de cucharilla, recta  
 Micropinze a cucchiaio, retto



## YASARGIL-NICOLA

**26-296-02**

Mikro-Faßzange, gerade  
 Micro grasping forceps, straight  
 Micro-pinza de agarre, recta  
 Micropinze da presa, retto



## NICOLA

**26-296-03**

Mikro-Schere, gerade  
 Micro scissors, straight  
 Micro-tijeras de agarre, recta  
 Microforbici da presa, retto



Laryngealschnürer  
Laryngeal snare  
Cierra-nudos para laringología  
Serranodi per laringologia

**26-297-05**



Verpackungseinheit: 12 St.  
Packing unit: 12 pieces  
Unidad: 12 piezas  
Confezione: 12 pezzi

Schnürdrähte  
Snare wires  
Alambre para amigdalótomo  
Filo per serranodi



**26-297-99** Ø 0,3 mm

Handgriff für Stabinstrumente  
Handle for Laryngeal instruments  
Mango para instrumentos laringeal  
Manico per strumenti laringeal

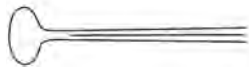


**26-298-00** 10,0 cm, 4"



**26-298-01** 24,0 cm, 9 1/2"

Sichelmesser  
Sickle knife  
Bisturí falciforme  
Bisturi a falce



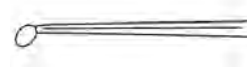
**26-298-02** 24,0 cm, 9 1/2"

Rundmesser  
Round edge knife  
Cuchillo redondo  
Bisturi circolare



**26-298-03** 24,0 cm, 9 1/2"

Rundmesser  
Round edge knife  
Cuchillo redondo  
Bisturi circolare



**26-298-04** 24,0 cm, 9 1/2"

Rundmesser, 45°  
Round edge knife, 45°  
Cuchillo redondo, 45°  
Bisturi circolare, 45°



**26-298-05** 24,0 cm, 9 1/2"

Larynxhaken, 90°  
Laryngeal hook, 90°  
Gancho laríngeo 90°  
Uncino per laringe 90°



**26-298-06** 24,0 cm, 9 1/2"

Larynxhaken, 30°  
Laryngeal hook, 30°  
Gancho laríngeo 30°  
Uncino per laringe 30°



**26-298-07** 24,0 cm, 9 1/2"

Larynxhaken  
Laryngeal hook  
Gancho laríngeo  
Uncino per laringe



**26-298-08** 24,0 cm, 9 1/2 "

Fadengabel  
 Ligature guide  
 Guía de la sutura  
 Guida del suturare



**26-298-09** 24,0 cm, 9 1/2 "

Knotenführer  
 Knot pusher  
 Empujador del nudo  
 Spingitoio del nodo



**26-298-10** 24,0 cm, 9 1/2 "

Saugraspatorium  
 Suction raspatory  
 Succión raspatory  
 Aspirazione raspatory



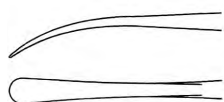
**26-298-11** 24,0 cm, 9 1/2 "

Umstechungsnadel rechts  
 Tonsil ligature needle, right  
 Aguja de la sutura de la amigdala, derecha  
 Ago del suturare della tonsilla, destra



**26-298-12** 24,0 cm, 9 1/2 "

Umstechungsnadel links  
 Tonsil ligature needle, left  
 Aguja de la sutura de la amigdala, izquierdo  
 Ago del suturare della tonsilla, sinistra



**26-298-13** 24,0 cm, 9 1/2 "

Elevatorium, stumpf  
 Elevator, blunt  
 Elevador, romo  
 Elevatore, smusso



**26-298-21** 24,0 cm, 9 1/2 "

Larynxmesser  
 Laryngeal knife  
 Bisturi laringeo  
 Bisturi per laringe



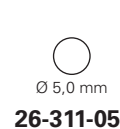
**26-298-22** 24,0 cm, 9 1/2 "

Larynxmesser  
 Laryngeal knife  
 Bisturi laringeo  
 Bisturi per laringe

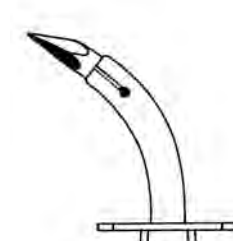


**26-298-23** 28,0 cm, 11 "

Watteträger  
 Cotton applicator  
 Porta-algodones  
 Portacotone



Intubationsrohr  
 Intubation tube  
 Tubo del intubation  
 Tubo di intubazione



Tracheal Trokar  
 Tracheotomy trocar  
 Traqueótomo  
 Trequarto per tracheotomia

## MOSHER-BRUENINGS

**26-311-05 - 26-311-09** 20,0 cm, 8 "

## UCKERMANN

**26-313-75 - 26-313-90** 13,0 cm, 5 1/8 "

Trachealdilatator  
 Tracheal dilator  
 Dilatatore traqueales  
 Dilatatori per tracheotomia



**TROUSSEAU**

**26-315-12** 14,0 cm, 5 1/2"

Trachealdilatator  
 Tracheal dilator  
 Dilatatore traqueales  
 Dilatatori per tracheotomia



**LABORDE**

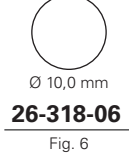
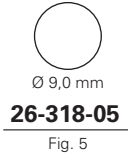
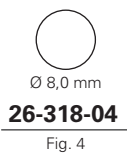
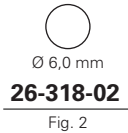
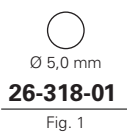
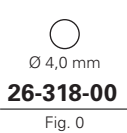
**26-317-12** 12,5 cm, 5"

Trachealdilatator  
 Tracheal dilator  
 Dilatatore traqueales  
 Dilatatori per tracheotomia



**LABORDE**

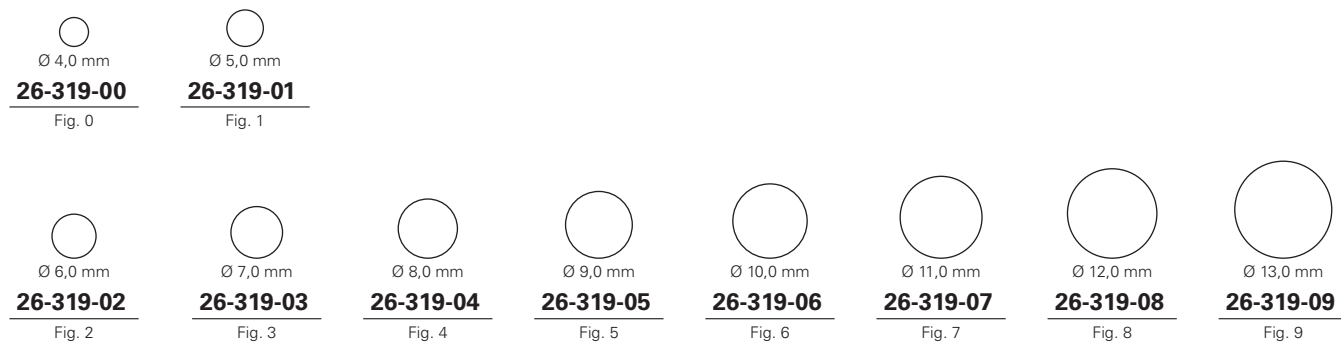
**26-317-13** 14,0 cm, 5 1/2"



**LUER**

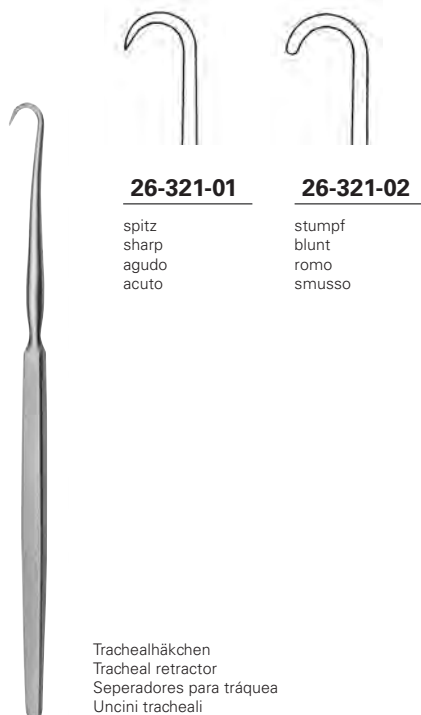
**26-318-00 - 26-318-10**





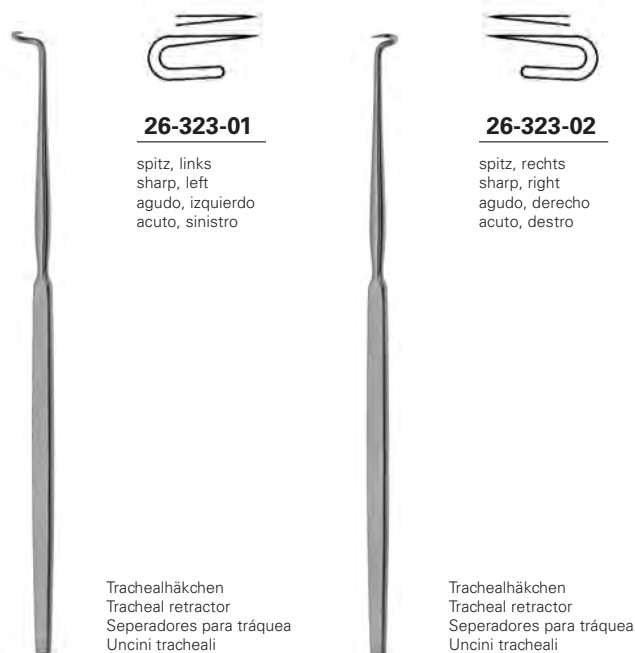
## CHEVALIER-JACKSON

26-319-00 - 26-319-09



## ITERSON

26-321-01 - 26-321-02 16,0 cm, 6 ¼"



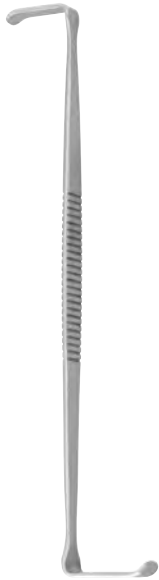
## BOSE

26-323-01 16,5 cm, 6 ½"

## BOSE

26-323-02 16,5 cm, 6 ½"

Trachealhäkchen  
Tracheal retractor  
Seperadores para tráquea  
Uncini tracheali



**HOUSE**

**26-325-15** 15,0 cm, 6 "

Trachealhäkchen  
Tracheal retractor  
Seperadores para tráquea  
Uncini tracheali



**JACKSON**

**26-329-15** 15,0 cm, 6 "

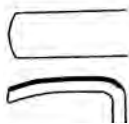


**26-331-15**

Trachealhäkchen  
Tracheal retractor  
Seperadores para tráquea  
Uncini tracheali

**NEWS**

**26-331-15** 15,0 cm, 6 "



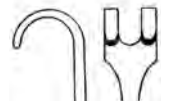
**26-333-17**



Trachealhäkchen  
Tracheal retractor  
Seperadores para tráquea  
Uncini tracheali

**LUKENS**

**26-333-17** 17,0 cm, 6 3/4 "



8 x 7 mm

**26-335-17**

15 x 11 mm



Trachealhäkchen  
Tracheal retractor  
Seperadores para tráquea  
Uncini tracheali

**JACKSON**

**26-335-17** 17,0 cm, 6 3/4 "



6 x 13 mm

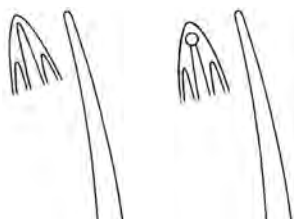
**26-337-21**



Trachealhäkchen  
Tracheal retractor  
Seperadores para tráquea  
Uncini tracheali

**SCHOENBORN**

**26-337-21** 20,5 cm, 8 "



**26-339-01**

**26-339-02**

mit Loch  
with hole  
con el agujero  
con il foro



Kropfsonden  
Goitre probes  
Sonda para bocio  
Sonda per gozzo

**KOCHER**

**26-339-01 - 26-339-02** 15,0 cm, 6 "



**26-339-03**

mit Loch  
with hole  
con el agujero  
con il foro



Kropfsonden  
Goitre probes  
Sonda para bocio  
Sonda per gozzo

**KOCHER**

**26-339-03** 18,0 cm, 7 "



**26-340-15**  
**26-340-20**

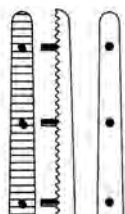
Kropffasszange  
Goitre grasping forceps  
Pinze de sugestión para bocio  
Pinza da presa per gozzo



**LAHEY**

**26-340-15** 15,0 cm, 6 "

**26-340-20** 20,0 cm, 8 "



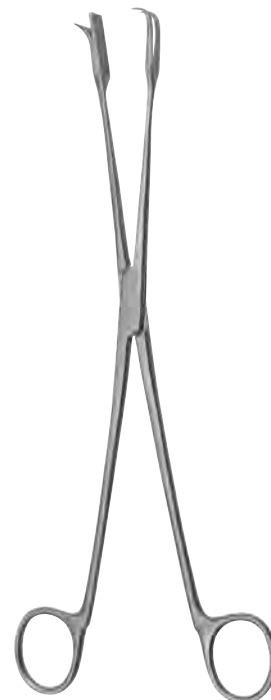
**26-341-17**

Muskelklemme  
Muscular clamp  
Pinza-clamp para músculos  
Pinza muscolare



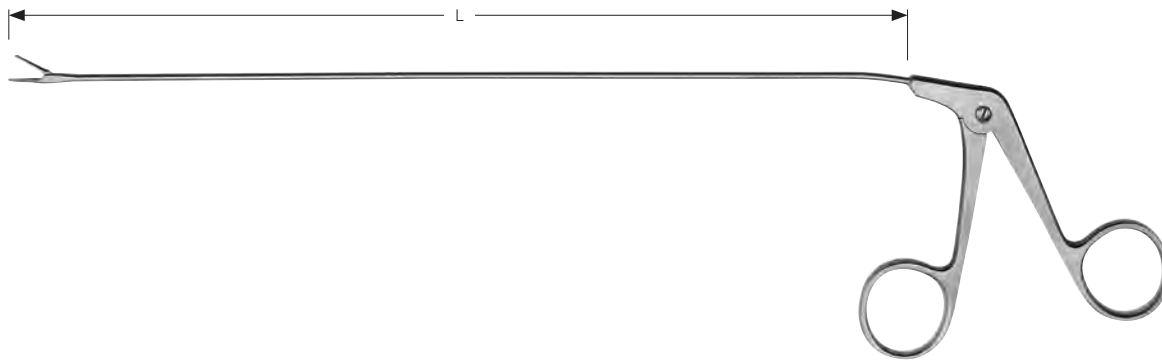
**MASTIN**

**26-341-17** 17,0 cm, 6 3/4 "



**FACE-LIFT**

**26-345-18** 18,0 cm, 7 "



**26-400-25** 25,0 cm, 9 3/4 "  
**26-400-35** 35,0 cm, 13 3/4 "  
**26-400-50** 50,0 cm, 20 "

Alligatorfaßzange, gerade  
Alligator grasping forceps, straight  
Pinza de agarre cocodrilo, recta  
Pinza alligatore, retto



**26-401-25** 25,0 cm, 9 3/4 "  
**26-401-35** 35,0 cm, 13 3/4 "  
**26-401-50** 50,0 cm, 20 "

Faßzange, gerade  
Grasping forceps, straight  
Pinza de agarre, recta  
Pinze da presa, retto

Ø 3,0 mm



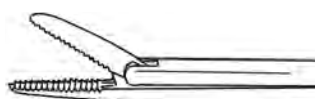
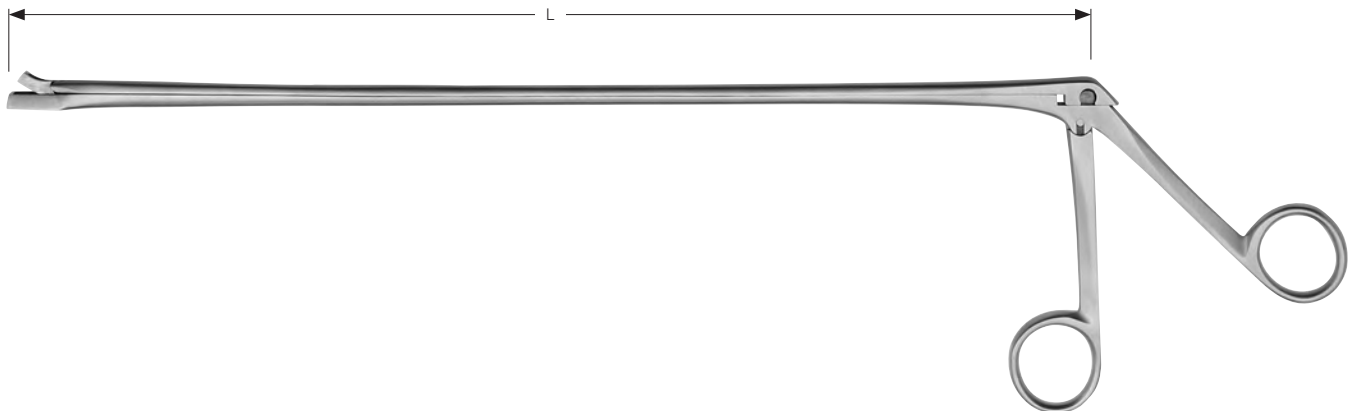
**26-402-25** 25,0 cm, 9 3/4 "  
**26-402-35** 35,0 cm, 13 3/4 "  
**26-402-50** 50,0 cm, 20 "

Löffelzange, gerade  
Cup-shaped forceps, straight  
Pinza en forma de cucharilla, recta  
Pinze a cucchiaio, retto



**26-403-25** 25,0 cm, 9 3/4 "  
**26-403-35** 35,0 cm, 13 3/4 "  
**26-403-50** 50,0 cm, 20 "

Probeexzisionszange, gerade  
Biopsy forceps, straight  
Pinza para biopsia excisional, recta  
Pinza di escissione di prova retto



**26-417-35** 35,0 cm, 13 3/4 "  
**26-417-50** 50,0 cm, 20 "

Faßzange, gerade  
Grasping forceps, straight  
Pinza de agarre, recta  
Pinze da presa, retto



**26-418-35** 35,0 cm, 13 3/4 "  
**26-418-50** 50,0 cm, 20 "

Alligatorfaßzange, gerade  
Alligator grasping forceps, straight  
Pinza de agarre cocodrilo, recta  
Pinza alligatore, retto

Ø 6,0 mm



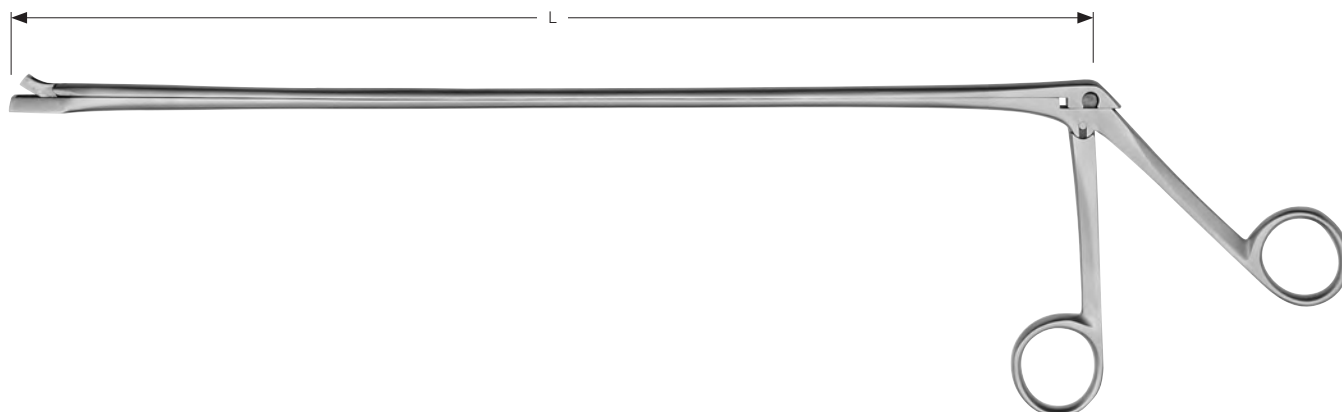
**26-419-35** 35,0 cm, 13 3/4 "  
**26-419-50** 50,0 cm, 20 "

Biopsiestanze, gerade  
Biopsy punch, straight  
Pinza para biopsia, recta  
Pinza per biopsia, retto



**26-420-35** 35,0 cm, 13 3/4 "  
**26-420-50** 50,0 cm, 20 "

Löffelzange, gerade  
Cup-shaped forceps, straight  
Pinza en forma de cucharilla, recta  
Pinze a cucchiaio, retto



<b>26-410-30</b>	30,0 cm, 12 "
<b>26-410-40</b>	40,0 cm, 16 "
<b>26-410-50</b>	50,0 cm, 20 "
<b>26-410-60</b>	60,0 cm, 24 "

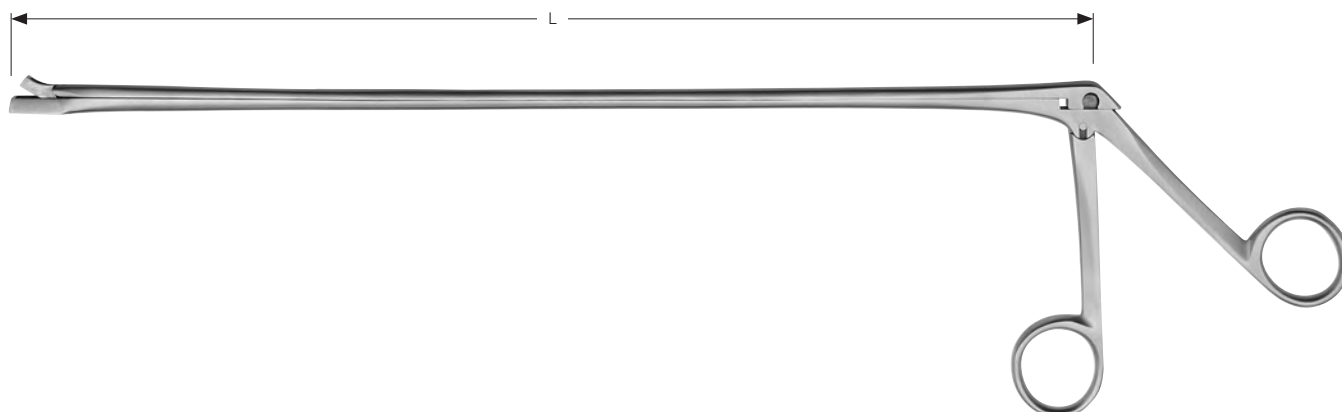
Probeexzisionszange, gerade  
Biopsy forceps, straight  
Pinza para biopsia excisional, recta  
Pinza di escissione di prova retto

<b>26-411-30</b>	30,0 cm, 12 "
<b>26-411-40</b>	40,0 cm, 16 "
<b>26-411-50</b>	50,0 cm, 20 "
<b>26-411-60</b>	60,0 cm, 24 "

Faßzange, gerade  
Grasping forceps, straight  
Pinza de agarre, recta  
Pinze da presa, retto

<b>26-412-30</b>	30,0 cm, 12 "
<b>26-412-40</b>	40,0 cm, 16 "
<b>26-412-50</b>	50,0 cm, 20 "
<b>26-412-60</b>	60,0 cm, 24 "

Alligatorfaßzange, gerade  
Alligator grasping forceps, straight  
Pinza de agarre cocodrilo, recta  
Pinza alligatore, retto



Ø 4,0 mm



<b>26-413-30</b>	30,0 cm, 12 "
<b>26-413-40</b>	40,0 cm, 16 "
<b>26-413-50</b>	50,0 cm, 20 "
<b>26-413-60</b>	60,0 cm, 24 "

Löffelzange, gerade  
Cup-shaped forceps, straight  
Pinza en forma de cucharilla, recta  
Pinze a cucchiaio, retto

<b>26-414-30</b>	30,0 cm, 12 "
<b>26-414-40</b>	40,0 cm, 16 "
<b>26-414-50</b>	50,0 cm, 20 "
<b>26-414-60</b>	60,0 cm, 24 "

Probeexzisionszange, gerade  
Biopsy forceps, straight  
Pinza para biopsia excisional, recta  
Pinza di escissione di prova retto

<b>26-415-30</b>	30,0 cm, 12 "
<b>26-415-40</b>	40,0 cm, 16 "
<b>26-415-50</b>	50,0 cm, 20 "
<b>26-415-60</b>	60,0 cm, 24 "

Löffelzange, gerade  
Cup-shaped forceps, straight  
Pinza en forma de cucharilla, recta  
Pinze a cucchiaio, retto

<b>26-416-30</b>	30,0 cm, 12 "
<b>26-416-40</b>	40,0 cm, 16 "
<b>26-416-50</b>	50,0 cm, 20 "
<b>26-416-60</b>	60,0 cm, 24 "

Löffelzange, aufgebogen  
Cup-shaped forceps, curved upwards  
Pinza en forma de cucharilla, curva hacia arriba  
Pinze a cucchiaio, curvo verso l'alto



Fig. 1

**26-500-08**



Fig. 2

**26-500-09**



Fig. 3

**26-500-12**

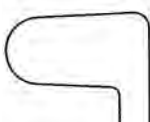


Fig. 4

**26-500-15**



Fig. 5

**26-500-16**



Fig. 6

**26-500-18**

selbsthaltend  
self-retaining  
autostático  
autostatico



Fig. 7

**26-500-19**

### THUDICHUM

**26-500-08 - 26-500-19** 6,5 cm, 2 ½ "

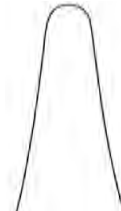


Fig. 1

**26-504-01**

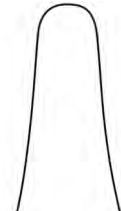


Fig. 2

**26-504-02**

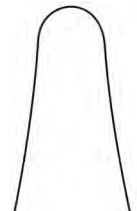


Fig. 3

**26-504-03**



selbsthaltend, Spreizung durch Stellschraube einstellbar  
self-retaining, spread adjustable by set screw  
autostático, abertura regulable mediante tornillo de ajuste  
autostatico, apertura regolabile mediante vite

### VOLTOLINI

**26-504-01 - 26-504-03**



Fig. 1

**26-506-01**

für Säuglinge  
for infants  
para lactantes  
per neonati



Fig. 2

**26-506-02**

für Kleinkinder  
for babies  
para niños  
per bambini



mit aseptischem Verschluss (zerlegbar)  
with aseptic joint (dismantable)  
con articulación aséptica (desmontable)  
con articolazione asettica (smontabile)

### TIECK-HALLE

**26-506-01 - 26-506-02** 13,5 cm, 5 ¼ "



Fig. 2

**26-506-22**

für Kleinkinder  
for babies  
para niños  
per bambini



mit aseptischem Verschluss (zerlegbar)  
with aseptic joint (dismantable)  
con articulación aséptica (desmontable)  
con articolazione asettica (smontabile)

### TIECK-HALLE

**26-506-22** 13,5 cm, 5 ¼ "

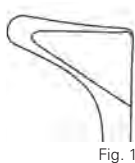


Fig. 1

**26-507-01**



Fig. 2

**26-507-02**

für Säuglinge  
for infants  
para lactantes  
per neonati

für Kleinkinder  
for babies  
para niños  
per bambini



mit Schraubschluß  
with screw joint  
con articulación de tornillo  
con articolazione a vite



Fig. 1

**26-508-01**

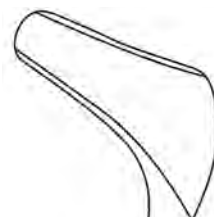


Fig. 2

**26-508-02**

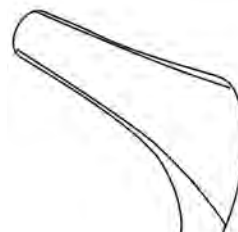


Fig. 3

**26-508-03**



mit aseptischem Verschuß (zerlegbar)  
with aseptic joint (dismantable)  
con articulación aseptica (desmontable)  
con articolazione aseptica (smontabile)

## TIECK-HALLE

**26-507-01 - 26-507-02** 13,5 cm, 5 ¼ "

## HARTMANN-HALLE

**26-508-01 - 26-508-03** 15,5 cm, 6 ⅛ "



Fig. 1

**26-509-01**



Fig. 2

**26-509-02**

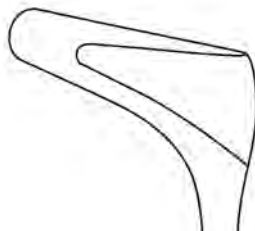


Fig. 3

**26-509-03**



mit Schraubschluß  
with screw joint  
con articulación de tornillo  
con articolazione a vite



Fig. 1

**26-513-01**

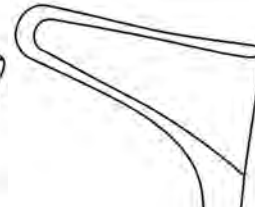


Fig. 2

**26-513-02**

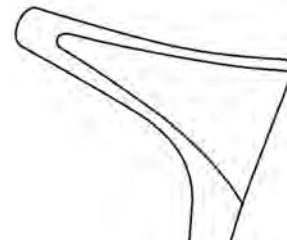


Fig. 3

**26-513-03**



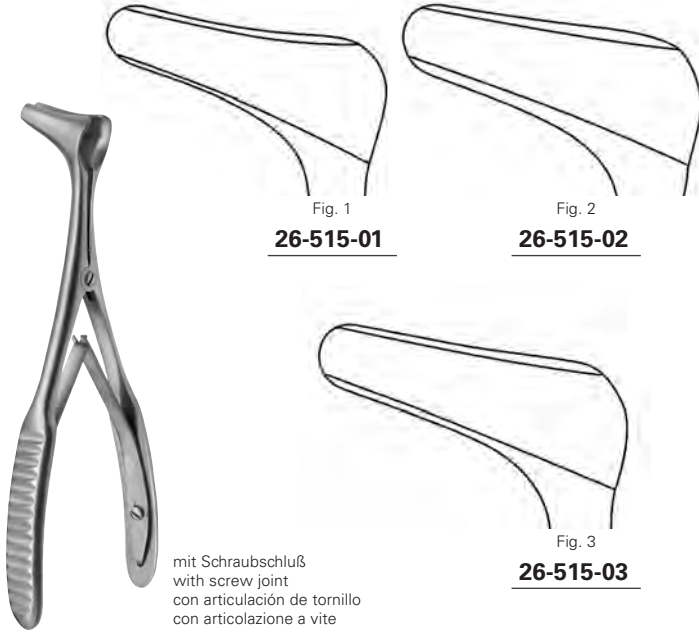
mit Schraubschluß  
with screw joint  
con articulación de tornillo  
con articolazione a vite

## HARTMANN-HALLE

**26-509-01 - 26-509-03** 15,5 cm, 6 ⅛ "

## HARTMANN

**26-513-01 - 26-513-03** 16,0 cm, 6 ¼ "



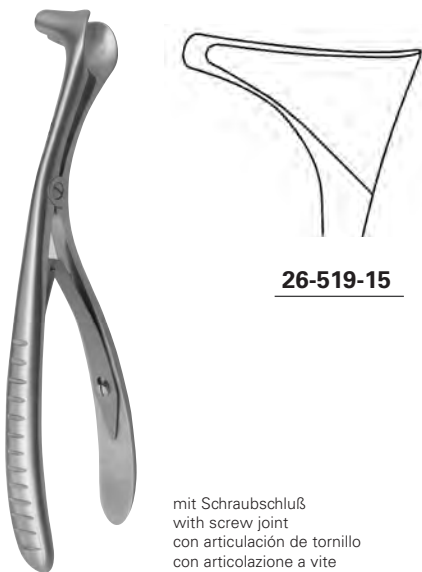
**MOD. WIEN**

**26-515-01 - 26-515-03** 14,0 cm, 5 ½"



**BECKMANN**

**26-519-14** 14,0 cm, 5 ½"



**BECKMANN**

**26-519-15** 15,0 cm, 6"



**HARTMANN**

**26-521-14** 14,5 cm, 5 ¾"

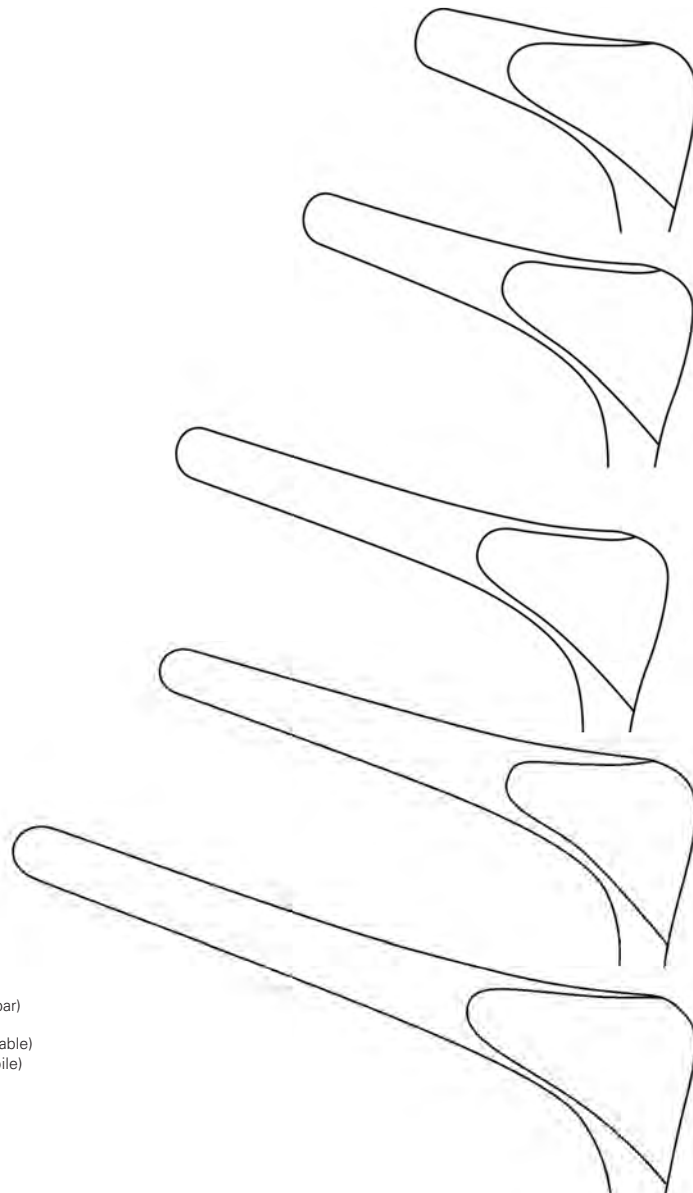




mit aseptischem Verschluss (zerlegbar)  
with aseptic joint (dismantable)  
con articulación aséptica (desmontable)  
con articolazione asettica (smontabile)

## KILLIAN

**26-524-01 - 26-524-05** 14,0 cm, 5 1/2"



40 mm

**26-524-01**

55 mm

**26-524-02**

65 mm

**26-524-03**

75 mm

**26-524-04**

90 mm

**26-524-05**

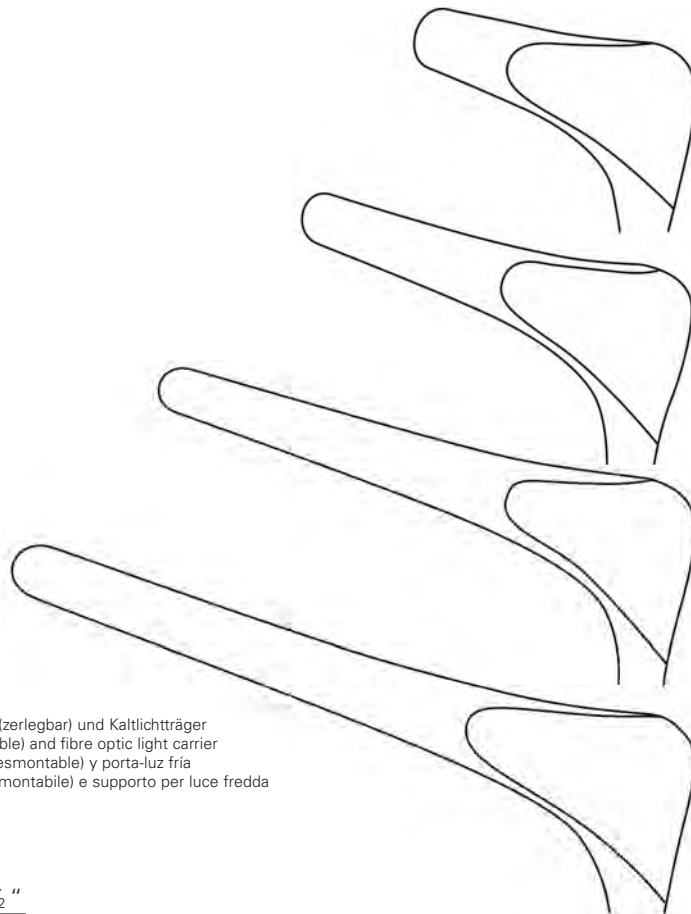


AMNOTEC  
KARL STORZ  
OLYMPUS  
ACMI  
RICHARD WOLF

mit aseptischem Verschluss (zerlegbar) und Kaltlichtträger  
with aseptic joint (dismantable) and fibre optic light carrier  
con articulación aséptica (desmontable) y porta-luz fría  
con articolazione asettica (smontabile) e supporto per luce fredda

**KILLIAN**

**26-524-01 KL - 26-524-04 KL** 14,0 cm, 5 ½"



40 mm  
**26-524-01 KL**

55 mm  
**26-524-02 KL**

75 mm  
**26-524-03 KL**

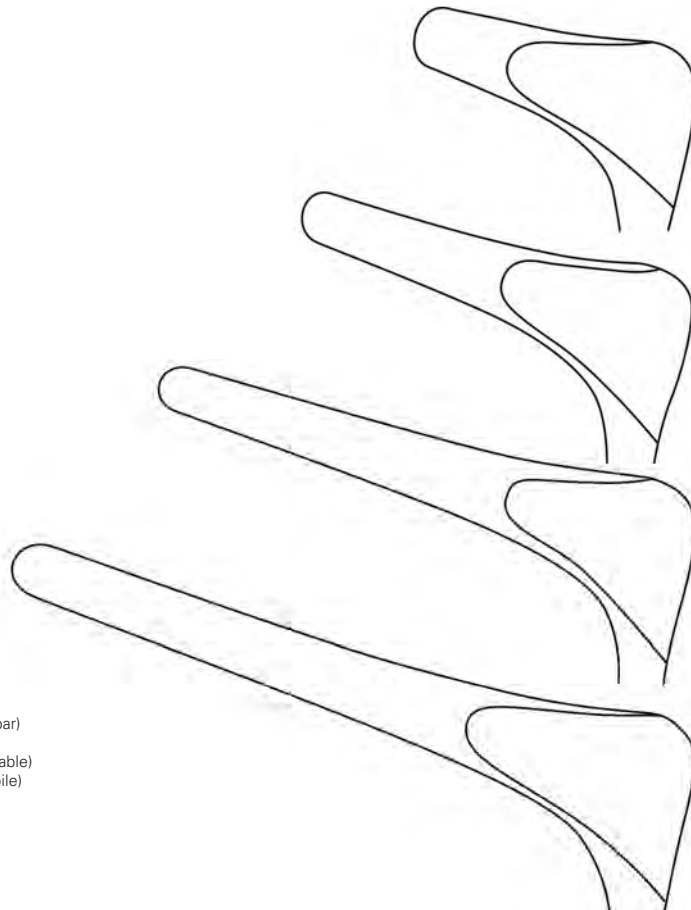
90 mm  
**26-524-04 KL**



mit aseptischem Verschluss (zerlegbar)  
with aseptic joint (dismantable)  
con articulación aséptica (desmontable)  
con articolazione asettica (smontabile)

**KILLIAN**

**26-524-11 - 26-524-14** 14,0 cm, 5 ½"



40 mm  
**26-524-11**

55 mm  
**26-524-12**

75 mm  
**26-524-13**

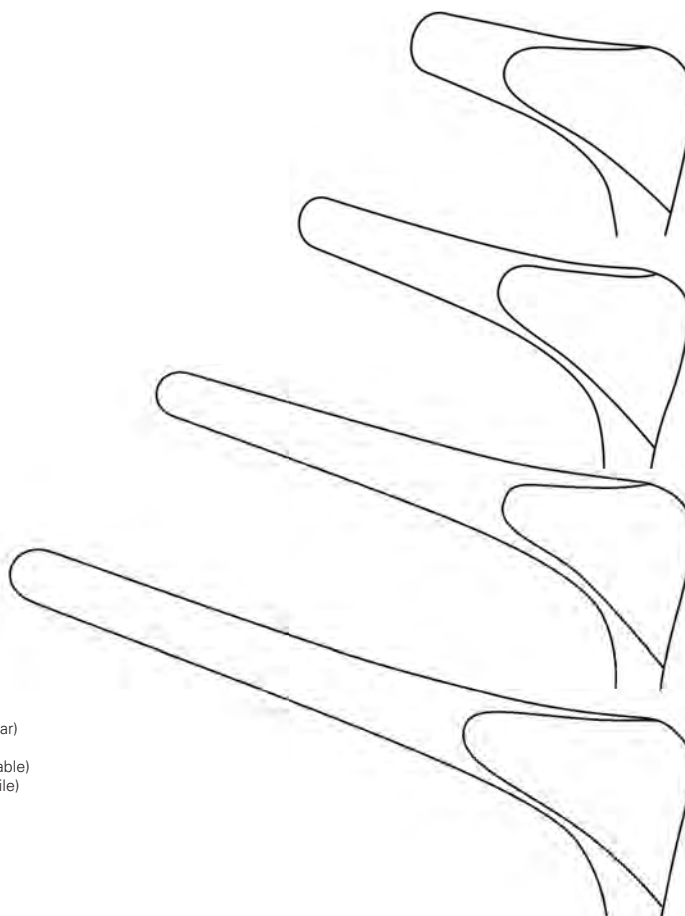
90 mm  
**26-524-14**



Aufnahme für flexiblen Spannarm  
Adaption for flexible arm  
Adaptación para brazo flexible  
Adattatore per braccio flessibile



mit aseptischem Verschluss (zerlegbar)  
with aseptic joint (dismantable)  
con articulación aséptica (desmontable)  
con articolazione aseptica (smontabile)



40 mm  
**26-524-21**

55 mm  
**26-524-22**

75 mm  
**26-524-23**

90 mm  
**26-524-24**

## KILLIAN

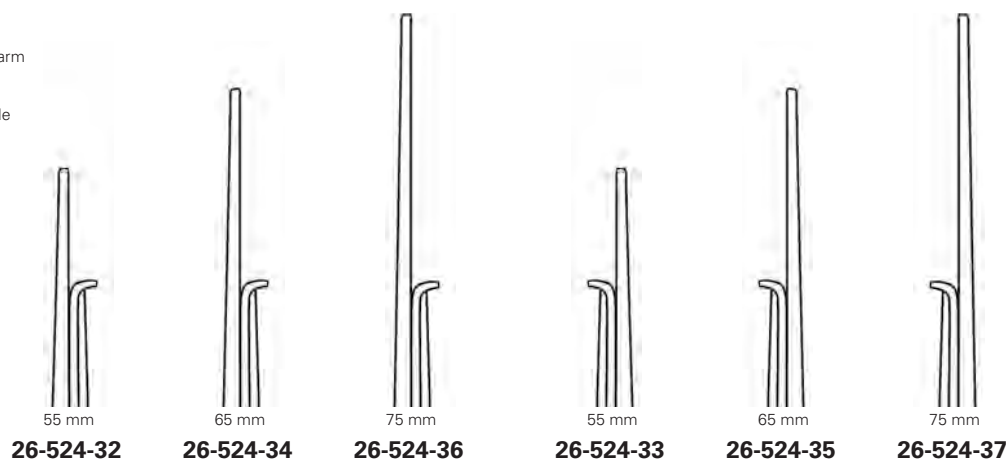
**26-524-21 - 26-524-24** 14,0 cm, 5 1/2 "



Aufnahme für flexiblen Spannarm  
Adaption for flexible arm  
Adaptación para brazo flexible  
Adattatore per braccio flessibile



mit aseptischem Verschluss (zerlegbar)  
with aseptic joint (dismantable)  
con articulación aséptica (desmontable)  
con articolazione aseptica (smontabile)



55 mm  
**26-524-32**

65 mm  
**26-524-34**

75 mm  
**26-524-36**

55 mm  
**26-524-33**

65 mm  
**26-524-35**

75 mm  
**26-524-37**

rechtes Blatt verkürzt mit Zähnen  
right blade shortened with teeth  
hoja derecha acortada con dientes  
lama destra ridotta con denti

linkes Blatt verkürzt mit Zähnen  
left blade shortened with teeth  
hoja izquierda acortada con dientes  
lama sinistra ridotta con denti

## KILLIAN-RUDERT

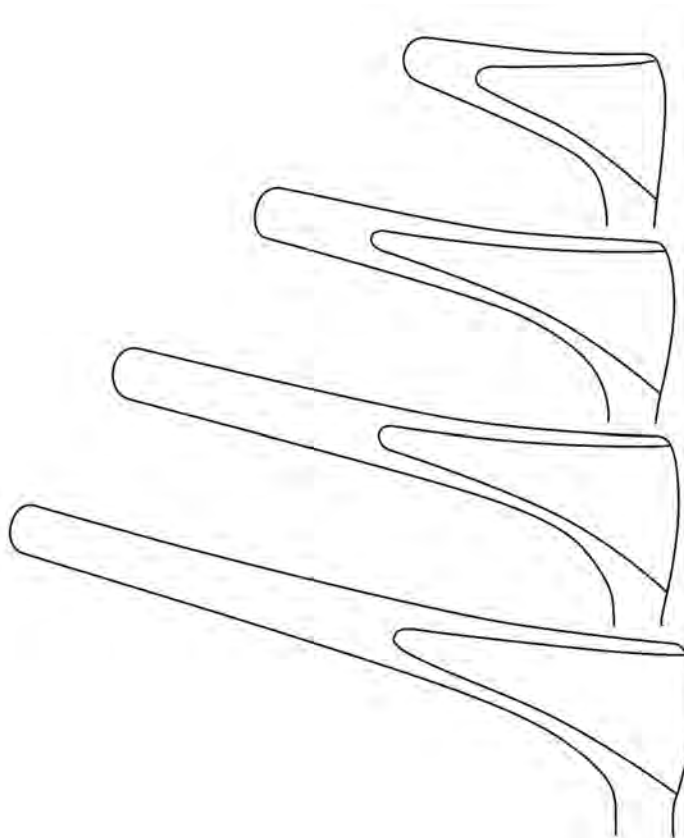
**26-524-32 - 26-524-37** 14,0 cm, 5 1/2 "



mit Schraubschluß  
with screw joint  
con articulación de tornillo  
con articolazione a vite

**KILLIAN**

**26-525-01 - 26-525-04** 14,0 cm, 5 ½"



40 mm  
**26-525-01**

55 mm  
**26-525-02**

75 mm  
**26-525-03**

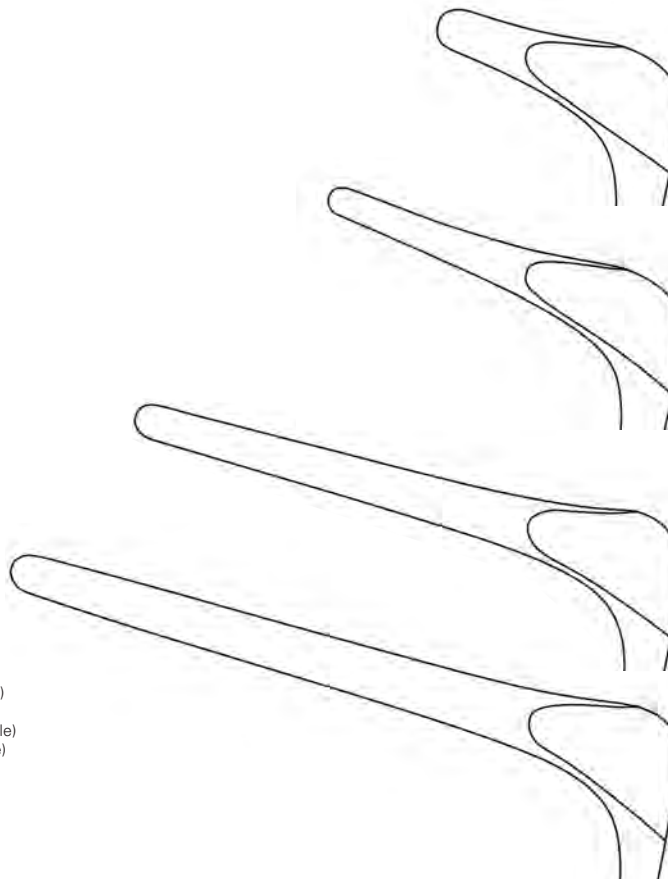
90 mm  
**26-525-04**



mit aseptischem Verschuß (zerlegbar)  
with aseptic joint (dismantable)  
con articulación aséptica (desmontable)  
con articolazione asettica (smontabile)

**COTTLE**

**26-528-01 - 26-528-04** 15,0 cm, 6"



35 mm  
**26-528-01**

55 mm  
**26-528-02**

75 mm  
**26-528-03**

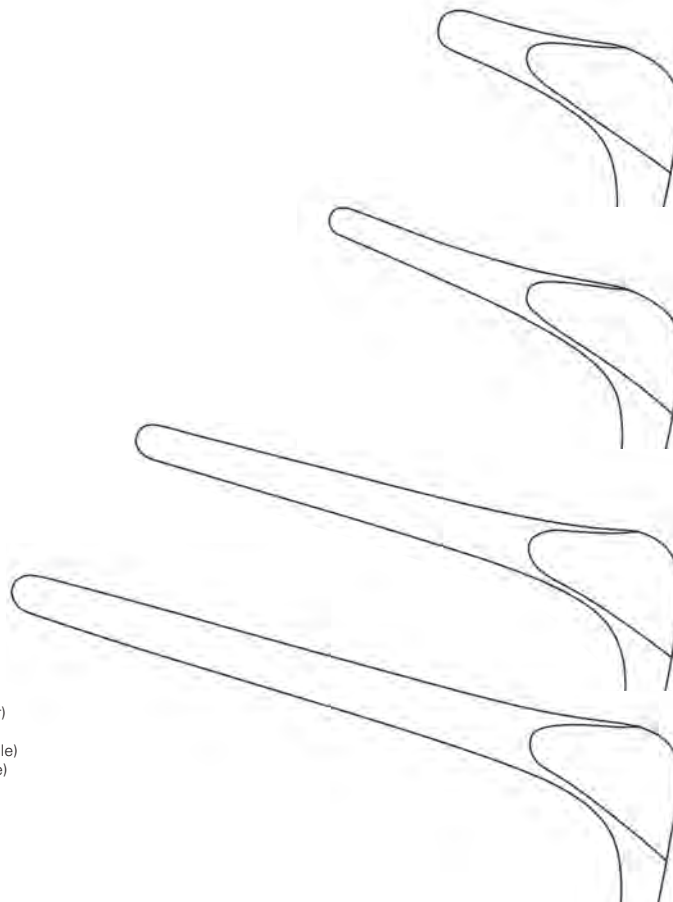
90 mm  
**26-528-04**



mit aseptischem Verschluss (zerlegbar)  
 with aseptic joint (dismantable)  
 con articulación aséptica (desmontable)  
 con articolazione aseptica (smontabile)

**COTTLE**

**26-529-01 - 26-529-04** 15,0 cm, 6"



35 mm  
**26-529-01**

55 mm  
**26-529-02**

75 mm  
**26-529-03**

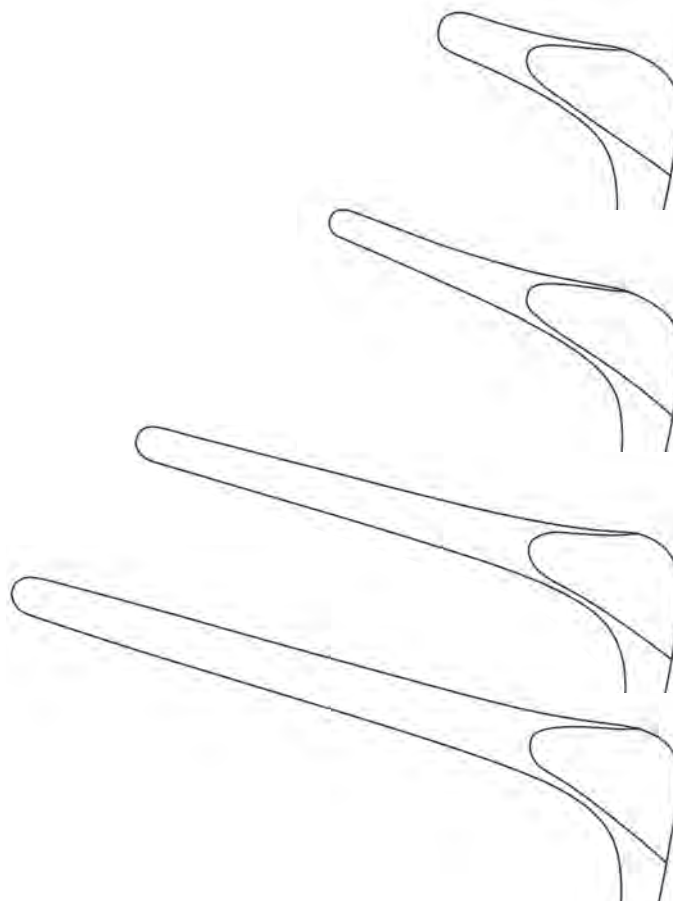
90 mm  
**26-529-04**



mit Schraubschluss  
 with screw joint  
 con articulación de tornillo  
 con articolazione a vite

**COTTLE**

**26-530-01 - 26-530-04** 14,0 cm, 5 1/2"



35 mm  
**26-530-01**

50 mm  
**26-530-02**

75 mm  
**26-530-03**

90 mm  
**26-530-04**



mit aseptischem Verschluss (zerlegbar)  
with aseptic joint (dismantable)  
con articulación aséptica (desmontable)  
con articolazione asettica (smontabile)

**COTTLE**

**26-532-13** 13,0 cm, 5 3/4"



mit aseptischem Verschluss (zerlegbar)  
with aseptic joint (dismantable)  
con articulación aséptica (desmontable)  
con articolazione asettica (smontabile)

**COTTLE**

**26-533-13** 13,0 cm, 5 3/4"



rechtes Blatt verkürzt  
right blade shortened  
hoja derecha acortada  
lama destra ridotta

mit aseptischem Verschluss (zerlegbar)  
with aseptic joint (dismantable)  
con articulación aséptica (desmontable)  
con articolazione asettica (smontabile)

**COTTLE**

**26-535-01** 15,0 cm, 6"

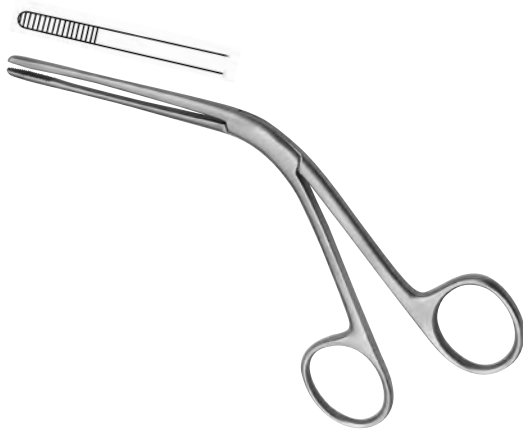


linkes Blatt verkürzt  
left blade shortened  
hoja izquierda acortada  
lama sinistra ridotta

mit aseptischem Verschluss (zerlegbar)  
with aseptic joint (dismantable)  
con articulación aséptica (desmontable)  
con articolazione asettica (smontabile)

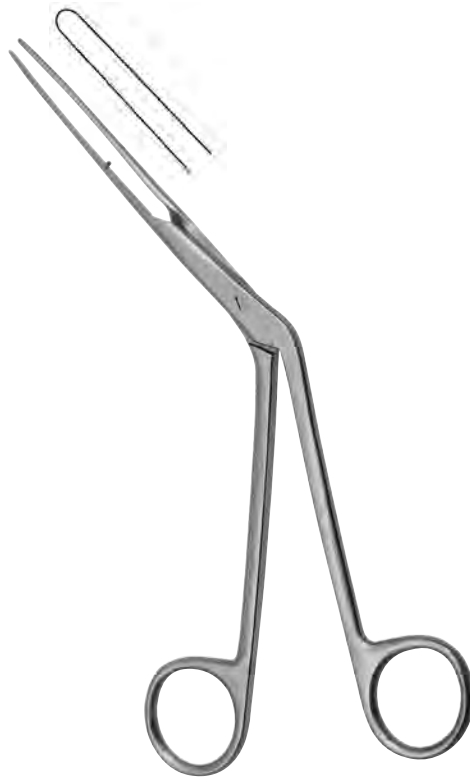
**COTTLE**

**26-535-02** 15,0 cm, 6"



**TILLEY**

**26-601-13** 14,0 cm, 5 ½"



**LUBET-BARBON**

**26-603-20** 20,0 cm, 8"



**WESTMACOTT**

**26-604-20** 20,0 cm, 8"



**HARTMANN**

**26-607-16** 16,0 cm, 6 ¼"



**HARTMANN**

**26-607-20** 20,0 cm, 8"





**KILLIAN**

**26-609-17** 17,0 cm, 6  $\frac{3}{4}$ "



**HEYMANN-KNIGHT**

**26-609-18** 18,0 cm, 7"



**LITTAUER**

**26-611-18** 18,0 cm, 7"



**HARTMANN**

**26-615-19** 19,0 cm, 7  $\frac{1}{2}$ "





### KRAUSE

**26-621-26** 26,0 cm, 10 ¼"



### KRAUSE-VOSS

**26-623-26** 26,0 cm, 10 ¼"



### LANGE-WILDE

**26-624-24** 24,0 cm, 9 ½"



Verpackungseinheit: 12 St.  
 Packing unit: 12 pieces  
 Unidad: 12 piezas  
 Confezione: 12 pezzi

Schnürdrähte  
 Snare wires  
 Alambre para amigdalótomo  
 Filo per serranodi



**26-627-30** Ø 0,3 mm  
**26-627-40** Ø 0,4 mm



Verpackungseinheit: 100 St.  
 Packing unit: 100 pieces  
 Unidad: 100 piezas  
 Confezione: 100 pezzi

Schnürdrähte  
 Snare wires  
 Alambre para amigdalótomo  
 Filo per serranodi

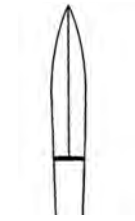


**26-627-93** Ø 0,3 mm  
**26-627-94** Ø 0,4 mm

Schnürdrähte, Rolle mit 10 m  
 Snare wires, coil of 10 m  
 Alambre para amigdalótomo, rollo de 10 m  
 Filo per serranodi, rotolo da 10 m



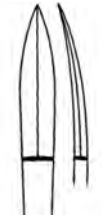
**26-158-02** Ø 0,2 mm  
**26-158-03** Ø 0,3 mm  
**26-158-04** Ø 0,4 mm



**26-640-14**

gerade  
straight  
recta  
retto

Nasenplastikmesser  
Rhinoplastic knives  
Cuchillos para rinoplástica  
Coltelli per plastica nasale



**26-641-14**

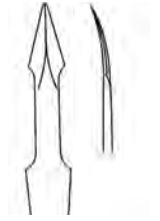
gebogen  
curved  
curva  
curvo



**26-642-99**

Ersatzklinge  
Spare blade  
Hoja de repuesto  
Lama di ricambio

Septummesser  
Septum knife  
Cuchillos para el tabique nasal  
Coltelli per setto nasale



**26-645-14**

gebogen  
curved  
curva  
curvo

Knorpelritzmesser  
Cartilage slitting knife  
Cuchillos para rajar cartilagos  
Coltelli per scalfire la cartilagine

**JOSEPH**

**26-640-14 - 26-641-14** 14,5 cm, 5 3/4"

**BRUENINGS**

**26-642-16** 16,0 cm, 6 1/4"

**MASING**

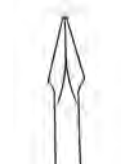
**26-645-14** 14,0 cm, 5 1/2"



**26-644-13**

gebogen  
curved  
curva  
curvo

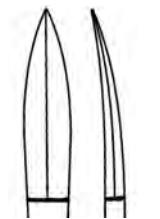
Knorpelritzmesser  
Cartilage slitting knife  
Cuchillos para rajar cartilagos  
Coltelli per scalfire la cartilagine



**26-644-14**

gerade  
straight  
recta  
retto

Knorpelritzmesser  
Cartilage slitting knife  
Cuchillos para rajar cartilagos  
Coltelli per scalfire la cartilagine



**26-645-16**



Nasenplastikmesser  
Rhinoplastic knife  
Cuchillos para rinoplástica  
Coltelli per plastica nasale

**MASING**

**26-644-13** 13,5 cm, 5 1/4"

**MASING**

**26-644-14** 13,5 cm, 5 1/4"

**FOMON**

**26-645-16** 16,0 cm, 6 1/4"



**26-646-15**

Mukosamesser  
 Mucosa knife  
 Cuchillos para mucosa  
 Coltelli per mucosa

**FREER**

**26-646-15** 15,5 cm, 6 1/8"



**26-647-17**

Septummesser  
 Septum knife  
 Cuchillos para el tabique nasal  
 Coltelli per setto nasale

**JOSEPH**

**26-647-17** 17,5 cm, 7"



**26-649-16**

Nasenplastikmesser  
 Rhinoplastic knife  
 Cuchillos para rinoplástica  
 Coltelli per plastica nasale

**CONVERSE**

**26-649-16** 16,0 cm, 6 1/4"



**26-650-15**

Nasenplastikmesser  
 Rhinoplastic knife  
 Cuchillos para rinoplástica  
 Coltelli per plastica nasale

**JOSEPH**

**26-650-15** 15,0 cm, 6"



**26-652-15**

Nasenplastikmesser  
 Rhinoplastic knife  
 Cuchillos para rinoplástica  
 Coltelli per plastica nasale

**COTTLE**

**26-652-15** 15,0 cm, 6"



**26-654-15**

Nasenplastikmesser  
 Rhinoplastic knife  
 Cuchillos para rinoplástica  
 Coltelli per plastica nasale

**COTTLE**

**26-654-15** 15,0 cm, 6"



3,3 mm  
**26-655-18**

**HALLE**

**26-655-18** 18,0 cm, 7 "



Ø 4,0 mm  
**26-660-21**

Saugelevator  
 Suction elevator  
 Elevador de succión  
 Elevatori d'aspirazione

**FREER-GORNEY**

**26-660-21** 21,0 cm, 8 ¼ "



**26-661-18**

**FREER**

**26-661-18** 17,5 cm, 7 "

scharf  
 sharp  
 agudo  
 acuto



5,0 mm  
**26-663-18**  
 5,0 mm

stumpf  
 blunt  
 romo  
 smusso

**FREER**

**26-663-18** 18,0 cm, 7 "

scharf  
 sharp  
 agudo  
 acuto



3,0 mm  
**26-663-19**  
 3,0 mm

scharf  
 sharp  
 agudo  
 acuto

**FREER-YASARGIL**

**26-663-19** 18,5 cm, 7 ¼ "

scharf  
 sharp  
 agudo  
 acuto



6,5 mm  
**26-663-20**  
 6,5 mm

stumpf  
 blunt  
 romo  
 smusso

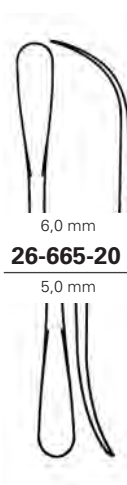
**FREER**

**26-663-20** 20,0 cm, 8 "



**FREER-JOSEPH**

**26-663-21** 20,0 cm, 8"



**26-665-20**

**FREER**

**26-665-20** 20,0 cm, 8"



**26-668-19**

**FREER**

**26-668-19** 19,0 cm, 7 1/2"



**26-669-01**

**FREER**

**26-669-01** 19,0 cm, 7 1/2"



**26-669-02**

**FREER**

**26-669-02** 19,0 cm, 7 1/2"



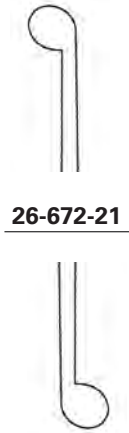
**26-669-03**

**FREER**

**26-669-03** 19,0 cm, 7 1/2"



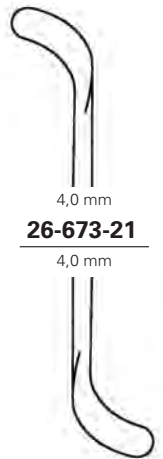
**26-670-17** 17,0 cm, 6 3/4"



**26-672-21**

**PIERCE**

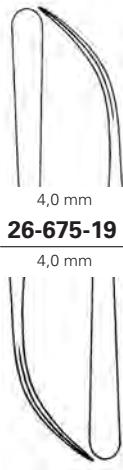
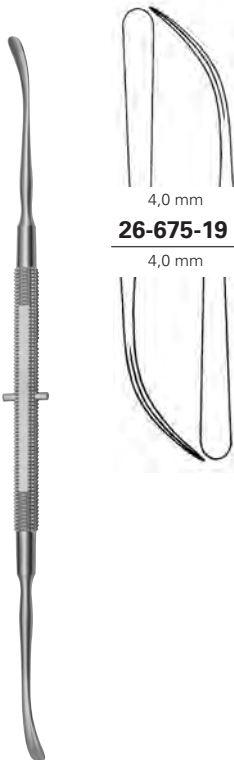
**26-672-21** 21,0 cm, 8 1/4"



**26-673-21**

**PENNINGTON**

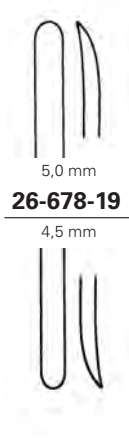
**26-673-21** 21,0 cm, 8 1/4"



**26-675-19**

**ROGER**

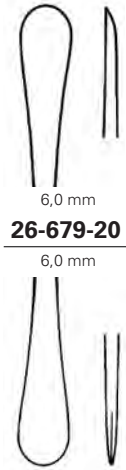
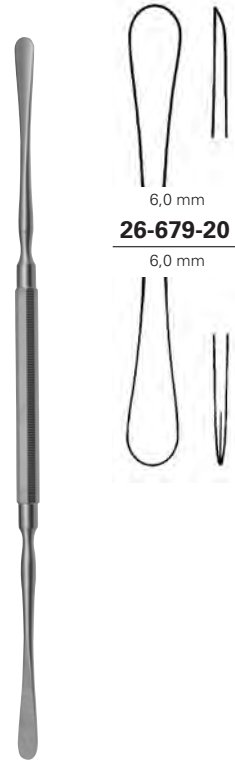
**26-675-19** 19,0 cm, 7 1/2"



**26-678-19**

**MC KENTY**

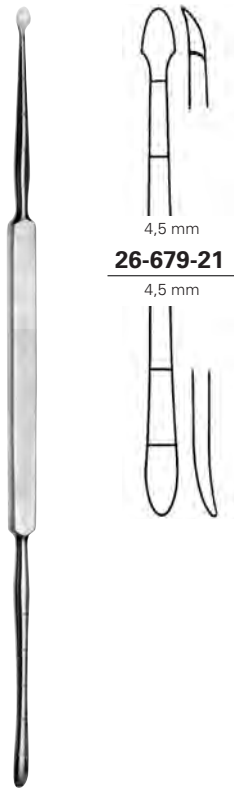
**26-678-19** 19,0 cm, 7 1/2"



**26-679-20**

**BALLENGER-HAJEK**

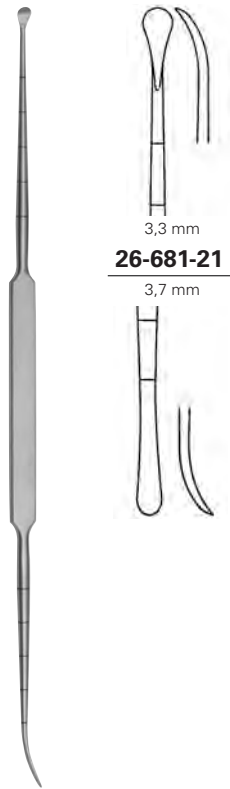
**26-679-20** 19,0 cm, 7 1/2"



**26-679-21**  
4,5 mm

**COTTLE**

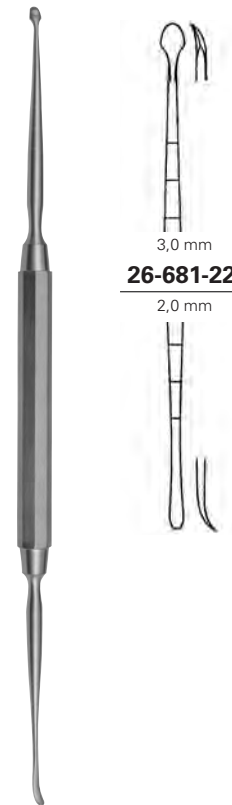
**26-679-21** 21,0 cm, 8 ¼"



**26-681-21**  
3,3 mm  
3,7 mm

**COTTLE**

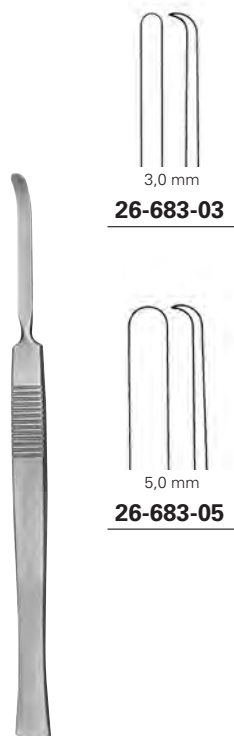
**26-681-21** 21,0 cm, 8 ¼"



**26-681-22**  
3,0 mm  
2,0 mm

**MASING**

**26-681-22** 22,0 cm, 8 ¾"



**26-683-03**  
3,0 mm

**26-683-04**  
4,0 mm

**26-683-05**  
5,0 mm

**MC KENTY**

**26-683-03 - 26-683-05** 15,0 cm, 6"



**26-687-16**  
6,5 mm

**JOSEPH**

**26-687-16** 16,0 cm, 6 ¼"



**26-688-22**  
4,0 mm

**JOSEPH-MASING**

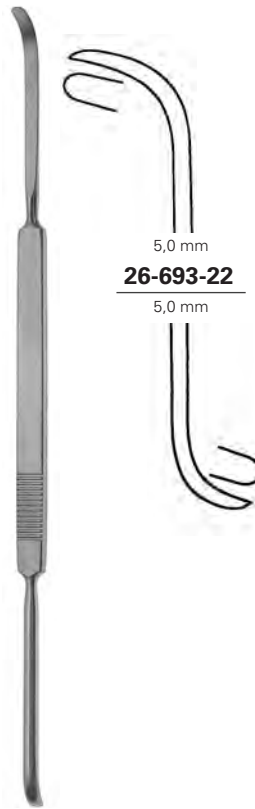
**26-688-22** 22,0 cm, 8 ¾"



**26-689-18**

**KILLIAN**

**26-689-18** 18,0 cm, 7"



**26-693-22**

**COTTLE**

**26-693-22** 23,0 cm, 9"



**26-695-22**

**HOWARTH**

**26-695-22** 21,5 cm, 8 1/2"



Ø 3,5 mm

Saugraspatorium  
 Suction raspatory  
 Legra de succión  
 Periototomi d'aspirazione

**GUILEN**

**26-697-14** 14,5 cm, 5 3/4"



Ø 3,5 mm

Saugraspatorium  
 Suction raspatory  
 Legra de succión  
 Periototomi d'aspirazione

**GUILEN**

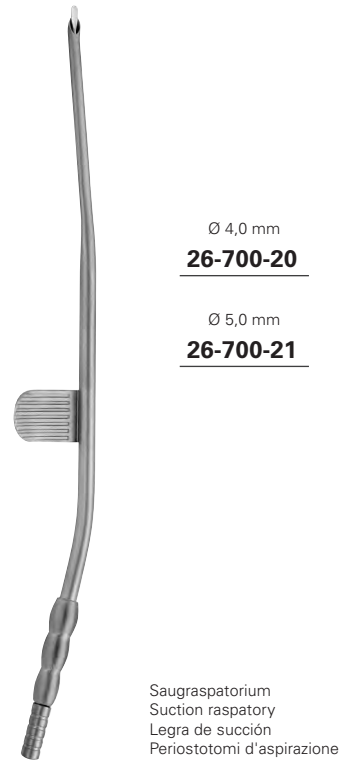
**26-698-14** 14,5 cm, 5 3/4"



Ø 4,0 mm

Saugraspatorium  
 Suction raspatory  
 Legra de succión  
 Periototomi d'aspirazione

**26-699-20** 20,0 cm, 8"



Ø 4,0 mm

**26-700-20**

Ø 5,0 mm

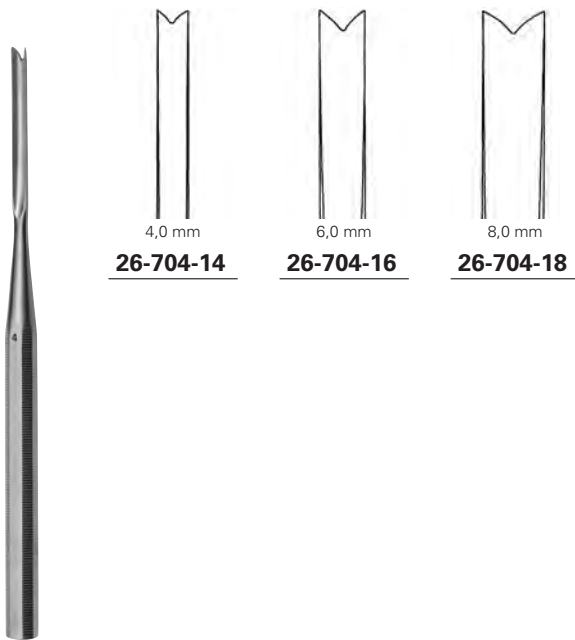
**26-700-21**

Saugraspatorium  
 Suction raspatory  
 Legra de succión  
 Periototomi d'aspirazione

**26-700-20** 20,0 cm, 8"

**26-700-21** 20,0 cm, 8"





**26-704-14**

**26-704-16**

**26-704-18**

**BALLENGER**

**26-704-14 - 26-704-18** 15,5 cm, 6"



**26-705-17**

**KILLIAN**

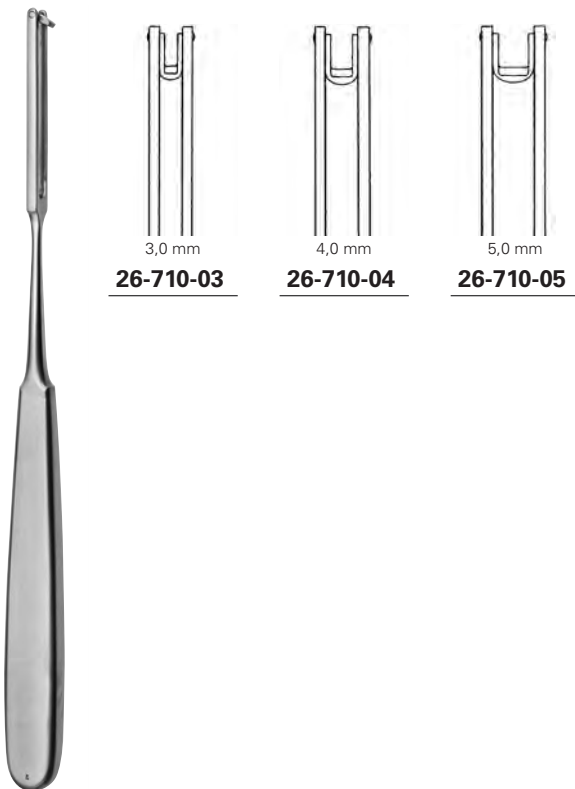
**26-705-17** 17,0 cm, 6 3/4"



**26-707-17**

**KILLIAN-CLAUS**

**26-707-17** 17,0 cm, 6 3/4"



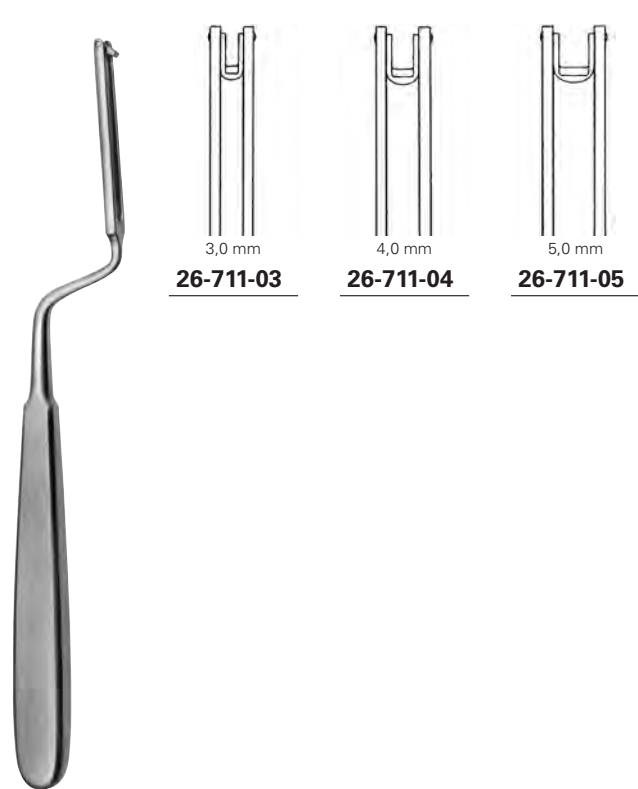
**26-710-03**

**26-710-04**

**26-710-05**

**BALLENGER**

**26-710-03 - 26-710-05** 21,0 cm, 8 1/4"



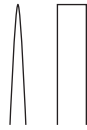
**26-711-03**

**26-711-04**

**26-711-05**

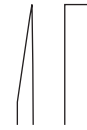
**BALLENGER**

**26-711-03 - 26-711-05** 20,0 cm, 8"



<b>40-278-04</b>	4,0 mm
<b>40-278-06</b>	6,0 mm
<b>40-278-08</b>	8,0 mm
<b>40-278-10</b>	10,0 mm
<b>40-278-12</b>	12,0 mm

Osteotome, graduiert  
 Osteotomes, graduated  
 Osteótomos, graduado  
 Osteotomi, graduato



<b>40-279-04</b>	4,0 mm
<b>40-279-05</b>	5,0 mm
<b>40-279-06</b>	6,0 mm
<b>40-279-07</b>	7,0 mm
<b>40-279-09</b>	9,0 mm
<b>40-279-12</b>	12,0 mm

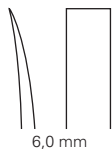
Flachmeißel, graduiert  
 Chisels, graduated  
 Cinceles, graduado  
 Scalpelli, graduato

**COTTLE**

**40-278-04 - 40-278-12** 18,0 cm, 7 "

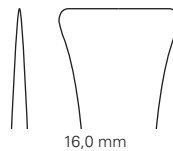
**COTTLE**

**40-279-04 - 40-279-12** 18,0 cm, 7 "



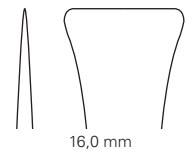
**26-721-06**

Osteotom, graduiert  
 Osteotome, graduated  
 Osteótomo, graduado  
 Osteotomo, graduato



**26-724-16**

Osteotom, graduiert  
 Osteotome, graduated  
 Osteótomo, graduado  
 Osteotomo, graduato



**26-726-16**

Osteotom, graduiert  
 Osteotome, graduated  
 Osteótomo, graduado  
 Osteotomo, graduato

**COTTLE**

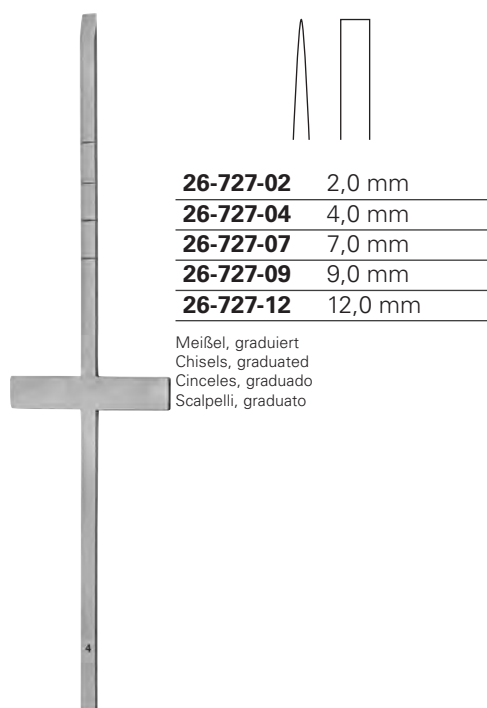
**26-721-06** 18,0 cm, 7 "

**COTTLE**

**26-724-16** 18,0 cm, 7 "

**COTTLE**

**26-726-16** 18,0 cm, 7 "

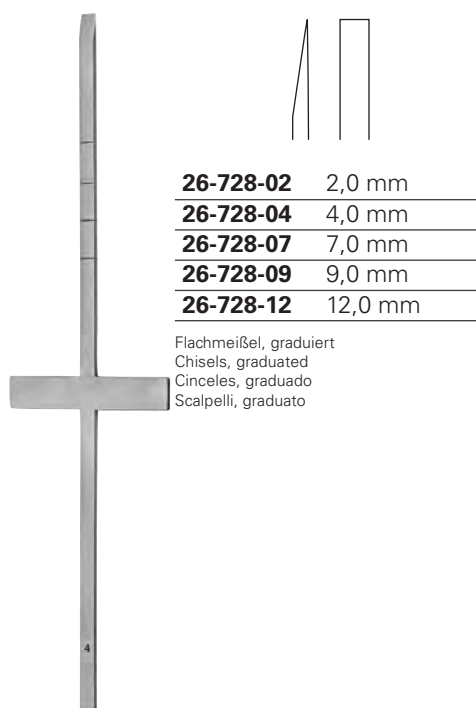


<b>26-727-02</b>	2,0 mm
<b>26-727-04</b>	4,0 mm
<b>26-727-07</b>	7,0 mm
<b>26-727-09</b>	9,0 mm
<b>26-727-12</b>	12,0 mm

Meißel, graduiert  
 Chisels, graduated  
 Cinceles, graduado  
 Scalpelli, graduato

### COTTLE

**26-727-02 - 26-727-12** 18,5 cm, 7 ¼"

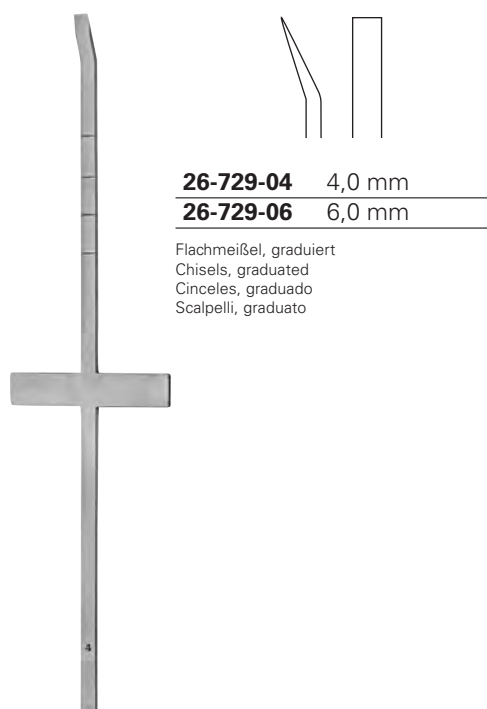


<b>26-728-02</b>	2,0 mm
<b>26-728-04</b>	4,0 mm
<b>26-728-07</b>	7,0 mm
<b>26-728-09</b>	9,0 mm
<b>26-728-12</b>	12,0 mm

Flachmeißel, graduiert  
 Chisels, graduated  
 Cinceles, graduado  
 Scalpelli, graduato

### COTTLE

**26-728-02 - 26-728-12** 18,5 cm, 7 ¼"

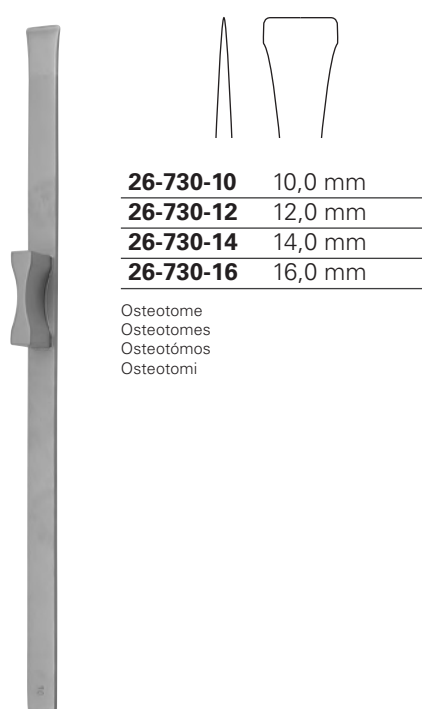


<b>26-729-04</b>	4,0 mm
<b>26-729-06</b>	6,0 mm

Flachmeißel, graduiert  
 Chisels, graduated  
 Cinceles, graduado  
 Scalpelli, graduato

### COTTLE

**26-729-04 - 26-729-06** 18,5 cm, 7 ¼"



<b>26-730-10</b>	10,0 mm
<b>26-730-12</b>	12,0 mm
<b>26-730-14</b>	14,0 mm
<b>26-730-16</b>	16,0 mm

Osteotome  
 Osteotomes  
 Osteótomos  
 Osteotomi

### RUBIN

**26-730-10 - 26-730-16** 18,0 cm, 7"



<b>26-732-03</b>	3,0 mm
<b>26-732-04</b>	4,5 mm

Flachmeißel  
 Chisels  
 Cinceles  
 Scalpelli



<b>26-733-02</b>	2,0 mm
<b>26-733-03</b>	3,0 mm
<b>26-733-04</b>	4,0 mm
<b>26-733-07</b>	7,0 mm
<b>26-733-09</b>	9,0 mm
<b>26-733-12</b>	12,0 mm

Osteotome  
 Osteotomes  
 Osteótomos  
 Osteotomi

**WALTER**

**26-732-03 - 26-732-04** 18,0 cm, 7 "

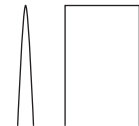
**WALTER**

**26-733-03 - 26-733-12** 18,0 cm, 7 "



<b>26-734-01</b>	1,0 mm
<b>26-734-02</b>	2,0 mm
<b>26-734-03</b>	3,0 mm
<b>26-734-04</b>	4,0 mm
<b>26-734-05</b>	5,0 mm
<b>26-734-06</b>	6,0 mm
<b>26-734-07</b>	7,0 mm
<b>26-734-08</b>	8,0 mm
<b>26-734-10</b>	10,0 mm
<b>26-734-12</b>	12,0 mm

Osteotome  
 Osteotomes  
 Osteótomos  
 Osteotomi



<b>26-735-02</b>	2,0 mm
<b>26-735-03</b>	3,0 mm
<b>26-735-04</b>	4,0 mm
<b>26-735-05</b>	5,0 mm
<b>26-735-06</b>	6,0 mm
<b>26-735-07</b>	7,0 mm
<b>26-735-08</b>	9,0 mm
<b>26-735-09</b>	9,0 mm
<b>26-735-10</b>	10,0 mm
<b>26-735-11</b>	11,0 mm
<b>26-735-12</b>	12,0 mm
<b>26-735-14</b>	14,0 mm

Osteotome  
 Osteotomes  
 Osteótomos  
 Osteotomi

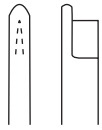


**SHEEHAN**

**26-734-01 - 26-734-12** 15,5 cm, 6 1/8 "

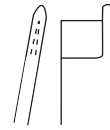
**CONVERSE**

**26-735-02 - 26-735-14** 18,0 cm, 7 "



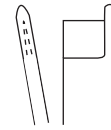
<b>26-736-04</b>	4,0 mm
<b>26-736-05</b>	5,0 mm
<b>26-736-06</b>	6,0 mm
<b>26-736-07</b>	7,0 mm

Osteotome  
 Osteotomes  
 Osteótomos  
 Osteotomi



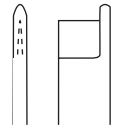
**26-737-01**

rechts gebogen  
 curved to right  
 curva a la derecha  
 curvo verso destra



**26-737-02**

links gebogen  
 curved to left  
 curva a la izquierda  
 curvo verso sinistra



**26-737-03**

gerade  
 straight  
 recta  
 retto

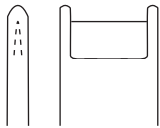
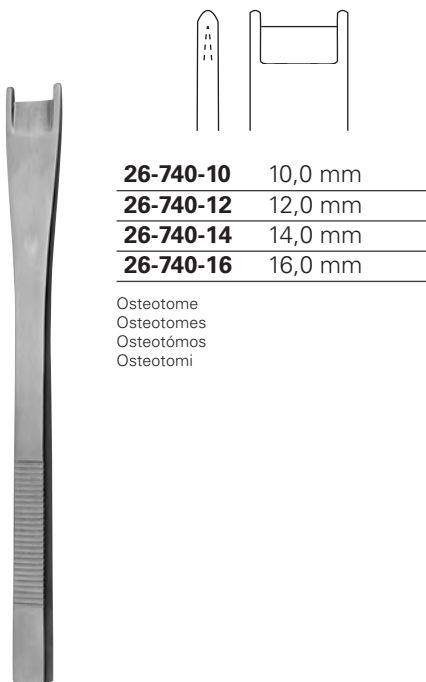
Osteotome  
 Osteotomes  
 Osteótomos  
 Osteotomi

## FOMON

**26-736-04 - 26-736-07** 17,0 cm, 6 3/4 "

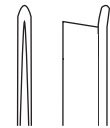
## NEIVERT-ANDERSON

**26-737-01 - 26-737-03** 20,5 cm, 8 "



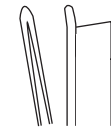
<b>26-740-10</b>	10,0 mm
<b>26-740-12</b>	12,0 mm
<b>26-740-14</b>	14,0 mm
<b>26-740-16</b>	16,0 mm

Osteotome  
 Osteotomes  
 Osteótomos  
 Osteotomi



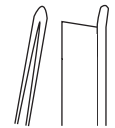
**26-741-01**

gerade  
 straight  
 recta  
 retto



**26-741-02**

links gebogen  
 curved to left  
 curva a la izquierda  
 curvo verso sinistra



**26-741-03**

rechts gebogen  
 curved to right  
 curva a la derecha  
 curvo verso destra

Osteotome  
 Osteotomes  
 Osteótomos  
 Osteotomi

## CINELLI

**26-740-10 - 26-740-16** 16,0 cm, 6 1/4 "

## SILVER

**26-741-01 - 26-741-03** 17,5 cm, 7 "



**26-743-01**

links  
left  
izquierda  
sinistra



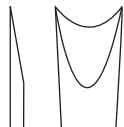
**26-743-02**

rechts  
right  
derecha  
destra

Osteotome  
Osteotomes  
Osteótomos  
Osteotomi

## GUSTELLA

**26-743-01 - 26-743-02** 17,5 cm, 7"



**26-744-09** 9,0 mm

**26-744-11** 11,0 mm

**26-744-13** 13,0 mm

**26-744-15** 15,0 mm

Osteotome  
Osteotomes  
Osteótomos  
Osteotomi

## MC INDOE

**26-744-09 - 26-744-15** 14,5 cm, 5 3/4"



links abgewinkelt  
angled to left  
angulado por izquierdo  
angolato a sinistra

## JOSEPH

**26-751-01** 17,0 cm, 6 <sup>3</sup>/<sub>4</sub> "



rechts abgewinkelt  
angled to right  
angulado por derecho  
angolato a destra

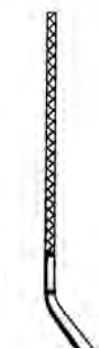
## JOSEPH

**26-751-02** 17,0 cm, 6 <sup>3</sup>/<sub>4</sub> "



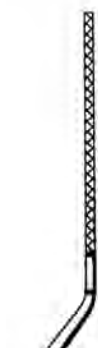
**26-752-01**

gerade  
straight  
recta  
retto



**26-752-02**

links gebogen  
curved to left  
curva a la izquierda  
curvo verso sinistra



**26-752-03**

rechts gebogen  
curved to right  
curva a la derecha  
curvo verso destra

## JOSEPH

**26-752-01 - 26-752-03** 19,0 cm, 7 <sup>1</sup>/<sub>2</sub> "

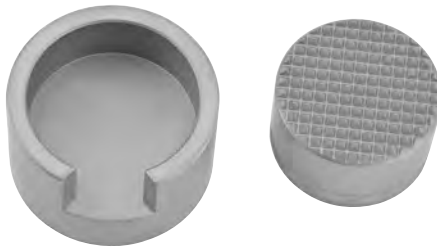
Biegegerät zum Formen von Drahtprothesen  
 Die to pre-form wire prothesis  
 Aparato de doblar para moldear prótesis metálicas  
 Strumento curvo per modellare fili guida



**SCHUHKNECHT**

**26-754-00**

Knorpelquetsche  
 Cartilage Crusher  
 Machacadora  
 Torchio per cartilagine



**26-755-00**

Knorpelquetsche  
 Cartilage Crusher  
 Machacadora  
 Torchio per cartilagine



**COTTLE**

**26-756-00**

Columellapinzette  
 Columella forceps  
 Pinza para columela  
 Pinza per columella



**26-760-10**

**COTTLE**

**26-760-10** 10,0 cm, 4 "

Fixierpinzette  
 Fixation forceps  
 Pinza de fijacion  
 Pinza di fissaggio

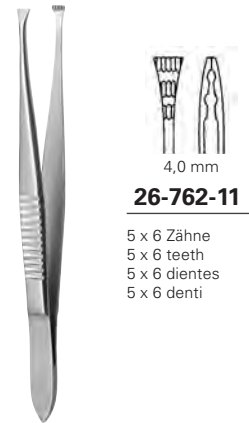


**26-761-14**

**COTTLE**

**26-761-14** 14,0 cm, 5 1/2 "

Hautfasspinzette  
 Skin grasping forceps  
 Pinza para coger la piel  
 Pinza per afferrare la pelle



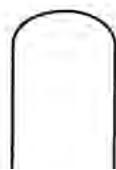
**26-762-11**

5 x 6 Zähne  
 5 x 6 teeth  
 5 x 6 dientes  
 5 x 6 denti

**GRAEFE**

**26-762-11** 11,0 cm, 4 1/4 "





<b>26-766-01</b>	18 x 9,5 mm
<b>26-766-02</b>	28 x 12,5 mm
<b>26-766-03</b>	41 x 13,5 mm
<b>26-766-04</b>	53 x 13,5 mm



55 x 10 mm  
**26-767-00**

mit Fiberglas-Lichtträger und Lichtquelle  
 with fiberoptic light carrier and light source  
 con portador de luz de fibra de vidrio y fuente de luz  
 con supporto in vetroresina e fonte luminosa

## CONVERSE

**26-766-01 - 26-766-04** 9,0 cm, 3 1/2"

**26-767-00** 21,5 cm, 8 1/2"



46 x 10 mm  
**26-767-16**



60 x 10 mm  
**26-768-16**



**26-768-19**

## AUFRICHT

**26-767-16 - 26-768-16** 16,0 cm, 6 1/4"

## BRUENINGS-BRUNK

**26-768-19** 19,0 cm, 7 1/2"



**WALTER**

**26-769-13** 13,5 cm, 5 ¼"



**KILNER**

**26-770-10** 8,0 cm, 3 ¼"



10,0 mm

**26-770-10**

scharf  
sharp  
agudo  
acuto



**COTTLE**

**26-770-15** 15,0 cm, 6"



4,0 mm

**26-770-15**

scharf  
sharp  
agudo  
acuto



**CONVERSE**

**26-771-12** 12,0 cm, 4 ¾"



**26-771-12**

scharf  
sharp  
agudo  
acuto



**COTTLE**

**26-772-01 - 26-772-03** 15,0 cm, 6"



**26-772-01**

scharf  
sharp  
agudo  
acuto



**26-772-02**

scharf  
sharp  
agudo  
acuto



**26-772-03**

scharf  
sharp  
agudo  
acuto



**COTTLE**

**26-774-16** 16,0 cm, 6 ¼"



**26-774-16**

scharf  
sharp  
agudo  
acuto



**FOMON**

**26-776-17** 17,0 cm, 6 ¾"



**26-776-17**



**FOMON**

**26-777-00** 5,5 cm, 2 1/8"



**COTTLE**

**26-778-01 - 26-778-03** 14,5 cm, 5 3/4"



**26-778-01**

spitz | spitz  
sharp | sharp  
agudo | agudo  
acuto | acuto



**26-778-02**

stumpf | spitz  
blunt | sharp  
romo | agudo  
smusso | acuto



**26-778-03**

spitz | stumpf  
sharp | blunt  
agudo | romo  
acuto | smusso



**COTTLE**

**26-778-04** 14,0 cm, 5 1/2"



**26-778-04**

stumpf  
blunt  
romo  
smusso



**MILLARD (COTTLE)**

**26-779-05** 5,5 cm, 2 1/8"



10,0 mm

**26-779-05**

scharf  
sharp  
agudo  
acuto



**FOMON**

**26-779-16** 16,0 cm, 6 1/4"



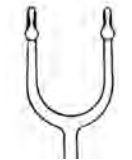
**26-779-16**

stumpf | stumpf  
blunt | blunt  
romo | romo  
smusso | smusso



**COTTLE-NEIVERT**

**26-780-20** 20,0 cm, 8"



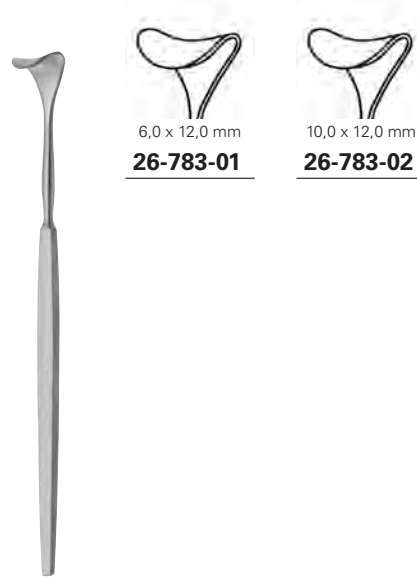
**26-780-20**





**NEIVERT**

**26-782-16** 16,0 cm, 6 ¼"



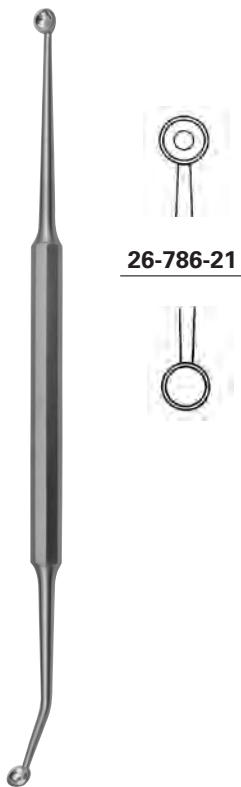
**MASING**

**26-783-01 - 26-783-02** 14,0 cm, 5 ½"



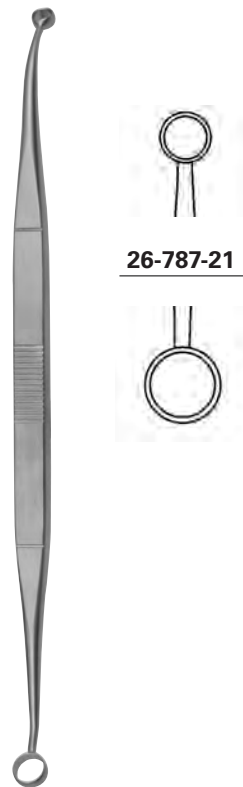
**COTTLE**

**26-785-15** 15,0 cm, 6"



**PRATT**

**26-786-21** 21,0 cm, 8 ¼"



**FAULKNER**

**26-787-21** 21,0 cm, 8 ¼"



**COAKLEY**

**26-788-20** 20,0 cm, 8"

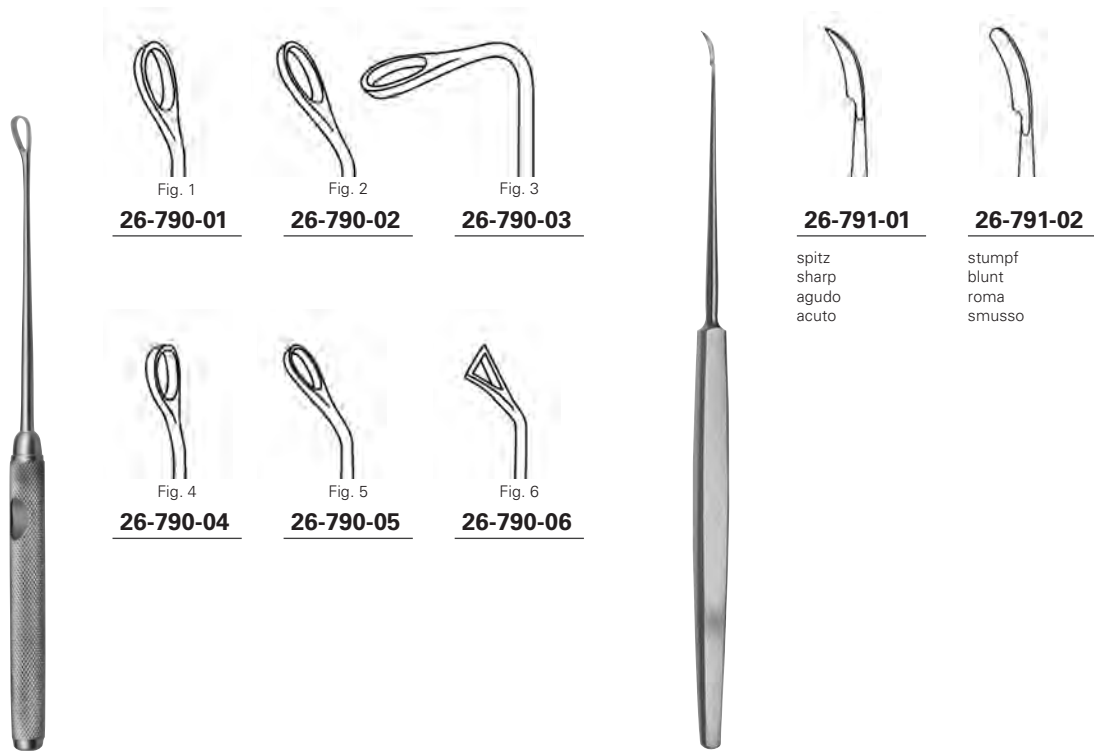


Fig. 1  
**26-790-01**

Fig. 2  
**26-790-02**

Fig. 3  
**26-790-03**

Fig. 4  
**26-790-04**

Fig. 5  
**26-790-05**

Fig. 6  
**26-790-06**

**26-791-01**  
spitz  
sharp  
agudo  
acuto

**26-791-02**  
stumpf  
blunt  
roma  
smusso

**COAKLEY**

**26-790-01 - 26-790-06** 17,0 cm, 6 3/4 "

**26-791-01 - 26-791-02** 19,0 cm, 7 1/2 "

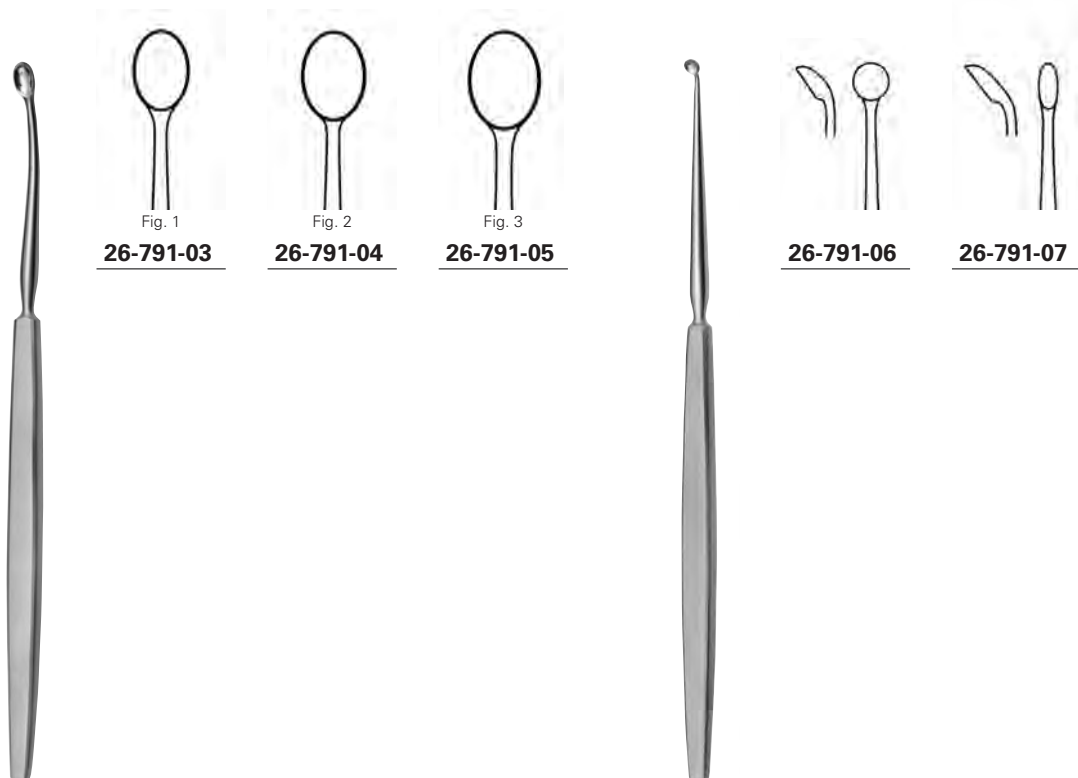


Fig. 1  
**26-791-03**

Fig. 2  
**26-791-04**

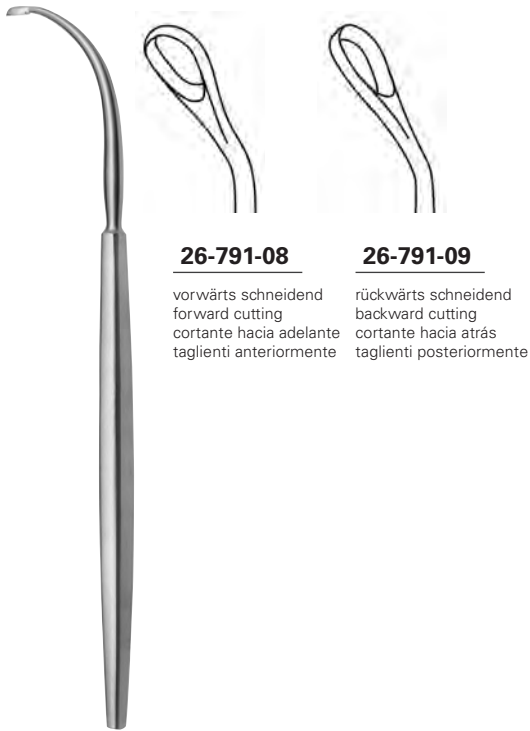
Fig. 3  
**26-791-05**

**26-791-06**

**26-791-07**

**26-791-03 - 26-791-05** 19,0 cm, 7 1/2 "

**26-791-06 - 26-791-07** 19,0 cm, 7 1/2 "

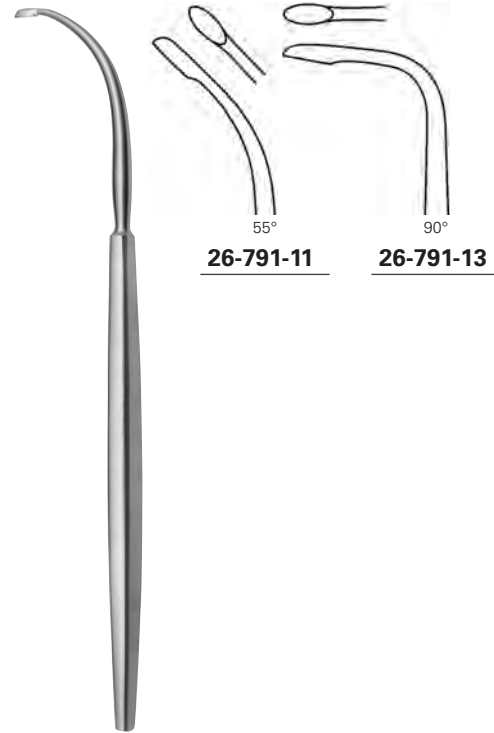


**26-791-08**

vorwärts schneidend  
 forward cutting  
 cortante hacia adelante  
 taglienti anteriormente

**26-791-09**

rückwärts schneidend  
 backward cutting  
 cortante hacia atrás  
 taglienti posteriormente



**26-791-11**

55°

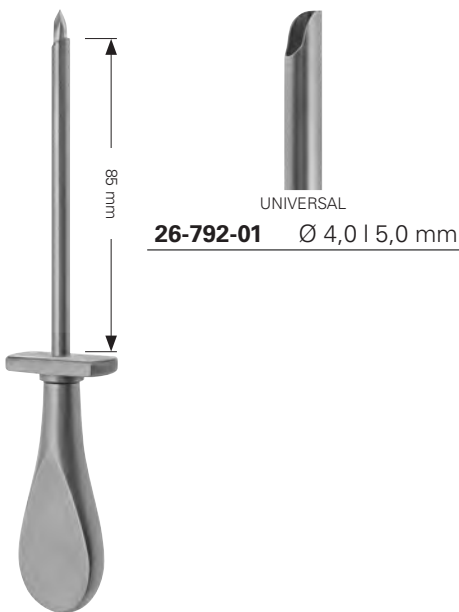
**26-791-13**

90°

**COAKLEY**

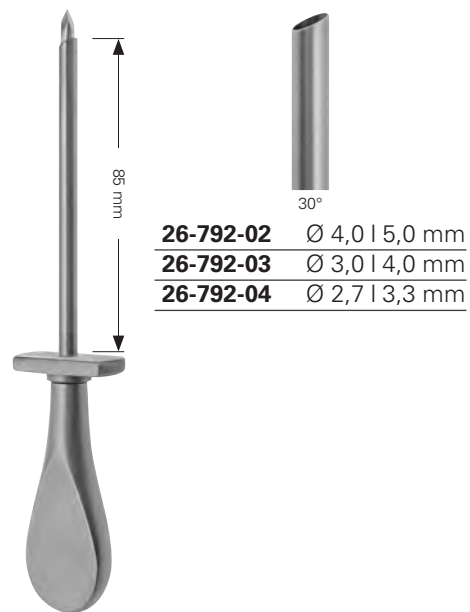
**26-791-08 - 26-791-09** 19,0 cm, 7 1/2"

**26-791-11 - 26-791-13** 19,0 cm, 7 1/2"



**26-792-01** Ø 4,0 | 5,0 mm

**26-792-01** 16,0 cm, 6 1/4"



**26-792-02** Ø 4,0 | 5,0 mm

**26-792-03** Ø 3,0 | 4,0 mm

**26-792-04** Ø 2,7 | 3,3 mm

**26-792-02 - 26-792-04** 16,0 cm, 6 1/4"

Kieferhöhlenraspeln, Antrumstanzen

Antrum rasps, Antrum punches

Escofina para el seno maxilar, Pinzas saca-bocados para el seno maxilar

Trapano per seno mascellare, Pinze taglianti per seno mascellare



**26-795-01**

mit Trokarspitze  
with trocar tip  
con punta de trocar  
con punta trequarti



**WIENER**

**26-795-01** 18,0 cm, 7"



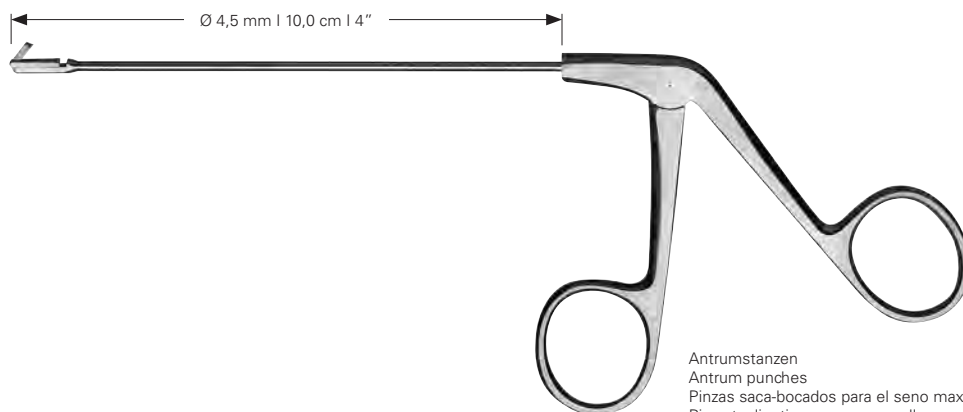
**26-795-02**

stumpf  
blunt  
roma  
smusso

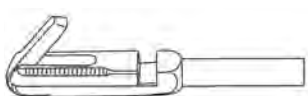


**WIENER**

**26-795-02** 18,0 cm, 7"

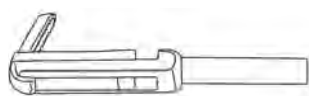


Antrumstanzen  
Antrum punches  
Pinzas saca-bocados para el seno maxilar  
Pinze taglianti per seno mascellare



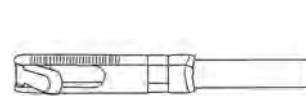
**26-794-00** 2,5 x 6,5 mm

nach oben schneidend  
cutting upwards  
corte hacia arriba  
taglio verso l'alto



**26-794-01** 2,5 x 6,5 mm

nach rechts schneidend  
cutting right  
corte hacia la derecha  
taglio a destra



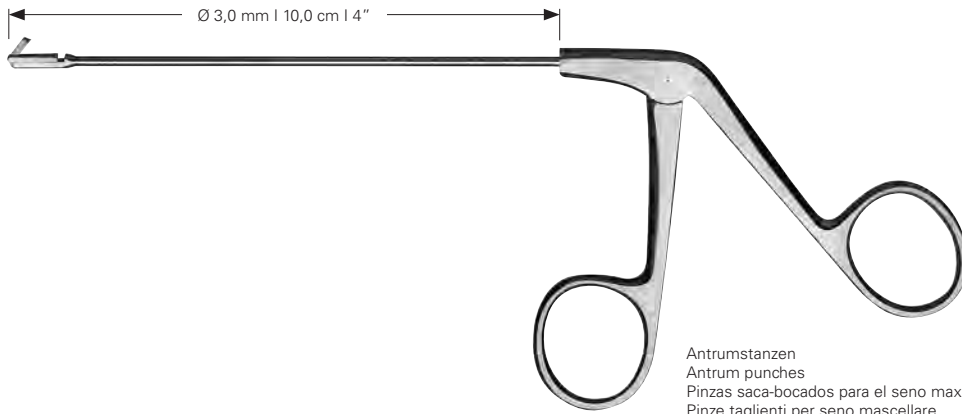
**26-794-02** 2,5 x 6,5 mm

nach links schneidend  
cutting left  
corte hacia a la izquierda  
taglio a sinistra

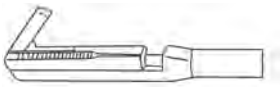


**26-794-03** 2,5 x 6,5 mm

nach unten schneidend  
cutting downwards  
corte hacia abajo  
taglio verso il basso



Antrumstanzen  
 Antrum punches  
 Pinzas saca-bocados para el seno maxilar  
 Pinze taglianti per seno mascellare



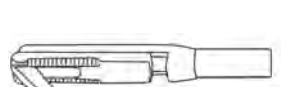
**26-794-10** 1,5 x 3,5 mm

nach oben schneidend  
 cutting upwards  
 corte hacia arriba  
 taglio verso l'alto



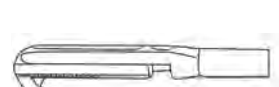
**26-794-11** 1,5 x 3,5 mm

nach rechts schneidend  
 cutting right  
 corte hacia la derecha  
 taglio a destra



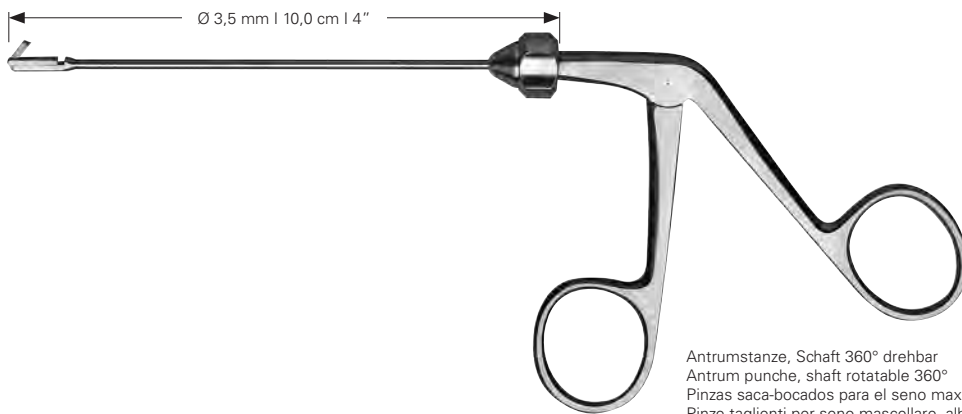
**26-794-12** 1,5 x 3,5 mm

nach links schneidend  
 cutting left  
 corte hacia a la izquierda  
 taglio a sinistra



**26-794-13** 1,5 x 3,5 mm

nach unten schneidend  
 cutting downwards  
 corte hacia abajo  
 taglio verso il basso



Antrumstanze, Schaft 360° drehbar  
 Antrum punche, shaft rotatable 360°  
 Pinzas saca-bocados para el seno maxilar, vástago girable 360°  
 Pinze taglianti per seno mascellare, albero rotante 360°



**26-796-00** 2,0 x 5,0 mm

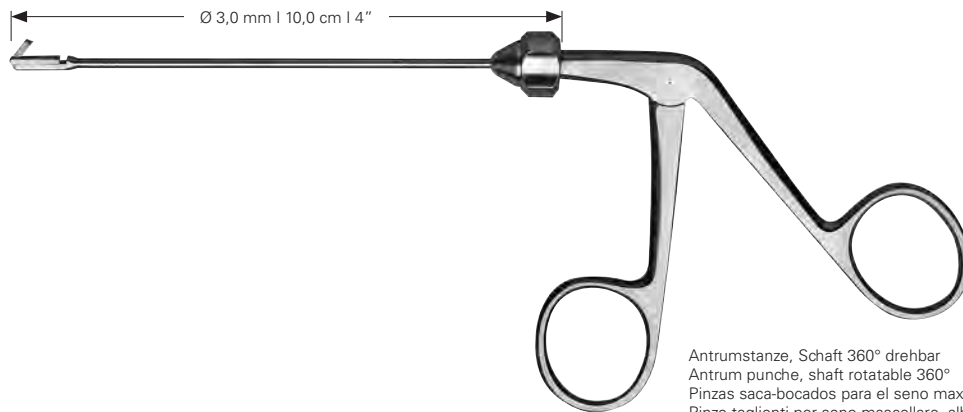
rückwärts schneidend  
 cutting retrograde  
 corte retrógrado  
 taglianti retrograda



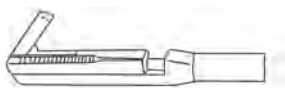
Antrumstanzen, Stirnhöhlenstanzen  
Antrum punches, Frontal sinus punches

Pinzas saca-bocados para el seno maxilar, Pinzas para el seno frontal

Pinze taglianti per seno mascellare, Pinze per seno frontale

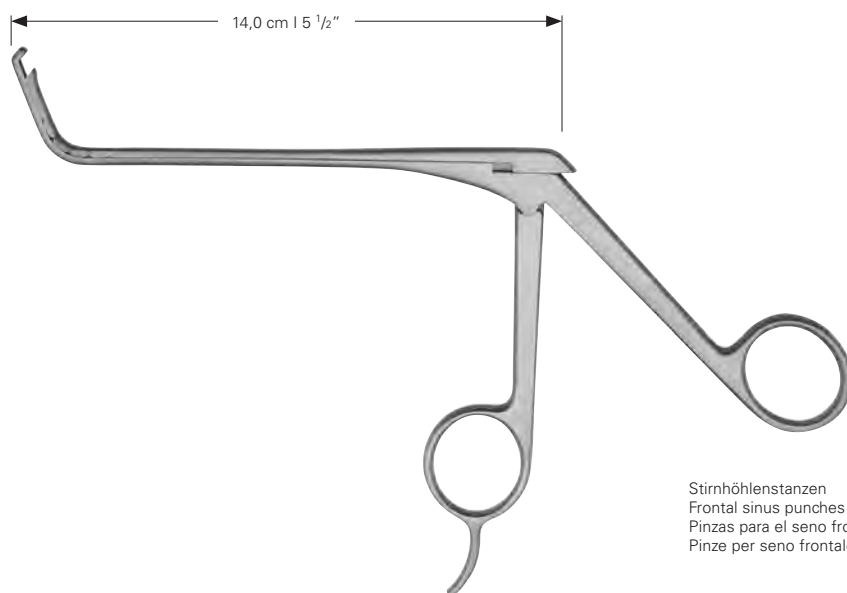


Antrumstanze, Schaft 360° drehbar  
Antrum punche, shaft rotatable 360°  
Pinzas saca-bocados para el seno maxilar, vástago girable 360°  
Pinze taglianti per seno mascellare, albero rotante 360°



**26-796-10** 1,5 x 3,5 mm

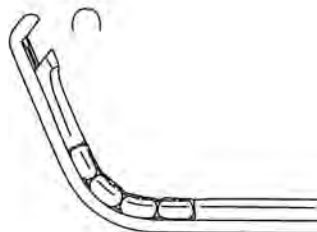
rückwärts schneidend  
cutting retrograde  
corte retrógrado  
taglianti retrograda



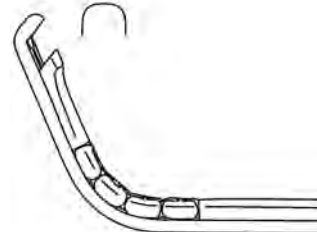
Stirnhöhlenstanzen  
Frontal sinus punches  
Pinzas para el seno frontal  
Pinze per seno frontale



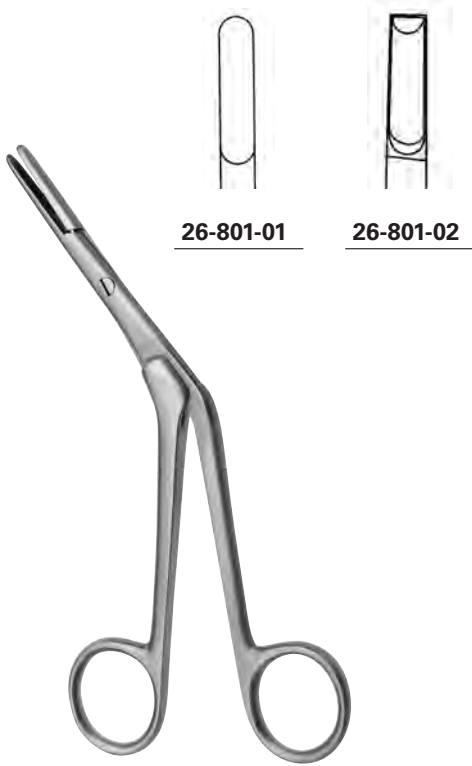
**26-798-02** 2,0 x 2,5 mm



**26-798-03** 3,0 x 3,5 mm



**26-798-05** 5,0 x 5,5 mm

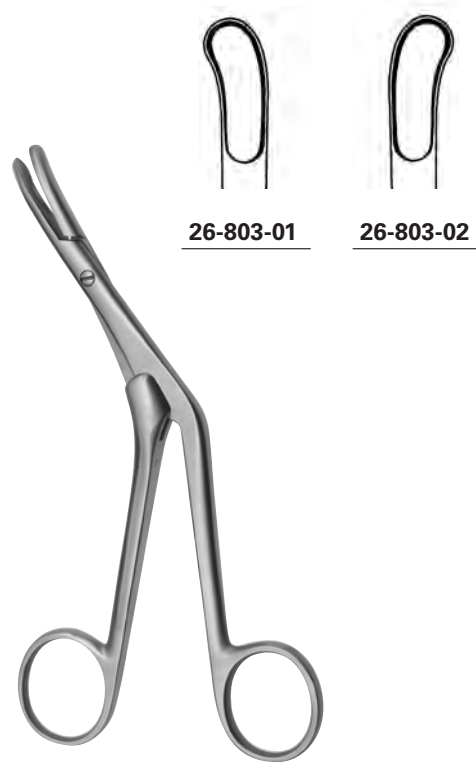


**26-801-01**

**26-801-02**

**CRAIG**

**26-801-01 - 26-801-02** 16,5 cm, 6 ½"



**26-803-01**

**26-803-02**

**CRAIG**

**26-803-01 - 26-803-02** 16,5 cm, 6 ½"

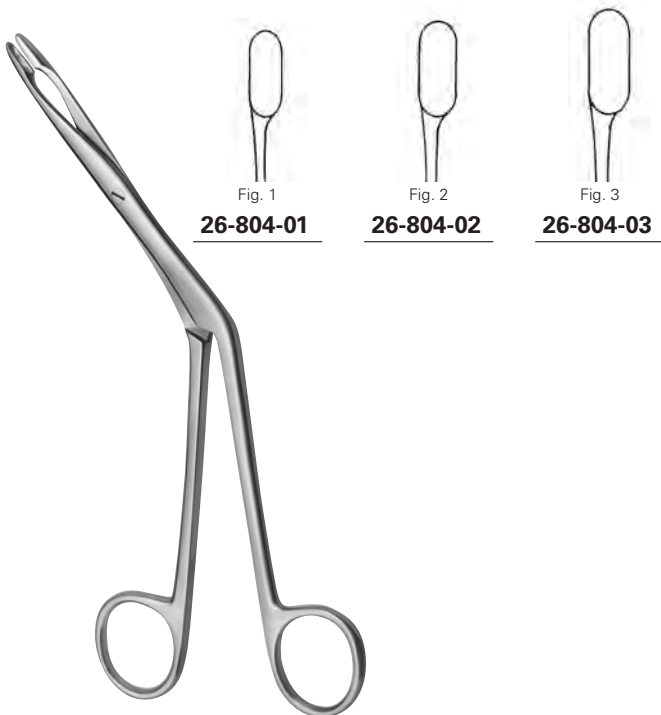


Fig. 1

**26-804-01**

Fig. 2

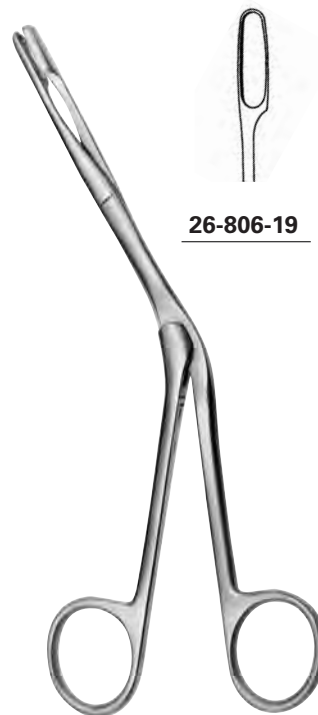
**26-804-02**

Fig. 3

**26-804-03**

**HEYMANN**

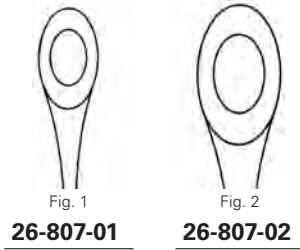
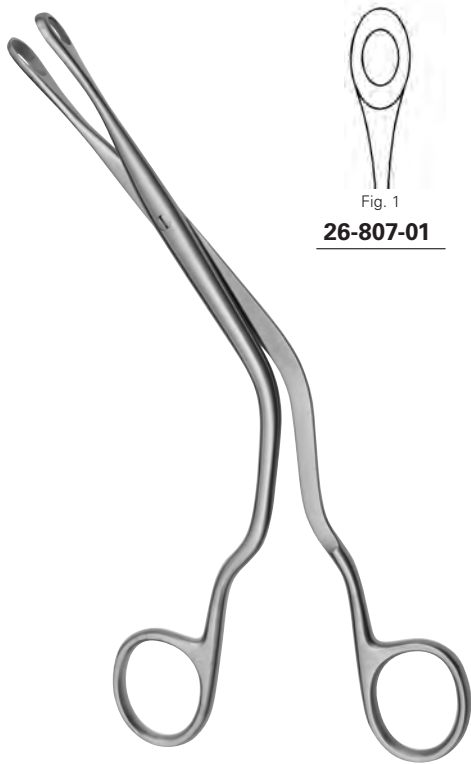
**26-804-01 - 26-804-03** 18,0 cm, 7"



**26-806-19**

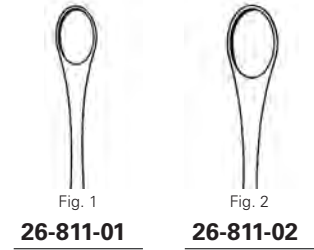
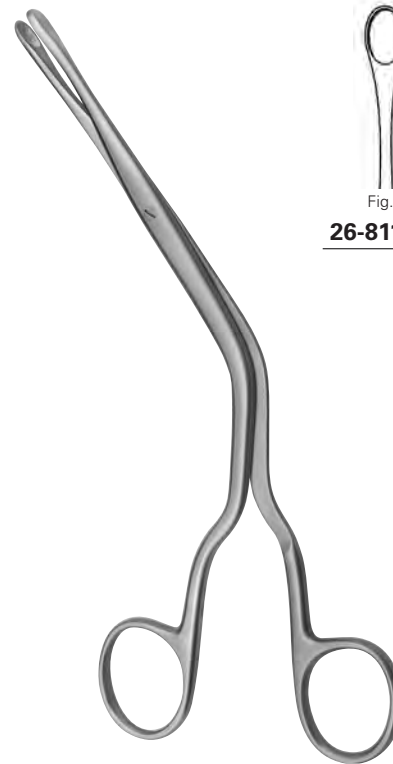
**KNIGHT**

**26-806-19** 18,0 cm, 7"



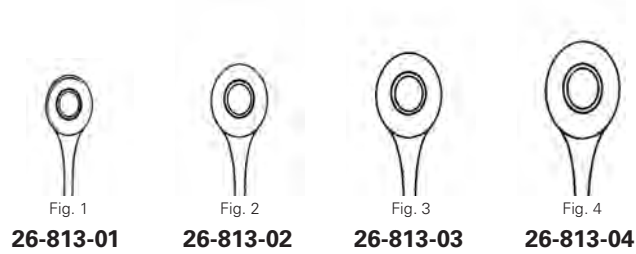
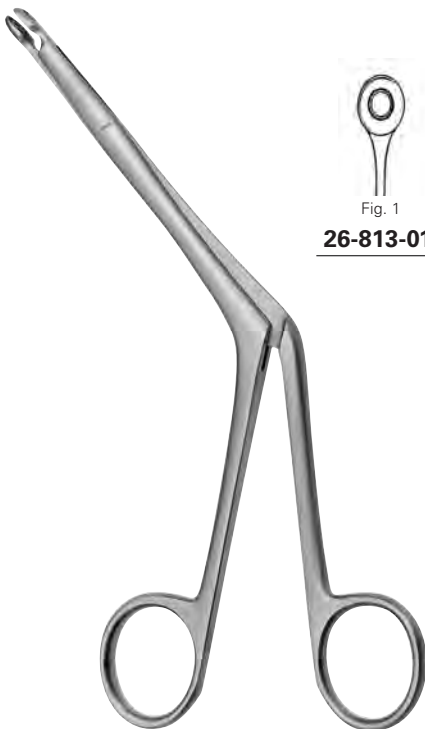
**LUC**

**26-807-01 - 26-807-02** 20,0 cm, 8"



**LUC**

**26-811-01 - 26-811-02** 20,0 cm, 8"



**BRUENINGS**

**26-813-01 - 26-813-04** 19,0 cm, 7 1/2"



**26-818-17** 17,0 cm, 6 <sup>3</sup>/<sub>4</sub> "



**BOIES**

**26-820-18** 18,0 cm, 7 "



**GOLDMANN**

**26-822-20** 20,0 cm, 8 "



**ASH**

**26-825-22** 23,0 cm, 9 "



**COTTLE-WALSHAM**

**26-826-01 - 26-826-03** 23,0 cm, 9 "

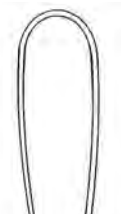


Fig. 1

**26-826-01**

gerade  
straight  
recta  
retto



Fig. 2

**26-826-02**

links  
left  
izquierda  
sinistra



Fig. 3

**26-826-03**

rechts  
right  
derecha  
destra



zerlegbar  
 dismantable  
 desmontable  
 smontabile

### COTTLE-WALSHAM

**26-828-22** 22,0 cm, 8 3/4"



3,0 mm

**26-829-03**



4,0 mm

**26-829-04**

### KRESSNER

**26-829-03 - 26-829-04** 22,0 cm, 8 3/4"



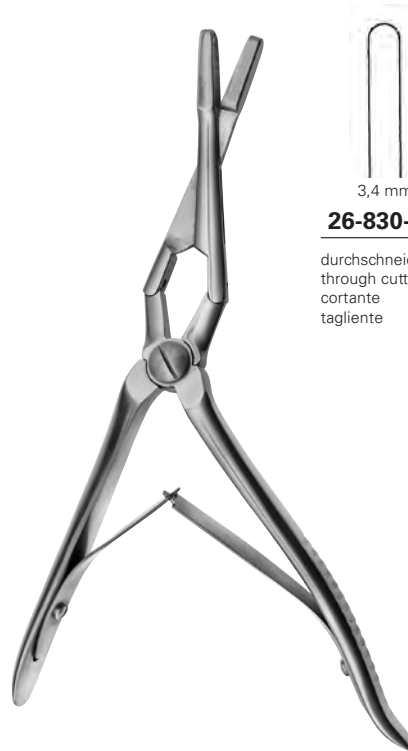
4,0 mm

**26-830-01**

aufeinanderschneidend  
 spoon shaped jaws  
 bocas cortantes  
 taglio a filo

### MIDDLETON-JANSEN

**26-830-01** 20,0 cm, 8"



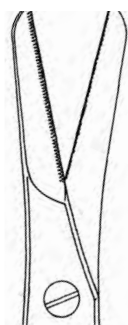
3,4 mm

**26-830-02**

durchschneidend  
 through cutting  
 cortante  
 tagliante

### MIDDLETON-JANSEN

**26-830-02** 19,0 cm, 7 1/2"

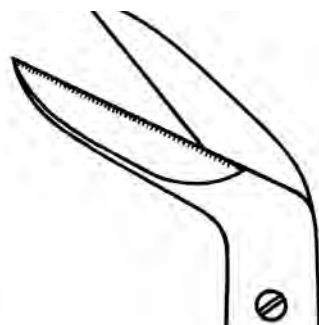


**26-841-20**



**CAPLAN**

**26-841-20** 20,0 cm, 8"



**26-843-21**



**KILLIAN**

**26-843-21** 20,0 cm, 8"



**26-845-21**



**26-845-99**

**RUBIN**

**26-845-21** 21,0 cm, 8 ¼"



23 x 31 mm

**26-846-19**

**GELFOAM**

**26-846-19** 19,0 cm, 7 ½"



**26-848-20**

**26-848-20** 20,0 cm, 8"



**CUSHING-LANDOLT**

- 26-900-01**    Ø 15 x 70 mm
- 26-900-02**    Ø 15 x 90 mm
- 26-900-03**    Ø 15 x 110 mm



Spreizzange für Spekulas 26-900-01 - 26-900-03  
 Spreading forceps for speculas 26-900-01 - 26-900-03  
 Pinza retractor para espéculos 26-900-01 - 26-900-03  
 Pinza divaricatore per speculum 26-900-01 - 26-900-03

**LANDOLT**

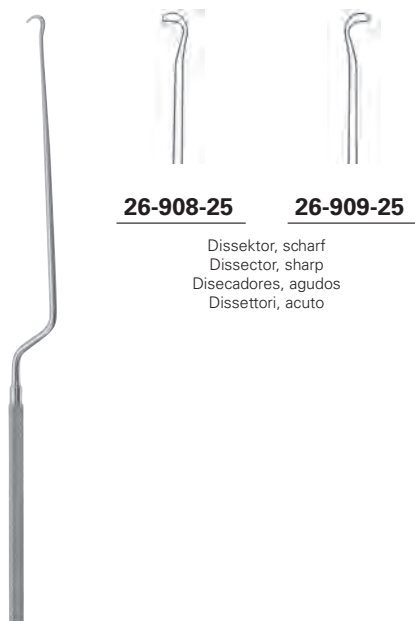
- 26-900-21**    21,0 cm, 8 ¼"



**PAPAVERO-CASPAR**

- 26-902-01**    Ø 11 x 80 mm
- 26-902-02**    Ø 13 x 90 mm
- 26-902-03**    Ø 15 x 100 mm

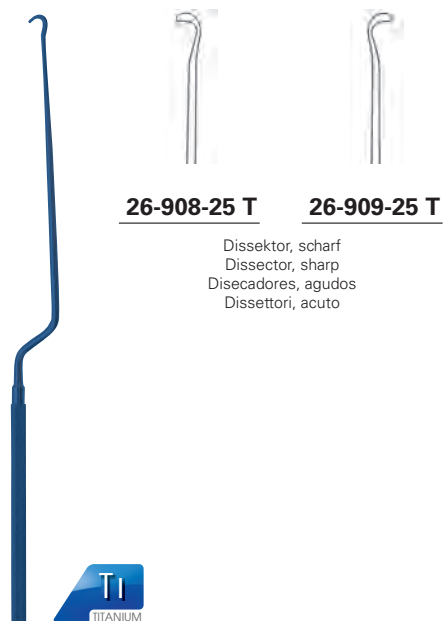




**26-908-25**

**26-909-25**

Dissektor, scharf  
 Dissector, sharp  
 Disecadores, agudos  
 Dissettori, acuto



**26-908-25 T**

**26-909-25 T**

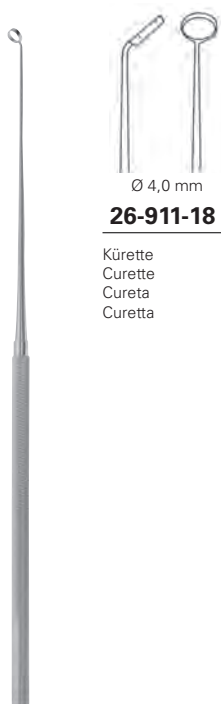
Dissektor, scharf  
 Dissector, sharp  
 Disecadores, agudos  
 Dissettori, acuto

**HARDY-FAHLBUSCH**

**26-908-25 - 26-909-25** 24,5 cm, 9 2/3 "

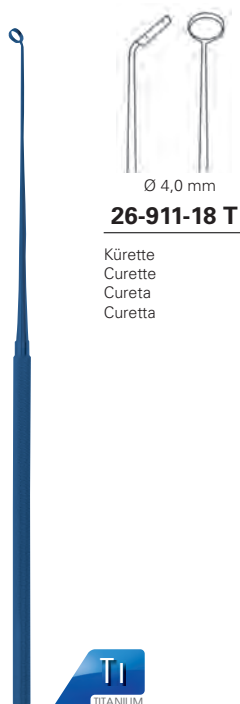
**HARDY-FAHLBUSCH**

**26-908-25 T - 26-909-25 T** 24,5 cm, 9 2/3 "



**26-911-18**

Kürette  
 Curette  
 Cureta  
 Curetta



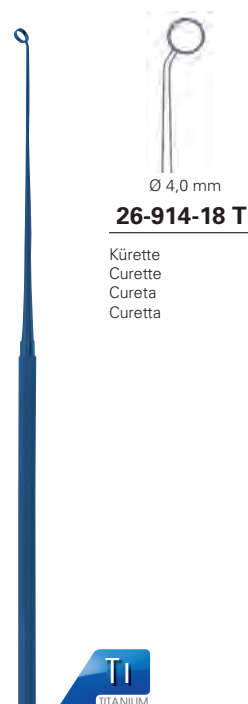
**26-911-18 T**

Kürette  
 Curette  
 Cureta  
 Curetta



**26-914-18**

Kürette  
 Curette  
 Cureta  
 Curetta



**26-914-18 T**

Kürette  
 Curette  
 Cureta  
 Curetta

**RAY**

**26-911-18** 18,0 cm, 7 "

**RAY**

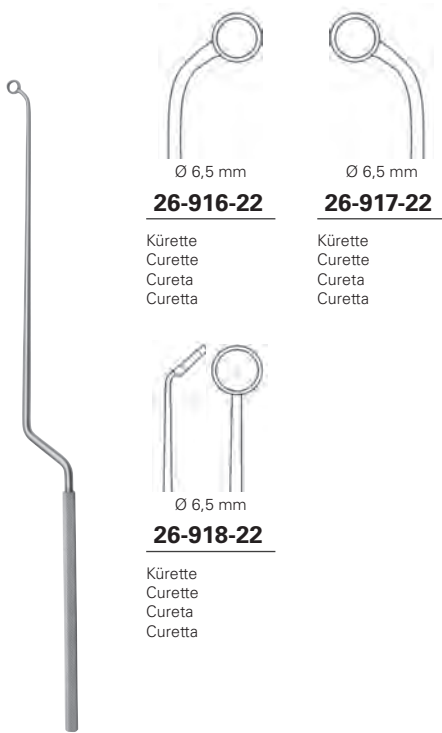
**26-911-18 T** 18,0 cm, 7 "

**RAY**

**26-914-18** 18,0 cm, 7 "

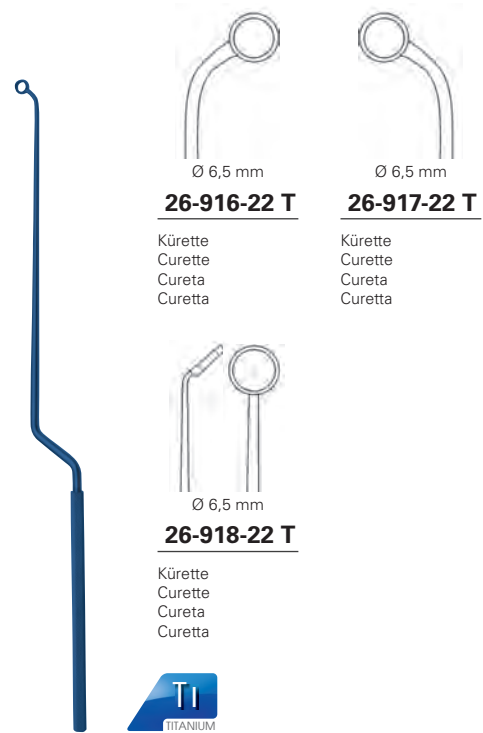
**RAY**

**26-914-18 T** 18,0 cm, 7 "



**NICOLA**

**26-916-22 - 26-918-22** 26,0 cm, 10 ¼ "



**NICOLA**

**26-916-22 T - 26-918-22 T** 26,0 cm, 10 ¼ "



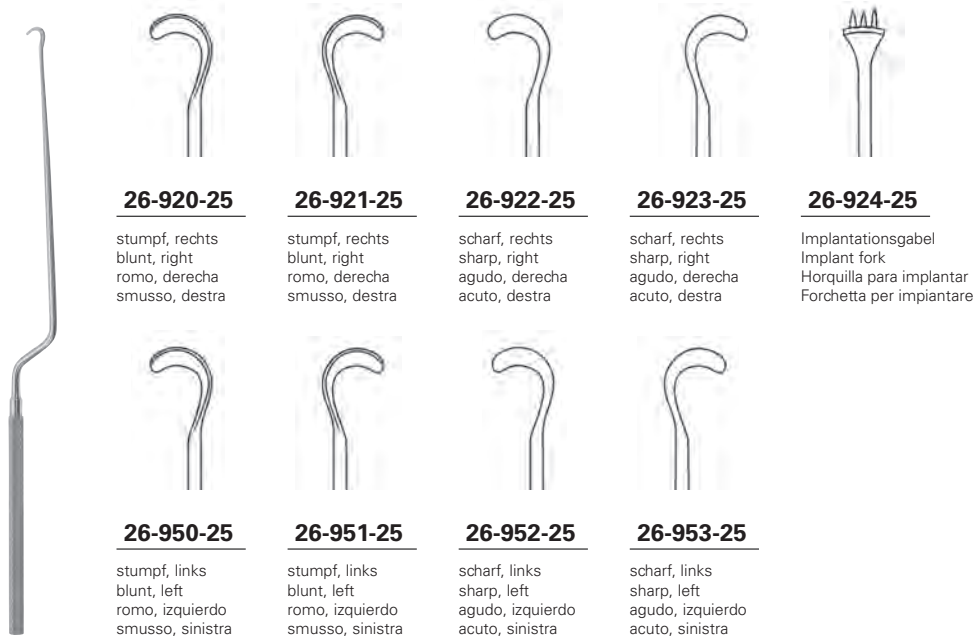
**NICOLA**

**26-919-22** 21,5 cm, 8 ½ "



**NICOLA**

**26-919-22 T** 21,5 cm, 8 ½ "



**26-920-25**

stumpf, rechts  
 blunt, right  
 romo, derecha  
 smusso, destra

**26-921-25**

stumpf, rechts  
 blunt, right  
 romo, derecha  
 smusso, destra

**26-922-25**

scharf, rechts  
 sharp, right  
 agudo, derecha  
 acuto, destra

**26-923-25**

scharf, rechts  
 sharp, right  
 agudo, derecha  
 acuto, destra

**26-924-25**

Implantationsgabel  
 Implant fork  
 Horquilla para implantar  
 Forchetta per impiantare

**26-950-25**

stumpf, links  
 blunt, left  
 romo, izquierdo  
 smusso, sinistra

**26-951-25**

stumpf, links  
 blunt, left  
 romo, izquierdo  
 smusso, sinistra

**26-952-25**

scharf, links  
 sharp, left  
 agudo, izquierdo  
 acuto, sinistra

**26-953-25**

scharf, links  
 sharp, left  
 agudo, izquierdo  
 acuto, sinistra

## HARDY

**26-920-25 - 26-953-25** 24,5 cm, 9 2/3 "



**26-920-25 T**

stumpf, rechts  
 blunt, right  
 romo, derecha  
 smusso, destra

**26-921-25 T**

stumpf, rechts  
 blunt, right  
 romo, derecha  
 smusso, destra

**26-922-25 T**

scharf, rechts  
 sharp, right  
 agudo, derecha  
 acuto, destra

**26-923-25 T**

scharf, rechts  
 sharp, right  
 agudo, derecha  
 acuto, destra

**26-950-25 T**

stumpf, links  
 blunt, left  
 romo, izquierdo  
 smusso, sinistra

**26-951-25 T**

stumpf, links  
 blunt, left  
 romo, izquierdo  
 smusso, sinistra

**26-952-25 T**

scharf, links  
 sharp, left  
 agudo, izquierdo  
 acuto, sinistra

**26-953-25 T**

scharf, links  
 sharp, left  
 agudo, izquierdo  
 acuto, sinistra

## HARDY

**26-920-25 T - 26-953-25 T** 24,5 cm, 9 2/3 "



**26-925-25**

stumpf, rechts  
blunt, right  
romo, derecha  
smusso, destra



**26-926-25**

stumpf, rechts  
blunt, right  
romo, derecha  
smusso, destra



**26-955-25**

stumpf, links  
blunt, left  
romo, izquierdo  
smusso, sinistra



**26-956-25**

stumpf, links  
blunt, left  
romo, izquierdo  
smusso, sinistra



**26-930-26**



**26-927-26**

Kürette  
Curette  
Cureta  
Curetta



Löffel  
Curette  
Cucharilla  
Curetta



**26-929-26**

Häkchen  
Hook  
Gancho  
Uncini

biegsam  
malleable  
maleable  
malleabile



**LANDOLT**

**26-925-25 - 26-956-25** 26,0 cm, 10 1/4 "

**HASOBUCCHI**

**26-930-26** 26,0 cm, 10 1/4 "



**26-925-25 T**

stumpf, rechts  
blunt, right  
romo, derecha  
smusso, destra



**26-926-25 T**

stumpf, rechts  
blunt, right  
romo, derecha  
smusso, destra



**26-955-25 T**

stumpf, links  
blunt, left  
romo, izquierdo  
smusso, sinistra



**26-956-25 T**

stumpf, links  
blunt, left  
romo, izquierdo  
smusso, sinistra



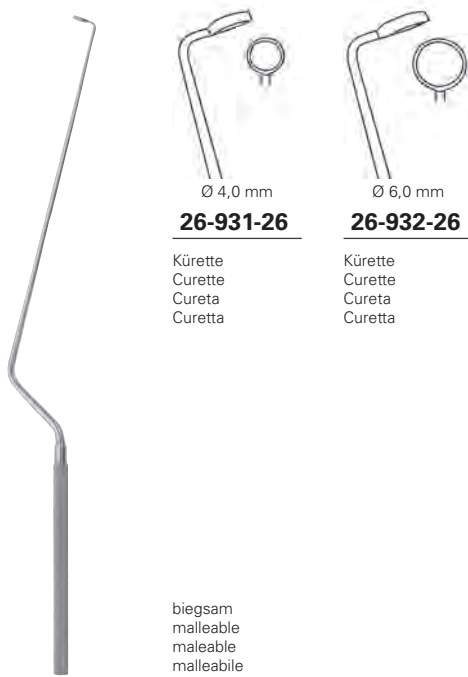
**26-929-26 T**

Häkchen  
Hook  
Gancho  
Uncini



**LANDOLT**

**26-925-25 T - 26-956-25 T** 26,0 cm, 10 1/4 "



Ø 4,0 mm  
**26-931-26**

Kürette  
 Curette  
 Cureta  
 Curetta

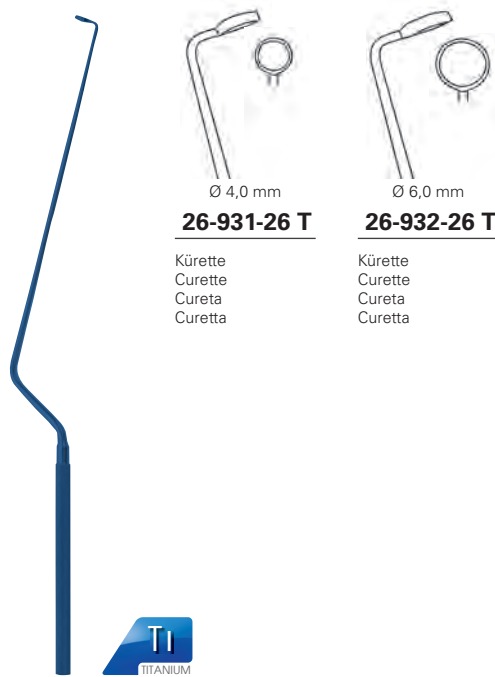
Ø 6,0 mm  
**26-932-26**

Kürette  
 Curette  
 Cureta  
 Curetta

biegsam  
 malleable  
 maleabile

### HARDY

**26-931-26 - 26-932-26** 26,0 cm, 10 ¼ "



Ø 4,0 mm  
**26-931-26 T**

Kürette  
 Curette  
 Cureta  
 Curetta

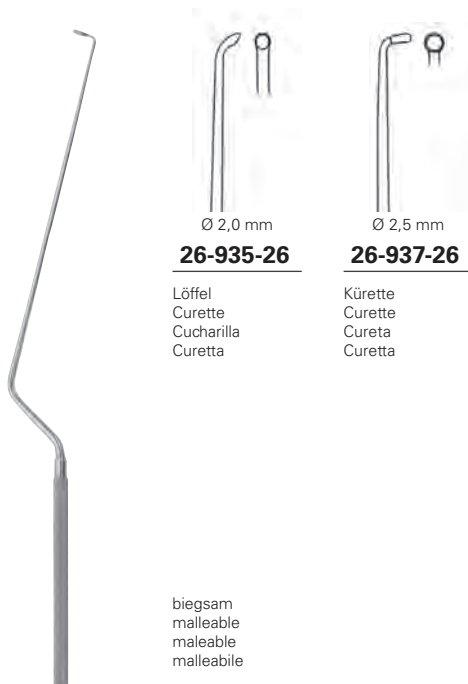
Ø 6,0 mm  
**26-932-26 T**

Kürette  
 Curette  
 Cureta  
 Curetta



### HARDY

**26-931-26 T - 26-932-26 T** 26,0 cm, 10 ¼ "



Ø 2,0 mm  
**26-935-26**

Löffel  
 Curette  
 Cucharilla  
 Curetta

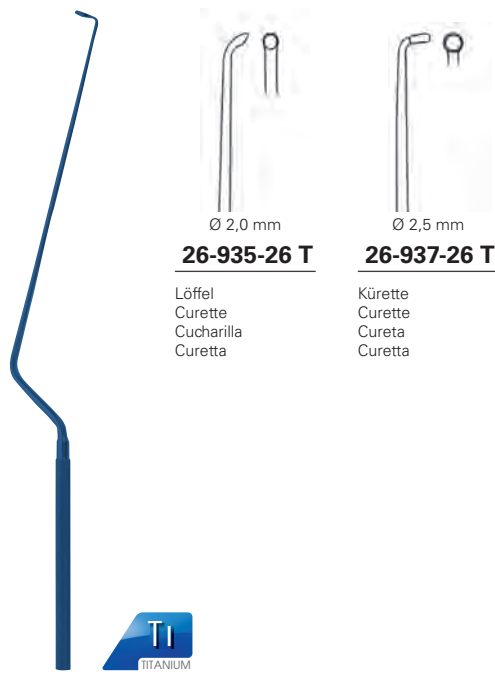
Ø 2,5 mm  
**26-937-26**

Kürette  
 Curette  
 Cureta  
 Curetta

biegsam  
 malleable  
 maleabile

### FAHLBUSCH

**26-935-26 - 26-937-26** 26,0 cm, 10 ¼ "



Ø 2,0 mm  
**26-935-26 T**

Löffel  
 Curette  
 Cucharilla  
 Curetta

Ø 2,5 mm  
**26-937-26 T**

Kürette  
 Curette  
 Cureta  
 Curetta



### FAHLBUSCH

**26-935-26 T - 26-937-26 T** 26,0 cm, 10 ¼ "



Ø 2,2 mm

**26-940-26**

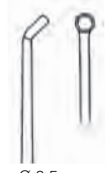
Raspatorium  
Raspatory  
Legra  
Periostotomo



Ø 3,2 mm

**26-941-26**

Raspatorium  
Raspatory  
Legra  
Periostotomo



Ø 2,5 mm

**26-942-26**

Kürette  
Curette  
Cureta  
Curetta



Ø 1,7 mm

**26-943-26**

Häkchen  
Hook  
Gancho  
Uncini



Ø 2,0 mm

**26-944-26**

Dissektor  
Dissector  
Disecadores  
Dissettori

## LANDOLT-REULEN

**26-940-26 - 26-944-26** 26,0 cm, 10 ¼ "



Ø 2,2 mm

**26-940-26 T**

Raspatorium  
Raspatory  
Legra  
Periostotomo



Ø 3,2 mm

**26-941-26 T**

Raspatorium  
Raspatory  
Legra  
Periostotomo



Ø 2,5 mm

**26-942-26 T**

Kürette  
Curette  
Cureta  
Curetta



Ø 1,7 mm

**26-943-26 T**

Häkchen  
Hook  
Gancho  
Uncini



Ø 2,0 mm

**26-944-26 T**

Dissektor  
Dissector  
Disecadores  
Dissettori



## LANDOLT-REULEN

**26-940-26 T - 26-944-26 T** 26,0 cm, 10 ¼ "



# 27

HNO-Instrumente

ENT Instruments

Instrumentos para ORL

Strumenti per ORL









# 27

Mikro Instrumente  
Micro Instruments  
Instrumentos de micro  
Strumentario micro





**72**

Endoskope

Endoscopes

Endoscopios

Endoscopi





mit Dämpfer  
with clamp  
con sordina  
con sordina



mit Fuß  
with foot  
con pie  
con pie

### HARTMANN (FRENCH)

<b>27-000-01</b>	C <sub>2</sub>	16 Hz
<b>27-000-02</b>	C <sub>1</sub>	32 Hz
<b>27-000-03</b>	C	64 Hz
<b>27-000-04</b>	c	128 Hz
<b>27-000-05</b>	c <sup>1</sup>	256 Hz

### HARTMANN

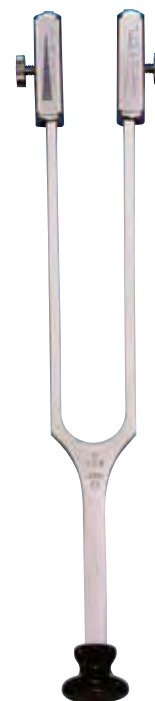
<b>27-001-01</b>	c	128 Hz
<b>27-001-02</b>	c <sup>1</sup>	256 Hz
<b>27-001-03</b>	c <sup>2</sup>	512 Hz
<b>27-001-04</b>	c <sup>3</sup>	1024 Hz
<b>27-001-05</b>	c <sup>4</sup>	2048 Hz
<b>27-001-06</b>	c <sup>5</sup>	4096 Hz

### LUCAE

<b>27-004-01</b>	c	128 Hz
<b>27-004-02</b>	c <sup>1</sup>	256 Hz
<b>27-004-03</b>	c <sup>2</sup>	512 Hz
<b>27-004-04</b>	c <sup>3</sup>	1024 Hz
<b>27-004-05</b>	c <sup>4</sup>	2048 Hz
<b>27-004-06</b>	c <sup>5</sup>	4096 Hz



mit Dämpfer  
with clamp  
con sordina  
con sordina



mit Dämpfer C 64 Hz  
ohne Dämpfer c 128 Hz  
with clamp C 64 Hz  
without clamp c 128 Hz  
con sordina C 64 Hz  
sin sordina 128 Hz  
con sordina C 64 Hz  
senza sordina 128 Hz

<b>27-005-01</b>	c	64 Hz
<b>27-005-02</b>	c	128 Hz
<b>27-005-03</b>	c <sup>1</sup>	256 Hz

<b>27-005-04</b>	c <sup>2</sup>	512 Hz
<b>27-005-05</b>	c <sup>3</sup>	1024 Hz
<b>27-005-06</b>	c <sup>4</sup>	2048 Hz
<b>27-005-07</b>	c <sup>5</sup>	4096 Hz

### RYDEL-SEIFFER

**27-008-01**

einstellbar bis **h 240 Hz**  
adjustable up to **h 240 Hz**  
ajustable hasta **h 240 Hz**  
regolabili fino ad **h 240 Hz**



mit Fuß  
with foot  
con pie  
con pie

**27-010-01** a<sup>1</sup> 440 Hz



mit Fuß  
with foot  
con pie  
con pie

**LUCAE**

**27-012-01** c 128 Hz

einstellbar bis **h 240 Hz**  
adjustable up to **h 240 Hz**  
ajustable hasta **h 240 Hz**  
regolabili fino ad **h 240 Hz**



**HARTMANN**

**27-013-01** c 128 Hz

einstellbar bis **g 194 Hz**  
adjustable up to **g 194 Hz**  
ajustable hasta **g 194 Hz**  
regolabili fino ad **g 194 Hz**



mit Fuß  
with foot  
con pie  
con pie

**KOENIG**

**27-015-01** A 109 Hz



Stimmgabel für neurologische Untersuchungen, mit Reflexhammer, Nadelrad, Pinsel und Nadel

Tuning fork for neurological examinations, with percussion hammer, pin wheel, brush and needle

Diapason para exámenes neurologicos, con martillo para reflejo, rueda de agujas, pincel y aguja

Diapason per esami neurologici, con martello di riflesso, ruota (ingranaggio) per l'ago, pennello ed ago

**27-018-00** c 275 Hz



### **27-005-00** SET

komplett, bestehend aus: 27-005-02, -03, -04, -05, -06  
complete, consisting of: 27-005-02, -03, -04, -05, -06  
completo, compuesto de: 27-005-02, -03, -04, -05, -06  
completo, composto da: 27-005-02, -03, -04, -05, -06

## **HARTMANN**

### **27-007-00** SET

komplett, bestehend aus: 27-001-03, 27-001-04, 27-001-05, 27-000-04, 27-000-05  
complete, consisting of: 27-001-03, 27-001-04, 27-001-05, 27-000-04, 27-000-05  
completo, compuesto de: 27-001-03, 27-001-04, 27-001-05, 27-000-04, 27-000-05  
completo, composto da: 27-001-03, 27-001-04, 27-001-05, 27-000-04, 27-000-05

## **HARTMANN**

### **27-007-01** SET

komplett, bestehend aus: 27-001-03, 27-001-04, 27-001-05, 27-001-06, 27-000-04, 27-000-05  
complete, consisting of: 27-001-03, 27-001-04, 27-001-05, 27-001-06, 27-000-04, 27-000-05  
completo, compuesto de: 27-001-03, 27-001-04, 27-001-05, 27-001-06, 27-000-04, 27-000-05  
completo, composto da: 27-001-03, 27-001-04, 27-001-05, 27-001-06, 27-000-04, 27-000-05

## **HARTMANN**

### **27-008-00** SET

komplett, bestehend aus: 27-001-03, 27-001-04, 27-001-05, 27-001-06, 27-000-02, 27-000-03, 27-000-04, 27-000-05  
complete, consisting of: 27-001-03, 27-001-04, 27-001-05, 27-001-06, 27-000-02, 27-000-03, 27-000-04, 27-000-05  
completo, compuesto de: 27-001-03, 27-001-04, 27-001-05, 27-001-06, 27-000-02, 27-000-03, 27-000-04, 27-000-05  
completo, composto da: 27-001-03, 27-001-04, 27-001-05, 27-001-06, 27-000-02, 27-000-03, 27-000-04, 27-000-05



Lärmtrommel mit Ohrolive  
Noise drum with ear olive  
Ensordecedor con oliva  
Tamburo rumoroso con oliva



**BARANY**

**27-020-00**



Fig. 0

**27-031-00**

Fig. 1

**27-031-01**

Fig. 2

**27-031-02**

Fig. 3

**27-031-03**

Fig. 4

**27-031-04**

Fig. 5

**27-031-05**

**HARTMANN**

**27-031-00 - 27-031-05** 15,0 cm, 6 "



**POLITZER**

**27-034-04** Ø 4,0 mm



**POLITZER**

**27-034-15** Ø 15,0 mm



**POLITZER**

**27-034-17** Ø 17,0 mm



**POLITZER**

**27-034-22** Ø 22,0 mm



**POLITZER**

**27-034-50**



**POLITZER**

**27-034-03**



## POLITZER

**27-034-00** SET

Komplett, bestehend aus:

1 Gummibirne	<b>27-034-50</b>
1 Einsteckkonus	<b>27-034-03</b>
1 Nasenolive, Ø 15,0 mm	<b>27-034-15</b>
1 Nasenolive, Ø 17,0 mm	<b>27-034-17</b>
1 Nasenolive, Ø 12,0 mm	<b>27-034-22</b>

Complete, consisting of:

1 Rubber bulb	<b>27-034-50</b>
1 Connecting nozzle	<b>27-034-03</b>
1 Nose olive, Ø 15,0 mm	<b>27-034-15</b>
1 Nose olive, Ø 17,0 mm	<b>27-034-17</b>
1 Nose olive, Ø 12,0 mm	<b>27-034-22</b>

Completo, compuesto de:

1 Pera de goma	<b>27-034-50</b>
1 Cono de conexión	<b>27-034-03</b>
1 Oliva nasal, Ø 15,0 mm	<b>27-034-15</b>
1 Oliva nasal, Ø 17,0 mm	<b>27-034-17</b>
1 Oliva nasal, Ø 12,0 mm	<b>27-034-22</b>

Completo, composto da:

1 Pera in gomma	<b>27-034-50</b>
1 Cono di connessione	<b>27-034-03</b>
1 Oliva nasale, Ø 15,0 mm	<b>27-034-15</b>
1 Oliva nasale, Ø 17,0 mm	<b>27-034-17</b>
1 Oliva nasale, Ø 12,0 mm	<b>27-034-22</b>



## POLITZER

**27-034-01** SET

Komplett, bestehend aus:

1 Gummibirne	<b>27-034-50</b>
1 Einsteckkonus	<b>27-034-03</b>
1 Ohrolive, Ø 4,0 mm	<b>27-034-04</b>
1 Nasenolive, Ø 15,0 mm	<b>27-034-15</b>
1 Nasenolive, Ø 17,0 mm	<b>27-034-17</b>
1 Nasenolive, Ø 12,0 mm	<b>27-034-22</b>

Complete, consisting of:

1 Rubber bulb	<b>27-034-50</b>
1 Connecting nozzle	<b>27-034-03</b>
1 Ear olive, Ø 4,0 mm	<b>27-034-04</b>
1 Nose olive, Ø 15,0 mm	<b>27-034-15</b>
1 Nose olive, Ø 17,0 mm	<b>27-034-17</b>
1 Nose olive, Ø 12,0 mm	<b>27-034-22</b>

Completo, compuesto de:

1 Pera de goma	<b>27-034-50</b>
1 Cono de conexión	<b>27-034-03</b>
1 Oliva auricular, Ø 4,0mm	<b>27-034-04</b>
1 Oliva nasal, Ø 15,0 mm	<b>27-034-15</b>
1 Oliva nasal, Ø 17,0 mm	<b>27-034-17</b>
1 Oliva nasal, Ø 12,0 mm	<b>27-034-22</b>

Completo, composto da:

1 Pera in gomma	<b>27-034-50</b>
1 Cono di connessione	<b>27-034-03</b>
1 Oliva auricolare, Ø4,0mm	<b>27-034-04</b>
1 Oliva nasale, Ø 15,0 mm	<b>27-034-15</b>
1 Oliva nasale, Ø 17,0 mm	<b>27-034-17</b>
1 Oliva nasale, Ø 12,0 mm	<b>27-034-22</b>



## POLITZER-ASEPTIC

**27-034-02** SET

Komplett, bestehend aus:

1 Kunststoffbox	
1 Gummibirne	<b>27-034-50</b>
1 Einsteckkonus	<b>27-034-03</b>
1 Ohrolive, Ø 4,0 mm	<b>27-034-04</b>
1 Nasenolive, Ø 15,0 mm	<b>27-034-15</b>
1 Nasenolive, Ø 17,0 mm	<b>27-034-17</b>
1 Nasenolive, Ø 12,0 mm	<b>27-034-22</b>

Complete, consisting of:

1 Plastic box	
1 Rubber bulb	<b>27-034-50</b>
1 Connecting nozzle	<b>27-034-03</b>
1 Ear olive, Ø 4,0 mm	<b>27-034-04</b>
1 Nose olive, Ø 15,0 mm	<b>27-034-15</b>
1 Nose olive, Ø 17,0 mm	<b>27-034-17</b>
1 Nose olive, Ø 12,0 mm	<b>27-034-22</b>

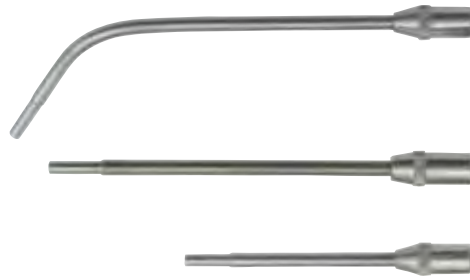
Completo, compuesto de:

1 Caja de plástico	
1 Pera de goma	<b>27-034-50</b>
1 Cono de conexión	<b>27-034-03</b>
1 Oliva auricular, Ø 4,0mm	<b>27-034-04</b>
1 Oliva nasal, Ø 15,0 mm	<b>27-034-15</b>
1 Oliva nasal, Ø 17,0 mm	<b>27-034-17</b>
1 Oliva nasal, Ø 12,0 mm	<b>27-034-22</b>

Completo, composto da:

1 Contenitori di plastica	
1 Pera in gomma	<b>27-034-50</b>
1 Cono di connessione	<b>27-034-03</b>
1 Oliva auricolare, Ø4,0mm	<b>27-034-04</b>
1 Oliva nasale, Ø 15,0 mm	<b>27-034-15</b>
1 Oliva nasale, Ø 17,0 mm	<b>27-034-17</b>
1 Oliva nasale, Ø 12,0 mm	<b>27-034-22</b>





**27-036-13** 130 mm

**27-036-11** 110 mm

**27-036-08** 80 mm

**KABIERSKE**

**27-036-00** SET

Komplett, bestehend aus:

Complete, consisting of:

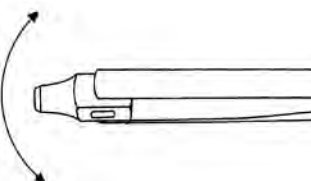
1 Ventilball	<b>27-036-50</b>	1 Valve rubber bulb	<b>27-036-50</b>
1 Flasche	<b>27-036-01</b>	1 Bottle	<b>27-036-01</b>
1 Ohrkanüle, 80 mm	<b>27-036-08</b>	1 Ear cannula, 80 mm	<b>27-036-08</b>
1 Ohrkanüle, 110 mm	<b>27-036-11</b>	1 Ear cannula, 110 mm	<b>27-036-11</b>
1 Ohrkanüle, 130 mm	<b>27-036-13</b>	1 Ear cannula, 130 mm	<b>27-036-13</b>
1 Pulverbläser	<b>27-036-40</b>	1 Atomizer	<b>27-036-40</b>



Completo, compuesto de:

Completo, composto da:

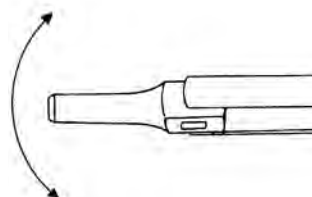
1 Pera de goma con valva	<b>27-036-50</b>	1 Pallone gomma con valva	<b>27-036-50</b>
1 Frasco	<b>27-036-01</b>	1 Bottiglia	<b>27-036-01</b>
1 Cánula auricular, 80 mm	<b>27-036-08</b>	1 Cannula auricolare 80mm	<b>27-036-08</b>
1 Cánula auricular, 110 mm	<b>27-036-11</b>	1 Cannula auricolare 110mm	<b>27-036-11</b>
1 Cánula auricular, 130 mm	<b>27-036-13</b>	1 Cannula auricolare 130mm	<b>27-036-13</b>
1 Pulverizador	<b>27-036-40</b>	1 Insuffiatore polvere	<b>27-036-40</b>



**UNIVERSAL**

**27-039-00**

für Rhinologie  
for Rhinology  
para Rinología  
per Rinologia



**UNIVERSAL**

**27-040-00**

für Otologie  
for Otology  
para Otológia  
per Otológia





komplett  
 complete  
 completo  
 completo

- 27-044-05** 50 ml
- 27-044-07** 75 ml
- 27-044-10** 100 ml
- 27-044-15** 150 ml



**27-041-11**



**27-041-12**



**27-041-13**



selbstfüllend in Kunststofftasche  
 self filling in plastic pouch  
 auto-rellena en bolsa plástica  
 auto-riempente in borsa di plastica

**27-042-00** 10 ml

komplett  
 complete  
 completo



Spritze  
 Syringe  
 Jeringa  
 Siringa

**27-042-01**



Schutzteller  
 Protecting disc  
 Disco protector  
 Disco protettivo

**27-042-05**



Saugansatz  
 Suction nozzle  
 Pieza de succión  
 Aspiratore

**27-042-04**



Verbindungsschlauch  
 Flexible tube  
 Tubo de conexión  
 Tubo di connessione

**27-042-03**



Ventilaufsatz  
 Valve attachment  
 Válvula de conexión  
 Valvola di connessione

**27-042-02**



Gewindeansatz  
 Threaded tip  
 Punta de rosca  
 Punta filettata

**27-042-09**



Geknöpfter Ansatz  
 Button end tip  
 Punta de botón  
 Punta a bottone

**27-042-08**



Konischer Ansatz  
 Conical tip  
 Punta cónica  
 Punta conica

**27-042-07**



Metallolive  
 Metal olive  
 Oliva metálica  
 Oliva in metallo

**27-042-06**

Fig. 1



4,5 x 5,5 mm

**27-101-01**

Fig. 2



5,5 x 6,5 mm

**27-101-02**

Fig. 3



6,5 x 7,5 mm

**27-101-03**

Fig. 4



7,5 x 8,5 mm

**27-101-04**

Fig. 5



8,5 x 9,5 mm

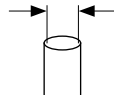
**27-101-05**

Fig. 6



9,5 x 10,5 mm

**27-101-06**



Innendurchmesser  
Inside diameter  
Diámetro interior  
Diámetro interno

## ZOELLNER

<b>27-101-01</b>	Fig. 1   38 mm
<b>27-101-02</b>	Fig. 2   38 mm
<b>27-101-03</b>	Fig. 3   38 mm
<b>27-101-04</b>	Fig. 4   38 mm
<b>27-101-05</b>	Fig. 5   38 mm
<b>27-101-06</b>	Fig. 6   38 mm

## ZOELLNER

<b>27-101-00</b>	Set
bestehend aus:	Fig. 1 - Fig. 6   (6 Stück)
consisting of:	Fig. 1 - Fig. 6   (6 pieces)
compuesto de:	Fig. 1 - Fig. 6   (6 piezas)
composto da:	Fig. 1 - Fig. 6   (6 pezzi)

## ZOELLNER

<b>27-101-50</b>	Set
bestehend aus:	Fig. 1 - Fig. 3   (3 Stück)
consisting of:	Fig. 1 - Fig. 3   (3 pieces)
compuesto de:	Fig. 1 - Fig. 3   (3 piezas)
composto da:	Fig. 1 - Fig. 3   (3 pezzi)

## ZOELLNER

<b>27-101-60</b>	Set
bestehend aus:	Fig. 4 - Fig. 6   (3 Stück)
consisting of:	Fig. 4 - Fig. 6   (3 pieces)
compuesto de:	Fig. 4 - Fig. 6   (3 piezas)
composto da:	Fig. 4 - Fig. 6   (3 pezzi)

Fig. 1



3,3 mm

**27-102-01**

Fig. 2



4,3 mm

**27-102-02**

Fig. 3



4,8 mm

**27-102-03**

Fig. 4



5,3 mm

**27-102-04**

Fig. 5



5,8 mm

**27-102-05**

Fig. 6



6,3 mm

**27-102-06**

Fig. 7



6,7 mm

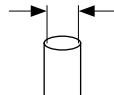
**27-102-07**

Fig. 8



7,2 mm

**27-102-08**



Innendurchmesser  
Inside diameter  
Diámetro interior  
Diámetro interno

Fig. 9



7,7 mm

**27-102-09**

## FARRIOR

<b>27-102-01</b>	Fig. 1   43 mm
<b>27-102-02</b>	Fig. 2   43 mm
<b>27-102-03</b>	Fig. 3   43 mm
<b>27-102-04</b>	Fig. 4   43 mm
<b>27-102-05</b>	Fig. 5   43 mm
<b>27-102-06</b>	Fig. 6   43 mm
<b>27-102-07</b>	Fig. 7   43 mm
<b>27-102-08</b>	Fig. 8   43 mm
<b>27-102-09</b>	Fig. 9   43 mm

## FARRIOR

<b>27-102-00</b>	Set
bestehend aus:	Fig. 1 - Fig. 9   (9 Stück)
consisting of:	Fig. 1 - Fig. 9   (9 pieces)
compuesto de:	Fig. 1 - Fig. 9   (9 piezas)
composto da:	Fig. 1 - Fig. 9   (9 pezzi)



Fig. 1



2,0 mm

**27-103-02**

Fig. 2



3,0 mm

**27-103-03**

Fig. 3



4,0 mm

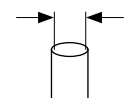
**27-103-04**

Fig. 4



5,0 mm

**27-103-05**



Innendurchmesser  
Inside diameter  
Diámetro interior  
Diámetro interno

## POLITZER

**27-103-02** Fig. 1 | 27 mm

**27-103-03** Fig. 2 | 27 mm

**27-103-04** Fig. 3 | 27 mm

**27-103-05** Fig. 4 | 27 mm

## POLITZER

**27-103-00** Set

bestehend aus: Fig. 1 - Fig. 3 | (3 Stück)  
consisting of: Fig. 1 - Fig. 3 | (3 pieces)  
compuesto de: Fig. 1 - Fig. 3 | (3 piezas)  
composto da: Fig. 1 - Fig. 3 | (3 pezzi)

## POLITZER

**27-103-01** Set

bestehend aus: Fig. 1 - Fig. 4 | (4 Stück)  
consisting of: Fig. 1 - Fig. 4 | (4 pieces)  
compuesto de: Fig. 1 - Fig. 4 | (4 piezas)  
composto da: Fig. 1 - Fig. 4 | (4 pezzi)

Fig. 1



1,7 mm

**27-103-18**

Fig. 2



3,2 mm

**27-103-32**

Fig. 3



4,7 mm

**27-103-46**

Fig. 1



1,7 mm

**27-103-58**

Fig. 2



3,2 mm

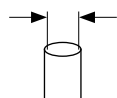
**27-103-72**

Fig. 3



4,7 mm

**27-103-87**



Innendurchmesser  
Inside diameter  
Diámetro interior  
Diámetro interno

## HARTMANN

**27-103-18** Fig. 1

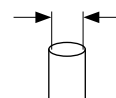
**27-103-32** Fig. 2

**27-103-46** Fig. 3

## HARTMANN

**27-103-10** Set

bestehend aus: Fig. 1 - Fig. 3 | (3 Stück)  
consisting of: Fig. 1 - Fig. 3 | (3 pieces)  
compuesto de: Fig. 1 - Fig. 3 | (3 piezas)  
composto da: Fig. 1 - Fig. 3 | (3 pezzi)



Innendurchmesser  
Inside diameter  
Diámetro interior  
Diámetro interno

## HARTMANN

**27-103-58** Fig. 1

**27-103-72** Fig. 2

**27-103-87** Fig. 3

## HARTMANN

**27-103-50** Set

bestehend aus: Fig. 1 - Fig. 3 | (3 Stück)  
consisting of: Fig. 1 - Fig. 3 | (3 pieces)  
compuesto de: Fig. 1 - Fig. 3 | (3 piezas)  
composto da: Fig. 1 - Fig. 3 | (3 pezzi)

Fig. 1



2,0 mm

**27-104-25**

Fig. 2



3,0 mm

**27-104-03**

Fig. 3



4,0 mm

**27-104-04**

Fig. 4



5,5 mm

**27-104-05**

Fig. 5



6,5 mm

**27-104-06**

Fig. 6



8,0 mm

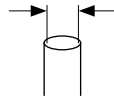
**27-104-08**

Fig. 9



9,0 mm

**27-104-09**



Innendurchmesser  
Inside diameter  
Diámetro interior  
Diámetro interno

## HARTMANN

<b>27-104-25</b>	Fig. 1
<b>27-104-03</b>	Fig. 2
<b>27-104-04</b>	Fig. 3
<b>27-104-05</b>	Fig. 4
<b>27-104-06</b>	Fig. 5
<b>27-104-08</b>	Fig. 6
<b>27-104-09</b>	Fig. 7

## HARTMANN

<b>27-104-00</b>	Set
bestehend aus:	Fig. 3 - Fig. 6 I (4 Stück)
consisting of:	Fig. 3 - Fig. 6 I (4 pieces)
compuesto de:	Fig. 3 - Fig. 6 I (4 piezas)
composto da:	Fig. 3 - Fig. 6 I (4 pezzi)

## HARTMANN

<b>27-104-01</b>	Set
bestehend aus:	Fig. 4 - Fig. 6 I (3 Stück)
consisting of:	Fig. 4 - Fig. 6 I (3 pieces)
compuesto de:	Fig. 4 - Fig. 6 I (3 piezas)
composto da:	Fig. 4 - Fig. 6 I (3 pezzi)

## HARTMANN

<b>27-104-02</b>	Set
bestehend aus:	Fig. 2 - Fig. 4 I (3 Stück)
consisting of:	Fig. 2 - Fig. 4 I (3 pieces)
compuesto de:	Fig. 2 - Fig. 4 I (3 piezas)
composto da:	Fig. 2 - Fig. 4 I (3 pezzi)

Fig. 1



3,0 mm

**27-104-30**

Fig. 2



3,5 mm

**27-104-35**

Fig. 3



4,0 mm

**27-104-40**

Fig. 4



4,5 mm

**27-104-45**

Fig. 5



5,0 mm

**27-104-50**

Fig. 6



5,5 mm

**27-104-55**

Fig. 7



6,0 mm

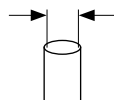
**27-104-60**

Fig. 8



6,5 mm

**27-104-65**



Innendurchmesser  
Inside diameter  
Diámetro interior  
Diámetro interno

Fig. 9



7,0 mm

**27-104-70**

Fig. 10



7,5 mm

**27-104-75**

Fig. 11



8,0 mm

**27-104-80**

Fig. 12



9,0 mm

**27-104-90**

## HARTMANN

<b>27-104-30</b>	Fig. 1
<b>27-104-35</b>	Fig. 2
<b>27-104-40</b>	Fig. 3
<b>27-104-45</b>	Fig. 4
<b>27-104-50</b>	Fig. 5
<b>27-104-55</b>	Fig. 6
<b>27-104-60</b>	Fig. 7
<b>27-104-65</b>	Fig. 8
<b>27-104-70</b>	Fig. 9
<b>27-104-75</b>	Fig. 10
<b>27-104-80</b>	Fig. 11
<b>27-104-90</b>	Fig. 12

## HARTMANN

<b>27-104-92</b>	Set
bestehend aus:	Fig. 11 - Fig. 12 I (2 Stück)
consisting of:	Fig. 11 - Fig. 12 I (2 pieces)
compuesto de:	Fig. 11 - Fig. 12 I (2 piezas)
composto da:	Fig. 11 - Fig. 12 I (2 pezzi)

## HARTMANN

<b>27-104-93</b>	Set
bestehend aus:	Fig. 1, 3, 6 I (3 Stück)
consisting of:	Fig. 1, 3, 6 I (3 pieces)
compuesto de:	Fig. 1, 3, 6 I (3 piezas)
composto da:	Fig. 1, 3, 6 I (3 pezzi)

## HARTMANN

<b>27-104-94</b>	Set
bestehend aus:	Fig. 1, 3, 6, 9 I (4 Stück)
consisting of:	Fig. 1, 3, 6, 9 I (3 pieces)
compuesto de:	Fig. 1, 3, 6, 9 I (4 piezas)
composto da:	Fig. 1, 3, 6, 9 I (4 pezzi)



Fig. 1



3,0 mm

**27-105-03**

Fig. 2



4,0 mm

**27-105-04**

Fig. 3



5,0 mm

**27-105-05**

Fig. 4



7,0 mm

**27-105-07**

Fig. 5



8,0 mm

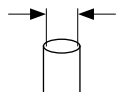
**27-105-08**

Fig. 6



9,0 mm

**27-105-09**



Innendurchmesser  
Inside diameter  
Diámetro interior  
Diámetro interno

## HARTMANN

**27-105-03** Fig. 1

**27-105-04** Fig. 2

**27-105-05** Fig. 3

**27-105-07** Fig. 4

**27-105-08** Fig. 5

**27-105-09** Fig. 6

## HARTMANN

**27-105-00** Set

bestehend aus: Fig. 1 - Fig. 4 I (4 Stück)  
consisting of: Fig. 1 - Fig. 4 I (4 pieces)  
compuesto de: Fig. 1 - Fig. 4 I (4 piezas)  
composto da: Fig. 1 - Fig. 4 I (4 pezzi)

Fig. 0



3,0 mm

**27-106-02**

Fig. 1



3,5 mm

**27-106-03**

Fig. 2



4,5 mm

**27-106-04**

Fig. 3



5,5 mm

**27-106-05**

Fig. 4



6,5 mm

**27-106-06**

Fig. 5



7,6 mm

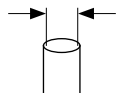
**27-106-07**

Fig. 6



9,1 mm

**27-106-09**



Innendurchmesser  
Inside diameter  
Diámetro interior  
Diámetro interno

## BOUCHERON

**27-106-02** Fig. 0

**27-106-03** Fig. 1

**27-106-04** Fig. 2

**27-106-05** Fig. 3

**27-106-06** Fig. 4

**27-106-07** Fig. 5

**27-106-09** Fig. 6

## BOUCHERON

**27-106-00** Set

bestehend aus: Fig. 1 - Fig. 4 I (4 Stück)  
consisting of: Fig. 1 - Fig. 4 I (4 pieces)  
compuesto de: Fig. 1 - Fig. 4 I (4 piezas)  
composto da: Fig. 1 - Fig. 4 I (4 pezzi)

## BOUCHERON

**27-106-01** Set

bestehend aus: Fig. 2 - Fig. 5 I (4 Stück)  
consisting of: Fig. 2 - Fig. 5 I (4 pieces)  
compuesto de: Fig. 2 - Fig. 5 I (4 piezas)  
composto da: Fig. 2 - Fig. 5 I (4 pezzi)

Fig. 1



3,0 x 4,0 mm

**27-107-01**

Fig. 2



4,0 x 5,0 mm

**27-107-02**

Fig. 3



4,5 x 5,5 mm

**27-107-03**

Fig. 4



5,0 x 6,0 mm

**27-107-04**

Fig. 5



5,5 x 6,5 mm

**27-107-05**

Fig. 6



6,0 x 7,0 mm

**27-107-06**

Fig. 7



6,5 x 7,5 mm

**27-107-07**

Fig. 8



7,0 x 8,0 mm

**27-107-08**

Fig. 9



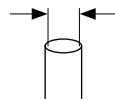
7,5 x 8,5 mm

**27-107-09**



20°

**STEEL**  
STAINLESS



Innendurchmesser  
Inside diameter  
Diámetro interior  
Diámetro interno

## FARRIOR

<b>27-107-01</b>	Fig. 1   43 mm
<b>27-107-02</b>	Fig. 2   43 mm
<b>27-107-03</b>	Fig. 3   43 mm
<b>27-107-04</b>	Fig. 4   43 mm
<b>27-107-05</b>	Fig. 5   43 mm
<b>27-107-06</b>	Fig. 6   43 mm
<b>27-107-07</b>	Fig. 7   43 mm
<b>27-107-08</b>	Fig. 8   43 mm
<b>27-107-09</b>	Fig. 9   43 mm

## FARRIOR

<b>27-107-10</b>	Set
bestehend aus:	Fig. 1 - Fig. 9   (9 Stück)
consisting of:	Fig. 1 - Fig. 9   (9 pieces)
compuesto de:	Fig. 1 - Fig. 9   (9 piezas)
composto da:	Fig. 1 - Fig. 9   (9 pezzi)

## FARRIOR

<b>27-107-00</b>	Set
bestehend aus:	Fig. 1,2,5,7,9   (5 Stück)
consisting of:	Fig. 1,2,5,7,9   (5 pieces)
compuesto de:	Fig. 1,2,5,7,9   (5 piezas)
composto da:	Fig. 1,2,5,7,9   (5 pezzi)

Fig. 1



3,0 x 4,0 mm

**27-107-11**

Fig. 2



4,0 x 5,0 mm

**27-107-12**

Fig. 3



4,5 x 5,5 mm

**27-107-13**

Fig. 4



5,0 x 6,0 mm

**27-107-14**

Fig. 5



5,5 x 6,5 mm

**27-107-15**

Fig. 6



6,0 x 7,0 mm

**27-107-16**

Fig. 7



6,5 x 7,5 mm

**27-107-17**

Fig. 8



7,0 x 8,0 mm

**27-107-18**

Fig. 9



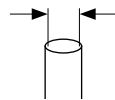
7,5 x 8,5 mm

**27-107-19**



35°

**STEEL**  
STAINLESS



Innendurchmesser  
Inside diameter  
Diámetro interior  
Diámetro interno

## FARRIOR

<b>27-107-11</b>	Fig. 1   43 mm
<b>27-107-12</b>	Fig. 2   43 mm
<b>27-107-13</b>	Fig. 3   43 mm
<b>27-107-14</b>	Fig. 4   43 mm
<b>27-107-15</b>	Fig. 5   43 mm
<b>27-107-16</b>	Fig. 6   43 mm
<b>27-107-17</b>	Fig. 7   43 mm
<b>27-107-18</b>	Fig. 8   43 mm
<b>27-107-19</b>	Fig. 9   43 mm

## FARRIOR

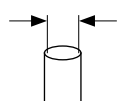
<b>27-107-20</b>	Set
bestehend aus:	Fig. 1 - Fig. 9   (9 Stück)
consisting of:	Fig. 1 - Fig. 9   (9 pieces)
compuesto de:	Fig. 1 - Fig. 9   (9 piezas)
composto da:	Fig. 1 - Fig. 9   (9 pezzi)

## FARRIOR

<b>27-107-21</b>	Set
bestehend aus:	Fig. 1,2,5,7,9   (5 Stück)
consisting of:	Fig. 1,2,5,7,9   (5 pieces)
compuesto de:	Fig. 1,2,5,7,9   (5 piezas)
composto da:	Fig. 1,2,5,7,9   (5 pezzi)



Fig. 0	Fig. 1	Fig. 2	Fig. 3	Fig. 4
2,0 mm	3,0 mm	4,0 mm	5,0 mm	6,0 mm
<b>27-108-02</b>	<b>27-108-03</b>	<b>27-108-04</b>	<b>27-108-05</b>	<b>27-108-06</b>



Innendurchmesser  
Inside diameter  
Diámetro interior  
Diámetro interno

## TOYNBEE

<b>27-108-02</b>	Fig. 0   33 mm
<b>27-108-03</b>	Fig. 1   36 mm
<b>27-108-04</b>	Fig. 2   36 mm
<b>27-108-05</b>	Fig. 3   36 mm
<b>27-108-06</b>	Fig. 4   35 mm

## TOYNBEE

<b>27-108-10</b>	Set
bestehend aus:	Fig. 0 - Fig. 4   (5 Stück)
consisting of:	Fig. 0 - Fig. 4   (5 pieces)
compuesto de:	Fig. 0 - Fig. 4   (5 piezas)
composto da:	Fig. 0 - Fig. 4   (5 pezzi)

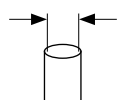
## TOYNBEE

<b>27-108-00</b>	Set
bestehend aus:	Fig. 1 - Fig. 4   (4 Stück)
consisting of:	Fig. 1 - Fig. 4   (4 pieces)
compuesto de:	Fig. 1 - Fig. 4   (4 piezas)
composto da:	Fig. 1 - Fig. 4   (4 pezzi)

## TOYNBEE

<b>27-108-01</b>	Set
bestehend aus:	Fig. 2 - Fig. 4   (3 Stück)
consisting of:	Fig. 2 - Fig. 4   (3 pieces)
compuesto de:	Fig. 2 - Fig. 4   (3 piezas)
composto da:	Fig. 2 - Fig. 4   (3 pezzi)

Fig. 1	Fig. 2	Fig. 3	Fig. 4
2,8 x 3,8 mm	3,8 x 4,8 mm	5,0 x 6,2 mm	6,0 x 7,2 mm
<b>27-109-04</b>	<b>27-109-05</b>	<b>27-109-06</b>	<b>27-109-07</b>



Innendurchmesser  
Inside diameter  
Diámetro interior  
Diámetro interno

## GRUBER

<b>27-109-04</b>	Fig. 1   42 mm
<b>27-109-05</b>	Fig. 2   42 mm
<b>27-109-06</b>	Fig. 3   42 mm
<b>27-109-07</b>	Fig. 4   42 mm

## GRUBER

<b>27-109-00</b>	Set
bestehend aus:	Fig. 1 - Fig. 4   (4 Stück)
consisting of:	Fig. 1 - Fig. 4   (4 pieces)
compuesto de:	Fig. 1 - Fig. 4   (4 piezas)
composto da:	Fig. 1 - Fig. 4   (4 pezzi)

## GRUBER

<b>27-109-01</b>	Set
bestehend aus:	Fig. 2 - Fig. 4   (3 Stück)
consisting of:	Fig. 2 - Fig. 4   (3 pieces)
compuesto de:	Fig. 2 - Fig. 4   (3 piezas)
composto da:	Fig. 2 - Fig. 4   (3 pezzi)

Fig. 0



2,0 mm

**27-110-03**

Fig. 1



3,0 mm

**27-110-04**

Fig. 2



4,0 mm

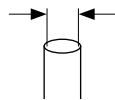
**27-110-05**

Fig. 3



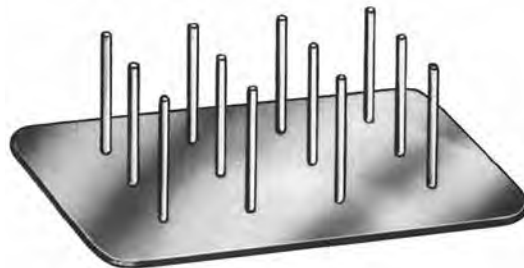
5,0 mm

**27-110-06**



Innendurchmesser  
Inside diameter  
Diámetro interior  
Diámetro interno

Lagerungsgestell für 12 Ohrspekula  
Rack for 12 ear speculas  
Soporte para 12 espéculos auriculares  
Telaio per speculi auricolari



## RICHNAU-HOLMGREN

**27-110-03** Fig. 0 | 37 mm

**27-110-04** Fig. 1 | 37 mm

**27-110-05** Fig. 2 | 37 mm

**27-110-06** Fig. 3 | 37 mm

**27-110-99**



Fig. 1



5,0 mm

**27-118-02**

Fig. 2



6,0 mm

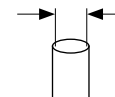
**27-118-03**

Fig. 3



7,0 mm

**27-118-04**



Innendurchmesser  
Inside diameter  
Diámetro interior  
Diámetro interno

## SIEGLE

**27-118-00** SET

Komplett, bestehend aus:

1 Gebläse	<b>27-118-01</b>
1 Ohrspekula, Ø 5,0 mm	<b>27-118-02</b>
1 Ohrspekula, Ø 6,0 mm	<b>27-118-03</b>
1 Ohrspekula, Ø 7,0 mm	<b>27-118-04</b>
1 Lupenkörper	<b>27-118-05</b>

Complete, consisting of:

1 Rubber bulb	<b>27-118-01</b>
1 Ear specula, Ø 5,0 mm	<b>27-118-02</b>
1 Ear specula, Ø 6,0 mm	<b>27-118-03</b>
1 Ear specula, Ø 7,0 mm	<b>27-118-04</b>
1 Diagnostic head	<b>27-118-05</b>

Completo, compuesto de:

1 Pera de goma	<b>27-118-01</b>
1 Espéculo, Ø 5,0 mm	<b>27-118-02</b>
1 Espéculo, Ø 6,0 mm	<b>27-118-03</b>
1 Espéculo, Ø 7,0 mm	<b>27-118-04</b>
1 Cuerpo de lupa	<b>27-118-05</b>

Completo, composto da:

1 Mantico con tubo	<b>27-118-01</b>
1 Speculo, Ø 5,0 mm	<b>27-118-02</b>
1 Speculo, Ø 6,0 mm	<b>27-118-03</b>
1 Speculo, Ø 7,0 mm	<b>27-118-04</b>
1 Portalente pieno	<b>27-118-05</b>





## BRUENINGS

### 27-120-00 SET

Komplett in Etui bestehend aus:	Complete in case, consisting of:
1 Ohrspekula, Ø 3,0 mm	1 Ear specula, Ø 3,0 mm
1 Ohrspekula, Ø 4,0 mm	1 Ear specula, Ø 4,0 mm
1 Ohrspekula, Ø 5,0 mm	1 Ear specula, Ø 5,0 mm
1 Ohrspekula, Ø 6,5 mm	1 Ear specula, Ø 6,5 mm
1 Gebläse mit Schlauch	1 Rubber bulb with tube
1 Lupenkörper, volles Fenster	1 Diagnostic head, full lens

Completo en estuche, compuesto de:	Completo con casetta, composto da:
1 Espéculo auricular, Ø 3,0 mm	1 Speculo auricolare, Ø 3,0 mm
1 Espéculo auricular, Ø 4,0 mm	1 Speculo auricolare, Ø 4,0 mm
1 Espéculo auricular, Ø 5,0 mm	1 Speculo auricolare, Ø 5,0 mm
1 Espéculo auricular, Ø 6,5 mm	1 Speculo auricolare, Ø 6,5 mm
1 Pera de goma con tubo	1 Mantico con tubo in gomma
1 Cuerpo de lupa, lleno	1 Portalente, pieno

## BRUENINGS

### 27-121-00 SET

Komplett in Etui bestehend aus:	Complete in case, consisting of:
1 Ohrspekula, Ø 2,5 mm	1 Ear specula, Ø 2,5 mm
1 Ohrspekula, Ø 3,0 mm	1 Ear specula, Ø 3,0 mm
1 Ohrspekula, Ø 4,0 mm	1 Ear specula, Ø 4,0 mm
1 Ohrspekula, Ø 5,0 mm	1 Ear specula, Ø 5,0 mm
1 Ohrspekula, Ø 6,5 mm	1 Ear specula, Ø 6,5 mm
1 Ohrspekula, Ø 8,5 mm	1 Ear specula, Ø 8,5 mm
1 Gebläse mit Schlauch	1 Rubber bulb with tube
1 Lupenkörper, volles Fenster	1 Diagnostic head, full lens
1 Lupenkörper, Segment Ausschnitt	1 Diagnostic head, segmented lens

Completo en estuche, compuesto de:	Completo con casetta, composto da:
1 Espéculo auricular, Ø 2,5 mm	1 Speculo auricolare, Ø 2,5 mm
1 Espéculo auricular, Ø 3,0 mm	1 Speculo auricolare, Ø 3,0 mm
1 Espéculo auricular, Ø 4,0 mm	1 Speculo auricolare, Ø 4,0 mm
1 Espéculo auricular, Ø 5,0 mm	1 Speculo auricolare, Ø 5,0 mm
1 Espéculo auricular, Ø 6,5 mm	1 Speculo auricolare, Ø 6,5 mm
1 Espéculo auricular, Ø 8,5 mm	1 Speculo auricolare, Ø 8,5 mm
1 Pera de goma con tubo	1 Mantico con tubo in gomma
1 Cuerpo de lupa, lleno	1 Portalente, pieno
1 Cuerpo de lupa, cortadura segmento	1 Portalente, parte de segmento

Fig. 1



2,5 mm

Fig. 2



3,0 mm

Fig. 3



4,0 mm

Fig. 4



5,0 mm

Fig. 5

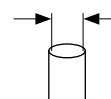


6,5 mm

Fig. 6



8,5 mm



Innendurchmesser  
Inside diameter  
Diámetro interior  
Diámetro interno



stumpf, gerade  
blunt, straight  
roma, recta  
smussa, retta



stumpf, abgewinkelt  
blunt, angled  
roma, acodado  
smussa, angolati



scharf, gerade  
sharp, straight  
agudo, recta  
acuto, retta



<b>27-150-01</b>	1,5mm   Fig. 000
<b>27-150-02</b>	2,0mm   Fig. 00
<b>27-150-03</b>	2,5mm   Fig. 0
<b>27-150-04</b>	3,0mm   Fig. 1
<b>27-150-05</b>	3,5mm   Fig. 2
<b>27-150-06</b>	4,0mm   Fig. 3
<b>27-150-07</b>	4,5mm   Fig. 4
<b>27-150-08</b>	5,0mm   Fig. 5

<b>27-151-01</b>	1,5mm   Fig. 000
<b>27-151-02</b>	2,0mm   Fig. 00
<b>27-151-03</b>	2,5mm   Fig. 0
<b>27-151-04</b>	3,0mm   Fig. 1
<b>27-151-05</b>	3,5mm   Fig. 2
<b>27-151-06</b>	4,0mm   Fig. 3
<b>27-151-07</b>	4,5mm   Fig. 4
<b>27-151-08</b>	5,0mm   Fig. 5

<b>27-152-01</b>	1,5mm   Fig. 000
<b>27-152-02</b>	2,0mm   Fig. 00
<b>27-152-03</b>	2,5mm   Fig. 0
<b>27-152-04</b>	3,0mm   Fig. 1
<b>27-152-05</b>	3,5mm   Fig. 2
<b>27-152-06</b>	4,0mm   Fig. 3
<b>27-152-07</b>	4,5mm   Fig. 4
<b>27-152-08</b>	5,0mm   Fig. 5

Ohrküretten  
Ear cures  
Curetas auriculares  
Curette auricolari

scharf, abgewinkelt  
sharp, angled  
agudo, acodado  
acuto, angolati



<b>27-153-01</b>	1,5mm   Fig. 000
<b>27-153-02</b>	2,0mm   Fig. 00
<b>27-153-03</b>	2,5mm   Fig. 0
<b>27-153-04</b>	3,0mm   Fig. 1
<b>27-153-05</b>	3,5mm   Fig. 2
<b>27-153-06</b>	4,0mm   Fig. 3
<b>27-153-07</b>	4,5mm   Fig. 4
<b>27-153-08</b>	5,0mm   Fig. 5

## BUCK

**27-150-01 - 27-153-08** 17,0 cm, 6 3/4"



stumpf  
blunt  
roma  
smussa

**27-155-13**

Ohrschlinge  
Ear loop  
Asas auriculares  
Anse auricolari



**27-155-16**



**27-155-17**

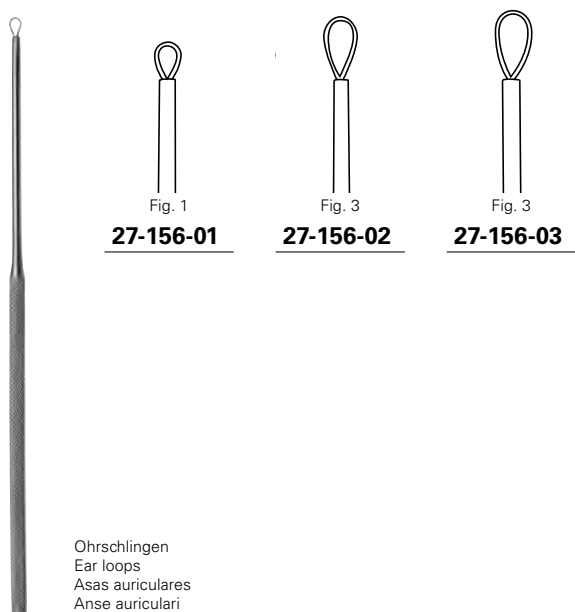
Ohrschlingen  
Ear loops  
Asas auriculares  
Anse auricolari

## LANGENBECK

**27-155-13** 13,0 cm, 5 1/8"

## SNELLEN

**27-155-16 - 27-155-17** 16,0 cm, 6 1/4"



Ohrschlingen  
 Ear loops  
 Asas auriculares  
 Anse auricolari

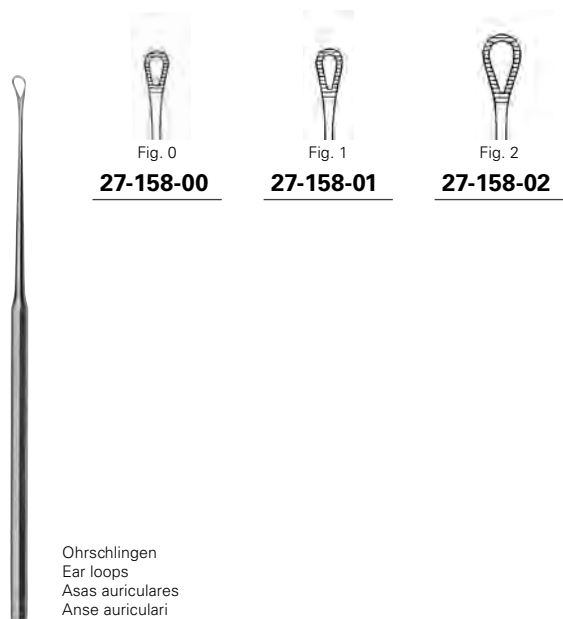
Ohrküretten  
 Ear cures  
 Curetas auriculares  
 Curette auricolari

### BILLEAU

**27-156-01 - 27-156-03** 16,0 cm, 6 ¼"

### WEISMAN

**27-157-02 - 27-157-03** 14,0 cm, 5 ½"



Ohrschlingen  
 Ear loops  
 Asas auriculares  
 Anse auricolari

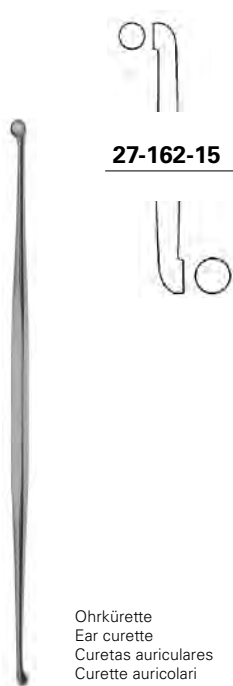
Ohrschlingen  
 Ear loops  
 Asas auriculares  
 Anse auricolari

### WEBER-LOCH

**27-158-00 - 27-158-02** 14,5 cm, 5 ¾"

### SHAPLEIGH

**27-160-01 - 27-160-04** 13,0 cm, 5 ⅛"



**27-162-15**

Ohrkürette  
Ear curette  
Curetas auriculares  
Curette auricolari

**JANSEN**

**27-162-15** 15,0 cm, 6"

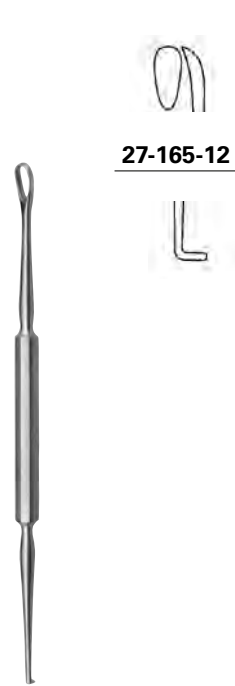


**27-164-18**

Ohrkürette  
Ear curette  
Curetas auriculares  
Curette auricolari

**BARTH**

**27-164-18** 18,0 cm, 7"

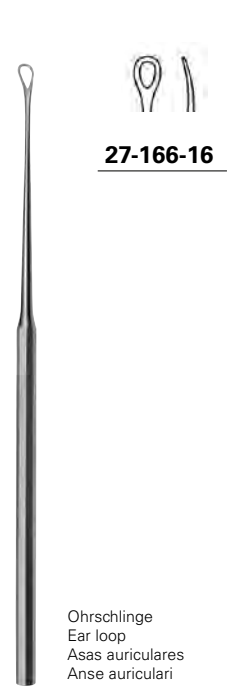


**27-165-12**

Ohrkürette  
Ear curette  
Curette auricolari

**GROSS**

**27-165-12** 13,0 cm, 5"

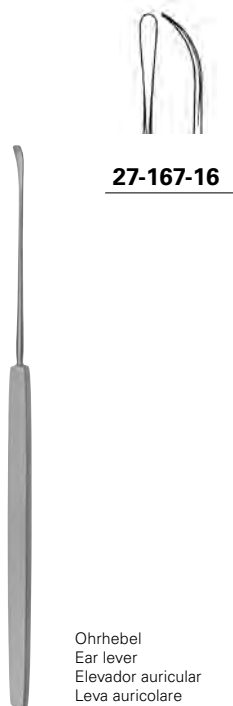


**27-166-16**

Ohrschlinge  
Ear loop  
Asas auriculares  
Anse auricolari

**WEBER-LOCH**

**27-166-16** 16,5 cm, 6 1/2"

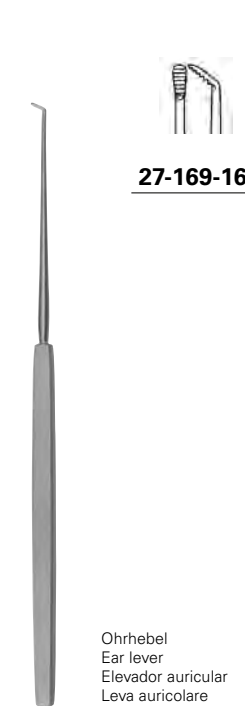


**27-167-16**

Ohrhebel  
Ear lever  
Elevador auricular  
Leva auricolare

**ZAUFAL**

**27-167-16** 15,0 cm, 6"



**27-169-16**

Ohrhebel  
Ear lever  
Elevador auricular  
Leva auricolare

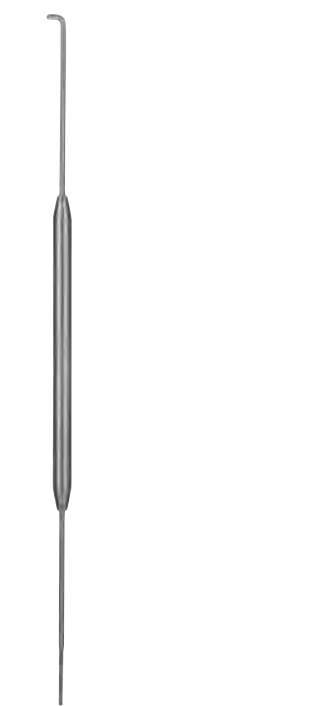
**MOLDENHAUER**

**27-169-16** 16,0 cm, 6 1/4"



**FORMBY**

**27-170-17** 18,0 cm, 7"



**MUSGROVE**

**27-172-18** 18,0 cm, 7"

Zerumenlöffel und Häkchen  
Cerumen scoop and hook  
Cucharilla de cerumen y ganchitos  
Cucchiaio per cerume e gancio

Zerumennadel und Watteträger  
Cerumen pick and wool carrier  
Aguja de cerumen y aplicadores de algodón  
Ago per cerume e portagarze

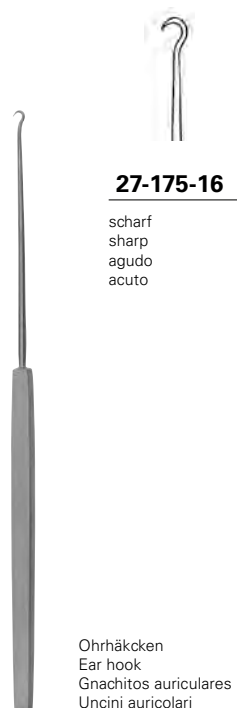


**27-173-15**

Ohrhäkcken  
 Ear hook  
 Gnachitos auriculares  
 Uncini auricolari

**ZAUFAL-JANSEN**

**27-173-15** 15,0 cm, 6 "



**27-175-16**

scharf  
 sharp  
 agudo  
 acuto

Ohrhäkcken  
 Ear hook  
 Gnachitos auriculares  
 Uncini auricolari

**HARTMANN**

**27-175-16** 16,0 cm, 6 ¼ "



Fig. 1

**27-181-01**

Ohrhäkcken  
 Ear hooks  
 Gnachitos auriculares  
 Uncini auricolari

**DAY**

**27-181-01 - 27-181-02** 17,0 cm, 6 ¾ "

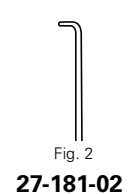


Fig. 2

**27-181-02**

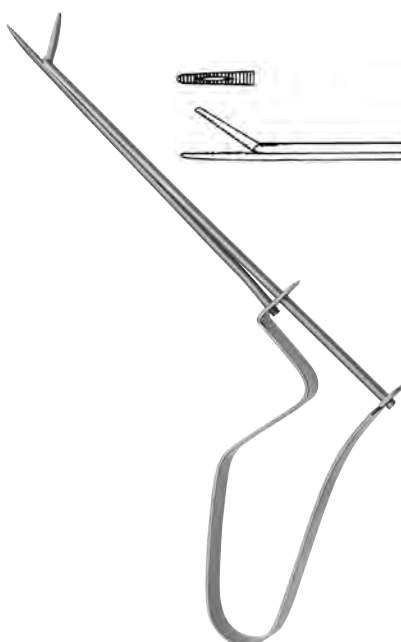
Fremdkörperheber  
 Foreign body lever  
 Elevador para cuerpos extraños  
 Leva per corpi estranei



**QUIRE**

**27-200-09** 10,5 cm, 4 ¼ "

Fremdkörperzängchen  
 Foreign body forceps  
 Pinza para cuerpos extraños  
 Pinze per corpi estranei



**BUCK**

**27-202-09** 11,5 cm, 4 ¼ "



**27-204-12**



**LITTAUER**

**27-204-12** 12,0 cm, 4 3/4"



**27-206-12**



**HARTMANN**

**27-206-12** 12,0 cm, 4 3/4"



**27-208-14**



**HARTMANN**

**27-208-14** 14,0 cm, 5 1/2"



**HARTMANN**

**27-209-14** 8,5 cm, 3 1/3"

Faßzängchen, schnabelförmiges Maul  
Grasping forceps, duckbill jaw  
Pinza de agarre, en forma de pico  
Pinte da presa, a forma di becco d'oca



0,8 x 6,0 mm

**HARTMANN-WULLSTEIN**

**27-210-07** 8,5 cm, 3 1/3"

Faßzängchen  
Grasping forceps  
Pinza de agarre  
Pinte da presa



1,8 x 8,0 mm

**HARTMANN-WULLSTEIN**

**27-210-08** 8,5 cm, 3 1/3"

Faßzängchen  
Grasping forceps  
Pinza de agarre  
Pinte da presa



**HARTMANN**

**27-214-08** 8,5 cm, 3 1/3"

**27-214-14** 14,0 cm, 5 1/2"

**27-214-16** 16,5 cm, 6 1/2"

Faßzängchen  
Grasping forceps  
Pinza de agarre  
Pinte da presa



**HARTMANN**

**27-215-01** 15,0 cm, 6"

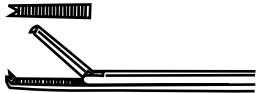
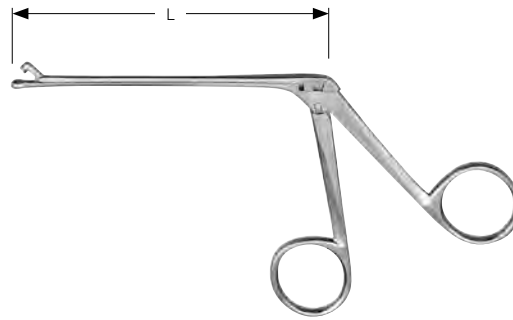
Faßzängchen, fein, gerieft  
Grasping forceps, delicate, serrated  
Pinza de agarre, fino, estriado  
Pinte da presa, delicato, rigato



**HARTMANN**

**27-215-02** 15,0 cm, 6"

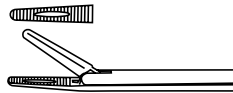
Faßzängchen, grob, gerieft  
Grasping forceps, rough, serrated  
Pinza de agarre, ápero, estriado  
Pinte da presa, colossale, rigato



### HARTMANN

**27-216-08** 8,5 cm, 3 1/3 "  
**27-216-14** 14,0 cm, 5 1/2 "

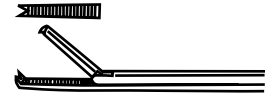
Faßzängchen, 1 x 2 Zähne  
Grasping forceps, 1 x 2 teeth  
Pinza de agarre, 1 x 2 dientes  
Pinte da presa, 1 x 2 denti



### HARTMANN-NOYES

**27-218-09** 8,5 cm, 3 1/3 "

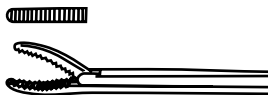
Faßzängchen  
Grasping forceps  
Pinza de agarre  
Pinte da presa



### HARTMANN-NOYES

**27-220-09** 8,5 cm, 3 1/3 "

Faßzängchen, 1 x 2 Zähne  
Grasping forceps, 1 x 2 teeth  
Pinza de agarre, 1 x 2 dientes  
Pinte da presa, 1 x 2 denti



### HARTMANN-WEINGAERTNER

**27-222-08** 8,5 cm, 3 1/3 "

Faßzängchen  
Grasping forceps  
Pinza de agarre  
Pinte da presa



### HARTMANN

**27-224-08** 8,5 cm, 3 1/3 "

Löffelzängchen, oval  
Spoon forceps, oval  
Pinza de copas, oval  
Pinza a cucchiaio, ovale



### HARTMANN

**27-224-18** 18,0 cm, 7 "

Löffelzängchen, oval  
Spoon forceps, oval  
Pinza de copas, oval  
Pinza a cucchiaio, ovale



### HARTMANN

**27-224-18 B** 18,0 cm, 7 "

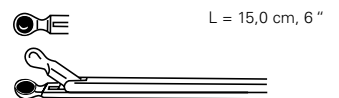
Löffelzängchen, oval  
Spoon forceps, oval  
Pinza de copas, oval  
Pinza a cucchiaio, ovale



### HARTMANN

**27-226-01** Ø 2,0 mm  
**27-226-02** Ø 2,5 mm  
**27-226-03** Ø 3,0 mm

Löffelzängchen  
Spoon forceps  
Pinza de copas  
Pinza a cucchiaio



### HARTMANN

**27-226-11** Ø 2,0 mm

Löffelzängchen  
Spoon forceps  
Pinza de copas  
Pinza a cucchiaio



### HARTMANN

**27-226-12** Ø 2,5 mm

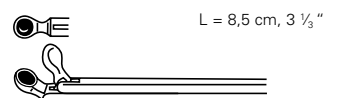
Löffelzängchen  
Spoon forceps  
Pinza de copas  
Pinza a cucchiaio



### HARTMANN-HOFFMANN

**27-226-20** Ø 2,0 mm

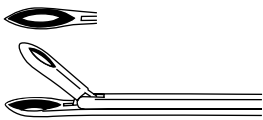
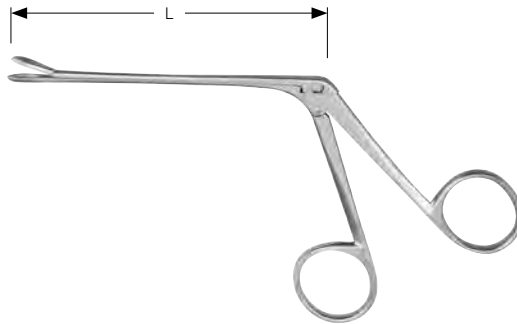
Löffelzängchen, durchschneidend  
Spoon forceps, through cutting  
Pinza de copas, cortante  
Pinza a cucchiaio, tagliente



### HARTMANN

**27-228-07** Ø 2,0 mm  
**27-228-08** Ø 3,0 mm

Löffelzängchen, 45°  
Spoon forceps, 45°  
Pinza de copas, 45°  
Pinza a cucchiaio, 45°



**STRUEMPEL**

**27-230-08** 8,5 cm, 3 1/3 "  
**27-230-18** 12,5 cm, 5 "

Löffelzängchen, oval  
Spoon forceps, oval  
Pinza de copas, oval  
Pinza a cucchiaio, ovale

**STRUEMPEL**

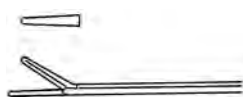
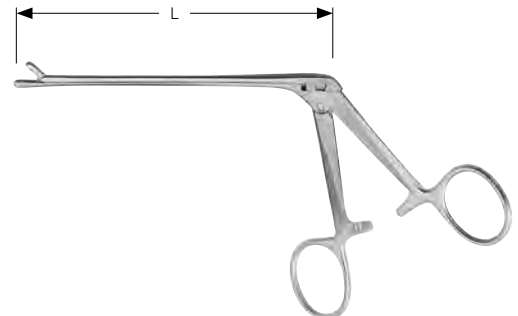
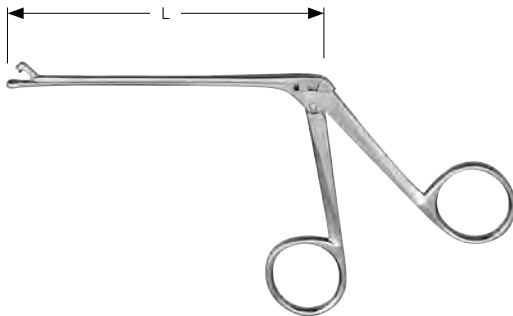
**27-230-19** 12,5 cm, 5 "

Löffelzängchen, oval, 45°  
Spoon forceps, oval, 45°  
Pinza de copas, oval, 45°  
Pinza a cucchiaio, ovale, 45°

**STRUEMPEL**

**27-230-20** 12,5 cm, 5 "

Löffelzängchen, oval, 90°  
Spoon forceps, oval, 90°  
Pinza de copas, oval, 90°  
Pinza a cucchiaio, ovale, 90°



**MASING**

**27-231-12** 12,5 cm, 5 "

Faßzängchen, 45°  
Grasping forceps, 45°  
Pinza de agarre, 45°  
Pinte da presa, 45°

**27-234-15** 8,5 cm, 3 1/3 "

Nadelhalter  
Needle holder  
Porta aguja  
Portaghi

**27-236-15** 8,5 cm, 3 1/3 "

Nadelhalter  
Needle holder  
Porta aguja  
Portaghi





**27-300-15**



Periostmesser  
 Periosteal knife  
 Cuchillo para periostio  
 Coltello periostio

**MUCK**

**27-300-15** 15,0 cm, 6 "



**27-301-15**



Myringotom  
 Myringotome  
 Miringotomo  
 Miringotomo

**BUCK**

**27-301-15** 15,0 cm, 6 "



**27-303-16**



Furunkelmesser  
 Furuncle knife  
 Cuchillo para furúnculo  
 Bisturi per foruncoli

**POLITZER**

**27-303-16** 16,0 cm, 6 ¼ "



**27-304-18**



Parazentesenadel  
 Tympanum perforator  
 Aguja para paracentesis  
 Ago per paracentesi

**SEXTON**

**27-304-18** 18,0 cm, 7 "



**27-305-17**



Parazentesenadel  
 Tympanum perforator  
 Aguja para paracentesis  
 Ago per paracentesi

**SEXTON**

**27-305-17** 17,0 cm, 6 ¾ "



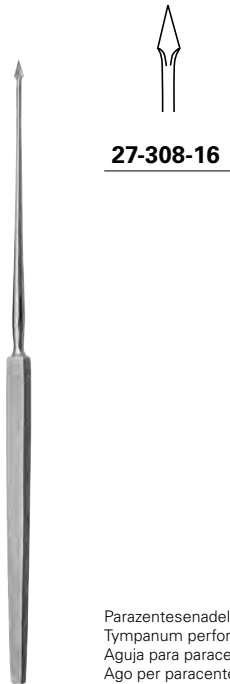
**27-306-17**



Parazentesenadel  
 Tympanum perforator  
 Aguja para paracentesis  
 Ago per paracentesi

**GERZOG-SEXTON**

**27-306-17** 17,0 cm, 6 ¾ "

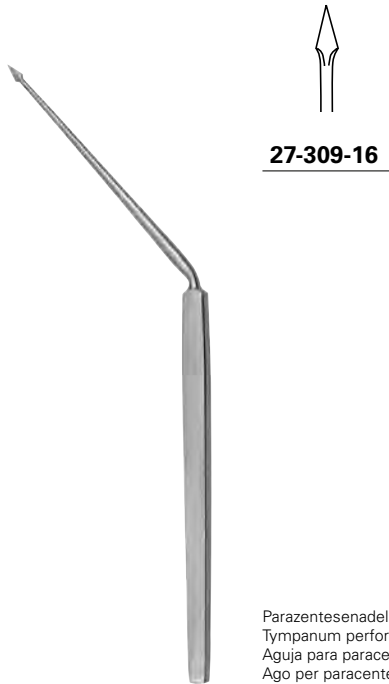


**27-308-16**

Parazentesenadel  
Tympanum perforator  
Aguja para paracentesis  
Ago per paracentesi

**POLITZER**

**27-308-16** 16,5 cm, 6 1/2"



**27-309-16**

Parazentesenadel  
Tympanum perforator  
Aguja para paracentesis  
Ago per paracentesi

**POLITZER**

**27-309-16** 16,5 cm, 6 1/2"



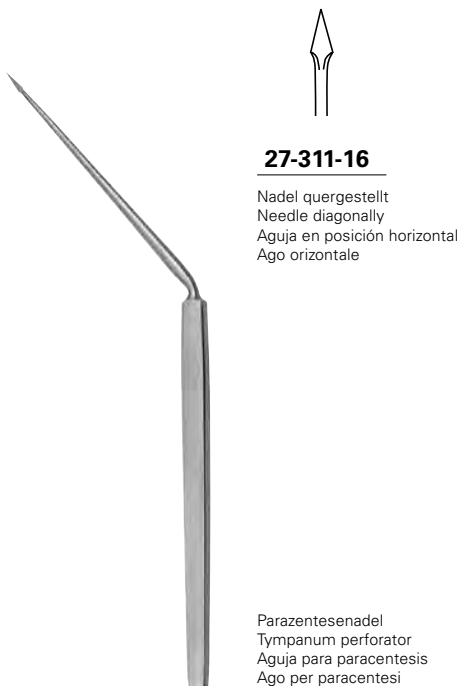
**27-310-99**

Ersatznadel  
Spare needle  
Aguja de repuesto  
Ago di ricambio

Parazentesenadel  
Tympanum perforator  
Aguja para paracentesis  
Ago per paracentesi

**POLITZER**

**27-310-17** 17,0 cm, 6 3/4"



**27-311-16**

Nadel quergestellt  
Needle diagonally  
Aguja en posición horizontal  
Ago orizzontale

Parazentesenadel  
Tympanum perforator  
Aguja para paracentesis  
Ago per paracentesi

**POLITZER**

**27-311-16** 16,5 cm, 6 1/2"



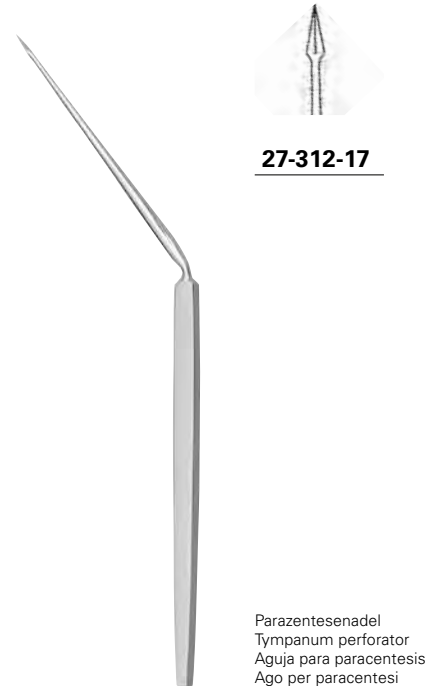
**27-311-17**

Nadel quergestellt  
Needle diagonally  
Aguja en posición horizontal  
Ago orizzontale

Parazentesenadel  
Tympanum perforator  
Aguja para paracentesis  
Ago per paracentesi

**POLITZER**

**27-311-17** 16,5 cm, 6 1/2"

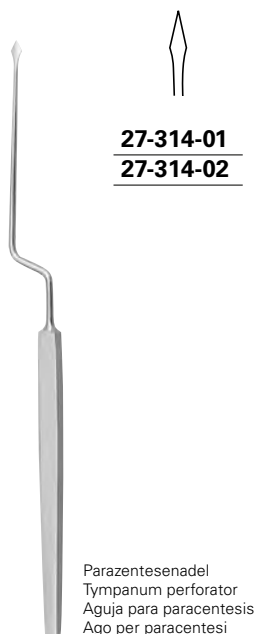


**27-312-17**

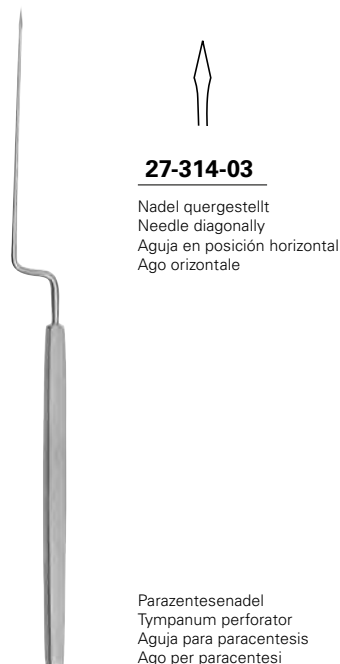
Parazentesenadel  
Tympanum perforator  
Aguja para paracentesis  
Ago per paracentesi

**AGNEW**

**27-312-17** 17,5 cm, 7"



Parazentesadel  
 Tympanum perforator  
 Aguja para paracentesis  
 Ago per paracentesi



**27-314-03**  
 Nadel quergestellt  
 Needle diagonally  
 Aguja en posición horizontal  
 Ago orizzontale

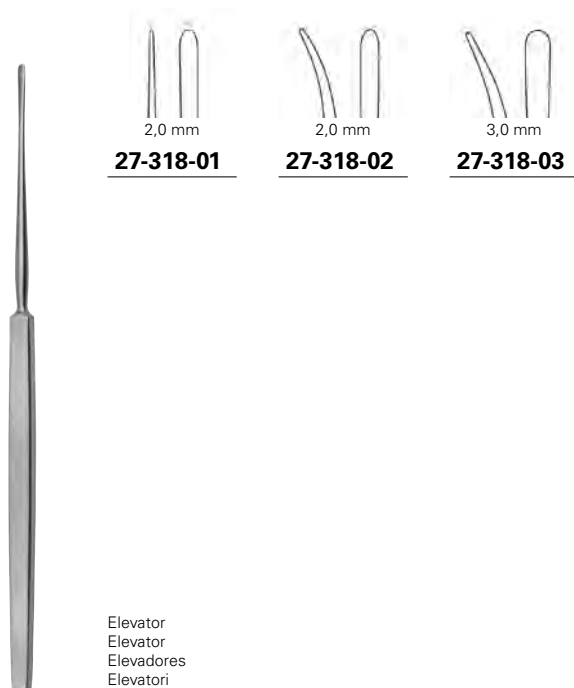
Parazentesadel  
 Tympanum perforator  
 Aguja para paracentesis  
 Ago per paracentesi

### LUCAE

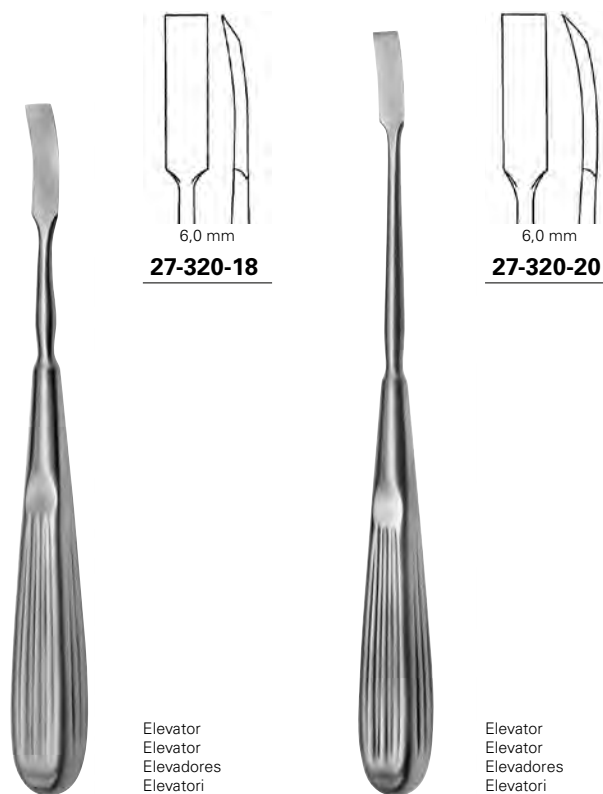
**27-314-01** 16,0 cm, 6 ¼"  
**27-314-02** 18,0 cm, 7"

### LUCAE

**27-314-03** 17,5 cm, 7"



Elevator  
 Elevator  
 Elevadores  
 Elevatori



Elevator  
 Elevator  
 Elevadores  
 Elevatori

Elevator  
 Elevator  
 Elevadores  
 Elevatori

### LEMPERT

**27-318-01 - 27-318-03** 16,5 cm, 6 ½"

### LEMPERT

**27-320-18** 18,0 cm, 7"

### LEMPERT

**27-320-20** 20,5 cm, 8"



**KRAUSE**

**27-351-16** 18,0 cm, 7 "



**KRAUSE-VOSS**

**27-353-16** 18,0 cm, 7 "



**LANGE-WILDE**

**27-355-16** 16,0 cm, 6 ¼ "



Verpackungseinheit: 12 St.  
Packing unit: 12 pieces  
Unidad: 12 piezas  
Confezione: 12 pezzi



Verpackungseinheit: 100 St.  
Packing unit: 100 pieces  
Unidad: 100 piezas  
Confezione: 100 pezzi

Schnürdrähte, Rolle mit 10 m  
Snare wires, coil of 10 m  
Alambre para amigdalótomo, rollo de 10 m  
Filo per serranodi, rotolo da 10 m



**27-358-30** Ø 0,3 mm  
**27-358-40** Ø 0,4 mm

Schnürdrähte  
Snare wires  
Alambre para amigdalótomo  
Filo per serranodi

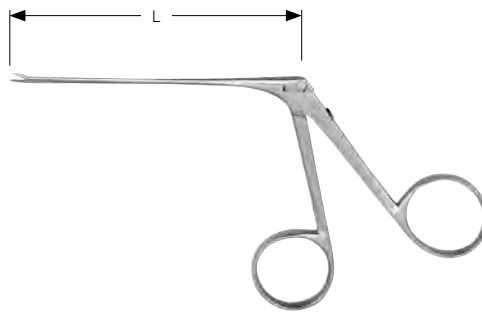


**27-359-12** Ø 0,2 mm

Schnürdrähte  
Snare wires  
Alambre para amigdalótomo  
Filo per serranodi



**27-359-99** Ø 0,2 mm



	L = 8,0 cm, 3 1/8"		L = 8,0 cm, 3 1/8"		L = 12,5 cm, 5"		L = 8,0 cm, 3 1/8"
<b>27-400-01</b>	4,0 x 0,8 mm	<b>27-400-02</b>	4,0 x 0,8 mm	<b>27-400-12</b>	4,0 x 0,8 mm	<b>27-400-03</b>	4,0 x 0,8 mm
<b>27-402-01</b>	4,0 x 0,6 mm	<b>27-402-02</b>	4,0 x 0,6 mm	<b>27-402-12</b>	4,0 x 0,6 mm	<b>27-402-03</b>	4,0 x 0,6 mm
<b>27-404-01</b>	3,5 x 0,6 mm	<b>27-404-02</b>	3,5 x 0,6 mm				

glatt, gerade  
 smooth, straight  
 lisa, recta  
 liscia, retta

gerieft, gerade  
 serrated, straight  
 estriada, recta  
 con scanalatura, retta

gerieft, gerade  
 serrated, straight  
 estriada, recta  
 con scanalatura, retta

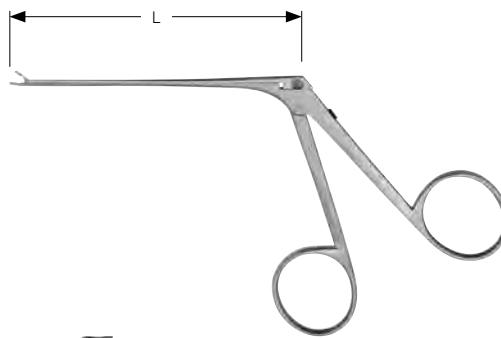
gerieft, aufgebogen  
 serrated, curved upwards  
 estriada, curba por arriba  
 con scanalatura, curva in alto

	L = 8,0 cm, 3 1/8"		L = 8,0 cm, 3 1/8"		L = 8,0 cm, 3 1/8"
<b>27-400-04</b>	4,0 x 0,8 mm	<b>27-400-05</b>	4,0 x 0,8 mm	<b>27-400-06</b>	4,0 x 0,8 mm
<b>27-402-04</b>	4,0 x 0,6 mm	<b>27-402-05</b>	4,0 x 0,6 mm	<b>27-402-06</b>	4,0 x 0,6 mm

gerieft, rechts  
 serrated, right  
 estriada, derecha  
 con scanalatura, destra

gerieft, links  
 serrated, left  
 estriada, izquierda  
 con scanalatura, sinistra

gerieft, abgebogen  
 serrated, curved downwards  
 estriada, curba por abajo  
 con scanalatura, curva in basso



## WULLSTEIN

	L = 12,5 cm, 5"		L = 8,0 cm, 3 1/8"		L = 8,0 cm, 3 1/8"
<b>27-406-00</b>	Ø 1,0 mm	<b>27-405-01</b>	1,5 x 0,8 mm	<b>27-405-02</b>	1,5 x 0,8 mm
		<b>27-406-01</b>	1,0 x 0,9 mm	<b>27-406-02</b>	1,0 x 0,9 mm
		<b>27-408-01</b>	0,6 x 0,5 mm	<b>27-408-02</b>	0,6 x 0,5 mm

gerade, rund  
 straight, round  
 recta, redondo  
 retta, rotondo

gerade, oval  
 straight, oval  
 recta, oval  
 retta, ovale

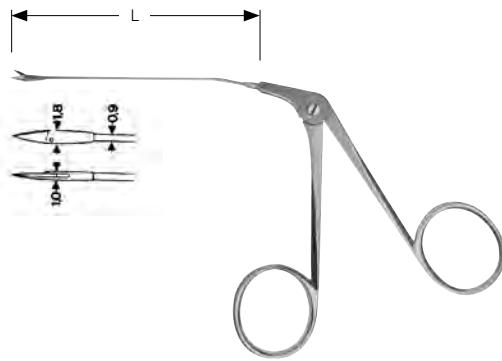
aufgebogen, oval  
 curved upwards, oval  
 curba por arriba, oval  
 curva in alto, ovale

	L = 8,0 cm, 3 1/8"		L = 8,0 cm, 3 1/8"		L = 8,0 cm, 3 1/8"
<b>27-405-03</b>	1,5 x 0,8 mm	<b>27-405-04</b>	1,5 x 0,8 mm	<b>27-405-05</b>	1,5 x 0,8 mm
<b>27-406-03</b>	1,0 x 0,9 mm	<b>27-406-04</b>	1,0 x 0,9 mm	<b>27-406-05</b>	1,0 x 0,9 mm
<b>27-408-03</b>	0,6 x 0,5 mm	<b>27-408-04</b>	0,6 x 0,5 mm	<b>27-408-05</b>	0,6 x 0,5 mm

rechts, oval  
 right, oval  
 derecha, oval  
 destra, ovale

links, oval  
 left, oval  
 izquierda, oval  
 sinistra, ovale

abgebogen, oval  
 curved downwards, oval  
 curba por abajo, oval  
 curva in basso, ovale



 L = 8,0 cm, 3 1/8"

**27-409-01** 1,0 x 1,8 mm

rechts  
right  
derecha  
destra

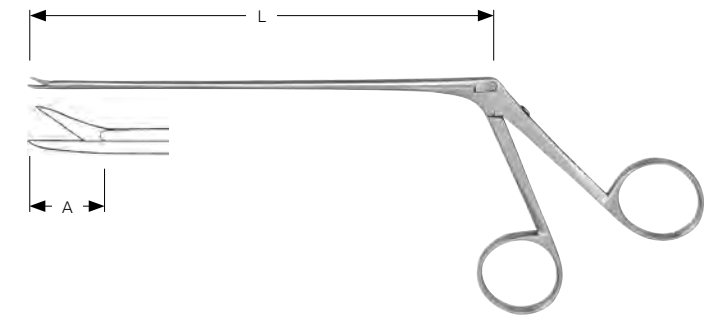
mit Rohrschaft  
with tubular shaft  
con vástago tubular  
con asta tubolare

 L = 8,0 cm, 3 1/8"

**27-409-02** 1,0 x 1,8 mm

links  
left  
izquierda  
sinistra

mit Rohrschaft  
with tubular shaft  
con vástago tubular  
con asta tubolare



  
 L = 12,5 cm, 5"

**BELLUCCI**

**27-412-11** A = 4,5 mm

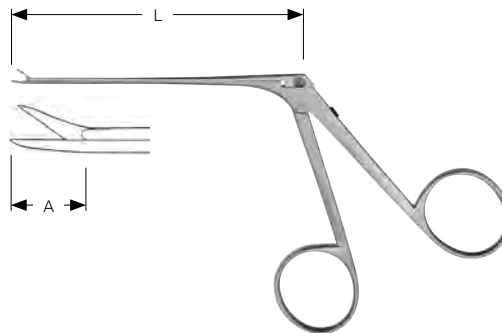
gerade  
straight  
recta  
retta

  
 L = 15,0 cm, 6"

**BELLUCCI**

**27-412-15** A = 4,5 mm

gerade  
straight  
recta  
retta



**BELLUCCI**

  
 L = 8,0 cm, 3 1/8"

**27-410-01** A = 8,0 mm

**27-412-01** A = 4,5 mm

**27-414-01** A = 3,5 mm

gerade  
straight  
recta  
retta

  
 L = 8,0 cm, 3 1/8"

**27-410-02** A = 6,0 mm

**27-412-02** A = 4,0 mm

aufgebogen  
curved upwards  
curva por arriba  
curva in alto

  
 L = 8,0 cm, 3 1/8"

**27-410-03** A = 8,0 mm

**27-412-03** A = 4,5 mm

**27-414-03** A = 3,5 mm

rechts  
right  
derecha  
destra

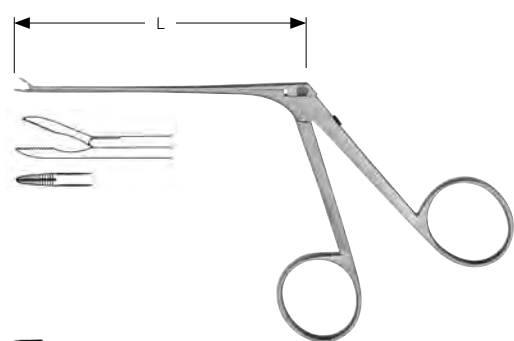
  
 L = 8,0 cm, 3 1/8"

**27-410-04** A = 8,0 mm

**27-412-04** A = 4,5 mm

**27-414-04** A = 3,5 mm

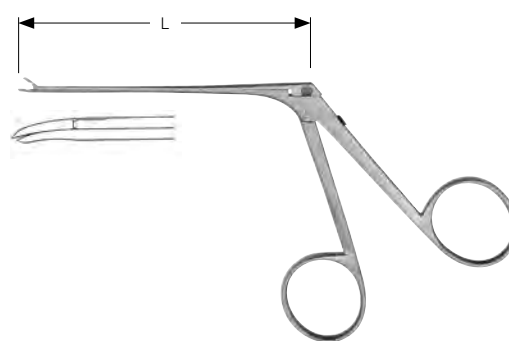
links  
left  
izquierda  
sinistra



### GREVEN

**27-420-01** 0,8 x 5,0 mm

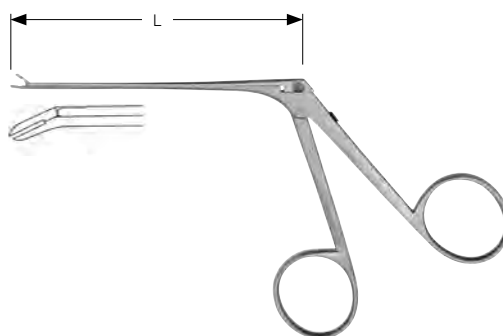
gerade  
 straight  
 recta  
 retta



### SCHUKNECHT

**27-420-02** 0,8 x 6,0 mm

abgebogen  
 curved downwards  
 curba por abajo  
 curva in basso



### MC GEE



**27-422-01** 0,8 x 3,5 mm

abgebogen  
 curved downwards  
 curba por abajo  
 curva in basso



**27-422-02** 0,8 x 5,5 mm

abgebogen  
 curved downwards  
 curba por abajo  
 curva in basso



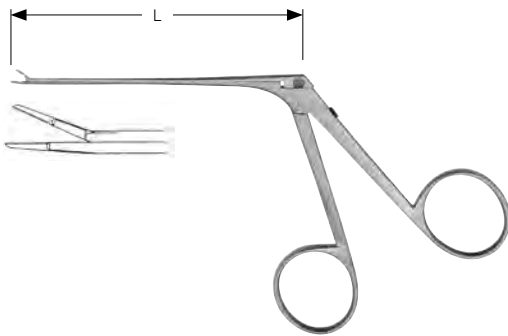
**27-422-03** 0,8 x 3,5 mm

rechts  
 right  
 derecha  
 destra



**27-422-04** 0,8 x 3,5 mm

links  
 left  
 izquierda  
 sinistra



### JUERS

**27-424-01** 8,0 cm, 3 1/8"

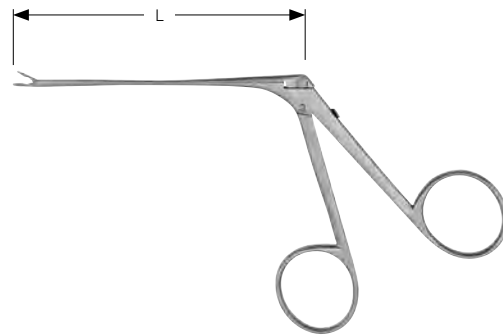
Drahtbiegezängchen, links  
Wire bending forceps, left  
Pinza para plegar alambre, izquierda  
Pinza per piegare fili metallici, sinistra



### JUERS

**27-424-02** 8,0 cm, 3 1/8"

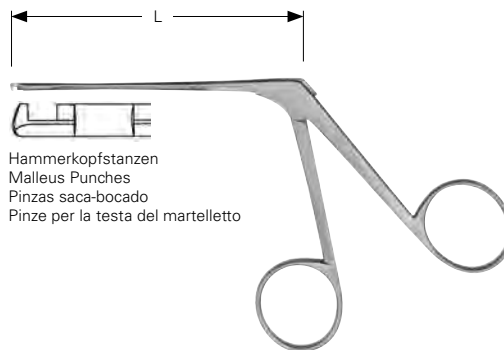
Drahtbiegezängchen, rechts  
Wire bending forceps, right  
Pinza para plegar alambre, derecha  
Pinza per piegare fili metallici, destra



### FULLER

**27-428-01** 8,0 cm, 3 1/8"

Einführungszängchen für Teflonprothesen  
Introducing forceps for teflon prosthesis  
Pinza para introducir para prótesis de teflon  
Pinza per introduzione per protesi in teflon



Hammerkopfstanzen  
Malleus Punches  
Pinzas saca-bocado  
Pinze per la testa del martelletto

### HOUSE-DIETER

 L = 8,0 cm, 3 1/8"

**27-426-01** 1,3 mm

unten schneidend  
down-cutting  
corte abajo  
tagliente in basso

 L = 8,0 cm, 3 1/8"

**27-426-02** 1,3 mm

oben schneidend  
up-cutting  
corte arriba  
tagliente in alto

 L = 8,0 cm, 3 1/8"

**27-426-03** 1,3 mm

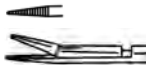
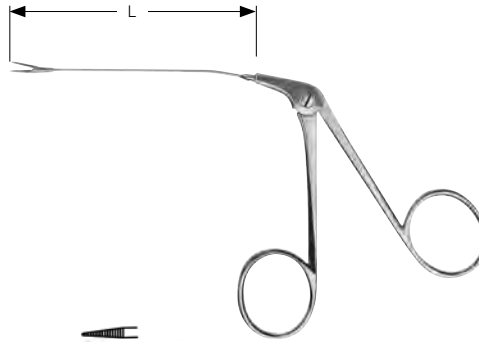
links schneidend  
left cutting  
corte izquierda  
tagliente a sinistra

 L = 8,0 cm, 3 1/8"

**27-426-04** 1,3 mm

rechts scheidend  
right cutting  
corte derecha  
tagliente a destra





L = 8,0 cm, 3 1/8"

- 27-450-01** 3,5 x 0,8 mm
- 27-450-02** 5,0 x 1,0 mm
- 27-450-03** 6,0 x 1,5 mm

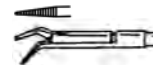
gerade  
straight  
recta  
retta

mit Rohrschaft  
with tubular shaft  
con vástago tubular  
con asta tubolare



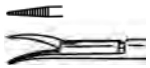
L = 8,0 cm, 3 1/8"

- 27-450-04** 3,5 x 0,8 mm
- aufgebogen  
curved upwards  
curba por arriba  
curva in alto
- mit Rohrschaft  
with tubular shaft  
con vástago tubular  
con asta tubolare



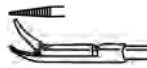
L = 8,0 cm, 3 1/8"

- 27-450-05** 3,5 x 0,8 mm
- abgebogen  
curved downwards  
curba por abajo  
curva in basso
- mit Rohrschaft  
with tubular shaft  
con vástago tubular  
con asta tubolare



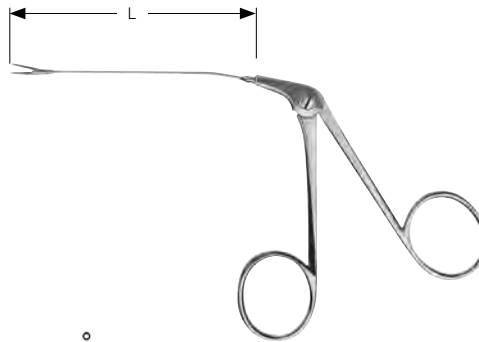
L = 8,0 cm, 3 1/8"

- 27-450-06** 5,0 x 1,0 mm
- links  
left  
izquierda  
sinistra
- mit Rohrschaft  
with tubular shaft  
con vástago tubular  
con asta tubolare



L = 8,0 cm, 3 1/8"

- 27-450-07** 5,0 x 1,0 mm
- links  
left  
izquierda  
sinistra
- mit Rohrschaft  
with tubular shaft  
con vástago tubular  
con asta tubolare



L = 8,0 cm, 3 1/8"

- 27-452-01** 0,9 x 1,0 mm
- 27-452-02** 0,8 x 1,3 mm
- 27-452-04** 1,7 x 2,5 mm

gerade, oval  
straight, oval  
recta, oval  
retta, ovale

mit Rohrschaft  
with tubular shaft  
con vástago tubular  
con asta tubolare



L = 8,0 cm, 3 1/8"

- 27-452-03** Ø 1,0 mm
- gerade, rund  
straight, round  
recta, redondo  
retta, rotondo
- mit Rohrschaft  
with tubular shaft  
con vástago tubular  
con asta tubolare



L = 8,0 cm, 3 1/8"

- 27-452-05** 0,9 x 1,0 mm
- aufgebogen, oval  
curved upwards, oval  
curba por arriba, oval  
curva in alto, ovale
- mit Rohrschaft  
with tubular shaft  
con vástago tubular  
con asta tubolare



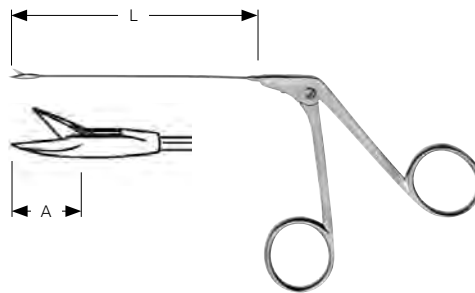
L = 8,0 cm, 3 1/8"

- 27-452-06** 0,8 x 1,3 mm
- links, oval  
left, oval  
izquierda, oval  
sinistra, ovale
- mit Rohrschaft  
with tubular shaft  
con vástago tubular  
con asta tubolare



L = 8,0 cm, 3 1/8"

- 27-452-07** 0,8 x 1,3 mm
- rechts, oval  
right, oval  
derecha, oval  
destra, ovale
- mit Rohrschaft  
with tubular shaft  
con vástago tubular  
con asta tubolare



**BELLUCCI**



L = 8,0 cm, 3 1/8"

**27-454-01** A = 4,0 mm

gerade  
straight  
recta  
retta

mit Rohrschaft  
with tubular shaft  
con vástago tubular  
con asta tubolare



L = 8,0 cm, 3 1/8"

**27-454-02** A = 4,0 mm

aufgebogen  
bent upwards  
curva por arriba  
curva in alto

mit Rohrschaft  
with tubular shaft  
con vástago tubular  
con asta tubolare



L = 8,0 cm, 3 1/8"

**27-454-03** A = 4,0 mm

links gebogen  
curved left  
curva a la izquierda  
curve verso sinistra

mit Rohrschaft  
with tubular shaft  
con vástago tubular  
con asta tubolare



L = 8,0 cm, 3 1/8"

**27-454-04** A = 4,0 mm

rechts gebogen  
curved right  
curva a la derecha  
curve verso destra

mit Rohrschaft  
with tubular shaft  
con vástago tubular  
con asta tubolare

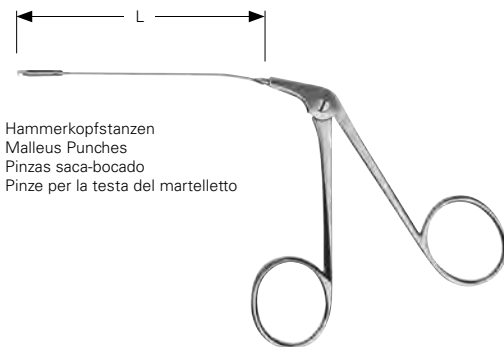


L = 8,0 cm, 3 1/8"

**27-454-05** A = 4,0 mm

horizontal schneidend  
horizontal cutting  
corte horizontal  
a taglio orizzontale

mit Rohrschaft  
with tubular shaft  
con vástago tubular  
con asta tubolare



Hammerkopfstanz  
Malleus Punches  
Pinzas saca-bocado  
Pinze per la testa del martelletto



L = 8,0 cm, 3 1/8"

**DIETER**

**27-454-06** 1,3 mm

oben schneidend  
up-cutting  
corte arriba  
tagliante in alto

mit Rohrschaft  
with tubular shaft  
con vástago tubular  
con asta tubolare



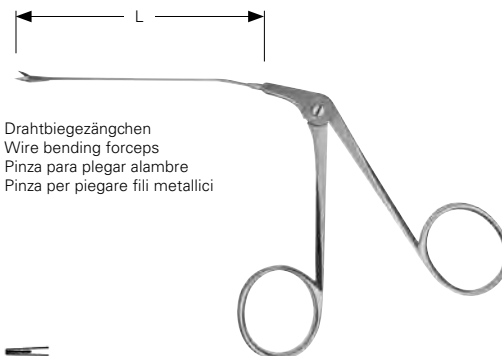
L = 8,0 cm, 3 1/8"

**DIETER**

**27-454-07** 1,3 mm

unten schneidend  
down-cutting  
corte abajo  
tagliante in basso

mit Rohrschaft  
with tubular shaft  
con vástago tubular  
con asta tubolare



Drahtbiegezängchen  
Wire bending forceps  
Pinza para plegar alambre  
Pinza per piegare fili metallici



L = 8,0 cm, 3 1/8"

**MC GEE**

**27-454-08** 0,8 x 3,5 mm

abgebogen  
curved downwards  
curva por abajo  
curva in basso

mit Rohrschaft  
with tubular shaft  
con vástago tubular  
con asta tubolare



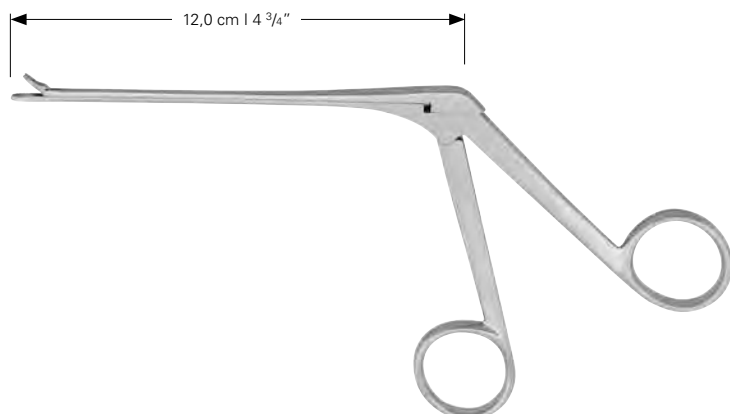
L = 8,0 cm, 3 1/8"

**MC GEE**

**27-454-09** 0,8 x 5,5 mm

abgebogen  
curved downwards  
curva por abajo  
curva in basso

mit Rohrschaft  
with tubular shaft  
con vástago tubular  
con asta tubolare



### WEIL-BLAKESLEY

<b>27-460-25</b>	2,5 mm
<b>27-460-36</b>	3,6 mm
<b>27-460-48</b>	4,8 mm

gerade, durchschneidend  
 straight, through cutting  
 recta, cortantes  
 retta, taglienti



### WEIL-BLAKESLEY

<b>27-461-25</b>	2,5 mm
<b>27-461-36</b>	3,6 mm
<b>27-461-48</b>	4,8 mm

aufgebogen 45°, durchschneidend  
 curved up 45°, through cutting  
 curva por arriba 45°, cortantes  
 curva in alto 45°, taglienti



#### 27-500-01

Diszisionsmesser  
 Discision knife  
 Cuchillo de discision  
 Bisturi da discissione



#### PLESTER

#### 27-500-02

Sichelmesser  
 Sickle knife  
 Cuchillo en forma de hoz  
 Bisturi falciforme



#### TABB

#### 27-500-04

Schleimhautmesser  
 Mucosa knife  
 Cuchillo para mucosa  
 Bisturi per mucosa



#### BEALES

#### 27-500-05

Sehnenmesser  
 Tendon knife  
 Cuchillo para el tendón  
 Bisturi per tendine



#### 27-500-06

Sichelmesser  
 Sickle knife  
 Cuchillo en forma de hoz  
 Bisturi falciforme



#### PLESTER

#### 27-500-12

Sichelmesser  
 Sickle knife  
 Cuchillo en forma de hoz  
 Bisturi falciforme



#### PLESTER

#### 27-500-13

Sichelmesser  
 Sickle knife  
 Cuchillo en forma de hoz  
 Bisturi falciforme



#### PLESTER

#### 27-500-15

Sichelmesser  
 Sickle knife  
 Cuchillo en forma de hoz  
 Bisturi falciforme



2,4 x 3,0 mm

#### PLESTER

#### 27-501-01

Lappenmesser  
 Flap knife  
 Cuchillo para lóbulos  
 Bisturi a falda



2,4 x 3,5 mm

#### PLESTER

#### 27-501-02

Lappenmesser  
 Flap knife  
 Cuchillo para lóbulos  
 Bisturi a falda

**27-500-01 - 27-502-02** 16,0 cm, 6 1/4"

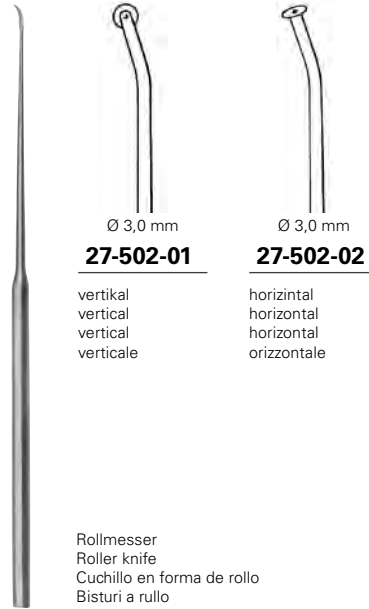


**27-500-03**

Sichelmesser  
Sickle knife  
Cuchillo en forma de hoz  
Bisturi falciforme

**SCHUKNECHT**

**27-500-03** 16,0 cm, 6 1/4"



Ø 3,0 mm

**27-502-01**

vertikal  
vertical  
vertical  
verticale

Ø 3,0 mm

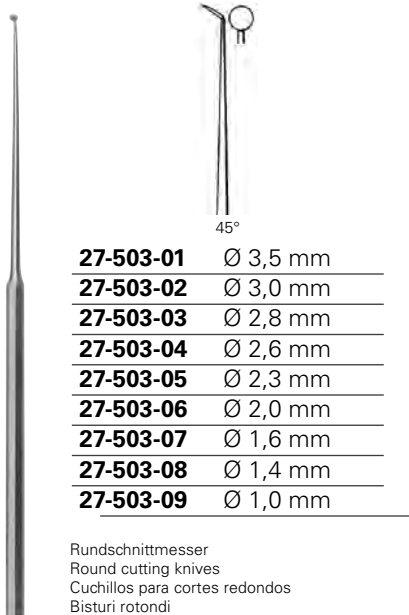
**27-502-02**

horizontal  
horizontal  
horizontal  
orizzontale

Rollmesser  
Roller knife  
Cuchillo en forma de rollo  
Bisturi a rullo

**SCHUKNECHT**

**27-502-01 - 27-502-02** 16,0 cm, 6 1/4"



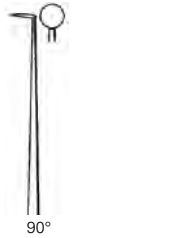
45°

- 27-503-01** Ø 3,5 mm
- 27-503-02** Ø 3,0 mm
- 27-503-03** Ø 2,8 mm
- 27-503-04** Ø 2,6 mm
- 27-503-05** Ø 2,3 mm
- 27-503-06** Ø 2,0 mm
- 27-503-07** Ø 1,6 mm
- 27-503-08** Ø 1,4 mm
- 27-503-09** Ø 1,0 mm

Rundschnittmesser  
Round cutting knives  
Cuchillos para cortes redondos  
Bisturi rotondi

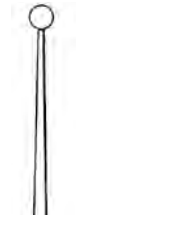
**ROSEN**

**27-503-01 - 27-503-28** 16,0 cm, 6 1/4"



90°

- 27-503-12** Ø 3,0 mm
- 27-503-13** Ø 2,5 mm
- 27-503-14** Ø 2,3 mm
- 27-503-15** Ø 2,0 mm
- 27-503-16** Ø 1,5 mm
- 27-503-18** Ø 1,0 mm



- 27-503-22** Ø 3,0 mm
- 27-503-23** Ø 2,5 mm
- 27-503-24** Ø 2,3 mm
- 27-503-25** Ø 2,0 mm
- 27-503-26** Ø 1,5 mm
- 27-503-28** Ø 1,0 mm




		3,0 x 2,0 mm	<b>ROSEN</b>	<b>27-503-43</b>	Lanzettenmesser, 45° Lancet knife, 45° Cuchillo lanceolado, 45° Bisturi lanceolato, 45°
		6,0 x 2,0 mm		<b>27-504-01</b>	Transplantat-Träger Graft holder Soporte para transplantes Supporto per trapiantazione
		12,0 x 1,0 mm	<b>HOUSE</b>	<b>27-504-02</b>	Raspatorium Raspatory Periostótomo Periostotomo
			<b>ROSEN</b>	<b>27-504-03</b>	Raspatorium Raspatory Periostótomo Periostotomo
			<b>ROSEN</b>	<b>27-504-04</b>	Raspatorium Raspatory Periostótomo Periostotomo
			<b>PLESTER</b>	<b>27-504-05</b>	Führungsgabel Wire guide Horquilla Forcella di guida
			<b>PLESTER</b>	<b>27-504-06</b>	Exkavator, links Excavator, left Excavador, izquierda Escavatore, sinistra
			<b>PLESTER</b>	<b>27-504-07</b>	Exkavator, rechts Excavator, right Excavador, derecha Escavatore, destra
		2,0 mm	<b>ROSEN</b>	<b>27-504-08</b>	Löffel Curette Cucharilla Cucchiola
		0,6 mm	<b>ROSEN</b>	<b>27-504-09</b>	Fenestrierhäkchen Fenestra hook Ganchito Gancio fenestrato

**27-503-43 - 57-504-09** 16,0 cm, 6 ¼ "


		1,8 mm	<b>ROSEN</b>	<b>27-504-10</b>	Raspatorium Raspatory Periostótomo Periostotomo
		0,4 mm   90°	<b>PLESTER</b>	<b>27-504-11</b>	Häkchen Hook Ganchito Uncino
				<b>27-504-12</b>	Häkchen Hook Ganchito Uncino
		0,8 mm   90°	<b>PLESTER</b>	<b>27-504-13</b>	Antrumahäkchen Antrum hook Ganchito para el seno maxilar Uncino per seno mascellare
		45°	<b>PLESTER</b>	<b>27-504-14</b>	Antrumahäkchen Antrum hook Ganchito para el seno maxilar Uncino per seno mascellare
			<b>HUGHES</b>	<b>27-504-15</b>	Steigbügelhäkchen Stirrup hook Ganchito de estribo Uncino per staffa
			<b>PLESTER</b>	<b>27-504-16</b>	Exkavator, links Excavator, left Excavador, izquierda Escavatore, sinistra
			<b>PLESTER</b>	<b>27-504-17</b>	Exkavator, rechts Excavator, right Excavador, derecha Escavatore, destra
			<b>PLESTER</b>	<b>27-504-18</b>	Exkavator, links Excavator, left Excavador, izquierda Escavatore, sinistra
			<b>PLESTER</b>	<b>27-504-19</b>	Exkavator, rechts Excavator, right Excavador, derecha Escavatore, destra

**27-504-10 - 27-504-19** 16,0 cm, 6 ¼ "



	0,2 mm   90°	3,5   4,0   4,5 mm		
<b>27-504-20</b>	<b>PLESTER</b>	<b>27-508-00</b>	<b>BARBARA</b>	<b>BARBARA</b>
Sichelmesser Sickle knife Cuchillo en forma de hoz Bisturi falciforme	Antrumhäkchen Antrum hook Ganchito para el seno maxilar Uncino per seno mascellare	Tiefenmeßsonde Measuring rod Sonda para medir Sonda con indicatore	Mikro-Nadel Micro needle Micro aguja Microaghi	Mikro-Nadel Micro needle Micro aguja Microaghi
<b>BARBARA</b>	<b>ROSEN</b>			
<b>27-510-03</b>	<b>27-510-04</b>			
Mikro-Nadel Micro needle Micro aguja Microaghi	Mikro-Nadel Micro needle Micro aguja Microaghi			


**27-504-20 - 27-510-04** 16,0 cm, 6 1/4"




2,0 mm		90°		
<b>PLESTER</b>	<b>BEALE</b>	<b>HOUSE</b>		
<b>27-510-17</b>	<b>27-510-64</b>	<b>27-506-35</b> L = 3,5 mm	<b>27-509-03</b> 0,3 mm	
Schaber, 60° Scraper, 60° Raspador, 60° Raspa, 60°	Häkchen Hook Ganchito Uncino	<b>27-506-40</b> L = 4,0 mm	<b>27-509-04</b> 0,4 mm	
		<b>27-506-45</b> L = 4,5 mm	<b>27-509-05</b> 0,5 mm	
		<b>27-506-50</b> L = 5,0 mm	<b>27-509-06</b> 0,6 mm	
		Mikro-Nadeln Micro needles Micro aguja Microaghi	Perforatoren Perforators Perforadores Perforatori	

**27-510-17 - 27-510-64** 16,0 cm, 6 1/4"


**27-506-35 - 27-509-06** 16,0 cm, 6 1/4"




25°

<b>27-510-05</b>	0,3 mm
<b>27-510-06</b>	0,6 mm
<b>27-510-07</b>	1,0 mm



45°

<b>27-510-08</b>	0,4 mm
<b>27-510-09</b>	0,6 mm
<b>27-510-10</b>	0,8 mm
<b>27-510-11</b>	1,0 mm
<b>27-510-18</b>	1,5 mm
<b>27-510-19</b>	2,0 mm
<b>27-510-20</b>	2,5 mm




90°


<b>27-510-12</b>	0,4 mm
<b>27-510-32</b>	0,5 mm
<b>27-510-13</b>	0,6 mm
<b>27-510-14</b>	0,8 mm
<b>27-510-15</b>	1,0 mm
<b>27-510-25</b>	1,2 mm
<b>27-510-26</b>	1,5 mm
<b>27-510-27</b>	2,0 mm
<b>27-510-28</b>	2,5 mm
<b>27-510-29</b>	3,0 mm
<b>27-510-30</b>	4,0 mm
<b>27-510-31</b>	5,0 mm

Mikro-Häkchen  
 Micro hooks  
 Micro ganchitos  
 Microuncini

## SHAMBAUGH

**27-510-05 - 27-510-32** 16,0 cm, 6 ¼"







0,5 mm

<b>27-510-21</b>	0,5 mm
<b>27-510-16</b>	1,0 mm


retrograd gebogen  
 curved retrograde  
 curvados retrogrados  
 curvi retrogradi

Mikro-Häkchen  
 Micro hooks  
 Micro ganchitos  
 Microuncini





**BARBARA**  
**27-514-01**



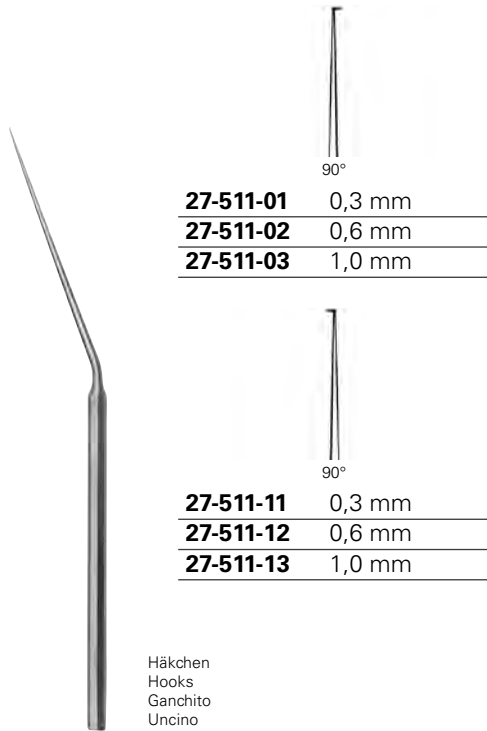
**ROSEN**  
**27-515-01**

Mikro-Nadeln  
 Micro needles  
 Micro aguja  
 Microaghi

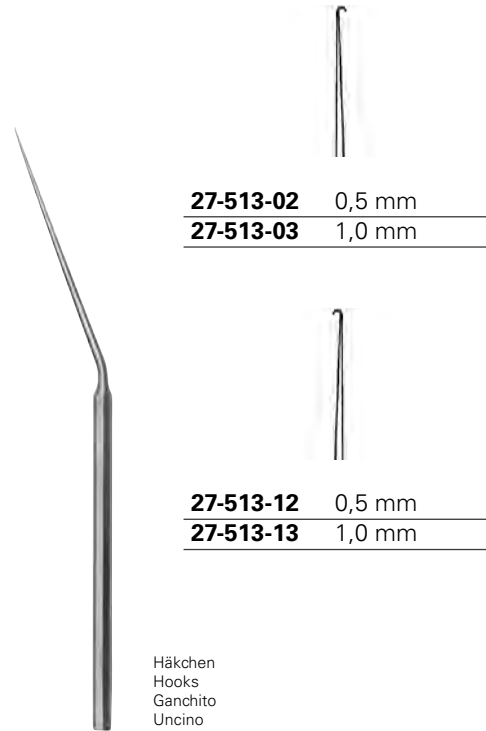
## SHAMBAUGH

**27-510-16 - 27-510-21** 16,0 cm, 6 ¼"

**27-514-01 - 27-515-01** 16,0 cm, 6 ¼"

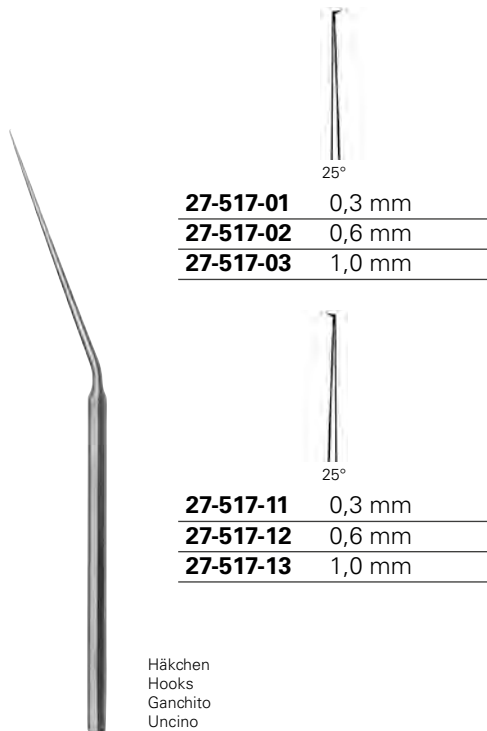


**27-511-01 - 27-511-13** 16,0 cm, 6 ¼"

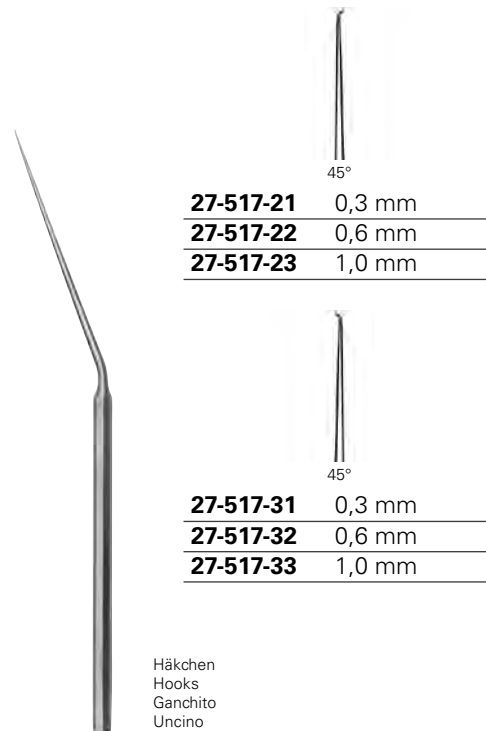


**MC GEE**

**27-513-02 - 27-513-13** 16,0 cm, 6 ¼"

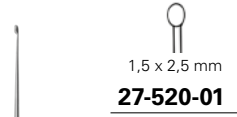


**27-517-01 - 27-517-13** 16,0 cm, 6 ¼"



**27-517-21 - 27-517-33** 16,0 cm, 6 ¼"



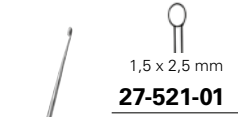


1,5 x 2,5 mm  
**27-520-01**

Scharfer Löffel  
 Sharp curette  
 Cucharilla cortantes  
 Cucchia taglienti

**SHEA**

**27-520-01** 16,0 cm, 6 1/4"

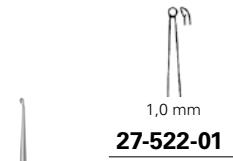


1,5 x 2,5 mm  
**27-521-01**

Scharfer Löffel  
 Sharp curette  
 Cucharilla cortantes  
 Cucchia taglienti

**SHEA**

**27-521-01** 16,0 cm, 6 1/4"



1,0 mm  
**27-522-01**

Scharfe Löffel  
 Sharp curettes  
 Cucharillas cortantes  
 Cucchia taglienti

**HOUSE**

**27-522-01 - 27-522-04** 16,0 cm, 6 1/4"



1,5 mm  
**27-522-02**



1,2 mm



1,8 mm



1,0 mm  
**27-522-03**



1,5 mm  
**27-522-04**



1,2 mm



1,8 mm



**27-530-01** 0,7 mm

Flachmeißel  
 Chisel  
 Cincel  
 Osteotomo

Handgriff für 27-530-01 - 27-530-05  
 Handle for 27-530-01 - 27-530-05  
 Mango para 27-530-01 - 27-530-05  
 Manico per 27-530-01 - 27-530-05



**27-530-02** 0,7 mm

**27-530-03** 1,0 mm

**27-530-04** 1,5 mm

**27-530-05** 3,0 mm

Hohlmeißel  
 Gouge  
 Gubia  
 Sgorbia



**HERMANN**

**27-529-00** 9,0 cm, 3 1/2"

**HERMANN**


**27-530-01 - 27-530-05** 9,0 cm, 3 1/2"












Metallhammer  
 Mallet, metal  
 Martillo  
 Martello

**HERMANN**

**27-532-19** 19,5 cm, 7 3/4"



						
	0,5 mm	0,5 mm	0,5 mm	0,5 mm	1,0 mm	1,0 mm
<b>27-540-00</b>	<b>27-540-01</b>	<b>27-540-02</b>	<b>27-540-03</b>	<b>27-540-04</b>	<b>27-540-05</b>	<b>27-540-06</b>
Mikro-Nadel Micro needle Micro aguja Microaghi	Häkchen, 45° Hook, 45° Ganchito, 45° Uncino, 45°	Häkchen, 45° Hook, 45° Ganchito, 45° Uncino, 45°	Häkchen, 90° Hook, 90° Ganchito, 90° Uncino, 90°	Häkchen, 90° Hook, 90° Ganchito, 90° Uncino, 90°	Häkchen, 45° Hook, 45° Ganchito, 45° Uncino, 45°	Häkchen, 45° Hook, 45° Ganchito, 45° Uncino, 45°
						
	1,0 mm	1,0 mm				
	<b>27-540-07</b>	<b>27-540-08</b>				
	Häkchen Hook Ganchito Uncino	Häkchen Hook Ganchito Uncino				

**ZOELLNER**

**27-540-00 - 27-540-08** 11,0 cm, 4 <sup>3</sup>/<sub>8</sub> "



						
<b>27-550-01</b>	<b>27-550-02</b>	<b>27-550-03</b>	<b>27-550-04</b>	<b>27-550-05</b>	<b>27-550-06</b>	<b>27-550-09</b>
Rundschnittmesser, 90° Round cutting knife, 90° Cuchillos para cortes redondos, 90° Bisturi rotondi, 90°		Sichelmesser Sickle knife Cuchillo en forma de hoz Bisturi falciforme		Lanzettenmesser Lancet knife Cuchillo lanceolado Bisturi lanceolato	Lanzettenmesser Lancet knife Cuchillo lanceolado Bisturi lanceolato	Führungsgabel Wire guide Horquilla Forcella di guida
						
	2,0 mm	2,0 mm				
	<b>27-550-07</b>	<b>27-550-08</b>				
Raspatorium, links Raspatory, left Periostotomo, izquierda Periostotomo, sinistra	Raspatorium, rechts Raspatory, right Periostotomo, derecha Periostotomo, destra					

**ZOELLNER**

**27-550-01 - 27-550-09** 11,0 cm, 4 <sup>3</sup>/<sub>8</sub> "



**27-553-16**

Dissektor, rechts  
 Dissector, right  
 Disector, derecha  
 Dissettore, destra



**27-554-16**

Dissektor, links  
 Dissector, left  
 Disector, izquierda  
 Dissettore, sinistra



45°

**27-555-16**

Rundschneidmesser  
 Round cutting knife  
 Cuchillos para cortes redondos  
 Bisturi rotondi



45°

**27-556-16**



**27-557-16**

Mikro-Nadel  
 Micro needle  
 Micro aguja  
 Microaghi



90°

**27-558-16**

Häkchen, stumpf  
 Hook, blunt  
 Ganchito, romo  
 Uncino, smusso



Handgriff für 27-553-16 - 27-558-16  
 Handle for 27-553-16 - 27-558-16  
 Mango para 27-553-16 - 27-558-16  
 Manico per 27-553-16 - 27-558-16



**27-553-16 - 27-558-16** 16,0 cm, 6 ¼"

**27-559-00**



**27-561-02** Ø 2,0 mm

**27-561-03** Ø 3,0 mm

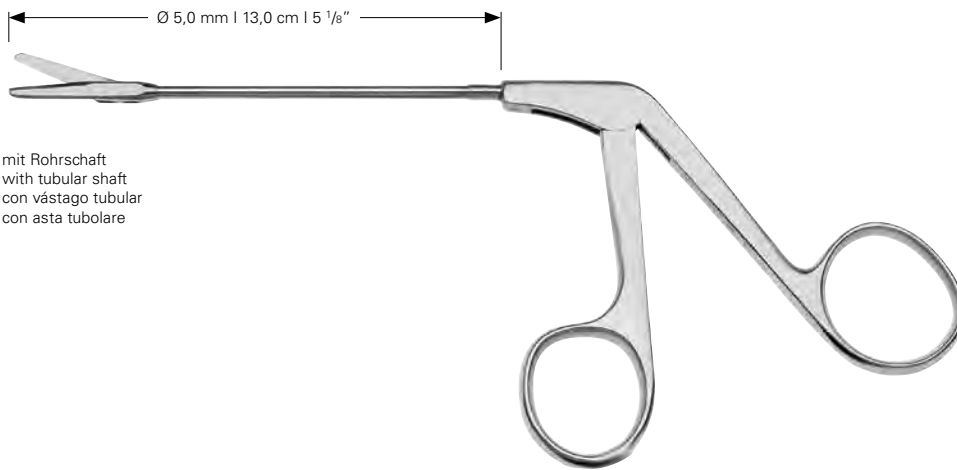
**27-561-04** Ø 4,0 mm

**27-561-05** Ø 5,0 mm

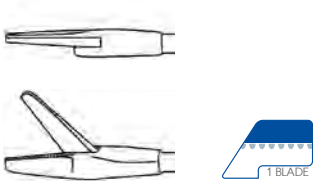
Stirnhöhlen-Dilatatoren  
 Frontal sinus bougies  
 Dilatadores para el seno frontal  
 Dilatatori per seno frontale

**RITTER**

**27-561-02 - 27-561-05** 16,0 cm, 6 ¼"

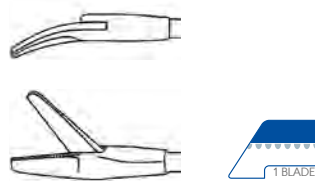


mit Rohrschaft  
with tubular shaft  
con vástago tubular  
con asta tubolare



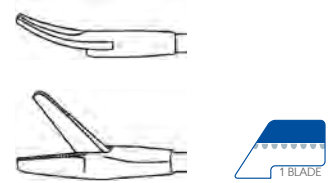
**27-600-00**

gerade  
straight  
recta  
retta



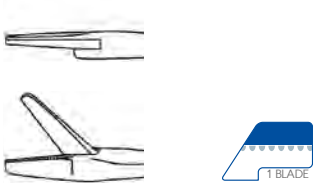
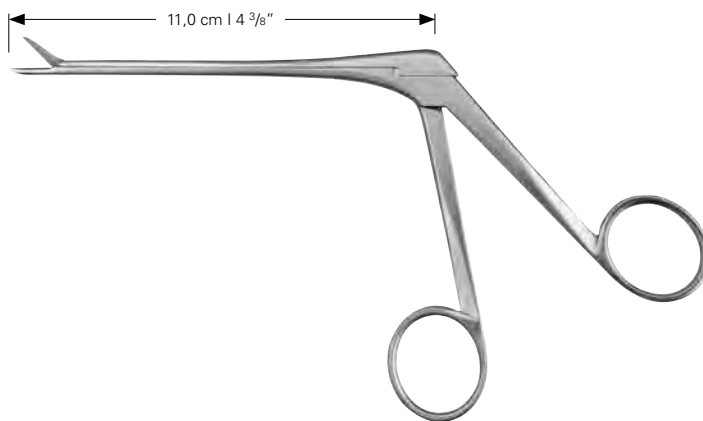
**27-600-01**

links gebogen  
cued left  
curva izquierda  
curva sinistra



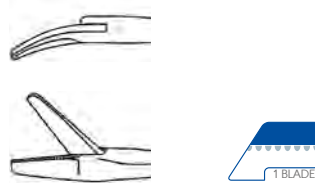
**27-600-02**

rechts gebogen  
cued right  
curva derecha  
curva destra



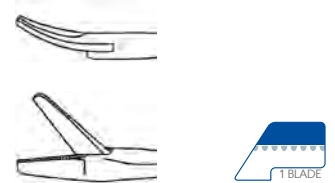
**27-600-10**

gerade  
straight  
recta  
retta



**27-600-11**

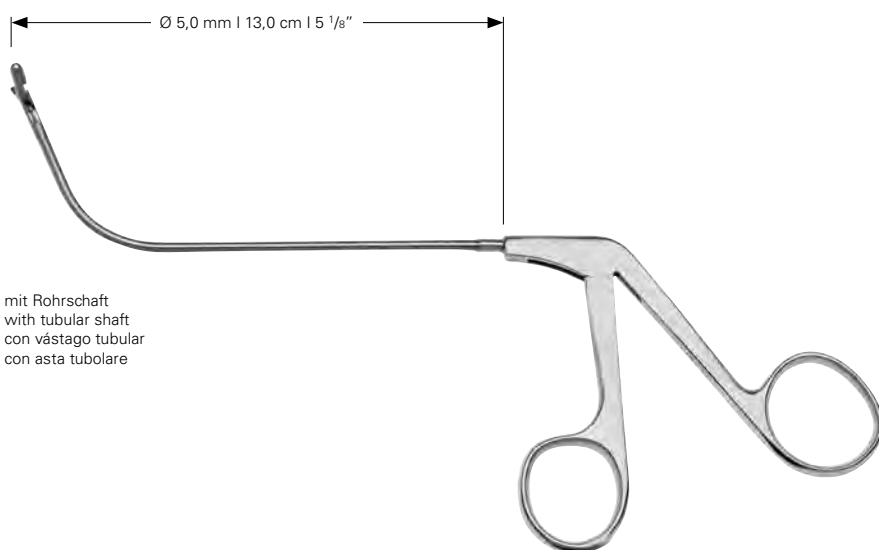
links gebogen  
cued left  
curva izquierda  
curva sinistra



**27-600-12**

rechts gebogen  
cued right  
curva derecha  
curva destra

Biopsienasenzangen  
 Biopsy nasal forceps  
 Pinzas nasales para biopsia  
 Pinze nasali per biopsia



mit Rohrschaft  
 with tubular shaft  
 con vástago tubular  
 con asta tubolare



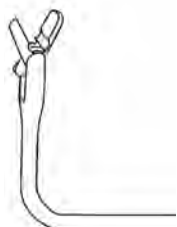
**27-610-03** 3,0 mm  
**27-610-04** 4,0 mm

70° aufgebogen, vertikal öffnend  
 70° curved upwards, vertical opening  
 70° curva hacia arriba, apertura vertical  
 70° curvo verso l'alto, apertura verticale



**27-611-03** 3,0 mm  
**27-611-04** 4,0 mm

70° aufgebogen, horizontal öffnend  
 70° curved upwards, horizontal opening  
 70° curva hacia arriba, apertura horizontal  
 70° curvo verso l'alto, apertura orizzontale



**27-612-03** 3,0 mm  
**27-612-04** 4,0 mm

90° aufgebogen, vertikal öffnend  
 90° curved upwards, vertical opening  
 90° curva hacia arriba, apertura vertical  
 90° curvo verso l'alto, apertura verticale



**27-613-03** 3,0 mm  
**27-613-04** 4,0 mm

90° aufgebogen, horizontal öffnend  
 90° curved upwards, horizontal opening  
 90° curva hacia arriba, apertura horizontal  
 90° curvo verso l'alto, apertura orizzontale



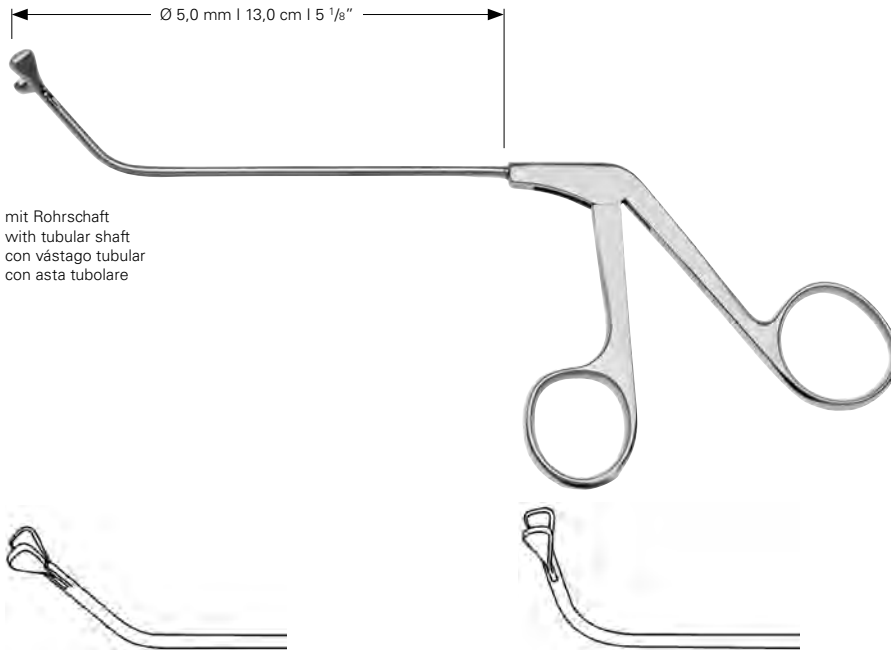
**27-614-03** 3,0 mm  
**27-614-04** 4,0 mm

110° aufgebogen, vertikal öffnend  
 110° curved upwards, vertical opening  
 110° curva hacia arriba, apertura vertical  
 110° curvo verso l'alto, apertura verticale



**27-615-03** 3,0 mm  
**27-615-04** 4,0 mm

110° aufgebogen, horizontal öffnend  
 110° curved upwards, horizontal opening  
 110° curva hacia arriba, apertura horizontal  
 110° curvo verso l'alto, apertura orizzontale



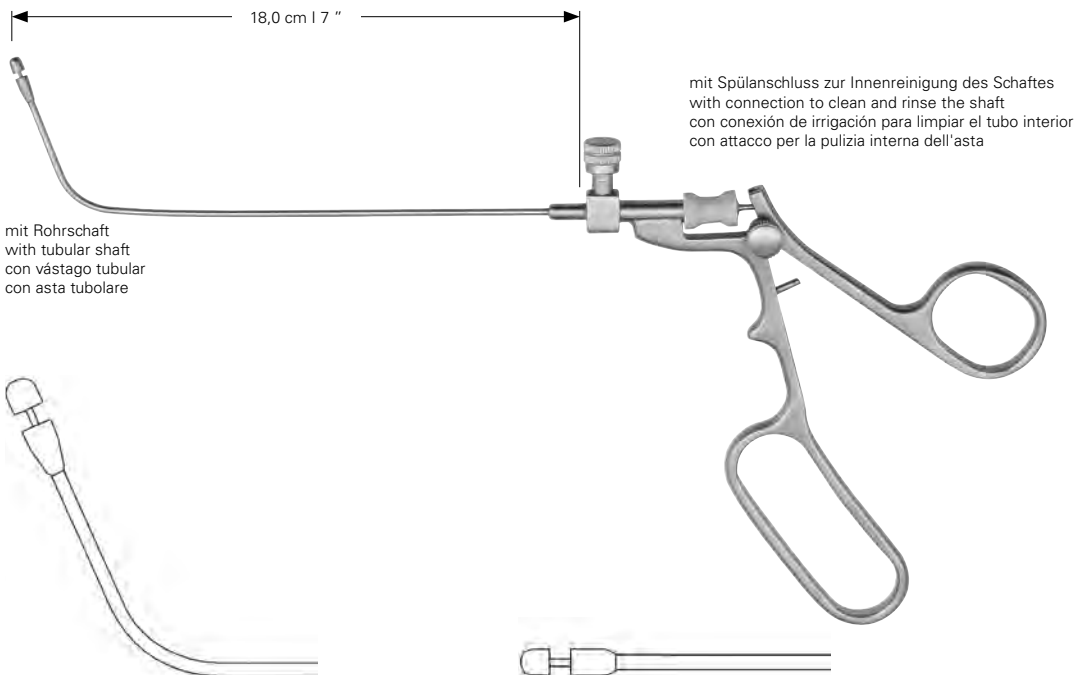
mit Rohrschaft  
with tubular shaft  
con vástago tubular  
con asta tubolare

**27-621-45**

45° aufgebogen, horizontal öffnend  
45° curved upwards, horizontal opening  
45° curva hacia arriba, horizontal vertical  
45° curvo verso l'alto, orizzontale verticale

**27-621-80**

80° aufgebogen, horizontal öffnend  
80° curved upwards, horizontal opening  
80° curva hacia arriba, horizontal vertical  
80° curvo verso l'alto, orizzontale verticale



mit Spülschluss zur Innenreinigung des Schaftes  
with connection to clean and rinse the shaft  
con conexión de irrigación para limpiar el tubo interior  
con attacco per la pulizia interna dell'asta

mit Rohrschaft  
with tubular shaft  
con vástago tubular  
con asta tubolare

**27-623-35** 3,5 mm

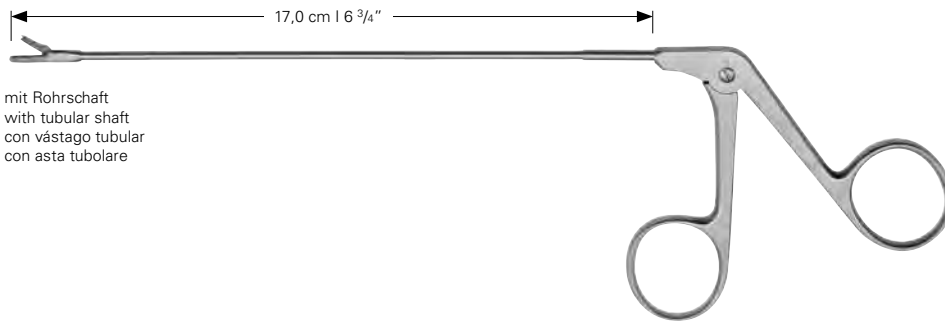
**27-623-45** 4,5 mm

65° aufgebogen, 360° zirkulär schneidend  
65° curved upwards, cutting in a full circle of 360°  
65° curva hacia arriba, corte circular a 360°  
65° curvo verso l'alto, angolo di taglio 360°

**27-622-35** 3,5 mm

**27-622-45** 4,5 mm

gerade, 360° zirkulär schneidend  
straight, cutting in a full circle of 360°  
retta, corte circular a 360°  
retta, angolo di taglio 360°



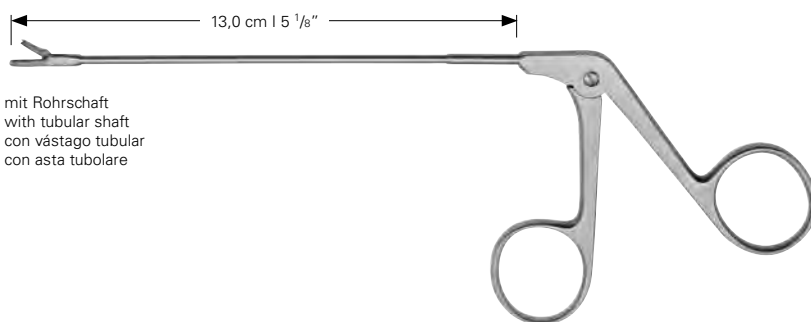
mit Rohrschaft  
with tubular shaft  
con vástago tubular  
con asta tubolare



### TAKAHASHI

**27-626-17**

gerade  
straight  
recta  
retta



mit Rohrschaft  
with tubular shaft  
con vástago tubular  
con asta tubolare



### BLAKESLEY

**27-628-00** 3,0 mm

**27-628-01** 3,5 mm

**27-628-02** 4,0 mm

gerade, durchschneidend  
straight, through cutting  
recta, cortantes  
retta, taglienti



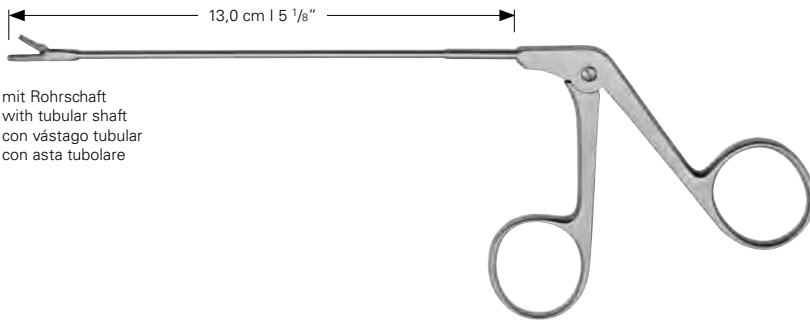
### BLAKESLEY

**27-629-00** 3,0 mm

**27-629-01** 3,5 mm

**27-629-02** 4,0 mm

aufgebogen 45°, durchschneidend  
curved up 45°, through cutting  
curva hacia arriba 45°, cortantes  
curvo verso l'alto 45°, taglienti



mit Rohrschaft  
with tubular shaft  
con vástago tubular  
con asta tubolare



**GRUENWALD**

**27-630-01** 8,0 x 3,0 mm  
**27-630-02** 12,0 x 3,0 mm

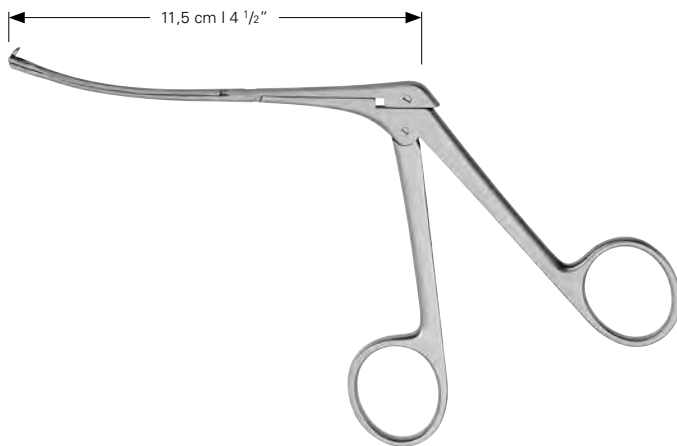
gerade, durchschneidend  
straight, through cutting  
recta, cortantes  
retta, taglienti



**GRUENWALD**

**27-631-01** 8,0 x 3,0 mm  
**27-631-02** 12,0 x 3,0 mm

aufgebogen 45°, durchschneidend  
curved up 45°, through cutting  
curva hacia arriba 45°, cortantes  
curvo verso l'alto 45°, taglienti



**27-655-01** 2,5 mm

abgebogen, rückwartsschneidend für Kinder  
curved downwards, retrograde cutting for children  
curva hacia abajo, corte retrógrado para niños  
curvo verso basso, tagliente retrograda per bambini



**27-655-03** 3,6 mm

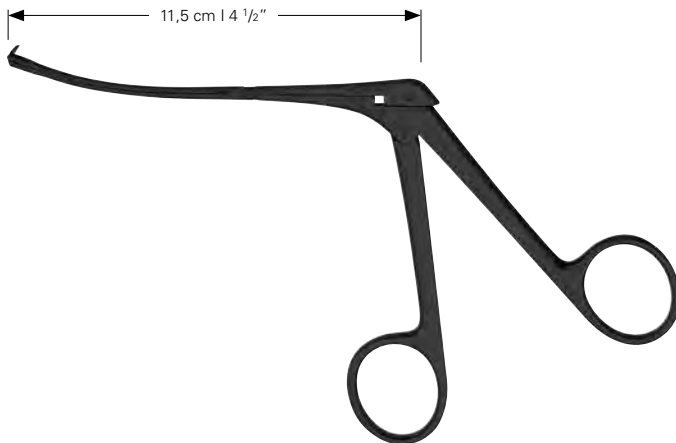
abgebogen, rückwartsschneidend für Erwachsene  
curved downwards, retrograde cutting for adults  
curva hacia abajo, corte retrógrado para adultos  
curvo verso basso, tagliente retrograda per adulti



**27-655-02** 2,5 mm

aufgebogen, rückwartsschneidend für Kinder  
curved upwards, retrograde cutting for children  
curva hacia arriba, corte retrógrado para niños  
curvo verso l'alto, tagliente retrograda per bambini





**27-655-01 B** 2,5 mm

abgebogen, rückwartsschneidend für Kinder  
curved downwards, retrograde cutting for children  
curva hacia abajo, corte retrógrado para niños  
curvo verso basso, tagliente retrograda per bambini



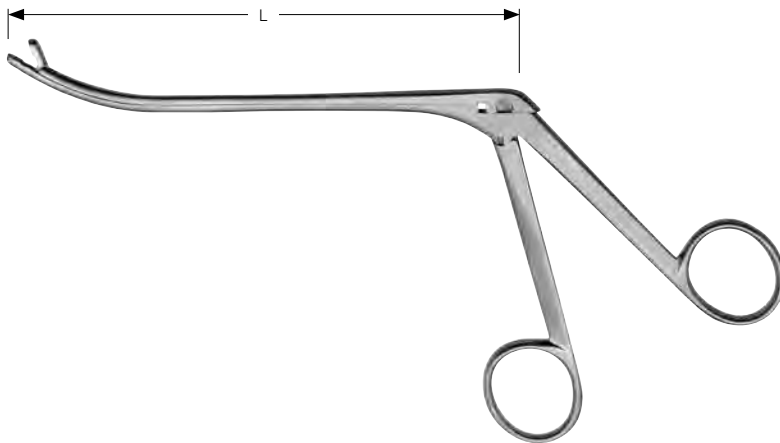
**27-655-03 B** 3,6 mm

abgebogen, rückwartsschneidend für Erwachsene  
curved downwards, retrograde cutting for adults  
curva hacia abajo, corte retrógrado para adultos  
curvo verso basso, tagliente retrograda per adulti



**27-655-02 B** 2,5 mm

aufgebogen, rückwartsschneidend für Kinder  
curved upwards, retrograde cutting for children  
curva hacia arriba, corte retrógrado para niños  
curvo verso l'alto, tagliente retrograda per bambini



**JIKEI**

**27-650-04** 14,0 cm, 5 1/2"

Fig. 4, gerade, fein, oval  
Fig. 4, straight, delicate, oval  
Fig. 4, recta, fina, oval  
Fig. 4, rette, fine, ovale



**JIKEI**

**27-650-05** 14,0 cm, 5 1/2"

Fig. 5, aufgebogen, fein, oval  
Fig. 5, curved up, delicate, oval  
Fig. 6, curva hacia arriba, fina, oval  
Fig. 5, curvo verso l'alto, fine, ovale



**JIKEI**

**27-650-01** 14,0 cm, 5 1/2"

Fig. 1, gerade, fein, durchschneidend  
Fig. 1, straight, delicate, through cutting  
Fig. 1, recta, fina, cortantes  
Fig. 1, rette, fine, taglienti



**JIKEI**

**27-650-02** 14,0 cm, 5 1/2"

Fig. 2, aufgebogen, fein, durchschneidend  
Fig. 2, curved up, delicate, through cutting  
Fig. 2, curva hacia arriba, fina, cortantes  
Fig. 2, curvo verso l'alto, fine, taglienti



**JIKEI**

**27-650-03** 14,0 cm, 5 1/2"

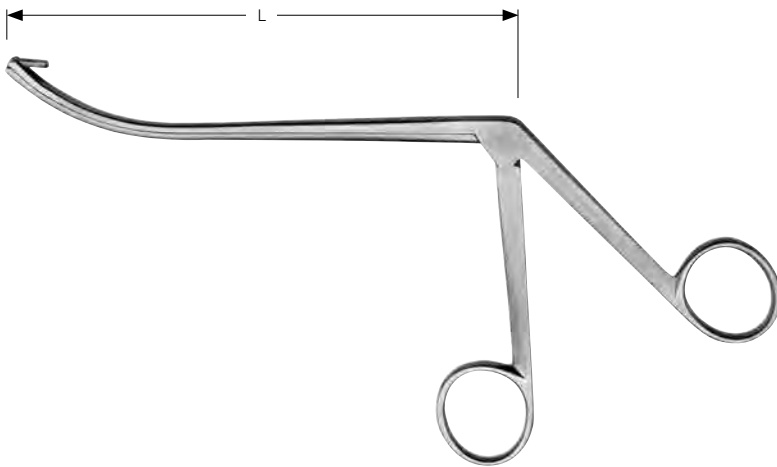
Fig. 3, aufgebogen, fein, durchschneidend  
Fig. 3, curved up, delicate, through cutting  
Fig. 3, curva hacia arriba, fina, cortantes  
Fig. 3, curvo verso l'alto, fine, taglienti



**JIKEI**

**27-650-06** 14,0 cm, 5 1/2"

Fig. 6, aufgebogen, fein, oval  
Fig. 6, curved up, delicate, oval  
Fig. 6, curva hacia arriba, fina, oval  
Fig. 6, curvo verso l'alto, fine, ovale



**JIKEI**

**27-650-07** 14,0 cm, 5 ½ "

Fig. 7, aufgebogen, rückwartsschneidend  
Fig. 7, curved up, retrograde cutting  
Fig. 7, curva hacia arriba, corte retrógrado  
Fig. 7, curvo verso l'alto, tagliente retrograda



**JIKEI**

**27-650-08** 14,0 cm, 5 ½ "

Fig. 8, aufgebogen, durchschneidend  
Fig. 8, curved up, through cutting  
Fig. 8, curva hacia arriba, cortantes  
Fig. 8, curvo verso l'alto, taglienti



**JIKEI**

**27-650-09** 14,0 cm, 5 ½ "

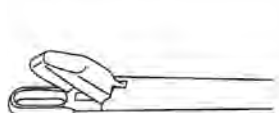
Fig. 9, aufgebogen, oval  
Fig. 9, curved up, oval  
Fig. 9, curva hacia arriba, oval  
Fig. 9, curvo verso l'alto, ovale



**JIKEI**

**27-650-10** 11,5 cm, 4 ½ "

Fig. 10, gerade, klein, durchschneidend  
Fig. 10, straight, small, through cutting  
Fig. 10, recta, pequeño, cortantes  
Fig. 10, rette, piccolo, taglienti



**JIKEI**

**27-650-11** 11,5 cm, 4 ½ "

Fig. 11, gerade, groß, durchschneidend  
Fig. 11, straight, large, through cutting  
Fig. 11, recta, grande, cortantes  
Fig. 11, rette, grande, taglienti



**JIKEI**

**27-650-12** 11,5 cm, 4 ½ "

Fig. 12, aufgebogen, klein, durchschneidend  
Fig. 12, curved up, small, through cutting  
Fig. 12, curva hacia arriba, pequeño, cortantes  
Fig. 12, curvo verso l'alto, piccolo, taglienti



**JIKEI**

**27-650-13** 11,5 cm, 4 ½ "

Fig. 13, aufgebogen, mittel, durchschneidend  
Fig. 13, curved up, medium, through cutting  
Fig. 13, curva hacia arriba, medio, cortantes  
Fig. 13, curvo verso l'alto, medio, taglienti



**JIKEI**

**27-650-14** 11,5 cm, 4 ½ "

Fig. 14, aufgebogen, groß, durchschneidend  
Fig. 14, curved up, large, through cutting  
Fig. 14, curva hacia arriba, grande, cortantes  
Fig. 14, curvo verso l'alto, grande, taglienti



## GRUENWALD

**27-660-00** SET

Komplett in Ständer, bestehend aus:

Complete in rack, consisting of:

1 Kanüle, gerade	<b>27-660-01</b>	1 Cannula, straight	<b>27-660-01</b>
1 Kanüle, abgebogen	<b>27-660-02</b>	1 Cannula, curved down	<b>27-660-02</b>
1 Kanüle, aufgebogen	<b>27-660-03</b>	1 Cannula, curved up	<b>27-660-03</b>
3 Glasflakons	<b>27-660-04</b>	3 Flasks	<b>27-660-04</b>

Completo en soporte, compuesto de:

Completo con supporto, composto da:

1 Cánula, recta	<b>27-660-01</b>	1 Cannula, retta	<b>27-660-01</b>
1 Cánula, hacia abajo	<b>27-660-02</b>	1 Cannula, curva in basso	<b>27-660-02</b>
1 Cánula, hacia arriba	<b>27-660-03</b>	1 Cannula, curva in alto	<b>27-660-03</b>
3 Frascons	<b>27-660-04</b>	3 Bottiglie	<b>27-660-04</b>



## GRUENWALD

**27-660-05**

Halbgebläse  
Rubber bulb  
Pera de goma  
Pera di gomma



## GRUENWALD

**27-660-04**

Ersatzglas  
Spare flask  
Frasquito de repuesto  
Bottiglia di ricambio



30

Thorax, Lunge

Thorax, Lung

Thoráció, Pulmòn

Thorace, Pulmone





**30-100-23** 23,0 cm, 9 "



**30-101-22** 23,0 cm, 9 "



**GLUCK**

**30-103-22** 22,0 cm, 8 ¾ "



**SCHUMACHER**

**30-106-21** 22,0 cm, 8 ¾ "



**LEBSCHKE**

**30-109-24** 24,0 cm, 9 ½ "



### SAUERBRUCH

**30-110-24** 24,0 cm, 9 ½"  
**30-110-27** 27,0 cm, 10 ¾"



### BETHUNE

**30-111-34** 34,0 cm, 13 ⅓"

links  
left  
izquierda  
sinistra



**CORYLLOS**

**30-111-35** 35,0 cm, 13 3/4"

rechts  
right  
derecha  
destra



**CORYLLOS**

**30-111-36** 35,0 cm, 13 3/4"





**SAUERBRUCH-FREY**

**30-112-37** 37,0 cm, 14 ½"



**GIERTZ-STILLE**

**30-117-27** 27,0 cm, 10 ¾"

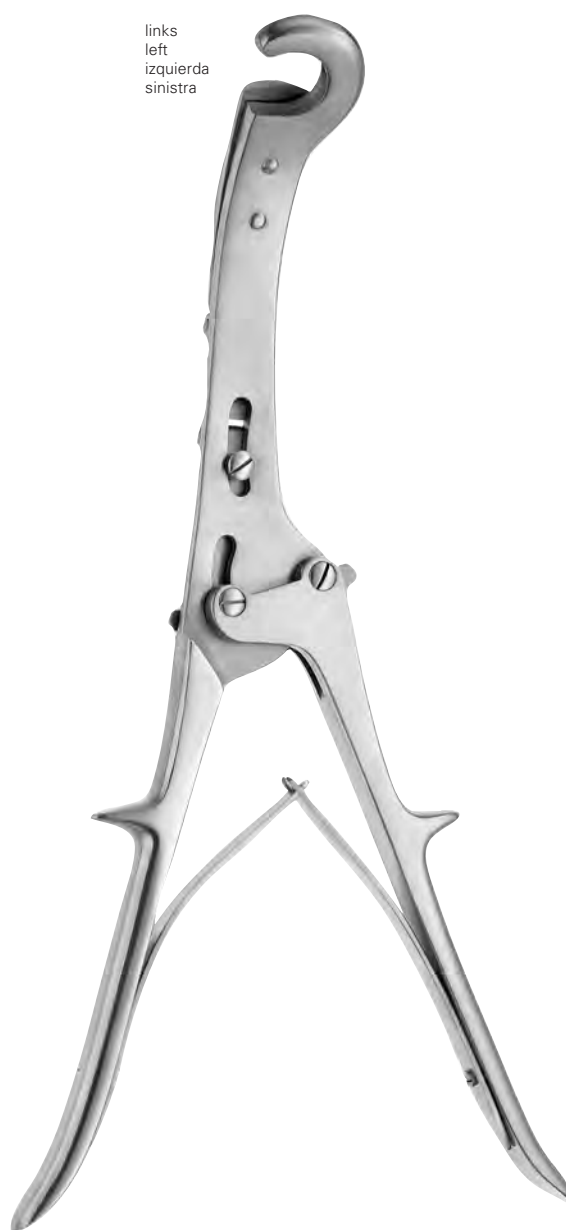
rechts  
right  
derecha  
destra



**BRUNNER**

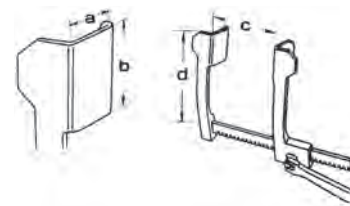
**30-113-28** 32,0 cm, 12 1/2"

links  
left  
izquierda  
sinistra



**BRUNNER**

**30-115-28** 32,0 cm, 12 1/2"



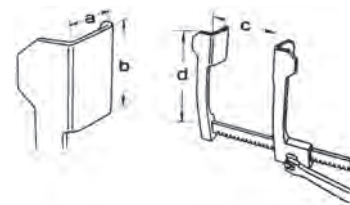
für Säuglinge  
 for infants  
 para bebés  
 per neonati

**COOLEY**



a b c d

<b>30-201-00</b>	14,0 mm	16,0 mm	85,0 mm	55,0 mm
------------------	---------	---------	---------	---------



für Kinder  
 for children  
 para niños  
 per bambini

**COOLEY**



a b c d

<b>30-202-00</b>	15,0 mm	30,0 mm	115,0 mm	80,0 mm
<b>30-202-01</b>	15,0 mm	30,0 mm	140,0 mm	80,0 mm



für Erwachsene  
 for adults  
 para adultos  
 per adulti

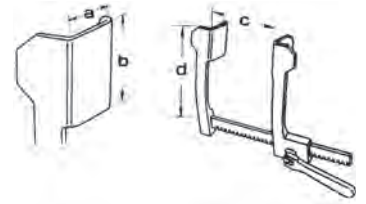
**COOLEY**

a

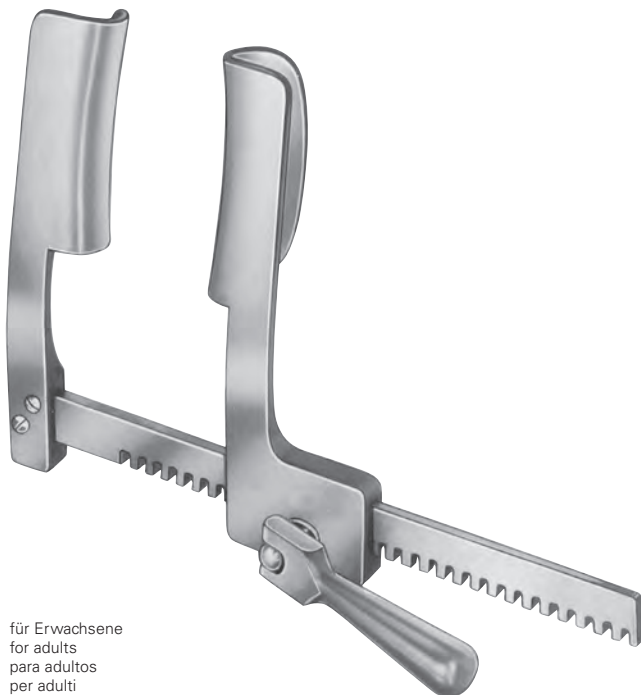
b

c

d



<b>30-203-00</b>	20,0 mm	45,0 mm	140,0 mm	110,0 mm
<b>30-204-00</b>	30,0 mm	50,0 mm	185,0 mm	145,0 mm



für Erwachsene  
 for adults  
 para adultos  
 per adulti

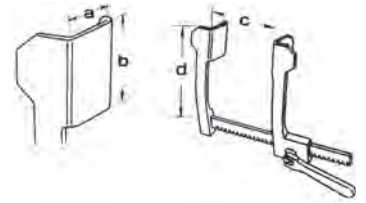
**COOLEY**

a

b

c

d

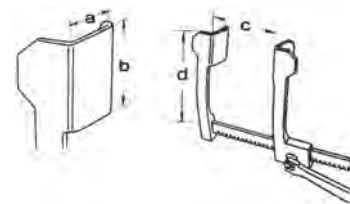


<b>30-204-10</b>	35,0 mm	100,0 mm	180,0 mm	180,0 mm
<b>30-204-30</b>	35,0 mm	115,0 mm	230,0 mm	205,0 mm



mit Fadenfänger  
 with suture separator  
 con sepeator de la sutura  
 con sepeator de suture

für Erwachsene  
 for adults  
 para adultos  
 per adulti

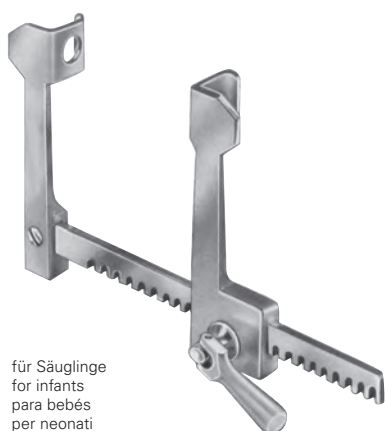
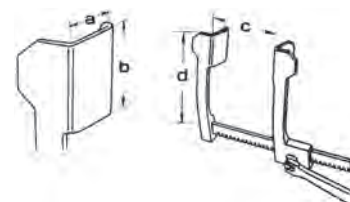


## COOLEY



a b c d

<b>30-204-20</b>	35,0 mm	100,0 mm	180,0 mm	180,0 mm
------------------	---------	----------	----------	----------



für Säuglinge  
 for infants  
 para bebés  
 per neonati

## FINOCHIETTO



a b c d

<b>30-205-00</b>	12,0 mm	15,0 mm	70,0 mm	55,0 mm
<b>30-205-01</b>	12,0 mm	15,0 mm	100,0 mm	55,0 mm



für Kinder  
 for children  
 para niños  
 per bambini

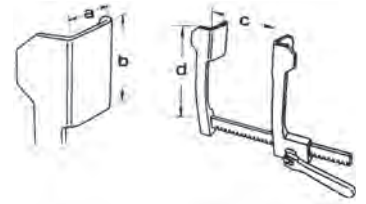
**FINOCHIETTO**

a

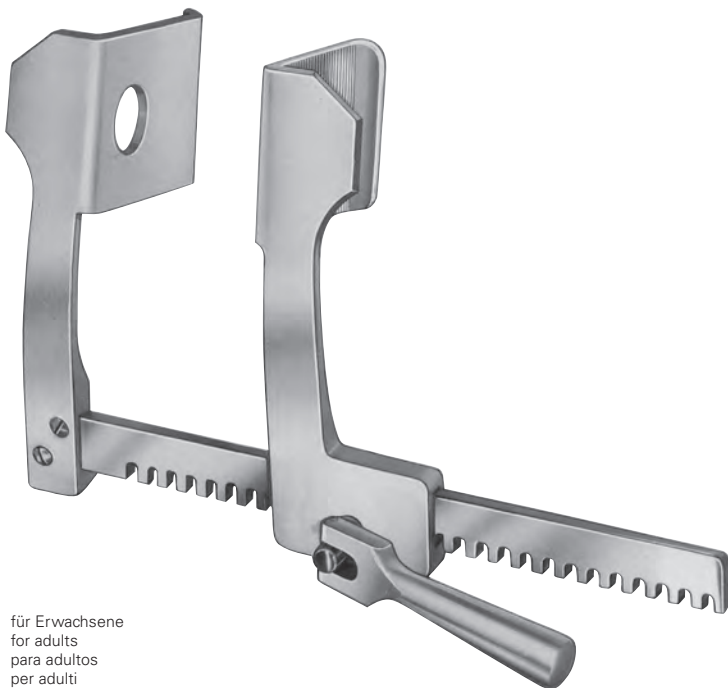
b

c

d



<b>30-206-00</b>	27,0 mm	30,0 mm	95,0 mm	80,0 mm
<b>30-207-00</b>	30,0 mm	45,0 mm	140,0 mm	110,0 mm



für Erwachsene  
 for adults  
 para adultos  
 per adulti

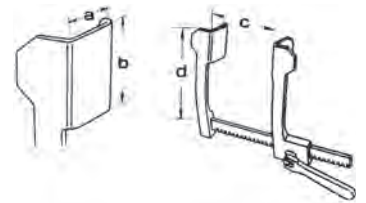
**FINOCHIETTO**

a

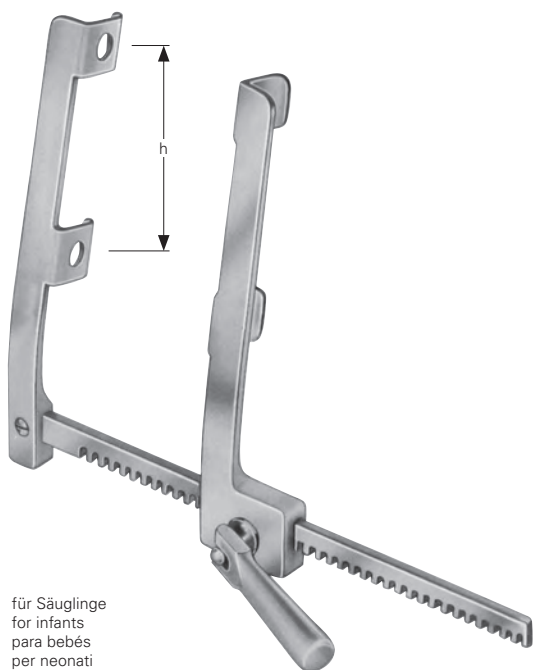
b

c

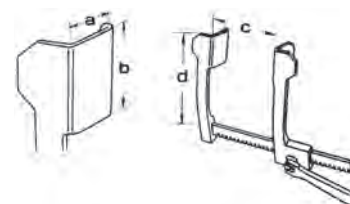
d



<b>30-208-00</b>	42,0 mm	62,0 mm	170,0 mm	140,0 mm
<b>30-209-00</b>	73,0 mm	65,0 mm	170,0 mm	140,0 mm



für Säuglinge  
 for infants  
 para bebés  
 per neonati



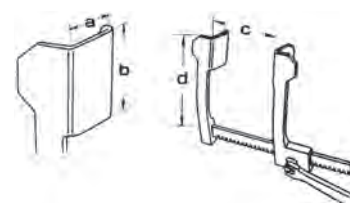
### FINOCHIETTO (modif.)



	h	a	b	c	d
<b>30-210-00</b>	40,0 mm	10,0 mm	15,0 mm	120,0 mm	105,0 mm



für Säuglinge  
 for infants  
 para bebés  
 per neonati



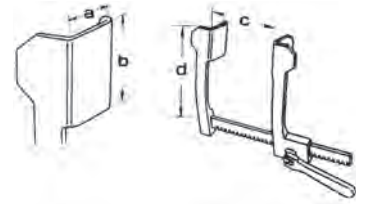
### CASTANEDA



	a	b	c	d
<b>30-211-00</b>	10,0 mm	30,0 mm	65,0 mm	55,0 mm
<b>30-212-00</b>	12,0 mm	45,0 mm	72,0 mm	80,0 mm



für Kinder  
 for children  
 para niños  
 per bambini

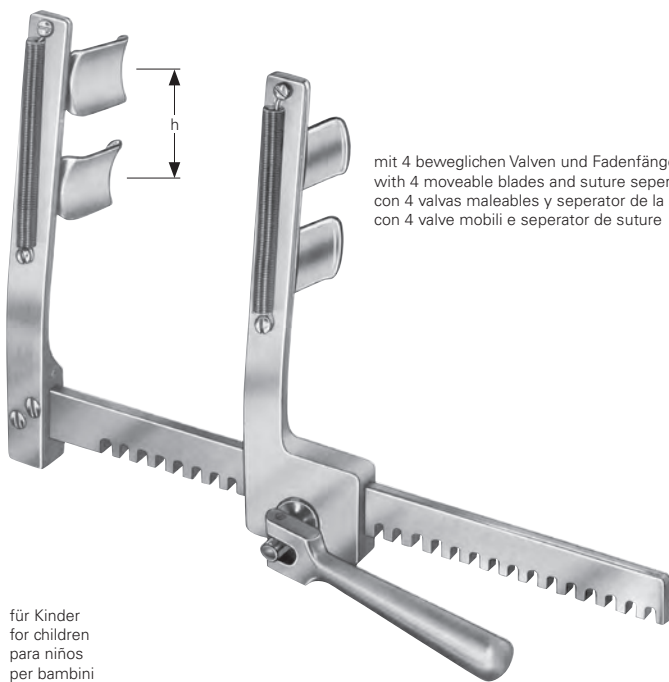


**CASTANEDA**

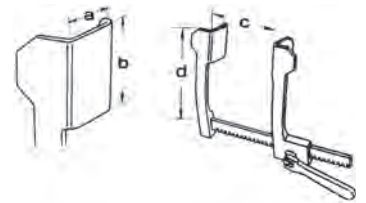


a b c d

<b>30-213-00</b>	15,0 mm	60,0 mm	100,0 mm	125,0 mm
------------------	---------	---------	----------	----------



mit 4 beweglichen Valven und Fadenfänger  
 with 4 moveable blades and suture separator  
 con 4 valvas maleables y sepeator de la sutura  
 con 4 valve mobili e sepeator de sutura



für Kinder  
 for children  
 para niños  
 per bambini

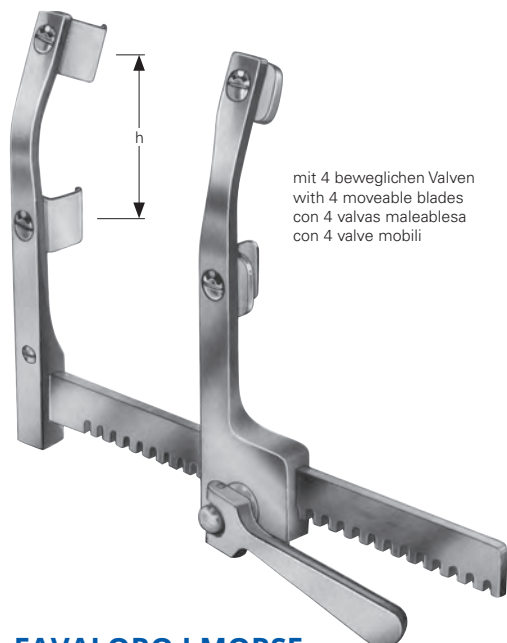
**ANKENEV**



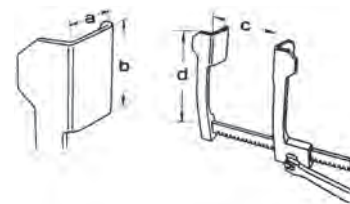
h a b c d

<b>30-214-00</b>	30,0 mm	20,0 mm	20,0 mm	160,0 mm	115,0 mm
------------------	---------	---------	---------	----------	----------





mit 4 beweglichen Valven  
 with 4 moveable blades  
 con 4 valvas maleablesa  
 con 4 valve mobili



30-215-00 - 30-216-00 für Kinder  
 for children  
 para niños  
 per bambini

30-217-00 - 30-218-00 für Erwachsene  
 for adults  
 para adultos  
 per adulti

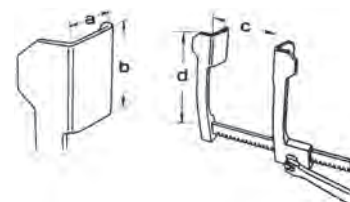
### FAVALORO I MORSE



	h	a	b	c	d
<b>30-215-00</b>	50,0 mm	17,0 mm	22,0 mm	160,0 mm	120,0 mm
<b>30-216-00</b>	50,0 mm	20,0 mm	20,0 mm	155,0 mm	120,0 mm
<b>30-217-00</b>	65,0 mm	40,0 mm	20,0 mm	155,0 mm	175,0 mm
<b>30-218-00</b>	72,0 mm	40,0 mm	28,0 mm	210,0 mm	155,0 mm

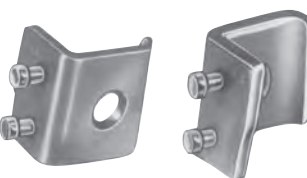


mit 2 Paar Valven (V1 | V2)  
 with 2 pairs of valves (V1 | V2)  
 con 2 pares de valvas (V1 | V2)  
 con 2 paia de valve (V1 | V2)



für Kinder  
 for children  
 para niños  
 per bambini

### BURFORD



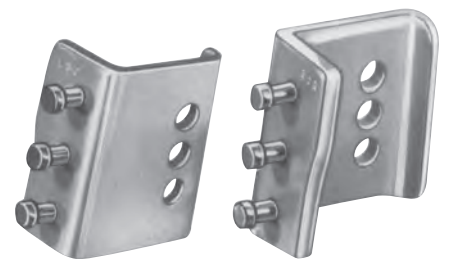
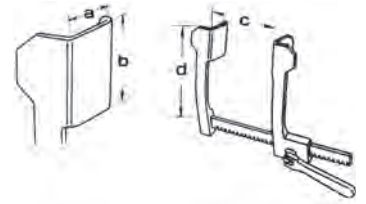
### BURFORD

**30-222-10** V1 30 x 42 mm  
**30-222-11** V2 41 x 42 mm

Valvenpaar  
 Pairs of valves  
 Pares de valvas  
 paia di valve



	a		b		c	d
	V1	V2	V1	V2		
<b>30-222-00</b>	30,0 mm	41,0 mm	42,0 mm	42,0 mm	130,0 mm	117,0 mm



für Erwachsene  
 for adults  
 para adultos  
 per adulti

**BURFORD**

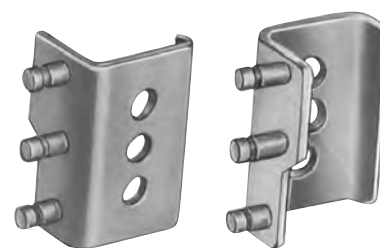
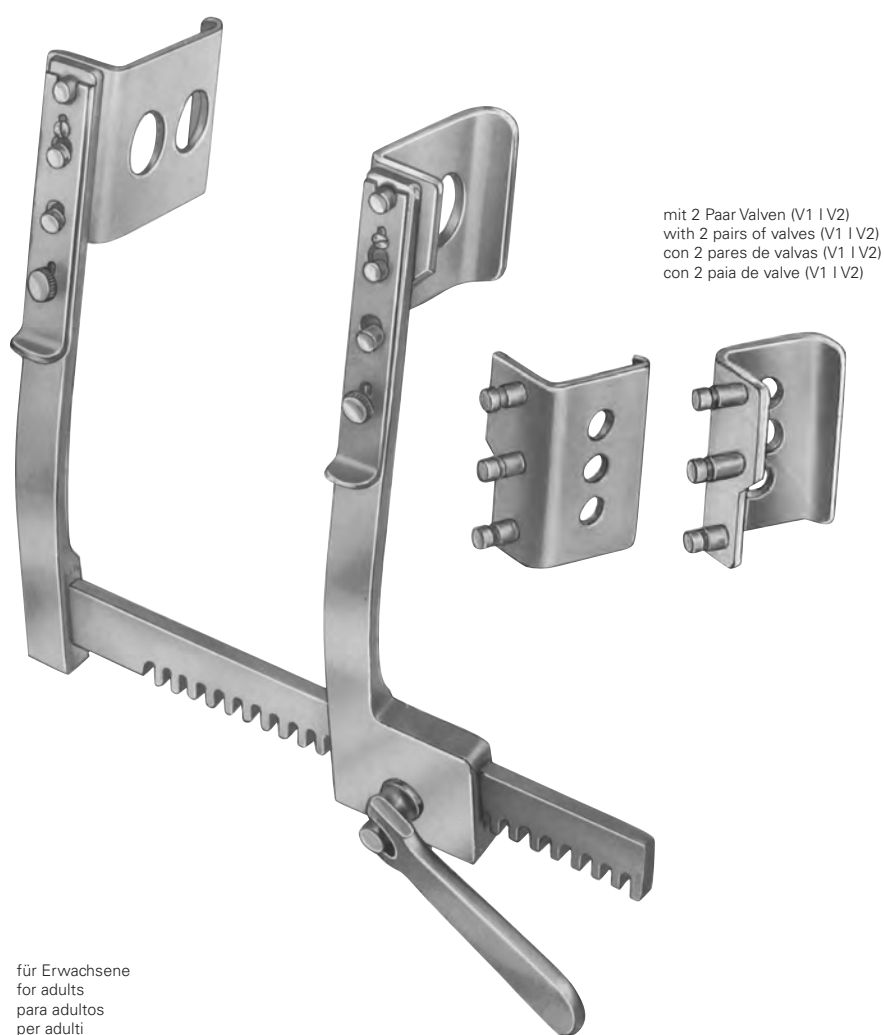
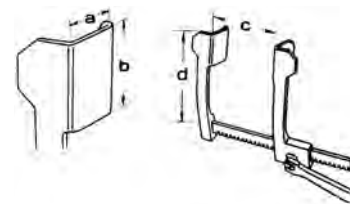
- 30-225-10** V1 45 x 62 mm
- 30-225-11** V2 65 x 62 mm

Valvenpaar  
 Pairs of valves  
 Pares de valvas  
 paia di valve

**BURFORD**

	a		b		c	d		
	V1	l	V1	V2				
<b>30-223-00</b>	45,0 mm	l	65,0 mm	62,0 mm	l	62,0 mm	200,0 mm	200,0 mm
<b>30-224-00</b>	45,0 mm	l	65,0 mm	62,0 mm	l	62,0 mm	250,0 mm	200,0 mm
<b>30-225-00</b>	45,0 mm	l	65,0 mm	62,0 mm	l	62,0 mm	300,0 mm	200,0 mm





### BURFORD

- 30-227-01** V1 40 x 65 mm
- 30-227-02** V2 72 x 65 mm

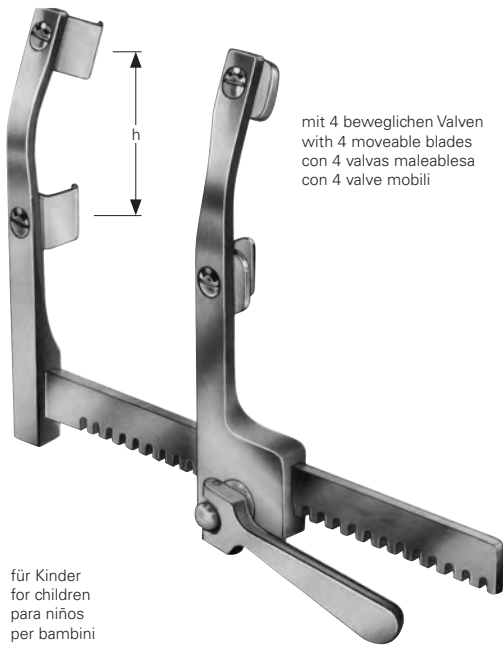
Valvenpaar  
 Pairs of valves  
 Pares de valvas  
 paia di valve

für Erwachsene  
 for adults  
 para adultos  
 per adulti

### BURFORD

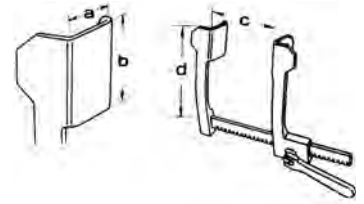
	a		b		c	d
	V1	V2	V1	V2		
<b>30-226-00</b>	40,0 mm	72,0 mm	65,0 mm	65,0 mm	200,0 mm	195,0 mm
<b>30-226-10</b>	40,0 mm	72,0 mm	65,0 mm	65,0 mm	250,0 mm	195,0 mm
<b>30-227-00</b>	40,0 mm	72,0 mm	65,0 mm	65,0 mm	300,0 mm	195,0 mm





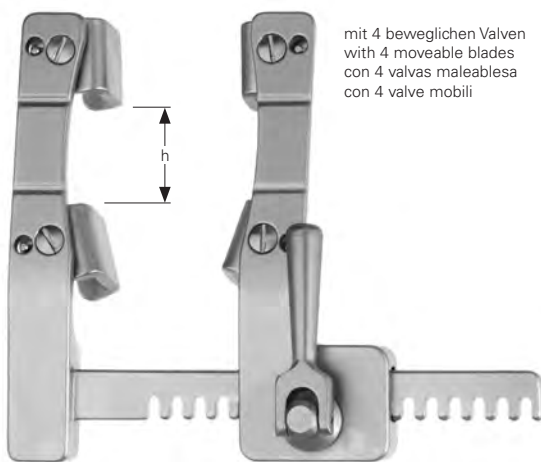
mit 4 beweglichen Valven  
with 4 moveable blades  
con 4 valvas maleables  
con 4 valve mobili

für Kinder  
for children  
para niños  
per bambini



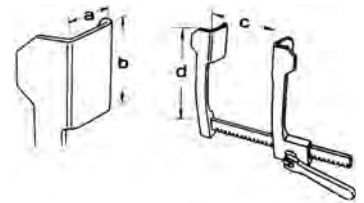
**MORSE-FAVALORO**

	h	a	b	c	d
<b>30-228-00</b>	50,0 mm	12,0 mm	20,0 mm	155,0 mm	120,0 mm



mit 4 beweglichen Valven  
with 4 moveable blades  
con 4 valvas maleables  
con 4 valve mobili

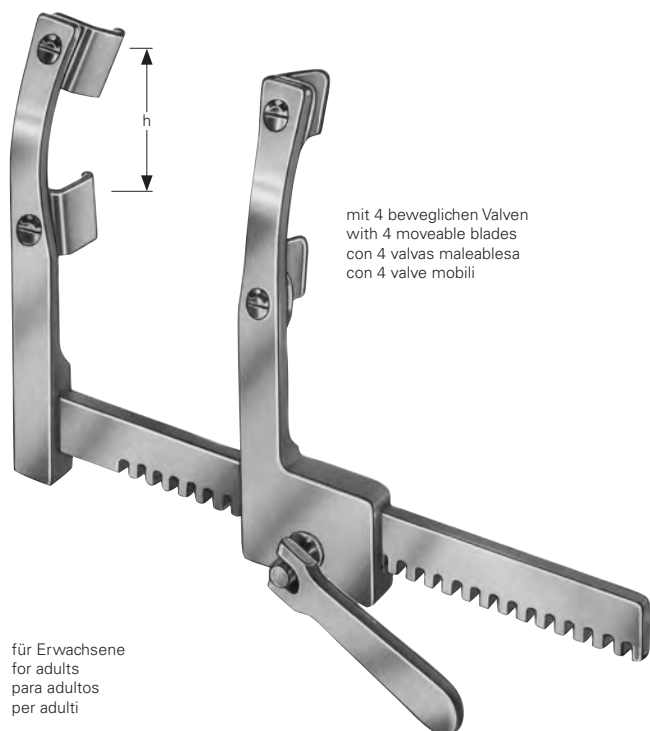
für Kinder  
for children  
para niños  
per bambini



**MORSE**

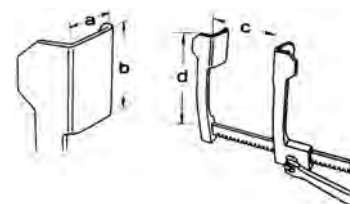
	h	a	b	c	d
<b>30-228-10</b>	18,0 mm	15,0 mm	12,0 mm	46,0 mm	56,0 mm
<b>30-228-11</b>	18,0 mm	15,0 mm	12,0 mm	65,0 mm	56,0 mm
<b>30-228-12</b>	41,0 mm	23,0 mm	20,0 mm	100,0 mm	148,0 mm
<b>30-228-13</b>	41,0 mm	23,0 mm	20,0 mm	130,0 mm	148,0 mm
<b>30-228-14</b>	41,0 mm	23,0 mm	20,0 mm	160,0 mm	148,0 mm





mit 4 beweglichen Valven  
 with 4 moveable blades  
 con 4 valvas maleables  
 con 4 valve mobili

für Erwachsene  
 for adults  
 para adultos  
 per adulti



### MORSE



	h	a	b	c	d
<b>30-229-00</b>	72,0 mm	20,0 mm	28,0 mm	200,0 mm	150,0 mm



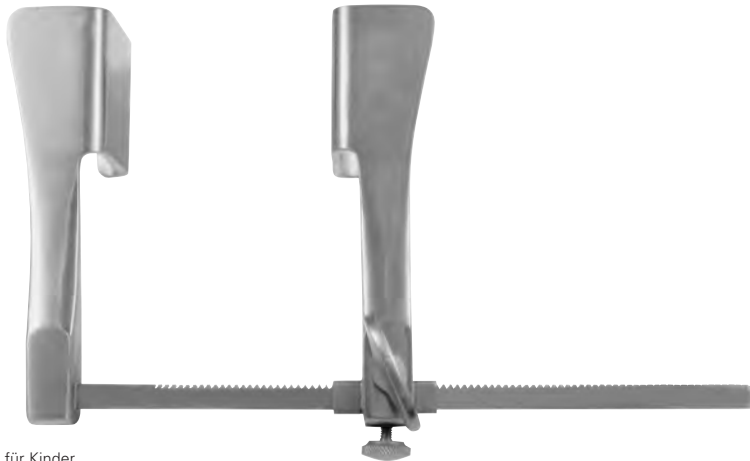
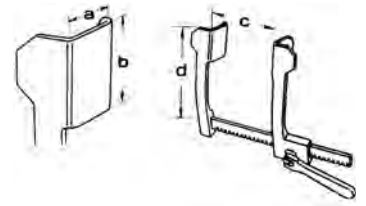
mit 2 beweglichen Valven  
 with 2 moveable blades  
 con 2 valvas maleables  
 con 2 valve mobili

für Säuglinge  
 for infants  
 para bebés  
 per neonati

### TURN-OVER



	a	b	c	d
<b>30-230-00</b>	10,0 mm	30,0 mm	65,0 mm	65,0 mm
<b>30-230-01</b>	14,0 mm	45,0 mm	80,0 mm	75,0 mm
<b>30-230-02</b>	18,0 mm	58,0 mm	90,0 mm	85,0 mm

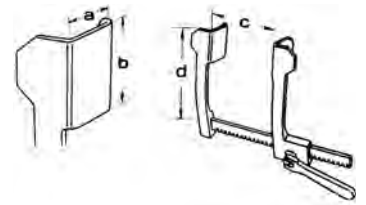


für Kinder  
 for children  
 para niños  
 per bambini

**TUFFIER**

	a	b	c	d
<b>30-231-00</b>	42,0 mm	45,0 mm	170,0 mm	110,0 mm

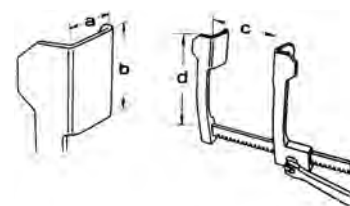
**STEEL**  
 STAINLESS



**HERTZLER**

	a	b	c	d
<b>30-232-00</b>	20,0 mm	25,0 mm	105,0 mm	120,0 mm

**STEEL**  
 STAINLESS



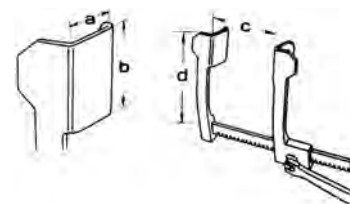
für Kinder  
 for children  
 para niños  
 per bambini

### HAIGHT

a b c d



<b>30-233-00</b>	30,0 mm	30,0 mm	120,0 mm	90,0 mm
<b>30-233-01</b>	30,0 mm	30,0 mm	120,0 mm	64,0 mm



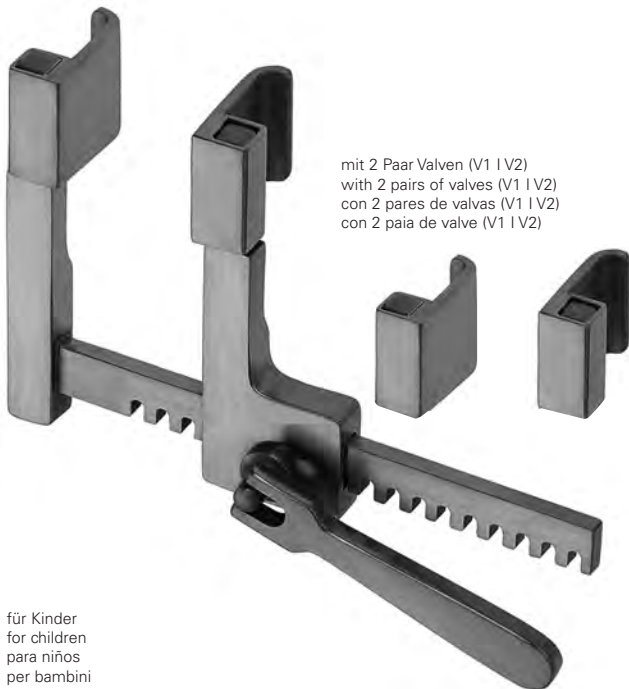
für Erwachsene  
 for adults  
 para adultos  
 per adulti

### CHEVALIER

a b c d



<b>30-234-00</b>	30,0 mm	100,0 mm	210,0 mm	185,0 mm
------------------	---------	----------	----------	----------



mit 2 Paar Valven (V1 | V2)  
with 2 pairs of valves (V1 | V2)  
con 2 pares de valvas (V1 | V2)  
con 2 paia de valve (V1 | V2)

für Kinder  
for children  
para niños  
per bambini

**STRUCK**

**30-235-06**

Sperrer allein  
Spreader only  
Separador solo  
Divaricatore suelto



**STRUCK**

**30-235-01** 10 x 10 mm

**30-235-02** 10 x 15 mm

**30-235-03** 10 x 20 mm

**30-235-04** V1 15 x 20 mm

**30-235-05** V2 20 x 20 mm

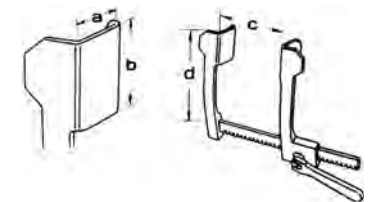
Valvenpaar  
Pair of valves  
Pares de valvas  
paia di valve

**STRUCK**

	V1	a l	V2	V1	b l	V2	c	d
<b>30-235-00</b>	15,0 mm	l	20,0 mm	20,0 mm	l	20,0 mm	70,0 mm	64,0 mm



für Kinder  
for children  
para niños  
per bambini

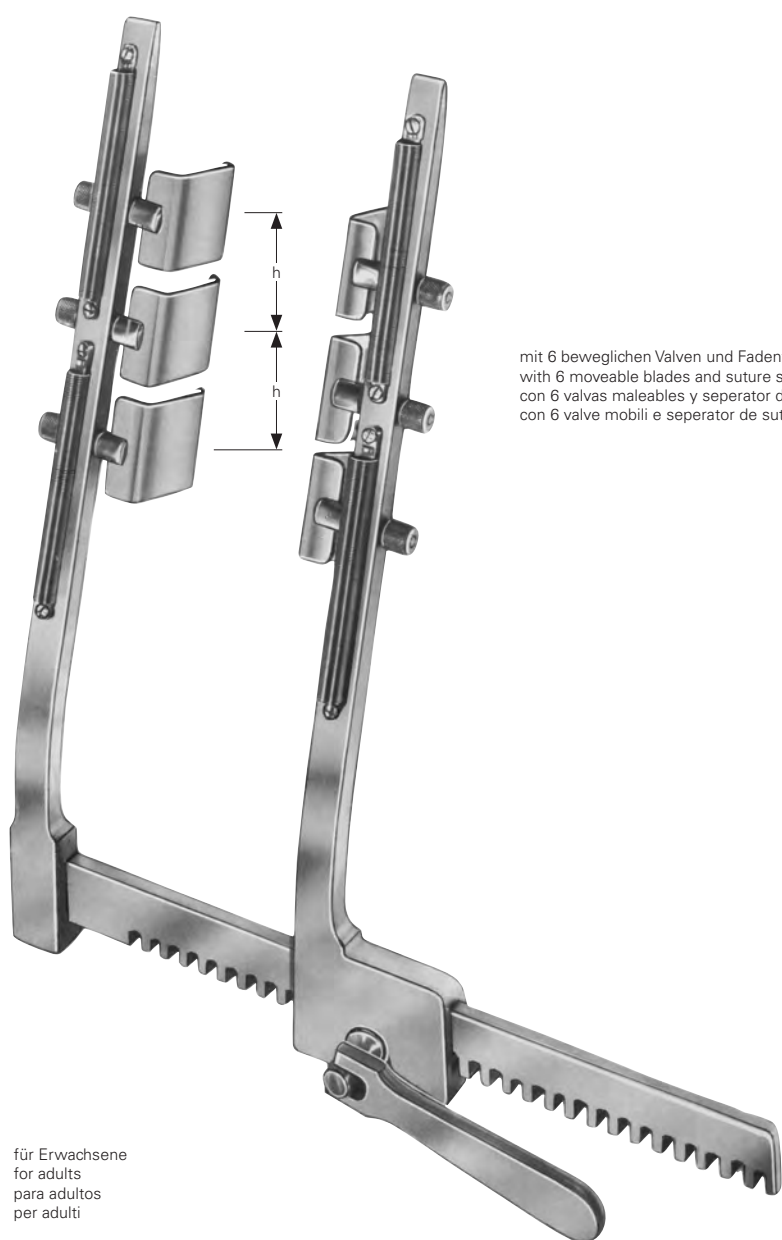
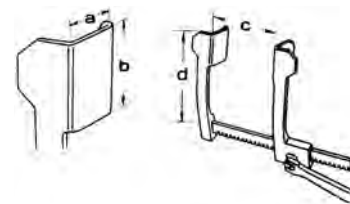


**RIENHOFF**

	a	b	c	d
<b>30-235-50</b>	30,0 mm	33,0 mm	140,0 mm	116,0 mm
<b>30-235-51</b>	47,0 mm	45,0 mm	140,0 mm	146,0 mm







mit 6 beweglichen Valven und Fadenfänger  
 with 6 moveable blades and suture seperator  
 con 6 valvas maleables y seperator de la sutura  
 con 6 valve mobili e seperator de suture

für Erwachsene  
 for adults  
 para adultos  
 per adulti

**ANKENEY**

h

a

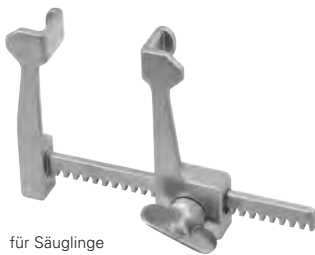
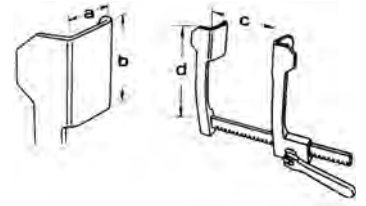
b

c

d



<b>30-236-00</b>	45,0 mm	33,0 mm	35,0 mm	180,0 mm	300,0 mm
------------------	---------	---------	---------	----------	----------

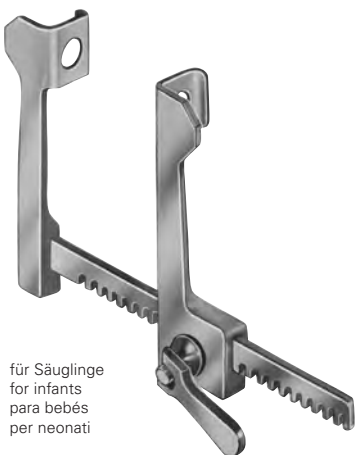
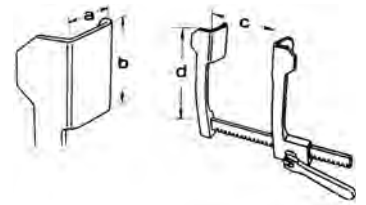


für Säuglinge  
 for infants  
 para bebés  
 per neonati

**FINOCHIETTO**

	a	b	c	d
<b>30-236-50</b>	6,0 mm	7,0 mm	36,0 mm	25,0 mm

**STEEL**  
 STAINLESS



für Säuglinge  
 for infants  
 para bebés  
 per neonati

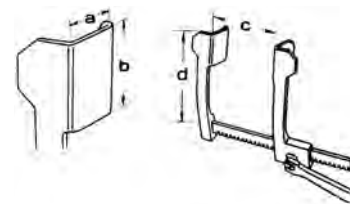
**FINOCHIETTO**

	a	b	c	d
<b>30-237-00</b>	14,0 mm	15,0 mm	55,0 mm	55,0 mm
<b>30-238-00</b>	19,0 mm	20,0 mm	75,0 mm	55,0 mm

**STEEL**  
 STAINLESS



für Kinder  
 for children  
 para niños  
 per bambini



### FINOCHIETTO

a

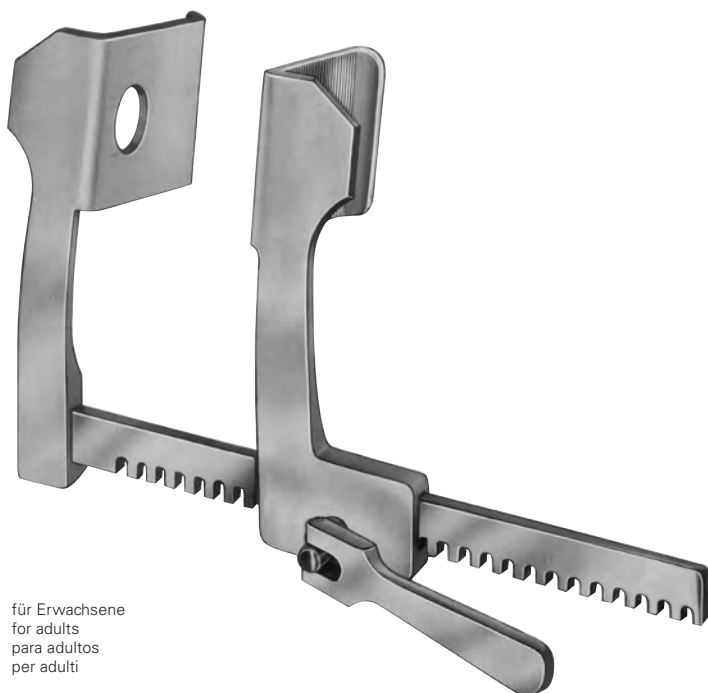
b

c

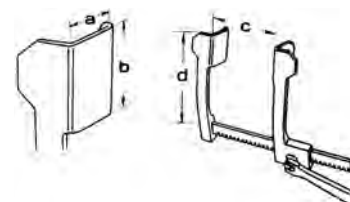
d



<b>30-239-00</b>	28,0 mm	30,0 mm	100,0 mm	75,0 mm
<b>30-240-00</b>	30,0 mm	45,0 mm	140,0 mm	110,0 mm



für Erwachsene  
 for adults  
 para adultos  
 per adulti



### FINOCHIETTO

a

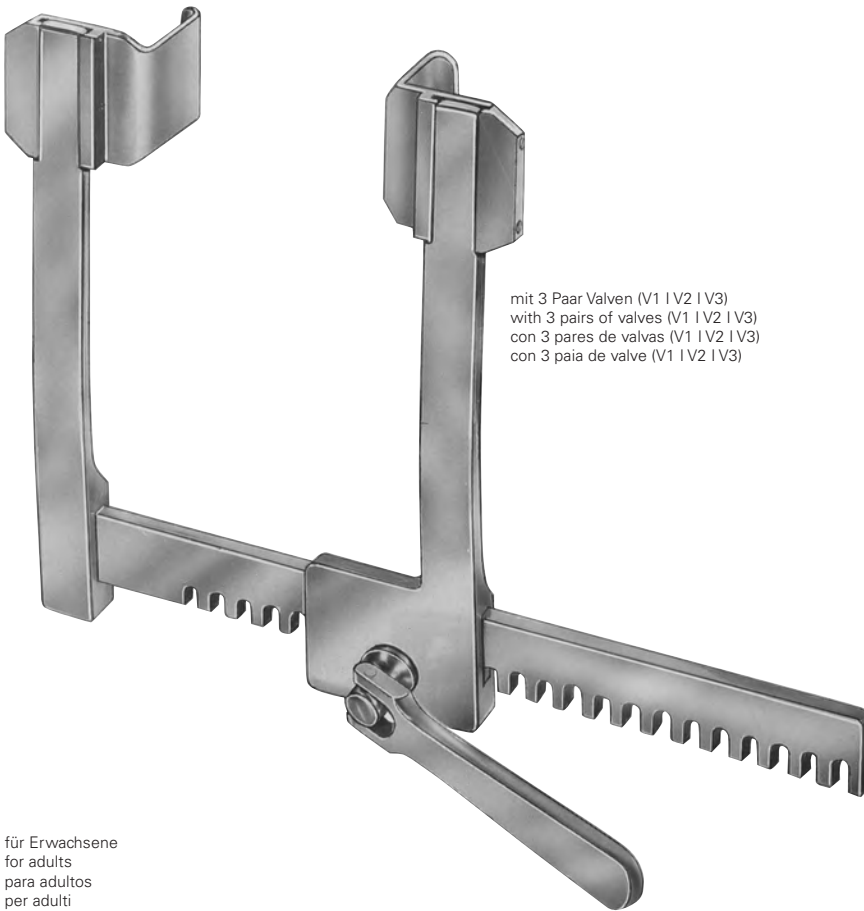
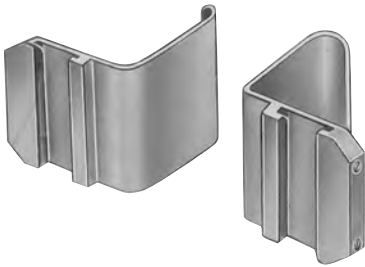
b

c

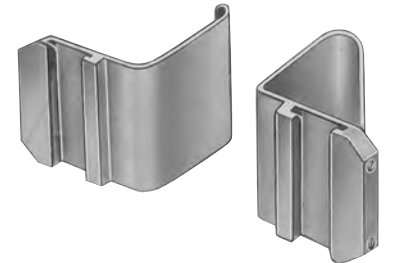
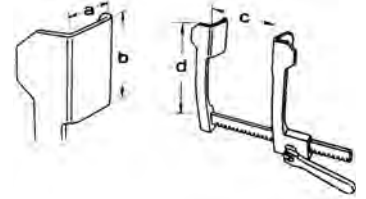
d



<b>30-241-00</b>	42,0 mm	62,0 mm	185,0 mm	140,0 mm
<b>30-242-00</b>	73,0 mm	65,0 mm	185,0 mm	140,0 mm



mit 3 Paar Valven (V1 | V2 | V3)  
with 3 pairs of valves (V1 | V2 | V3)  
con 3 pares de valvas (V1 | V2 | V3)  
con 3 paia de valve (V1 | V2 | V3)



für Erwachsene  
for adults  
para adultos  
per adulti

**DE BAKEY**

	a			b			c	d
	V1	V2	V3	V1	V2	V3		
<b>30-245-00</b>	30 mm	40 mm	50 mm	30 mm	40 mm	50 mm	150,0 mm	180,0 mm

**DE BAKEY**

- 30-245-03** V1 30 x 30 mm
- 30-245-04** V2 40 x 40 mm
- 30-245-05** V3 50 x 50 mm

Valvenpaar  
Pairs of valves  
Pares de valvas  
paia di valve

**DE BAKEY**

**30-245-01**

Sperrer allein  
Spreader only  
Separador solo  
Divaricatore suelto

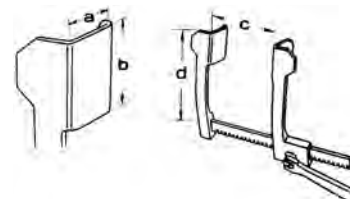




für Erwachsene  
 for adults  
 para adultos  
 per adulti

### DE BAKEY

	a			b			c	d
	V1	V2	V3	V1	V2	V3		
<b>30-246-00</b>	60 mm	50 mm	40 mm	60 mm	80 mm	100mm	200,0 mm	185,0 mm



### DE BAKEY

**30-246-02** 50 x 66 mm

Valvenpaar  
 Pairs of valves  
 Pares de valvas  
 paia di valve



### DE BAKEY

**30-246-03** V1 60 x 60 mm

**30-246-04** V2 50 x 80 mm

**30-246-05** V3 40 x 100 mm

**30-246-06** 80 x 60 mm

Valvenpaar  
 Pairs of valves  
 Pares de valvas  
 paia di valve

### DE BAKEY

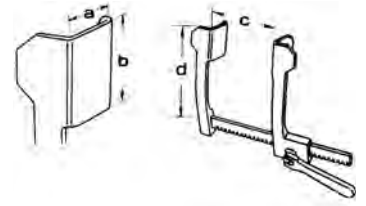
**30-246-01**

Sperrer allein  
 Spreader only  
 Separador solo  
 Divaricatore suelto






für Kinder  
 for children  
 para niños  
 per bambini



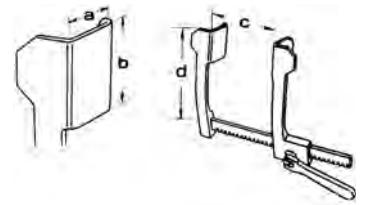
**COOLEY**

a b c d 

<b>30-247-00</b>	20,0 mm	45,0 mm	140,0 mm	110,0 mm
------------------	---------	---------	----------	----------



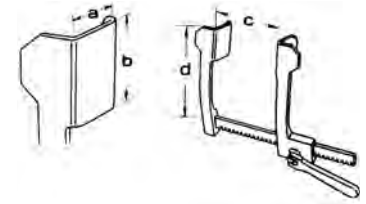
für Erwachsene  
 for adults  
 para adultos  
 per adulti



**COOLEY**

a b c d 

<b>30-248-00</b>	30,0 mm	50,0 mm	185,0 mm	145,0 mm
------------------	---------	---------	----------	----------



für Erwachsene  
 for adults  
 para adultos  
 per adulti

**COOLEY**

a

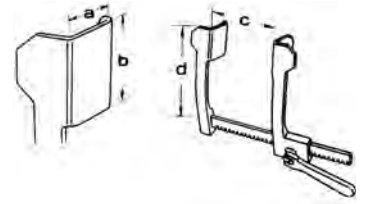
b

c

d



<b>30-249-00</b>	35,0 mm	100,0 mm	180,0 mm	165,0 mm
<b>30-250-00</b>	35,0 mm	110,0 mm	230,0 mm	205,0 mm



mit 2 Paar Valven (V1 | V2)  
with 2 pairs of valves (V1 | V2)  
con 2 pares de valvas (V1 | V2)  
con 2 paia de valve (V1 | V2)



**MERCEDES**

**30-251-02** V1 42 x 65 mm  
**30-251-03** V1 75 x 75 mm

Valvenpaar  
Pair of valves  
Pares de valvas  
paia di valve

**MERCEDES**

**30-251-01**

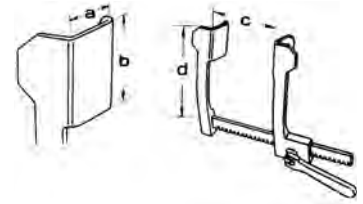
Sperrer allein  
Spreader only  
Separador solo  
Divaricatore suelto



**MERCEDES**

	a		b		c	d
	V1	V2	V1	V2		
<b>30-251-00</b>	42,0 mm	75,0 mm	65,0 mm	75,0 mm	240,0 mm	185,0 mm





a

b

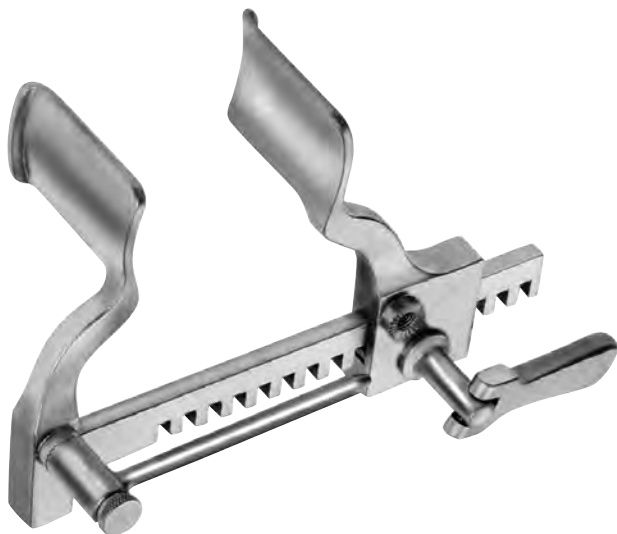
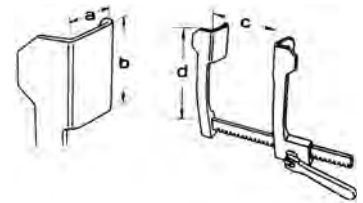
c

d

30-252-00

30,0 mm

60,0 mm



a

b

c

d

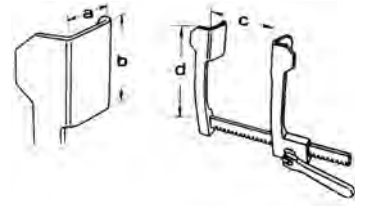
30-252-01

30,0 mm

60,0 mm



mit 2 Paar Valven (V1 | V2)  
with 2 pairs of valves (V1 | V2)  
con 2 pares de valvas (V1 | V2)  
con 2 paia de valve (V1 | V2)



	V1	a	V2	V1	b	V2	c	d
<b>30-252-02</b>	30,0 mm		30,0 mm	40,0 mm		60,0 mm		



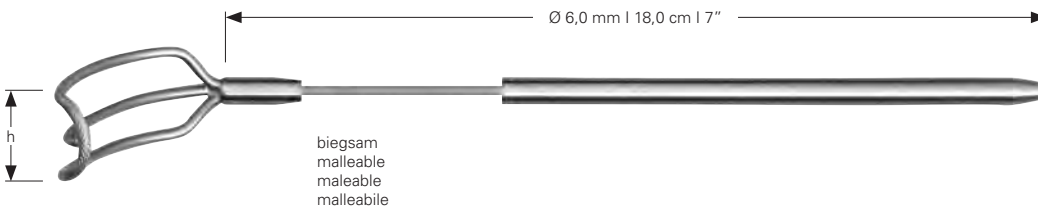
**30-252-20** Ø 6,0 mm

Fixierklammer  
Fixation clamp  
Pinza de fijación  
Clip di fissaggio



**30-252-21** Ø 6,0 mm

Fixierklammer  
Fixation clamp  
Pinza de fijación  
Clip di fissaggio



biegsam  
malleable  
maleable  
malleabile

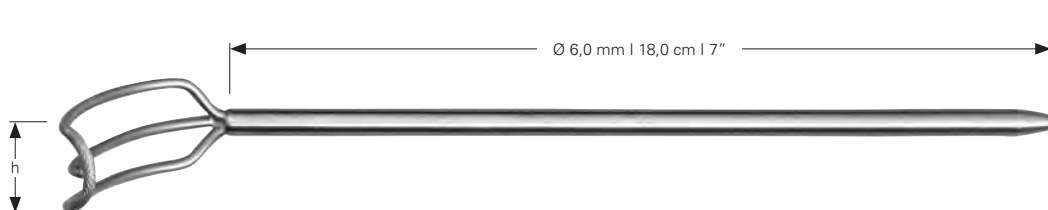


**30-253-01** h = 20,0 mm

**30-253-02** h = 35,0 mm

**30-253-03** h = 45,0 mm

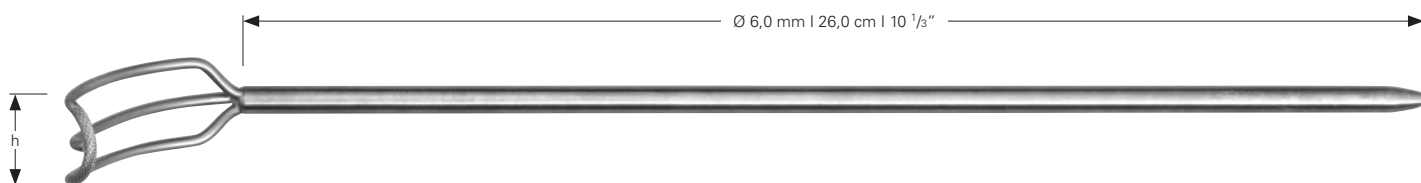
Atrial Haken  
Atrial Retractor  
Gancho auricular  
Gancio atriale



 **HEART-GATE**

<b>30-253-11</b>	h = 20,0 mm
<b>30-253-12</b>	h = 35,0 mm
<b>30-253-13</b>	h = 45,0 mm <small>TRICUSPID</small>
<b>30-253-14</b>	h = 45,0 mm

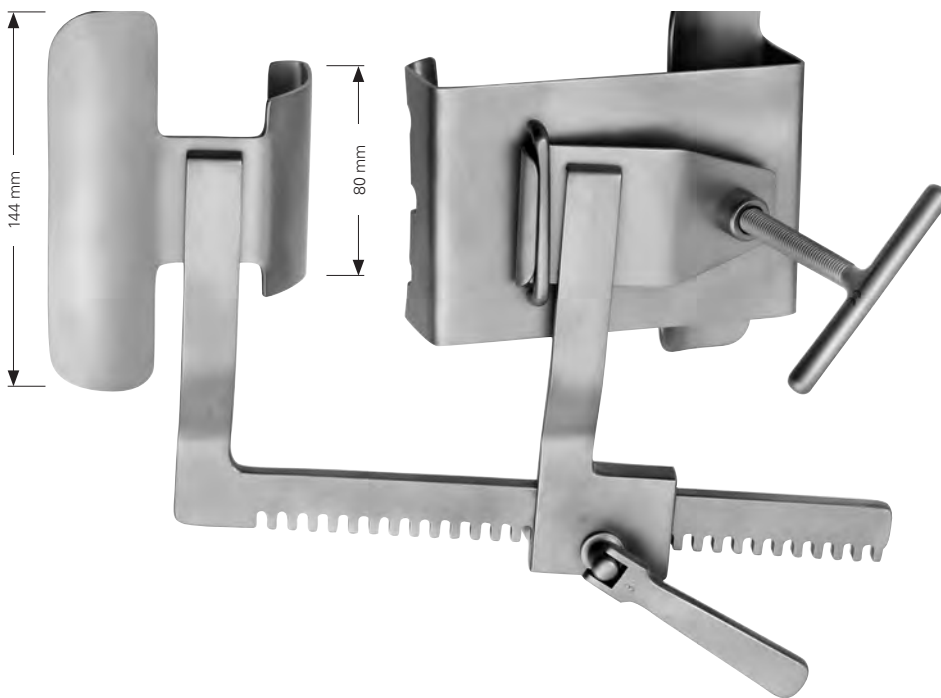
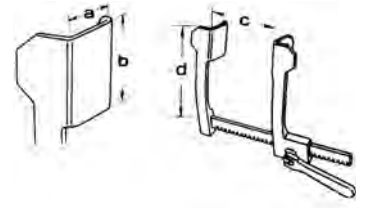
Atrial Haken  
Atrial Retractor  
Gancho auricular  
Gancio atriale



 **HEART-GATE**

<b>30-253-21</b>	h = 20,0 mm
<b>30-253-22</b>	h = 35,0 mm
<b>30-253-23</b>	h = 45,0 mm <small>TRICUSPID</small>
<b>30-253-24</b>	h = 45,0 mm

Atrial Haken  
Atrial Retractor  
Gancho auricular  
Gancio atriale



**I.M.A.**

a

b

c

d

**30-254-00**

40,0 mm

100,0 mm

134,0 mm

195,0 mm

**I.M.A.**

**30-254-02** 40 x 100 mm

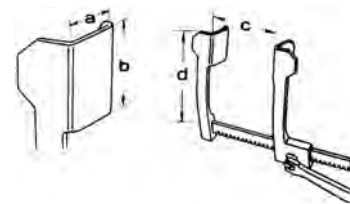
Mammaria Valve, allein  
Mammaria valve, only  
Valva mamaria, suelto  
Valva mammaria, solo

**I.M.A.**

**30-254-01**

Sperrer, allein  
Spreader, only  
Separador, suelto  
Divaricatore, solo





**I.M.A.**

**30-254-12** V1 30 x 50 mm

Mammaria Valve, komplett links und rechts  
Mammaria valve, complete left and right  
Valva mamaria, completo izquierda y derecha  
Valva Mammaria, completo sinistra e destra



**I.M.A.**

	a			b			c	d
	V1	V2	V3	V1	V2	V3		
<b>30-254-10</b>	30 mm	30 mm	40 mm	50 mm	100 mm	100mm	215,0 mm	140,0 mm



**I.M.A.**

**30-254-13** V2 30 x 100 mm

**30-254-14** V3 40 x 100 mm

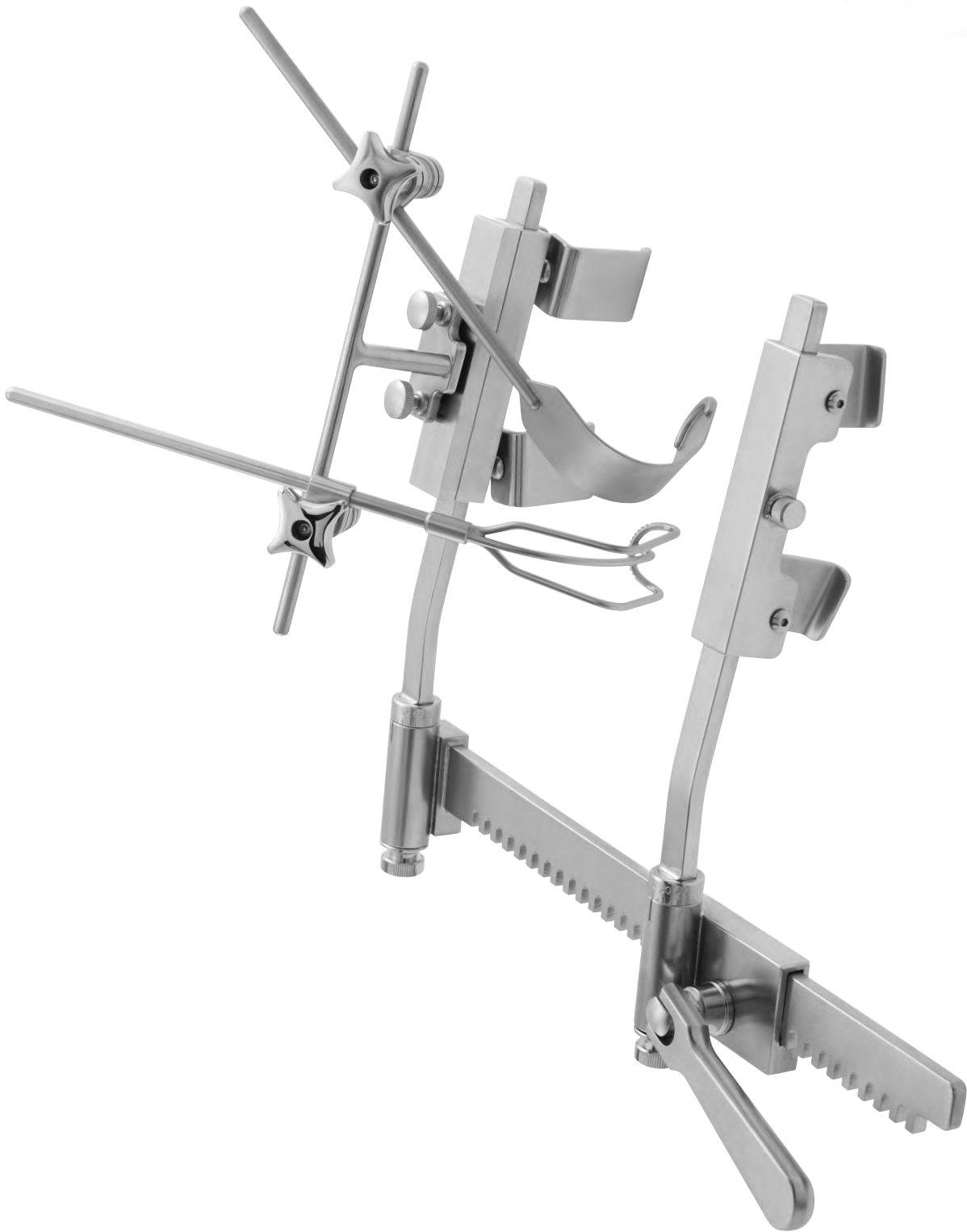
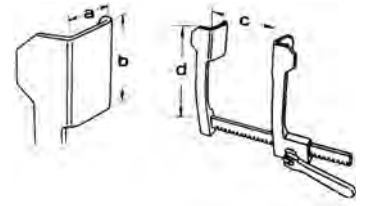
Sternumvalven, paar  
Sternum valves, pair  
Sternum valca, pareja  
Sternum valve, coppia

**I.M.A.**

**30-254-11**

Sperrer, allein  
Spreader, only  
Separador, suelto  
Divaricatore, solo





I.M.A.

a

b

c

d

STEEL  
STAINLESS

30-254-20

30,0 mm

27,0 mm

230,0 mm

205,0 mm



## COOLEY

**30-254-30** 25 x 35 mm

**30-254-31** 40 x 35 mm

**30-254-32** 50 x 35 mm

Wundhaken  
Retractors  
Separadores  
Divaricatori



## RIBBON

**30-254-33** 30 x 27 mm

Wundhaken, biegsam  
Retractors, malleable  
Separadores, maleable  
Divaricatori, malleabile

## I.M.A.

**30-254-20** SET

I.M.A. Sperrer komplett,  
bestehend aus:

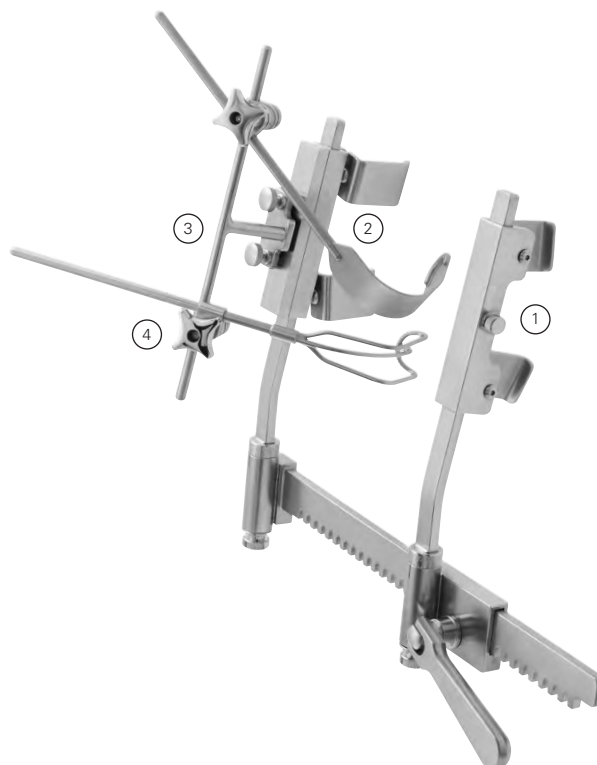
1 Sperrer	<b>30-254-21</b>	1 Spreader	<b>30-254-21</b>
1 Doppelaufsteckvalve	<b>30-254-22</b>	1 Double fixation valve	<b>30-254-22</b>
1 Doppelaufsteckvalve	<b>30-254-23</b>	1 Double fixation valve	<b>30-254-23</b>
1 T - Gestell	<b>30-254-24</b>	1 T - rack	<b>30-254-24</b>
2 Universalklemme	<b>30-254-25</b>	2 Universal clamp	<b>30-254-25</b>
2 Retraktor, 25 mm	<b>30-254-30</b>	2 Retractor, 25 mm	<b>30-254-30</b>
1 Retraktor, 40 mm	<b>30-254-31</b>	1 Retractor, 40 mm	<b>30-254-31</b>
1 Retraktor, 50 mm	<b>30-254-32</b>	1 Retractor, 50 mm	<b>30-254-32</b>
2 Retraktor, 25 mm	<b>30-254-33</b>	2 Retractor, 25 mm	<b>30-254-33</b>

Separador I.M.A., completo,  
compuesto de:

1 Separador	<b>30-254-21</b>	1 Divaricatori	<b>30-254-21</b>
1 Valva de doble inserción	<b>30-254-22</b>	1 Valvola di fissaggio	<b>30-254-22</b>
1 Valva de doble inserción	<b>30-254-23</b>	1 Valvola di fissaggio	<b>30-254-23</b>
1 Bastidor en T	<b>30-254-24</b>	1 Telaio a T	<b>30-254-24</b>
2 Pinza universal	<b>30-254-25</b>	2 Morsetto universale	<b>30-254-25</b>
2 Separador, 25 mm	<b>30-254-30</b>	2 Divaricatori, 25 mm	<b>30-254-30</b>
1 Separador, 40 mm	<b>30-254-31</b>	1 Divaricatori, 40 mm	<b>30-254-31</b>
1 Separador, 50 mm	<b>30-254-32</b>	1 Divaricatori, 50 mm	<b>30-254-32</b>
2 Separador, 25 mm	<b>30-254-33</b>	2 Divaricatori, 25 mm	<b>30-254-33</b>

I.M.A. spreader complete,  
consisting of:

Divaricatori I.M.A., completo,  
composto da:



## I.M.A.

**30-254-25**

Universalklemme mit Zahnung  
Universal clamp with teeth  
Pinza universal con dentado  
Morsetto universale con dentellatura

## I.M.A.

**30-254-24**

T - Gestell  
T - rack  
Bastidor en T  
Telaio a T

## I.M.A.

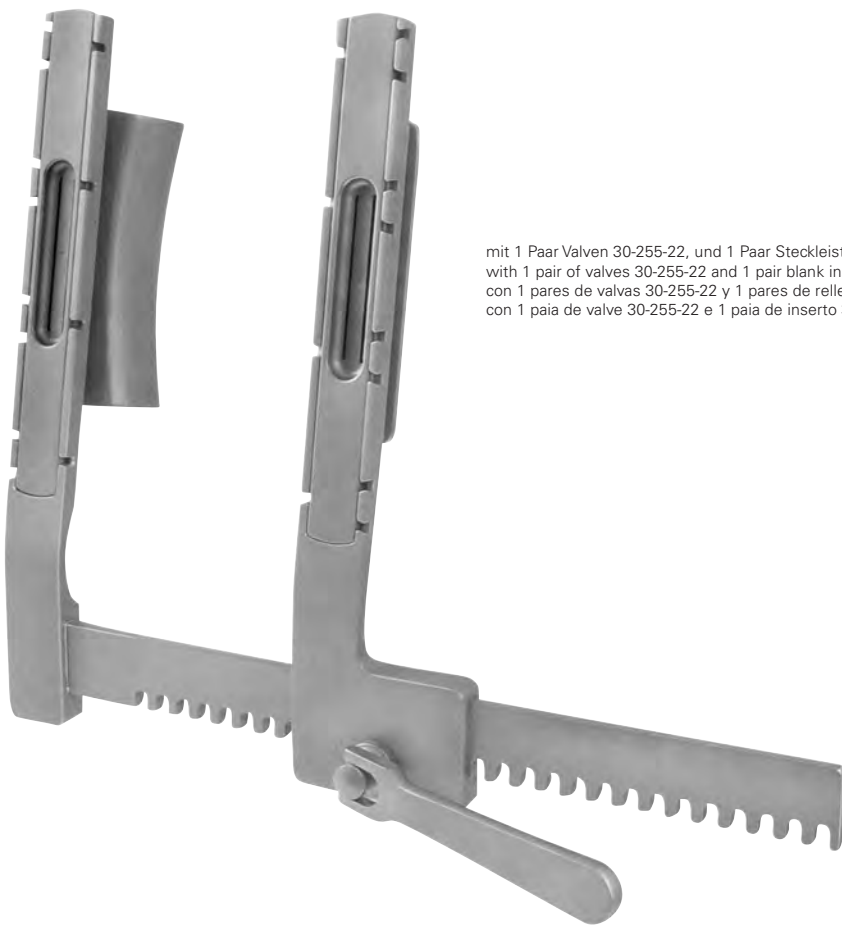
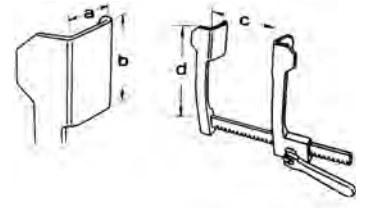
**30-254-23** 30 x 27 mm

Doppelaufsteckvalve für T - Gestell  
Double fixation valve for T - rack  
Valva de doble inserción para bastidor en T  
Valvola di fissaggio doppia per telaio a T

## I.M.A.

**30-254-22** 30 x 27 mm

Doppelaufsteckvalve  
Double fixation valve  
Valva de doble inserción  
Valvola di fissaggio doppia



mit 1 Paar Valven 30-255-22, und 1 Paar Steckleisten 30-255-10  
 with 1 pair of valves 30-255-22 and 1 pair blank inserts 30-255-10  
 con 1 pares de valvas 30-255-22 y 1 pares de rellenos 30-255-10  
 con 1 paio de valve 30-255-22 e 1 paio de inserto 30-255-10

**CARDIOBASE**

	a	b	c	d
<b>30-255-00</b>	30,0 mm	100,0 mm	190,0 mm	190,0 mm



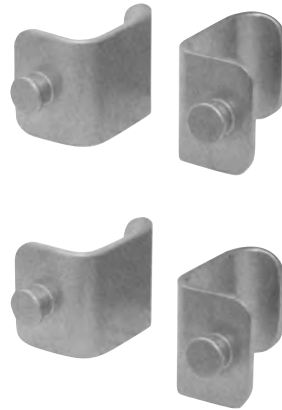




## CARDIOBASE

**30-255-10**

Steckleistenpaar  
 Pair blank inserts  
 Pares de rellenos  
 Paia de inserto

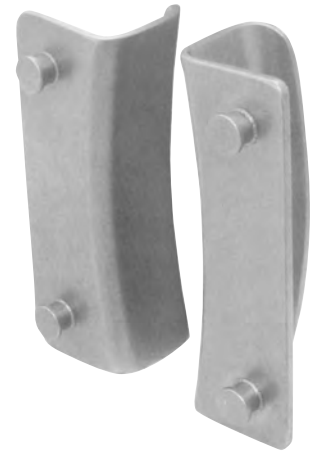


## MORSE

**30-255-20** 30 x 28 mm

**30-255-21** 40 x 28 mm

2 Paar Valven  
 2 pairs of valves  
 2 pares de valvas  
 2 paia de valve



## COOLEY

**30-255-22** 30 x 100 mm

**30-255-23** 40 x 100 mm

Valvenpaar  
 Pair of valves  
 Pares de valvas  
 paia di valve



Verpackungseinheit: 3 St.  
 Packing unit: 3 pieces  
 Unidad: 3 piezas  
 Confezione: 3 pezzi



## CARDIOBASE

**30-255-30**

Retraktorhalterung  
 Retractor holder  
 Soporte de seperador  
 Supporto di divaricatori



## CARDIOBASE

**30-255-31** 55 x 18 mm

**30-255-32** 80 x 18 mm

**30-255-33** 80 x 22 mm

Retraktor  
 Retractor  
 Seperador  
 Divaricatori



**BAILEY-GIBBON**

**30-262-14** 16,0 cm, 6 ¼"



für Kinder  
 for children  
 para niños  
 per bambini

**BAILEY-GIBBON**

**30-263-16** 18,0 cm, 7"



für Erwachsene  
 for adults  
 para adultos  
 per adulti

**BAILEY-GIBBON**

**30-264-16** 18,0 cm, 7"



**SELLORS**

**30-265-19** 19,0 cm, 7 ½"



**ALLISON**

**30-301-26** 26,0 cm, 10 ¼"

**30-301-32** 32,0 cm, 12 ½"



**30-301-26** 40,0 mm

**30-301-32** 65,0 mm

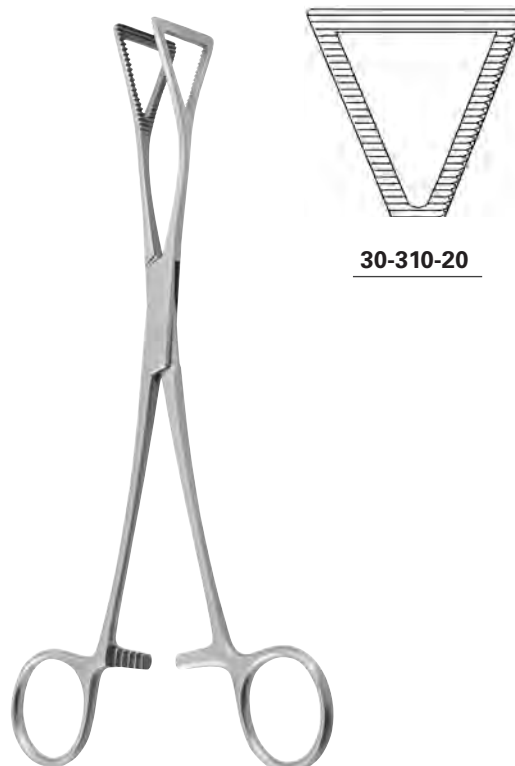
Lungenspatel, Lungenfaßzangen  
 Lung spatulas, Lung grasping forceps  
 Espátulas pulmonares, Pinzas para coger el pulmón  
 Spatole per pulmone, Pinze per afferrare polmone



**30-302-26** 132,0 mm

**ALLISON**

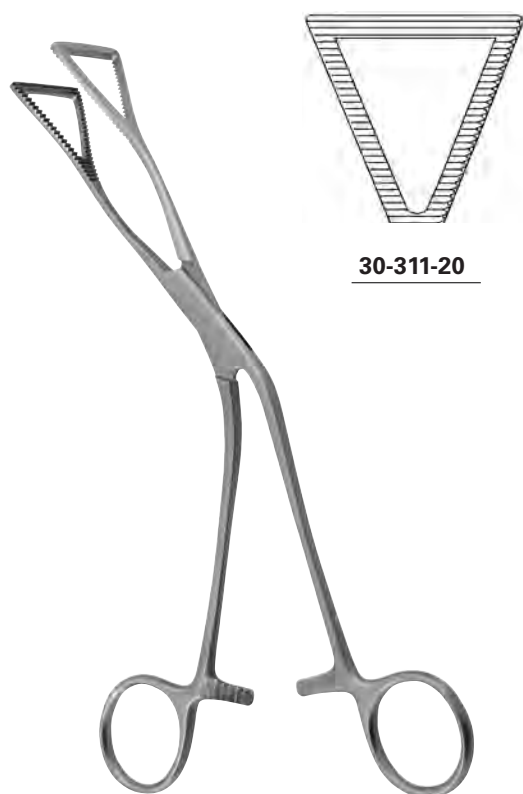
**30-302-26** 26,0 cm, 10 1/4"



**30-310-20**

**LOVELACE**

**30-310-20** 20,0 cm, 8"



**30-311-20**

**LOVELACE**

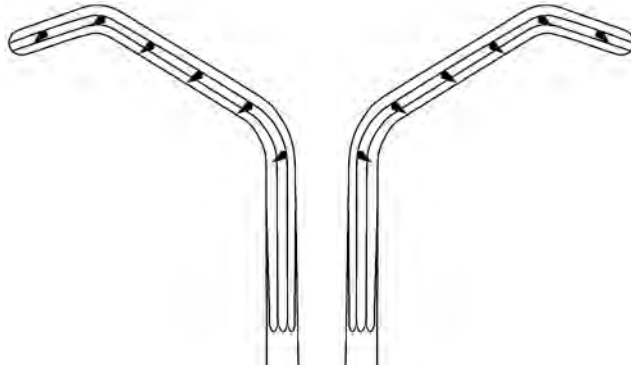
**30-311-20** 20,0 cm, 8"



**30-313-22**

**PRINCE-THOMAS**

**30-313-22** 22,0 cm, 8 3/4"



**30-315-22**

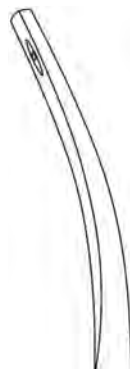
links  
left  
izquierda  
sinistra

**30-317-22**

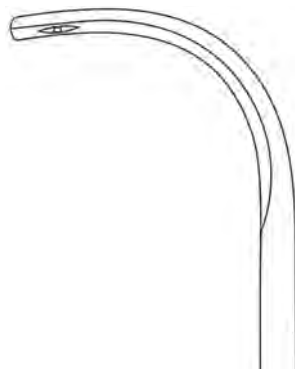
rechts  
right  
derecha  
destra

**PRINCE-THOMAS**

**30-315-22 - 30-317-22** 22,0 cm, 8 <sup>3</sup>/<sub>4</sub> "



**30-325-23**



**30-327-23**

**SEMB**

**30-325-23 - 30-327-23** 24,0 cm, 9 <sup>1</sup>/<sub>2</sub> "

# 31

Herz- und Gefässchirurgie

Cardiovascular Surgery

Cirurgía cardiovascular

Chirurgia cardiovascolare





# 31

Mikro Instrumente  
Micro Instruments  
Instrumentos de micro  
Strumentario micro





**NABATOFF**

**31-010-00** SET

Komplett, bestehend aus:

Complete, consisting of:

1 Zugseil	<b>31-010-01</b>	1 Traction cable	<b>31-010-01</b>
1 Kunststoffspitze	<b>31-010-02</b>	1 Plastic probe tip	<b>31-010-02</b>
1 Sondenspitze, Ø 3 mm	<b>31-010-03</b>	1 Probe Tip, Ø 3 mm	<b>31-010-03</b>
1 Olive, Ø 6 mm	<b>31-010-04</b>	1 Olive, Ø 6 mm	<b>31-010-04</b>
1 Olive, Ø 9 mm	<b>31-010-05</b>	1 Olive, Ø 9 mm	<b>31-010-05</b>
1 Olive, Ø 12 mm	<b>31-010-06</b>	1 Olive, Ø 12 mm	<b>31-010-06</b>
1 Olive, Ø 15 mm	<b>31-010-07</b>	1 Olive, Ø 15 mm	<b>31-010-07</b>
1 T -Griff	<b>31-010-08</b>	1 T -Handle	<b>31-010-08</b>
1 Metalletui	<b>31-010-09</b>	1 Metal case	<b>31-010-09</b>

Completo, compuesto de:

Completo, composto da:

1 Cable de tracción	<b>31-010-01</b>	1 Fune di trazione	<b>31-010-01</b>
1 Punta plástica	<b>31-010-02</b>	1 Punta di plastica	<b>31-010-02</b>
1 Punta metálica, Ø 3 mm	<b>31-010-03</b>	1 Punta metallica, Ø 3 mm	<b>31-010-03</b>
1 Oliva, Ø 6 mm	<b>31-010-04</b>	1 Oliva, Ø 6 mm	<b>31-010-04</b>
1 Oliva, Ø 9 mm	<b>31-010-05</b>	1 Oliva, Ø 9 mm	<b>31-010-05</b>
1 Oliva, Ø 12 mm	<b>31-010-06</b>	1 Oliva, Ø 12 mm	<b>31-010-06</b>
1 Oliva, Ø 15 mm	<b>31-010-07</b>	1 Oliva, Ø 15 mm	<b>31-010-07</b>
1 Mango, forma T	<b>31-010-08</b>	1 Mango, forma T	<b>31-010-08</b>
1 Caja metálica	<b>31-010-09</b>	1 Scatola metallica	<b>31-010-09</b>



**NABATOFF**

<b>31-010-04</b>	Ø 6,0 mm
<b>31-010-05</b>	Ø 9,0 mm
<b>31-010-06</b>	Ø 12,0 mm
<b>31-010-07</b>	Ø 15,0 mm

Olive  
 Olive  
 Oliva  
 Oliva



**NABATOFF**

**31-010-01** 90,0 cm, 35 1/2"

Zugseil  
 Traction cable  
 Cable de tracción  
 Fune di trazione



**NABATOFF**

**31-010-02**

Kunststoffspitze  
 Plastic probe tip  
 Punta plástica  
 Punta di plastica



**NABATOFF**

**31-010-03** Ø 3,0 mm

Sondenspitze Metall  
 Plastic probe tip  
 Punta metálica  
 Punta metallica



**NABATOFF**

**31-010-08**

T -Griff  
 T -Handle  
 Mango, forma T  
 Mango, forma T







## VARADY

**31-011-00** SET

Komplett, bestehend aus:

1 Zugseil	<b>31-011-01</b>
1 Olive, Ø 3 mm	<b>31-011-03</b>
1 Olive, Ø 4 mm	<b>31-011-04</b>
1 Olive, Ø 5 mm	<b>31-011-05</b>
1 Metalletui	<b>31-011-09</b>

Complete, consisting of:

1 Traction cable	<b>31-011-01</b>
1 Olive, Ø 3 mm	<b>31-011-03</b>
1 Olive, Ø 4 mm	<b>31-011-04</b>
1 Olive, Ø 5 mm	<b>31-011-05</b>
1 Metal case	<b>31-011-09</b>

Completo, compuesto de:

1 Cable de tracción	<b>31-011-01</b>
1 Oliva, Ø 3 mm	<b>31-011-03</b>
1 Oliva, Ø 4 mm	<b>31-011-04</b>
1 Oliva, Ø 5 mm	<b>31-011-05</b>
1 Caja metálica	<b>31-011-09</b>

Completo, composto da:

1 Fune di trazione	<b>31-011-01</b>
1 Oliva, Ø 3 mm	<b>31-011-03</b>
1 Oliva, Ø 4 mm	<b>31-011-04</b>
1 Oliva, Ø 5 mm	<b>31-011-05</b>
1 Scatola metallica	<b>31-011-09</b>



## VARADY

**31-011-01** 45,0 cm, 17<sup>3</sup>/<sub>4</sub>"

Zugseil  
 Traction cable  
 Cable de tracción  
 Fune di trazione



## VARADY

<b>31-011-03</b>	Ø 3,0 mm
<b>31-011-04</b>	Ø 4,0 mm
<b>31-011-05</b>	Ø 5,0 mm

Olive  
 Olive  
 Oliva  
 Oliva



<b>31-013-02</b>	Ø 2,0 mm
<b>31-013-03</b>	Ø 3,0 mm
<b>31-013-04</b>	Ø 4,0 mm
<b>31-013-06</b>	Ø 6,0 mm
<b>31-013-07</b>	Ø 7,0 mm
<b>31-013-08</b>	Ø 8,5 mm
<b>31-013-10</b>	Ø 10,0 mm
<b>31-013-12</b>	Ø 12,0 mm
<b>31-013-14</b>	Ø 14,0 mm

**VOLLMAR**

**31-013-02 - 31-013-14** 50,0 cm, 19 3/4 "



<b>31-014-02</b>	Ø 2,0 mm
<b>31-014-03</b>	Ø 3,0 mm
<b>31-014-04</b>	Ø 4,0 mm
<b>31-014-05</b>	Ø 5,0 mm
<b>31-014-06</b>	Ø 6,0 mm
<b>31-014-07</b>	Ø 7,0 mm
<b>31-014-08</b>	Ø 8,0 mm
<b>31-014-09</b>	Ø 9,0 mm
<b>31-014-10</b>	Ø 10,0 mm
<b>31-014-12</b>	Ø 12,0 mm
<b>31-014-14</b>	Ø 14,0 mm

**VOLLMAR**

**31-014-02 - 31-014-14** 50,0 cm, 19 3/4 "



**VOLLMAR**

**31-012-00** 11,0 cm, 4 3/8 "



Ø 0,5 mm

<b>31-015-05</b>
<b>31-016-05</b>
<b>31-017-05</b>



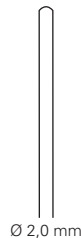
Ø 1,0 mm

<b>31-015-10</b>
<b>31-016-10</b>
<b>31-017-10</b>



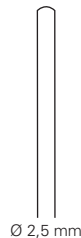
Ø 1,5 mm

<b>31-015-15</b>
<b>31-016-15</b>
<b>31-017-15</b>



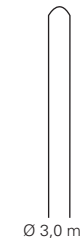
Ø 2,0 mm

<b>31-015-20</b>
<b>31-016-20</b>
<b>31-017-20</b>



Ø 2,5 mm

<b>31-015-25</b>
<b>31-016-25</b>
<b>31-017-25</b>



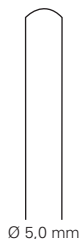
Ø 3,0 mm

<b>31-015-30</b>
<b>31-016-30</b>
<b>31-017-30</b>



Ø 4,0 mm

<b>31-015-40</b>
<b>31-016-40</b>
<b>31-017-40</b>



Ø 5,0 mm

<b>31-015-50</b>
<b>31-016-50</b>
<b>31-017-50</b>

biegsam  
 malleable  
 maleable  
 malleabile

**COOLEY**

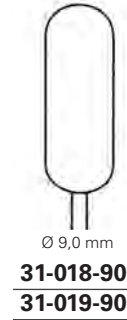
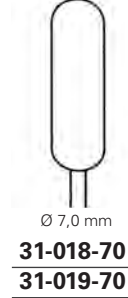
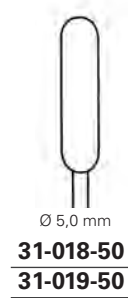
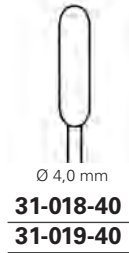
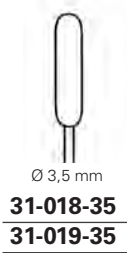
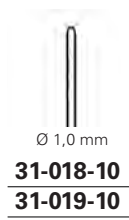
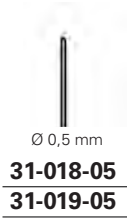
**31-015-05 - 31-015-50** 13,0 cm, 5 1/8 "

Aluminium Handgriff, biegsam  
 Aluminium handle, malleable  
 Manija del aluminio, maleable  
 Maniglia dell'aluminio, malleabile



**COOLEY**

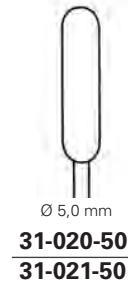
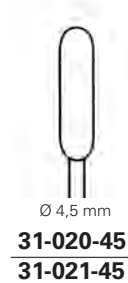
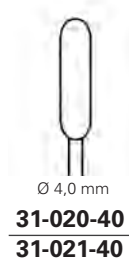
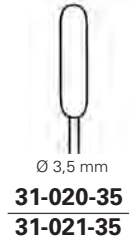
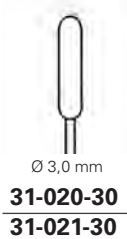
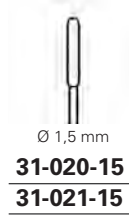
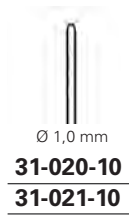
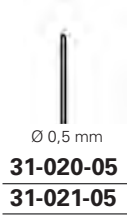
**31-016-05 - 31-016-50** 15,0 cm, 6 "  
**31-017-05 - 31-017-50** 20,0 cm, 8 "



biegsam  
 malleable  
 malleable  
 malleabile

### DE BAKERY

**31-018-05 - 31-018-90** 19,0 cm, 7 ½"  
**31-019-05 - 31-019-90** 35,0 cm, 13¾"



biegsam  
 malleable  
 malleable  
 malleabile

### GARRETT

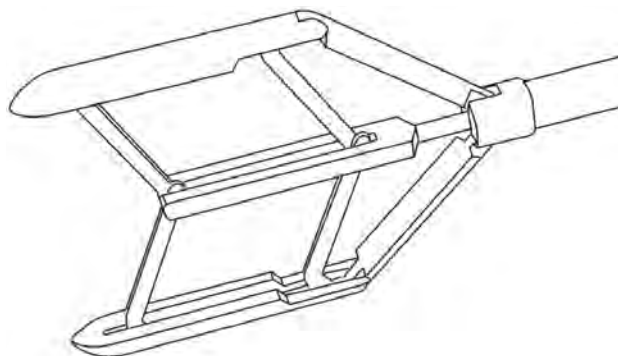
**31-020-05 - 31-020-50** 14,0 cm, 5 ½"  
**31-021-05 - 31-021-50** 21,0 cm, 8 ¼"

### GARRETT SET

**31-020-00** 14,0 cm, 5 ½"  
 Set 31-020-05 - 31-020-50

### GARRETT SET

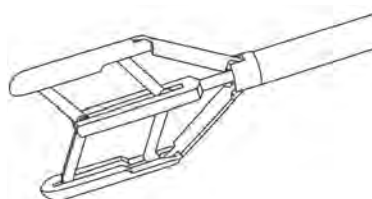
**31-021-00** 21,0 cm, 8 ¼"  
 Set 31-021-05 - 31-021-50



Spreizweite 8,0 - 42,0 mm  
blade opening 8,0 - 42,0 mm  
abertura 8,0 - 42,0 mm  
apertura 8,0 - 42,0 mm

## TUBBS

**31-030-00** 8,0 - 42,0 mm



Spreizweite 8,0 - 15,0 mm  
blade opening 8,0 - 15,0 mm  
abertura 8,0 - 15,0 mm  
apertura 8,0 - 15,0 mm

für Kinder  
for children  
para niños  
per bambini

## COOLEY

**31-032-00** 8,0 - 15,0 mm



zerlegbar  
 detachable  
 desmontable  
 smontabile

<b>31-034-02</b>	Ø 2,0 mm
<b>31-034-03</b>	Ø 3,0 mm
<b>31-034-04</b>	Ø 4,5 mm
<b>31-034-05</b>	Ø 5,0 mm
<b>31-034-06</b>	Ø 6,0 mm

<b>31-035-02</b>	Ø 2,0 mm
<b>31-035-03</b>	Ø 3,0 mm
<b>31-035-04</b>	Ø 4,5 mm
<b>31-035-05</b>	Ø 5,0 mm
<b>31-035-06</b>	Ø 6,0 mm

<b>31-036-02</b>	Ø 2,0 mm
<b>31-036-03</b>	Ø 3,0 mm
<b>31-036-04</b>	Ø 4,5 mm
<b>31-036-05</b>	Ø 5,0 mm
<b>31-036-06</b>	Ø 6,0 mm

<b>31-037-02</b>	Ø 2,0 mm
<b>31-037-03</b>	Ø 3,0 mm
<b>31-037-04</b>	Ø 4,5 mm
<b>31-037-05</b>	Ø 5,0 mm
<b>31-037-06</b>	Ø 6,0 mm

<b>31-038-02</b>	Ø 2,0 mm
<b>31-038-03</b>	Ø 3,0 mm
<b>31-038-04</b>	Ø 4,5 mm
<b>31-038-05</b>	Ø 5,0 mm
<b>31-038-06</b>	Ø 6,0 mm

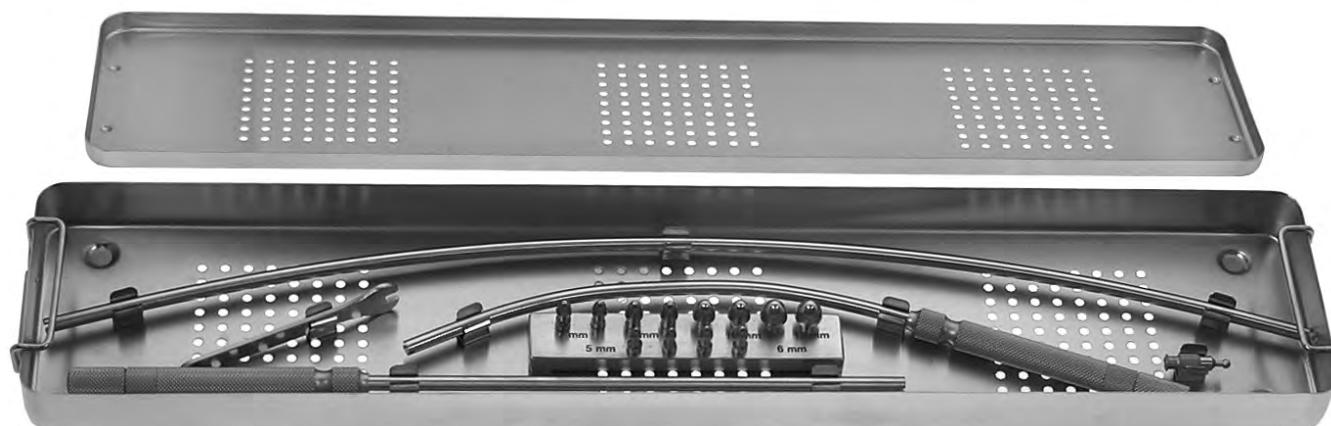
**31-034-02 - 31-034-06** 12,0 cm, 4 ¾ "

**31-035-02 - 31-035-06** 15,0 cm, 6 "

**31-036-02 - 31-036-06** 18,0 cm, 7 "

**31-037-02 - 31-037-06** 20,0 cm, 8 "

**31-038-02 - 31-038-06** 25,0 cm, 9 ¾ "



## SET

**31-040-00**

Satz komplett mit 3 Schäften, 2 Griffen und 12 Aufsätzen im Lagerungsbehälter  
 Set complete with 3 shafts, 2 handles and 12 tips in storage case  
 Juego completo con 3 vástagos, 2 mangos y 12 cabezas en caja metálica  
 Set completo, con 3 gambi, 2 mancini e 12 raccordi in contenitore metallico

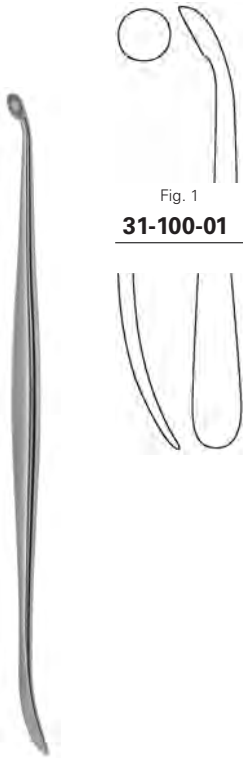


Fig. 1  
**31-100-01**

**PENFIELD**

**31-100-01** 17,5 cm, 7 "

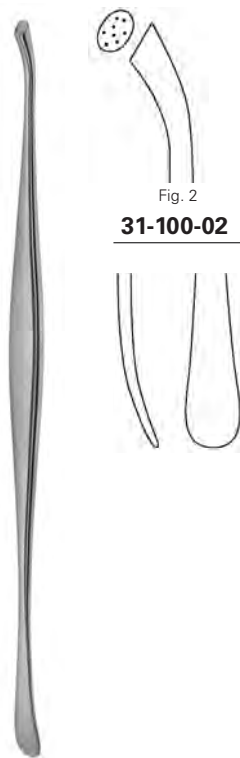


Fig. 2  
**31-100-02**

**PENFIELD**

**31-100-02** 19,5 cm, 7 ¾ "

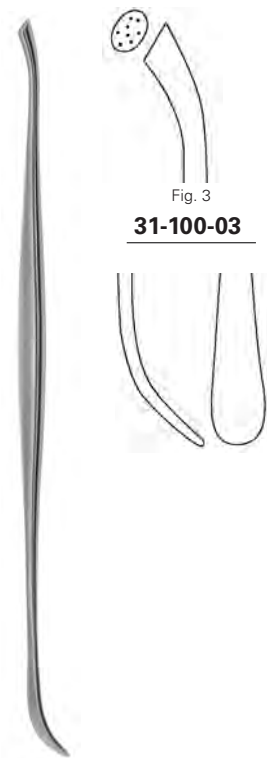


Fig. 3  
**31-100-03**

**PENFIELD**

**31-100-03** 19,5 cm, 7 ¾ "

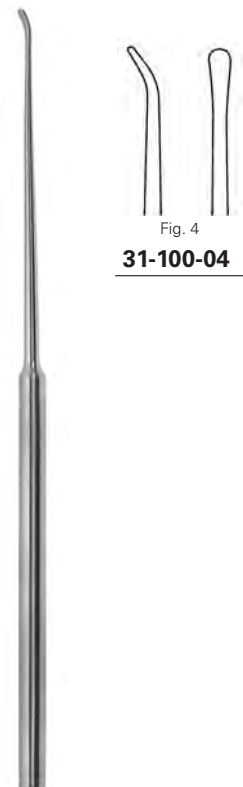


Fig. 4  
**31-100-04**

**PENFIELD**

**31-100-04** 20,5 cm, 8 "

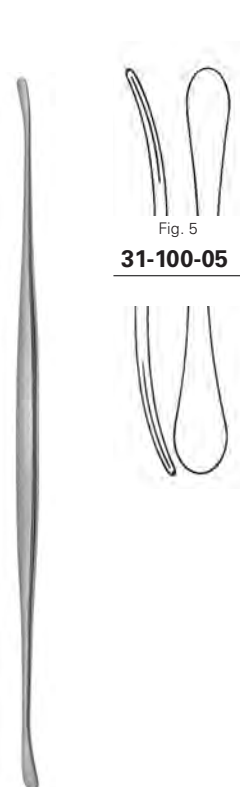
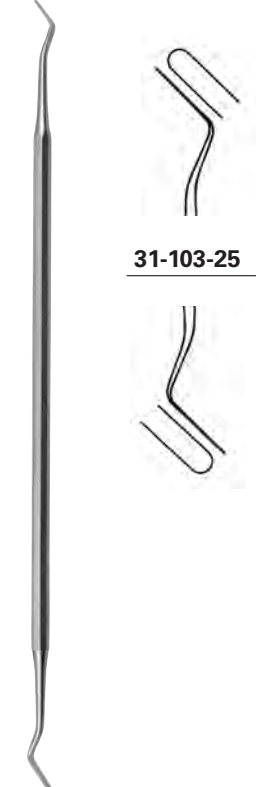


Fig. 5  
**31-100-05**

**PENFIELD**

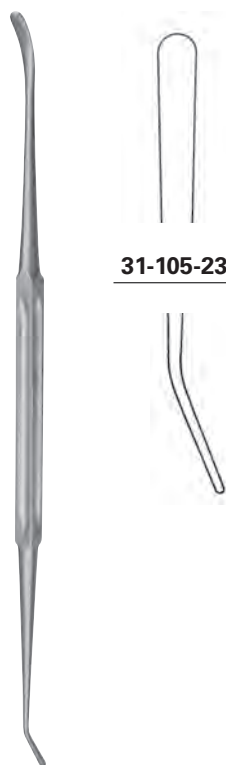
**31-100-05** 18,5 cm, 7 ¼ "



**31-103-25**

**WOODSON**

**31-103-25** 25,0 cm, 9 ¾ "

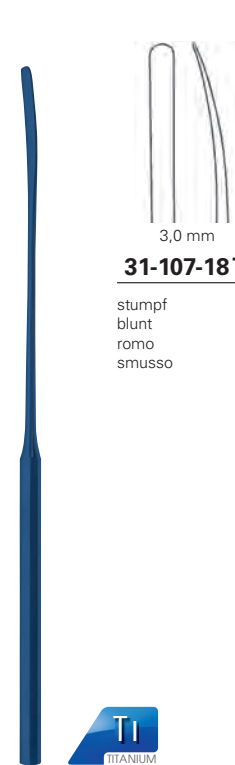


**31-105-23**



3,0 mm  
**31-107-18**  
**31-107-21**

stumpf  
 blunt  
 romo  
 smusso



3,0 mm  
**31-107-18T**

stumpf  
 blunt  
 romo  
 smusso



**PENNYBACKER**

**31-105-23** 23,0 cm, 9"

**31-107-18** 18,5 cm, 7 ¼"  
**31-107-21** 21,5 cm, 8 ½"

**31-107-18 T** 18,5 cm, 7 ¼"



**31-108-14**

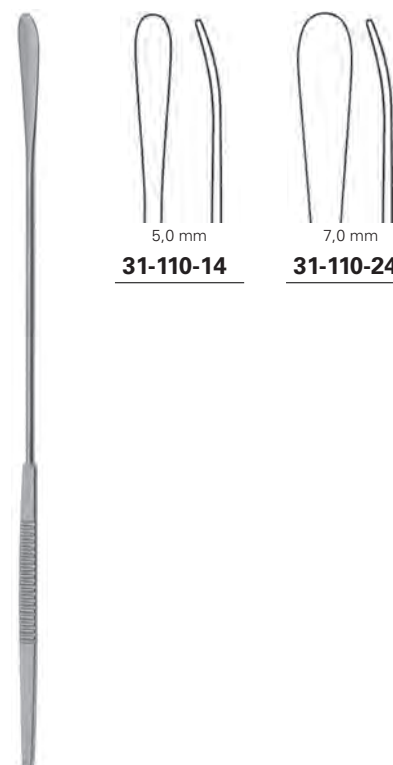
stumpf  
 blunt  
 romo  
 smusso

**31-108-23**

stumpf  
 blunt  
 romo  
 smusso



**31-109-24**



5,0 mm  
**31-110-14**

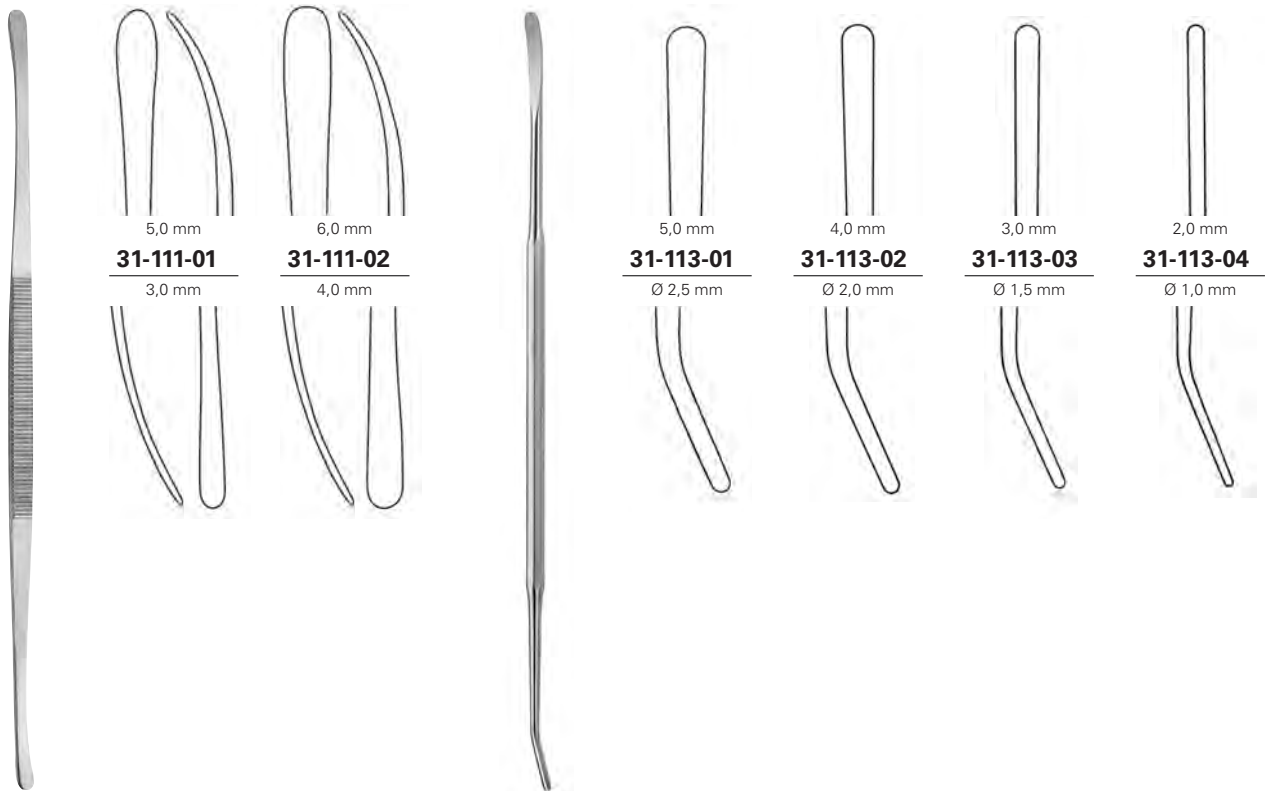
7,0 mm  
**31-110-24**

**SCHMID**

**31-108-14** 14,0 cm, 5 ½"  
**31-108-23** 23,5 cm, 9 ¼"

**DAVIS**  
**31-109-24** 24,5 cm, 9 ⅔"

**31-110-14** 14,0 cm, 5 ½"  
**31-110-24** 24,0 cm, 9 ½"

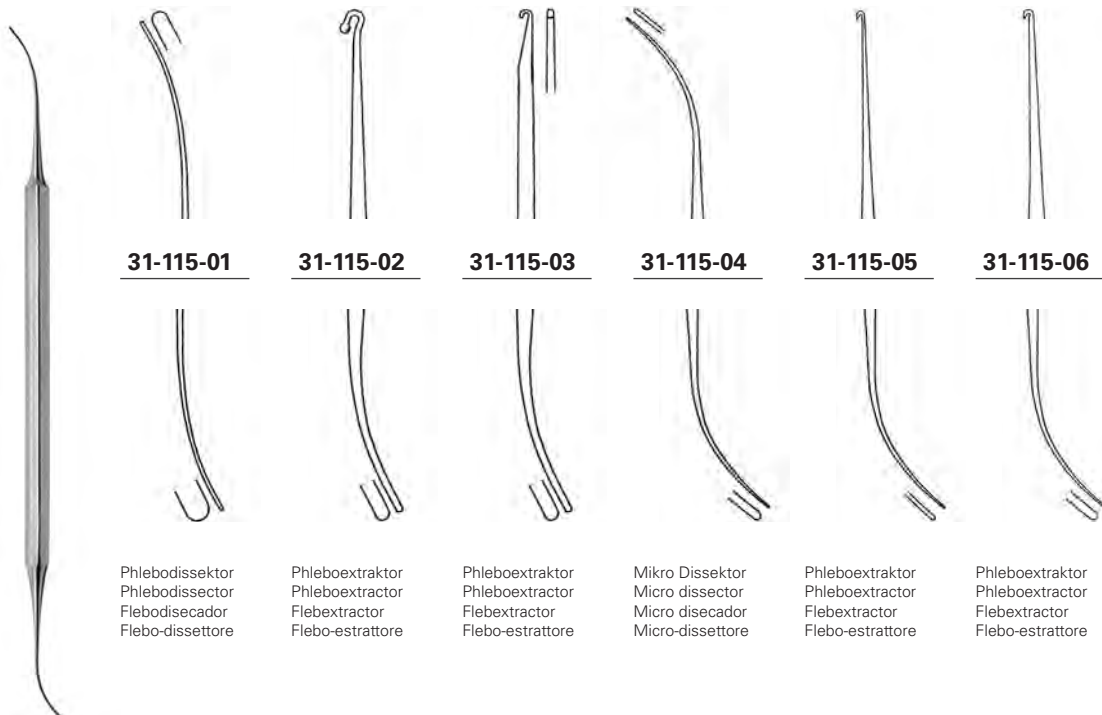


**TOENNIS**

**31-111-01 - 31-111-02** 24,0 cm, 9 ½"

**ROBB**

**31-113-01 - 31-113-04** 24,0 cm, 9 ½"



Phlebo-dissektor  
 Phlebo-dissector  
 Flebodisecador  
 Flebo-dissettore

Phleboextraktor  
 Phleboextractor  
 Fleboextractor  
 Flebo-estrattore

Phleboextraktor  
 Phleboextractor  
 Flebextractor  
 Flebo-estrattore

Mikro Dissektor  
 Micro dissector  
 Micro disecador  
 Micro-dissettore

Phleboextraktor  
 Phleboextractor  
 Flebextractor  
 Flebo-estrattore

Phleboextraktor  
 Phleboextractor  
 Flebextractor  
 Flebo-estrattore

**VARADY**

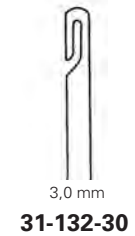
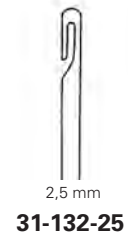
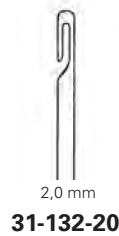
**31-115-01 - 31-115-06** 18,0 cm, 7"





Ø 3,2 mm  
**31-130-32**

Ø 6,4 mm  
**31-130-64**



**RUMEL-BELMONT**

**31-130-32** 27,0 cm, 10<sup>3</sup>/<sub>4</sub> "  
**31-130-64** 30,5 cm, 12 "

**RUMEL-BELMONT**

**31-132-20 - 31-132-30** 26,0 cm, 10<sup>1</sup>/<sub>4</sub> "



**COOLEY**

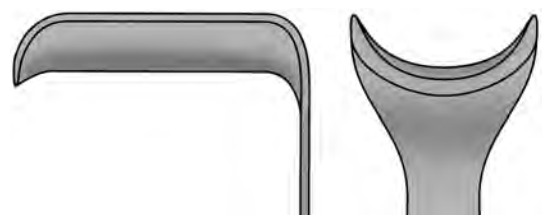
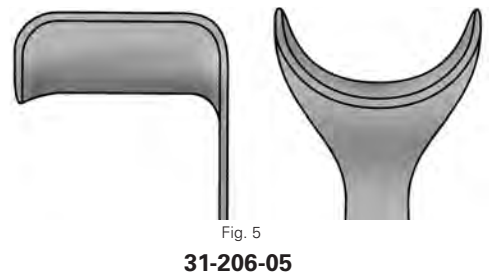
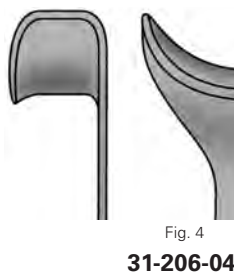
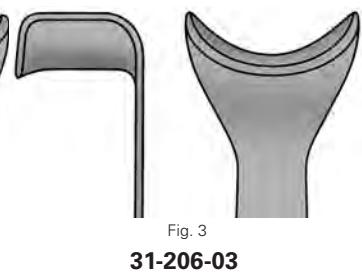
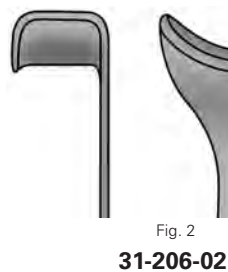
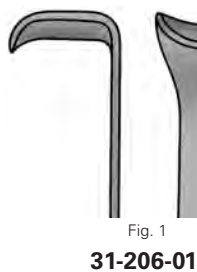
**COOLEY**

**31-200-24** 26,0 cm, 10 3/4"

<b>31-201-24</b>	26,0 cm, 10 3/4"
<b>31-203-24</b>	24,0 cm, 9 1/2"
<b>31-204-24</b>	24,0 cm, 9 1/2"

**COOLEY**

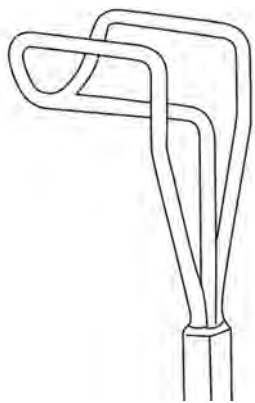
**31-202-25** 27,5 cm, 10 3/4"



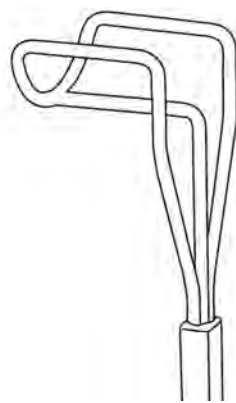
Schaft flexibel  
 Flexible shaft  
 Vástago flexible  
 Asta flessibile

**ROSS**

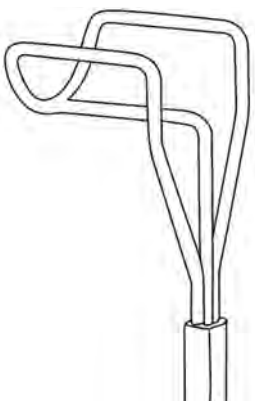
**31-206-01 - 31-206-06** 27,0 cm, 10 3/4"



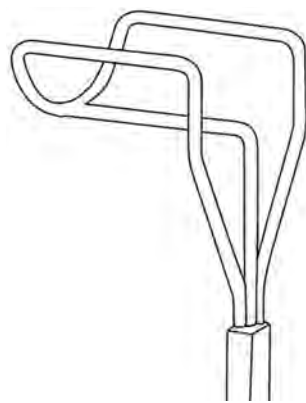
17 x 21 mm  
**31-208-01**



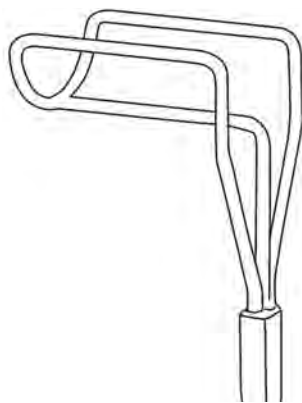
16 x 23 mm  
**31-208-02**



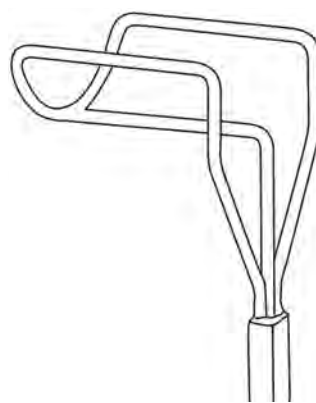
20 x 25 mm  
**31-208-03**



24 x 27 mm  
**31-208-04**



28 x 20 mm  
**31-208-05**



28 x 29 mm  
**31-208-06**



Schaft flexibel  
 Flexible shaft  
 Vástago flexible  
 Asta flessibile

Epikardial Retraktoren  
 Epicardial retractors  
 Retractores epicárdicos  
 Divaricatori epicardici



<b>31-210-01</b>	25,0 mm
<b>31-210-02</b>	28,0 mm
<b>31-210-03</b>	38,0 mm
<b>31-210-04</b>	54,0 mm


**BOROWSKI**

**31-208-01 - 31-208-06** 27,0 cm, 10<sup>3</sup>/<sub>4</sub>"



**HEART-GATE**  
**31-300-01** Ø 5,0 mm  
 Schere, gebogen 15°  
 Scissors, curved 15°  
 Tijera, curva 15°  
 Forbici, curva 15°



**HEART-GATE**   
**31-300-01 W** Ø 5,0 mm  
 Schere, gebogen 15°  
 Scissors, curved 15°  
 Tijera, curva 15°  
 Forbici, curva 15°




**HEART-GATE**  
**31-300-02** Ø 5,0 mm  
 Schere, gebogen 30°  
 Scissors, curved 30°  
 Tijera, curva 30°  
 Forbici, curva 30°



**HEART-GATE**  
**31-301-01** Ø 3,5 mm  
 Mikroschere, aufgebogen 45°  
 Micro Scissors, curved up 45°  
 Micro-tijera, curva hacia arriba 45°  
 Micro-forbici, curva verso l'alto 45°



**HEART-GATE**   
**31-301-01 W** Ø 3,5 mm  
 Mikroschere, aufgebogen 45°  
 Micro Scissors, curved up 45°  
 Micro-tijera, curva hacia arriba 45°  
 Micro-forbici, curva verso l'alto 45°



**HEART-GATE**  
**31-301-02** Ø 3,5 mm  
 Mikroschere, aufgebogen 125°  
 Micro Scissors, curved up 125°  
 Micro-tijera, curva hacia arriba 125°  
 Micro-forbici, curva verso l'alto 125°



**HEART-GATE**   
**31-302-03** Ø 5,0 mm  
 Nadelhalter, gerade, mit Sperre  
 Needle holder, straight, with ratchet  
 Porta-aguja, recta, con cremallera  
 Portaghi, retta, con cremagliera



**HEART-GATE**  
**31-303-01** Ø 5,0 mm  
 Faßzange, gerade  
 Grasping forceps, straight  
 Pinzas para agarrar, recta  
 Pinze da presa, retta



**HEART-GATE**   
**31-303-02** Ø 5,0 mm  
 De Bakey Faßzange fein, gerade  
 De Bakey grasping forceps, fine, straight  
 De Bakey Pinzas para agarrar, fino, recta  
 De Bakey Pinze da presa, fino, retta

mit Spülanschluss zur Innenreinigung des Schaftes, Aluminium Handgriff  
 with connection to clean and rinse the shaft, Aluminium handle  
 con conexión de irrigación para limpiar el tubo interior, Manija del aluminio  
 con attacco per la pulizia interna dell'asta, Maniglia dell'aluminio

**HEART-GATE**   
**31-300-01 - 31-314-02** 36,0 cm, 14 3/4"



**31-300-02 W** Ø 5,0 mm

Schere, gebogen 30°  
 Scissors, curved 30°  
 Tijera, curva 30°  
 Forbici, curva 30°



**31-300-03** Ø 5,0 mm

Schere, gebogen 70°  
 Scissors, curved 70°  
 Tijera, curva 70°  
 Forbici, curva 70°



**31-300-03 W** Ø 5,0 mm

Schere, gebogen 70°  
 Scissors, curved 70°  
 Tijera, curva 70°  
 Forbici, curva 70°



**31-301-02 W** Ø 3,5 mm

Mikroschere, aufgebogen 125°  
 Micro Scissors, curved up 125°  
 Micro-tijera, curva hacia arriba 125°  
 Micro-forbici, curva verso l'alto 125°



**31-302-01** Ø 5,0 mm

Nadelhalter, gerade, mit Sperre  
 Needle holder, straight, with ratchet  
 Porta-aguja, recta, con cremallera  
 Portaghi, retta, con cremagliera



**31-302-02** Ø 5,0 mm

Nadelhalter, gebogen, mit Sperre  
 Needle holder, curved, with ratchet  
 Porta-aguja, curva, con cremallera  
 Portaghi, curva, con cremagliera



1,5 x 15,0 mm



**31-303-03** Ø 3,5 mm

De Bakey Faßzange, fein, aufgebogen  
 De Bakey Grasping forceps, fine, curved up  
 De Bakey Pinzas para agarrar, fino, curva hacia arriba  
 De Bakey Pinze da presa, fino, curva verso l'alto



3,0 x 14,5 mm



**31-303-04** Ø 5,0 mm

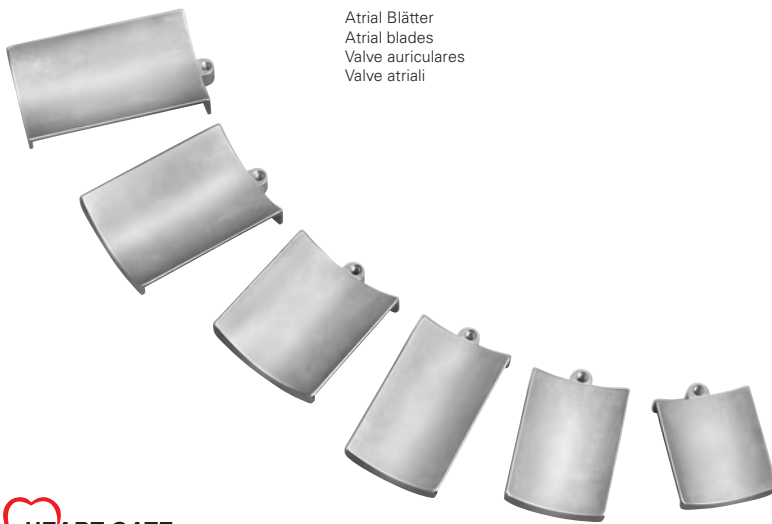
Resano Faßzange, gerade  
 Resano grasping forceps, straight  
 Resano Pinzas para agarrar, recta  
 Resano Pinze da presa, retta



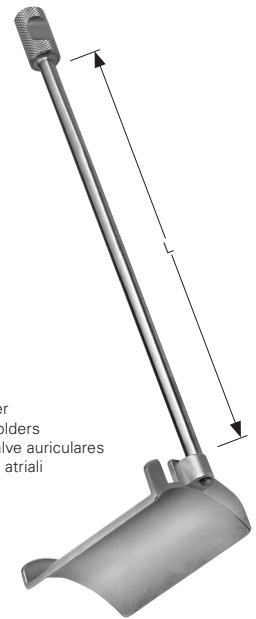
**31-304-01** Ø 5,0 mm

Knotenschieber, aufgebogen  
 Knot pusher, curved up  
 Desplazador del nudo, curva hacia arriba  
 Chivistello del nodo, curva verso l'alto





Atrial Blätter  
 Atrial blades  
 Valve auriculares  
 Valve atriali



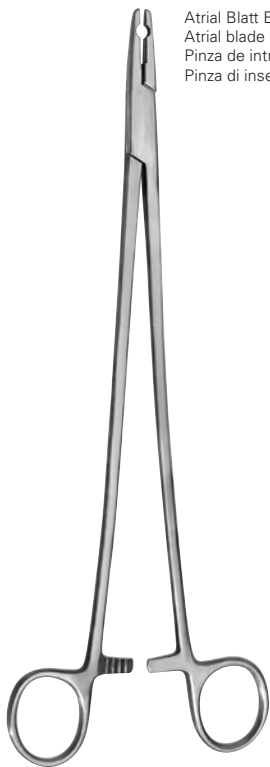
Atrial Blatthalter  
 Atrial blades holders  
 Soportes de valve auriculares  
 Supporto valve atriali



<b>31-310-01</b>	40 x 35 mm
<b>31-310-02</b>	50 x 35 mm
<b>31-310-03</b>	60 x 35 mm
<b>31-310-04</b>	50 x 40 mm
<b>31-310-05</b>	60 x 40 mm
<b>31-310-06</b>	70 x 40 mm



<b>31-310-10</b>	16,0 cm, 6 1/4 "
<b>31-310-11</b>	22,0 cm, 6 3/4 "



Atrial Blatt Einführungszange  
 Atrial blade introducer  
 Pinza de introducción de la lámina auricular  
 Pinza di inserimento valve atriali



**31-310-00 SET**

Komplett bestehend aus:

Complete consisting of:

1 Atrial Blatt 40 x 35 mm	<b>31-310-01</b>
1 Atrial Blatt 50 x 35 mm	<b>31-310-02</b>
1 Atrial Blatt 60 x 35 mm	<b>31-310-03</b>
1 Atrial Blatt 50 x 40 mm	<b>31-310-04</b>
1 Atrial Blatt 60 x 40 mm	<b>31-310-05</b>
1 Atrial Blatt 70 x 40 mm	<b>31-310-06</b>
1 Blatthalter 16,0 cm	<b>31-310-10</b>
1 Blatthalter 22,0 cm	<b>31-310-11</b>
1 Einführungszange	<b>31-310-20</b>

1 Atrial blade 40 x 35 mm	<b>31-310-01</b>
1 Atrial blade 50 x 35 mm	<b>31-310-02</b>
1 Atrial blade 60 x 35 mm	<b>31-310-03</b>
1 Atrial blade 50 x 40 mm	<b>31-310-04</b>
1 Atrial blade 60 x 40 mm	<b>31-310-05</b>
1 Atrial blade 70 x 40 mm	<b>31-310-06</b>
1 Balde holder 16,0 cm	<b>31-310-10</b>
1 Balde holder 22,0 cm	<b>31-310-11</b>
1 Blade introducer	<b>31-310-20</b>

Completo compuesto de:

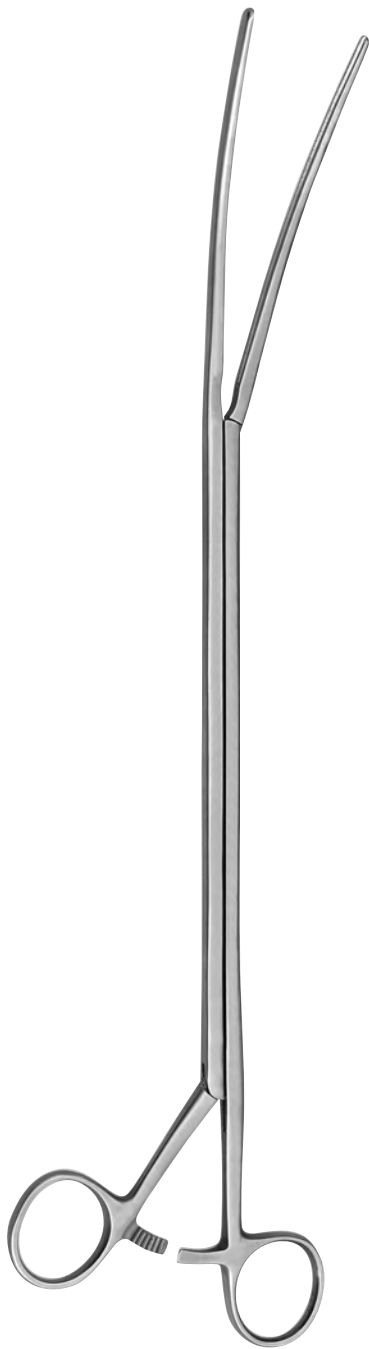
Completo composto da:

1 Valve auric. 40 x 35 mm	<b>31-310-01</b>
1 Valve auric. 50 x 35 mm	<b>31-310-02</b>
1 Valve auric. 60 x 35 mm	<b>31-310-03</b>
1 Valve auric. 50 x 40 mm	<b>31-310-04</b>
1 Valve auric. 60 x 40 mm	<b>31-310-05</b>
1 Valve auric. 70 x 40 mm	<b>31-310-06</b>
1 Soportes 16,0 cm	<b>31-310-10</b>
1 Soportes 22,0 cm	<b>31-310-11</b>
1 Pinza de introducción	<b>31-310-20</b>

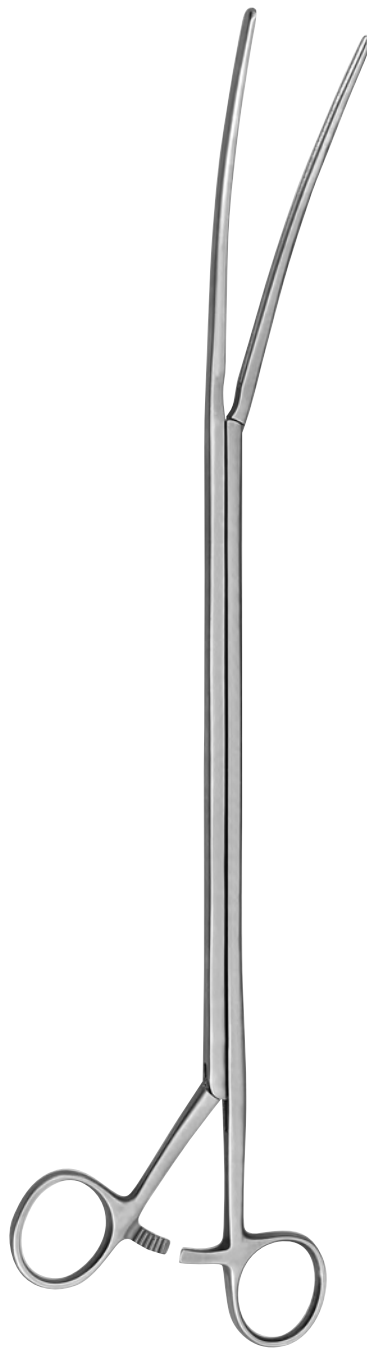
1 Valve atriali 40 x 35 mm	<b>31-310-01</b>
1 Valve atriali 50 x 35 mm	<b>31-310-02</b>
1 Valve atriali 60 x 35 mm	<b>31-310-03</b>
1 Valve atriali 50 x 40 mm	<b>31-310-04</b>
1 Valve atriali 60 x 40 mm	<b>31-310-05</b>
1 Valve atriali 70 x 40 mm	<b>31-310-06</b>
1 Supporto valve 16,0 cm	<b>31-310-10</b>
1 Supporto valve 22,0 cm	<b>31-310-11</b>
1 Pinza di inserimento	<b>31-310-20</b>



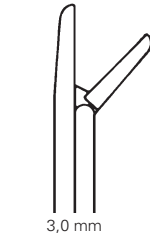
<b>31-310-20</b>	27,0 cm, 10 3/4 "
------------------	-------------------



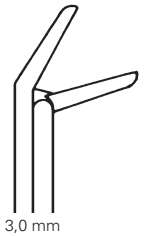
**HEART-GATE**  
 ATRAUMA  
**31-311-01** 35,5 cm, 14"



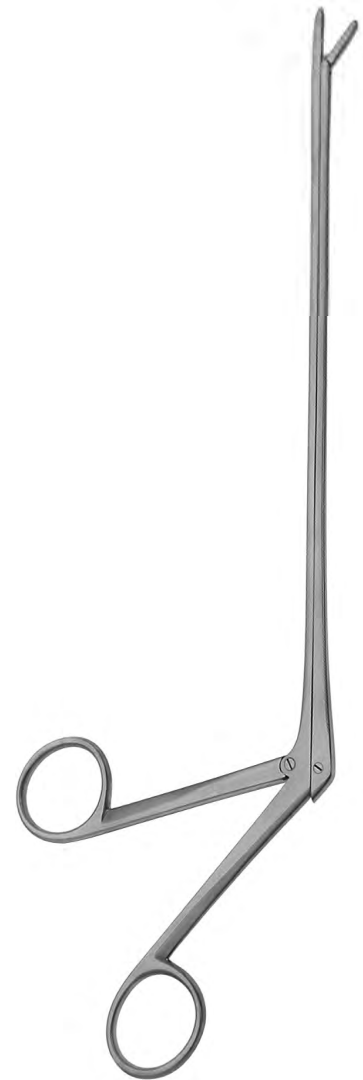
**HEART-GATE**  
 1 ATRAUMA  
**31-311-03** 32,0 cm, 12 1/4"  
**31-311-02** 35,0 cm, 13 3/4"



**31-320-03**



**31-321-03**



**HEART-GATE**  
**31-320-03** 30,0 cm, 11 3/4"  
**31-321-03** 30,0 cm, 11 3/4"



**31-312-01**



**31-312-01**



1,4 mm  
**31-312-02**



2,0 mm  
**31-312-03**

Nerv- und Gefäßhaken  
 Nerve and vessel hooks  
 Ganchitos para nervios y vasos  
 Unicini pere nervi e vasi



**31-313-01**



Fadenfänger  
 Ligature catcher  
 Portas ligaduras  
 Porta-legature



**31-314-01**



Magnetstab  
 Magnet bar  
 Imán de barra  
 Magnete di barra



**31-312-01 - 31-312-03** 36,0 cm, 14<sup>3</sup>/<sub>4</sub>"

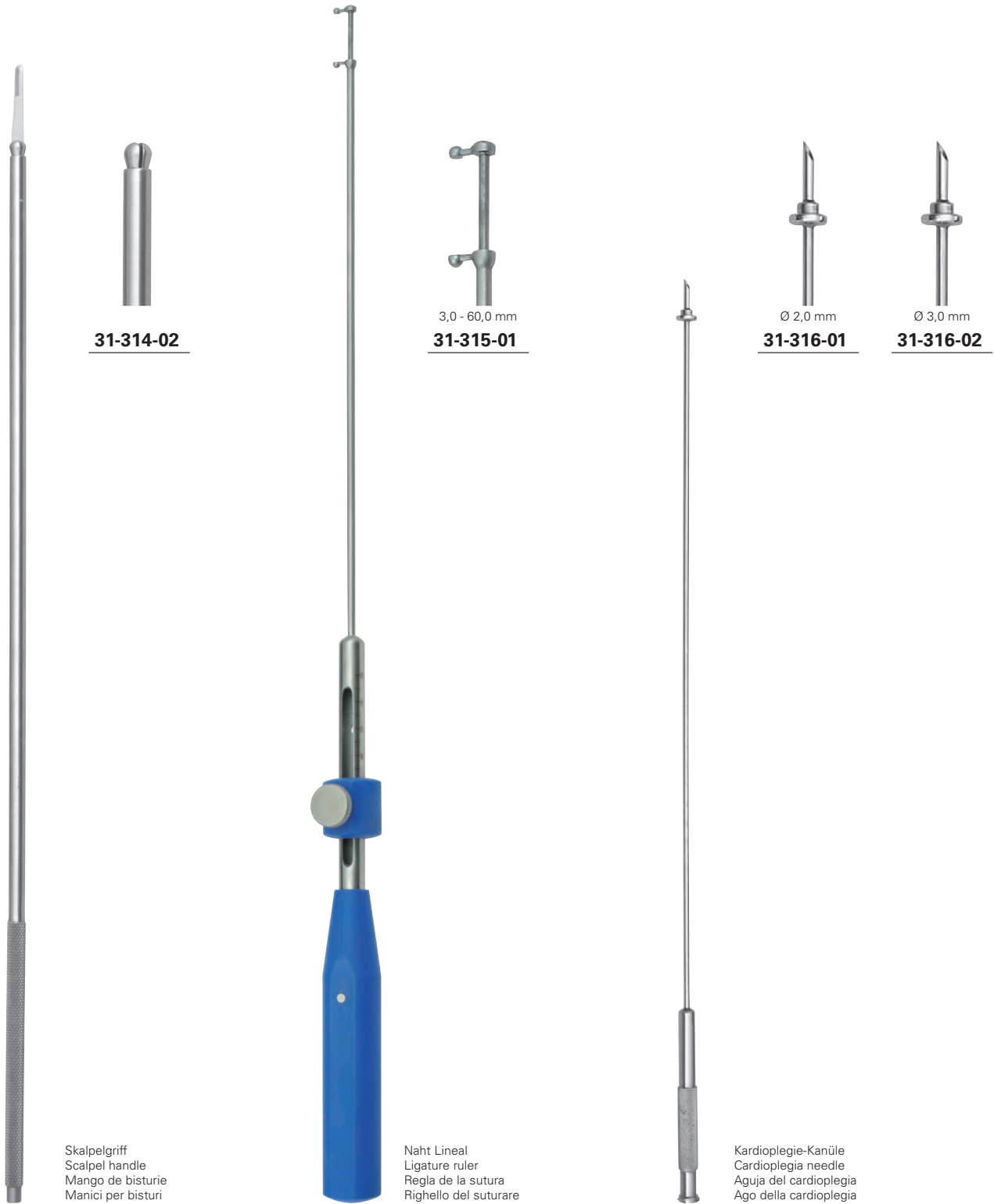


**31-313-01** 36,0 cm, 14<sup>3</sup>/<sub>4</sub>"



**31-314-01** 36,0 cm, 14<sup>3</sup>/<sub>4</sub>"





**31-314-02**

3,0 - 60,0 mm  
**31-315-01**


Ø 2,0 mm  
**31-316-01**


Ø 3,0 mm  
**31-316-02**

Skalpelgriff  
 Scalpel handle  
 Mango de bisturie  
 Manici per bisturi

Naht Lineal  
 Ligature ruler  
 Regla de la sutura  
 Righello del suturare

Kardioplegie-Kanüle  
 Cardioplegia needle  
 Aguja del cardioplegia  
 Ago della cardioplegia

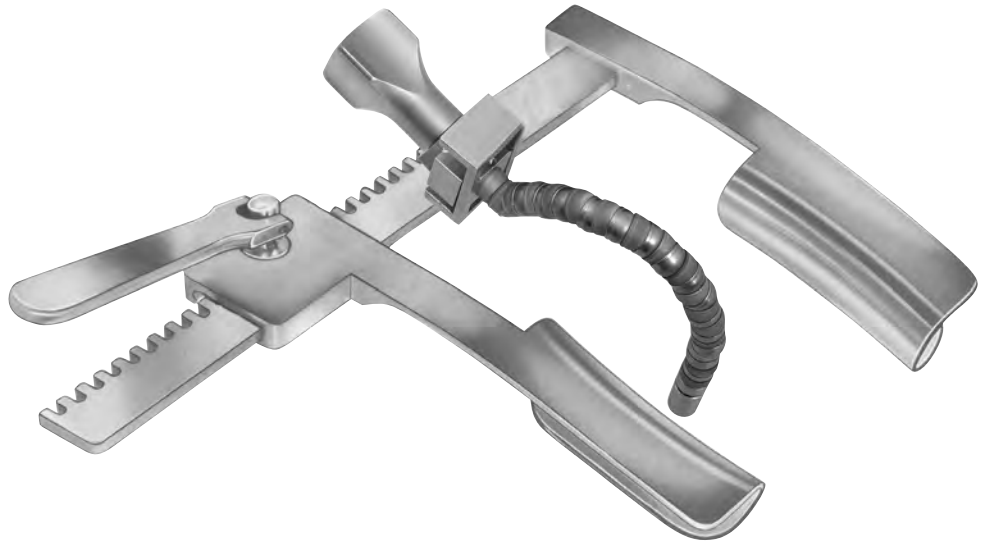
**HEART-GATE**  Fig. 61-69  
**31-314-02** 36,0 cm, 14 3/4"

**HEART-GATE**  **PP** PROPYLUX®  
**31-315-01** 40,0 cm, 15 3/4"

**HEART-GATE**   
**31-316-01 - 31-316-02** 31,0 cm, 12 1/4"



flexibel  
flexible  
flexible  
flessibile



Verwendbar mit jeglichen Sternal Sperrer Systemen  
 Attachable to any sternal retractor systems  
 Conectable a cualesquiera sistema retractor externo  
 Adattabile a qualsiasi sistema di retrattore sternale

**31-400-00** 27,0 cm, 10<sup>3</sup>/<sub>4</sub>''

Endoskope Halterung  
 Endoscope holding device  
 Equipo de endoscopia transportable  
 Porta endoscopio

Stabilisator Fuß  
 stabilizing foot  
 Estabilizador de pie  
 Piede stabilizzatore

Atrial Haken  
 Atrial Retractor  
 Seperador atrio  
 Divaricatori atrio



**31-410-02** Ø 2,7 mm  
**31-410-04** Ø 4,0 mm  
**31-410-05** Ø 5,0 mm  
**31-410-10** Ø 10,0 mm



**31-411-01** 30,0 mm  
**31-411-02** 40,0 mm



**31-415-20** 19 x 27 mm  
**31-415-35** 29 x 27 mm  
**31-415-45** 39 x 44 mm



**31-600-12** 12,0 cm, 4  $\frac{3}{8}$  "



**31-602-18** 18,0 cm, 7 "



**31-603-10** 10,0 cm, 4 "



**31-604-13** 13,0 cm, 5  $\frac{1}{8}$  "



**31-606-15** 15,5 cm, 6  $\frac{1}{8}$  "



**CASPAR**

**31-608-18** 18,0 cm, 7 "



**31-610-20** 20,0 cm, 8 "



Fig.  
61-69

**31-611-13** 13,0 cm, 5 1/8"



Ti  
TITANIUM  
Fig.  
61-69

**31-611-13 T** 13,5 cm, 5 1/4"



Fig.  
61-69

**LANDOLT**

**31-611-21** 21,0 cm, 8 1/4"

**31-613-25** 25,0 cm, 9 3/4"



horizontal  
horizontal  
horizontal  
orizzontale

Fig.  
18-36D

**31-615-21** 20,0 cm, 8 1/8"



vertical  
vertical  
vertical  
verticale

Fig.  
18-36D

**31-616-21** 20,0 cm, 8 1/8"



Griff mit Spannutter  
 Handle with chuck  
 Asa con mandril de sujeción  
 Manico con mandrino



**JACOBSON**

**31-650-00** 10,5 cm, 4 1/4"

Gefäßmesser  
 Vessel knife  
 Cuchillos para vasos  
 Bisturi per vasi



**JACOBSON**

**31-650-01** 9,5 cm, 3 3/4"



**31-660-16**

Gefäßspreizer  
 Vesselspreader  
 Retractores vasculares  
 Divaricatore vasi



**BIEMER**

**31-660-16** 16,0 cm, 6 1/4"



Ø 0,5 mm

**31-663-05**



Ø 1,0 mm

**31-663-10**



Ø 1,5 mm

**31-663-15**



Gefäßdilatoren  
 Vessel dilators  
 Dilatadores vasculares  
 Dilatatori vascolari

**31-663-05 - 31-663-15** 12,5 cm, 5"



**JACOBSON**

**31-664-18 - 31-666-18** 18,5 cm, 7 1/4"



**31-664-18**

Knopfsonde  
 Buttoned probe  
 Sonda abotonata  
 Sonda bottonuta



**31-665-18**

Doppelsonde  
 Twin probe  
 Sonda doble  
 Sond doppia



**31-666-18**

Fadengabel  
 Ligature pusher  
 Empujador de sutura  
 Punzone per sutura



**31-664-18 T**

Knopfsonde  
Buttoned probe  
Sonda abotonata  
Sonda bottonuta

**31-666-18 T**

Fadengabel  
Ligature pusher  
Empujador de sutura  
Punzone per sutura

**31-667-23**

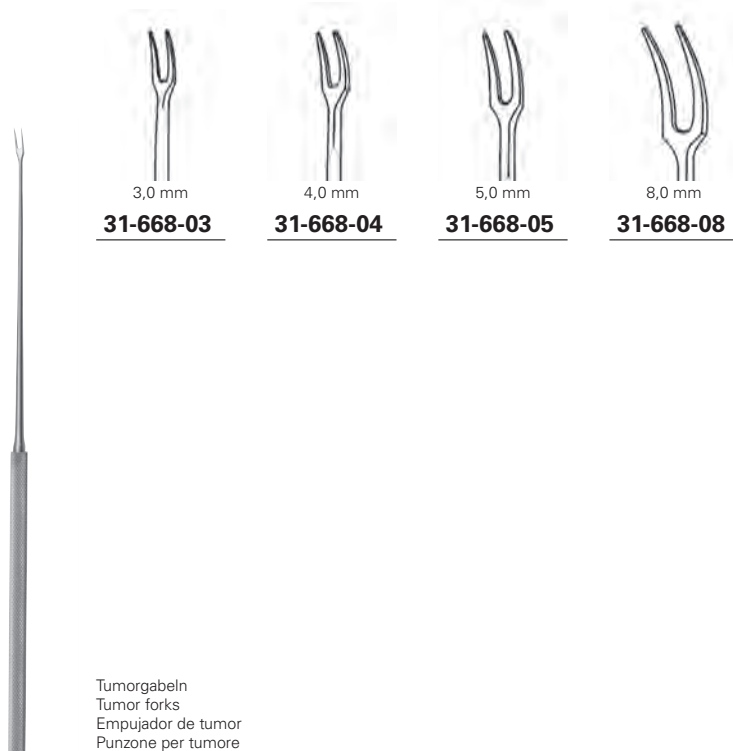
Fadengabel  
Ligature pusher  
Empujador de sutura  
Punzone per sutura

**JACOBSON**

**31-664-18 T - 31-666-18 T** 18,5 cm, 7 ¼"

**CASPAR**

**31-667-23** 23,0 cm, 9"



3,0 mm  
**31-668-03**

4,0 mm  
**31-668-04**

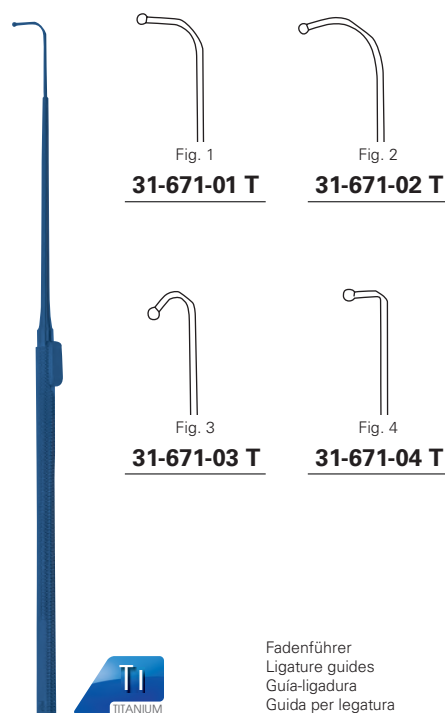
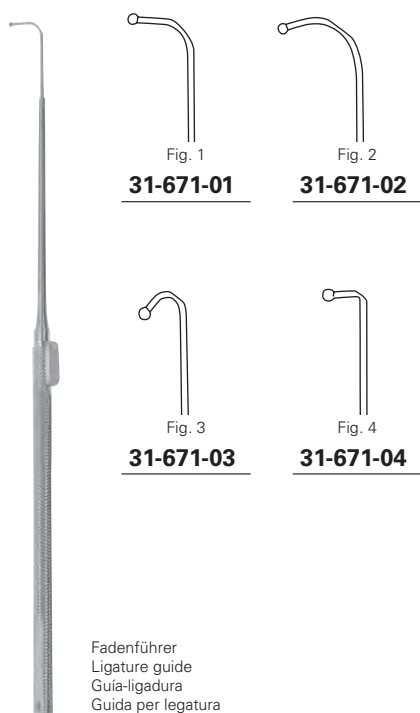
5,0 mm  
**31-668-05**

8,0 mm  
**31-668-08**

Tumorgabeln  
Tumor forks  
Empujador de tumor  
Punzone per tumore

**OKONEK-YASARGIL**

**31-668-03 - 31-668-08** 23,0 cm, 9"

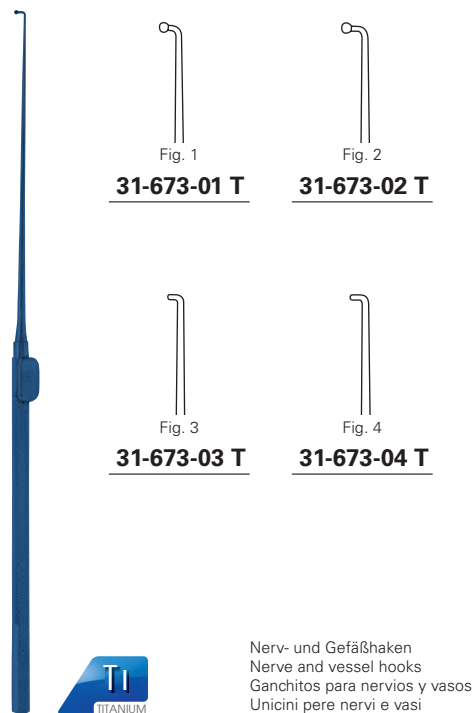
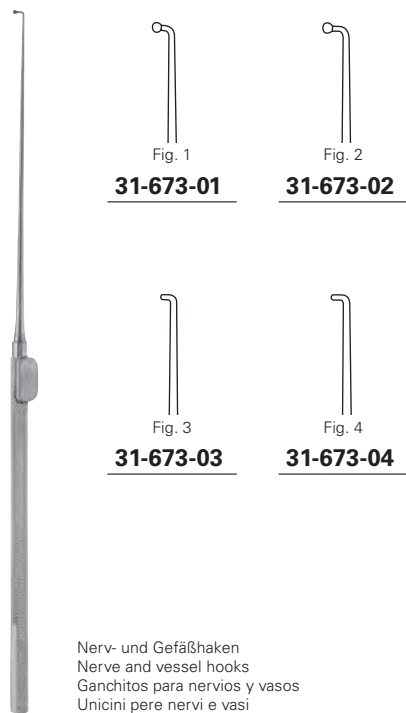


### YASARGIL

**31-671-01 - 31-671-04** 18,5 cm, 7 ¼"

### YASARGIL

**31-671-01 T - 31-671-04 T** 18,5 cm, 7 ¼"



### KRAYENBUEHL

**31-673-01 - 31-673-04** 18,5 cm, 7 ¼"

### KRAYENBUEHL

**31-673-01 T - 31-673-04 T** 18,5 cm, 7 ¼"



Ø 1,8 mm

**31-674-18**

Gewebekralle  
Tissue Pick  
Garra para tejidos  
Artiglio per tessuti

**31-674-18** 18,5 cm, 7 ¼"



**31-675-01**

Scharfes Häkchen  
Sharp Hook  
Ganchito muy fino  
Uncino delicato

**31-675-01** 18,5 cm, 7 ¼"



**31-675-01 T**

Scharfes Häkchen  
Sharp Hook  
Ganchito muy fino  
Uncino delicato



**31-675-01 T** 18,5 cm, 7 ¼"



90°

**31-675-02**

Scharfes Häkchen  
Sharp Hook  
Ganchito muy fino  
Uncino delicato

**31-675-02** 18,5 cm, 7 ¼"



90°

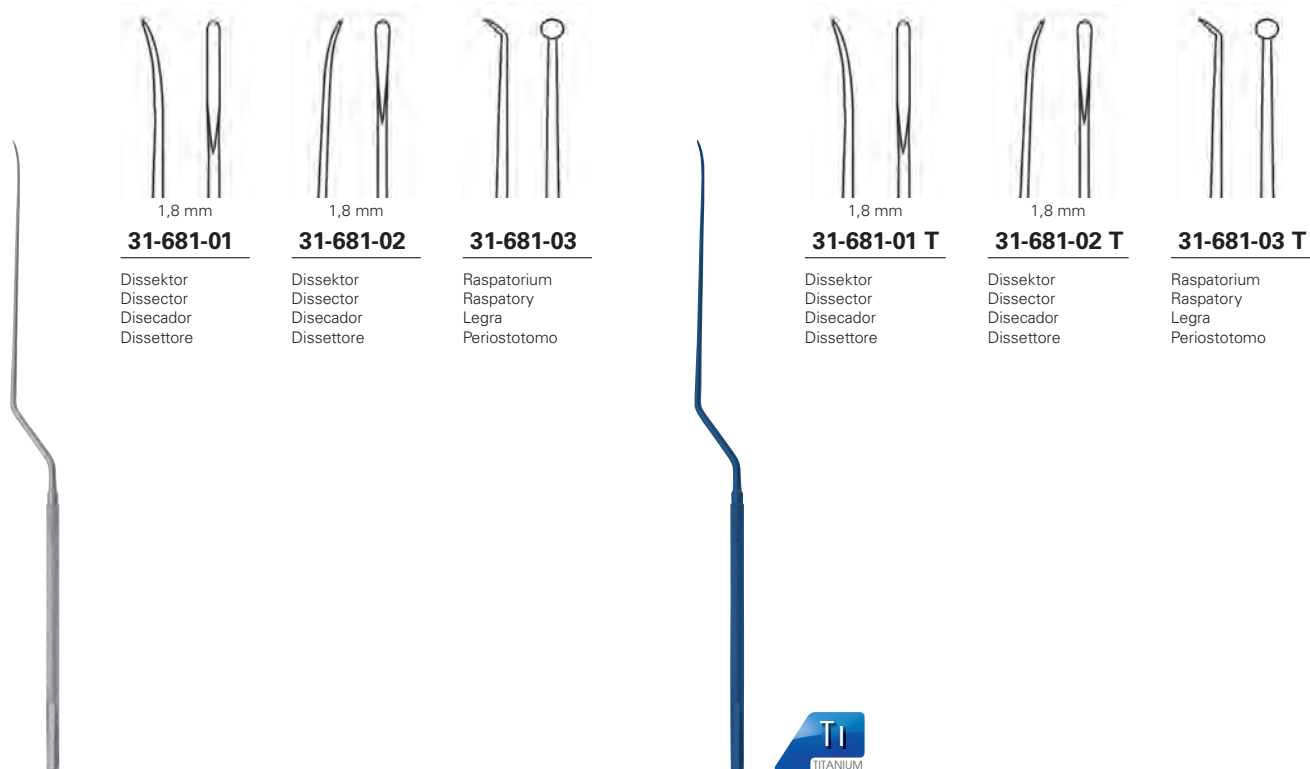
**31-675-02 T**

Scharfes Häkchen  
Sharp Hook  
Ganchito muy fino  
Uncino delicato



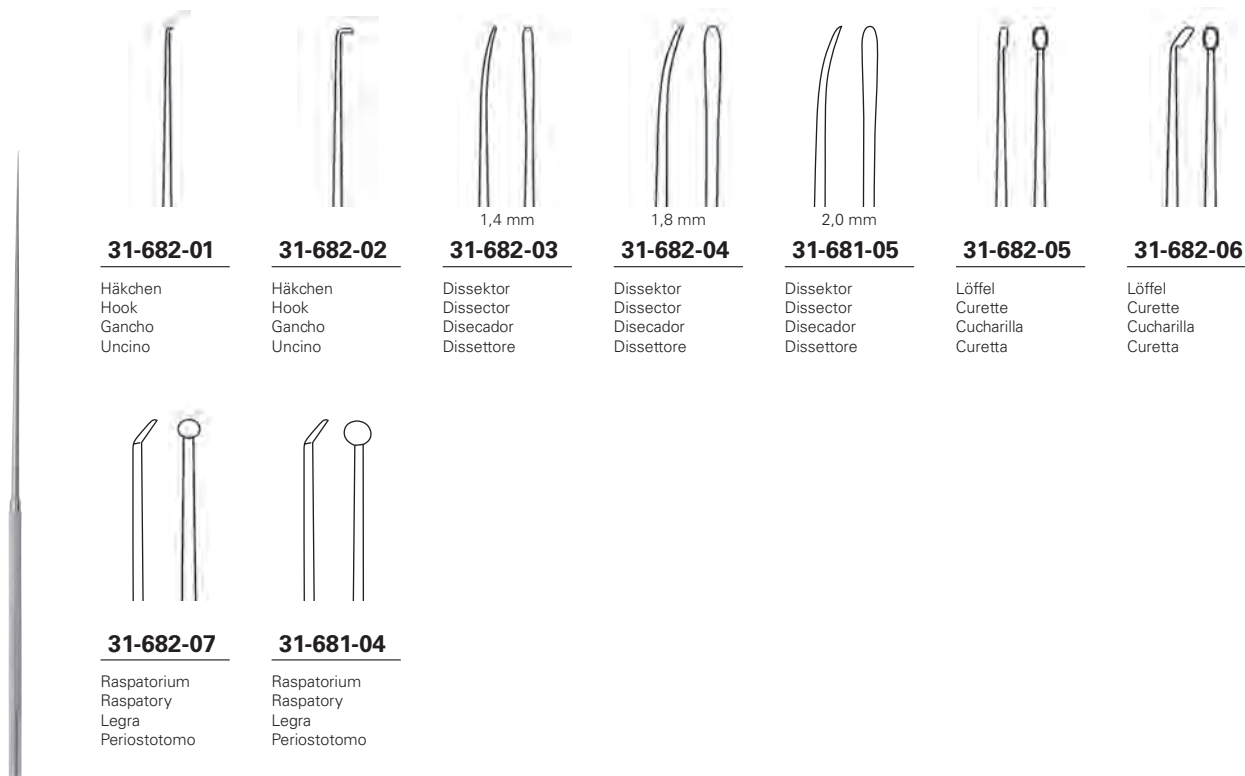
**31-675-02 T** 18,5 cm, 7 ¼"





**31-681-01 - 31-681-03** 23,0 cm, 9"

**31-681-01 T - 31-681-03 T** 23,0 cm, 9"



**31-681-04 - 31-682-07** 23,0 cm, 9"



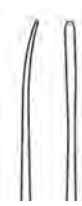
**31-682-01 T**

Häkchen  
Hook  
Gancho  
Uncino



**31-682-02 T**

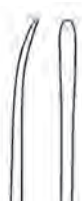
Häkchen  
Hook  
Gancho  
Uncino



1,4 mm

**31-682-03 T**

Dissektor  
Dissector  
Disecador  
Dissettore



1,8 mm

**31-682-04 T**

Dissektor  
Dissector  
Disecador  
Dissettore



2,0 mm

**31-681-05 T**

Dissektor  
Dissector  
Disecador  
Dissettore



**31-682-05 T**

Löffel  
Curette  
Cucharilla  
Curetta



**31-682-06 T**

Löffel  
Curette  
Cucharilla  
Curetta



**31-682-07 T**

Raspatorium  
Raspatory  
Legra  
Periostotomo



**31-681-04 T**

Raspatorium  
Raspatory  
Legra  
Periostotomo



**31-681-04 T - 31-682-07 T** 23,0 cm, 9"



4,5 mm

**31-684-01**

Dissektor  
Dissector  
Disecador  
Dissettore



**CASPAR**

**31-684-01** 23,0 cm, 9"



4,5 mm

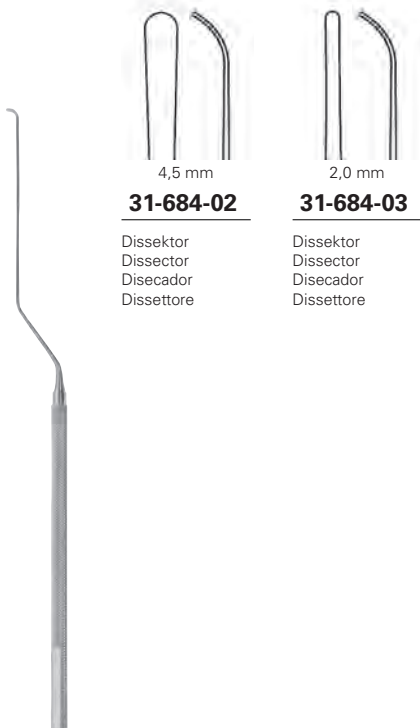
**31-684-01 T**

Dissektor  
Dissector  
Disecador  
Dissettore



**CASPAR**

**31-684-01 T** 23,0 cm, 9"

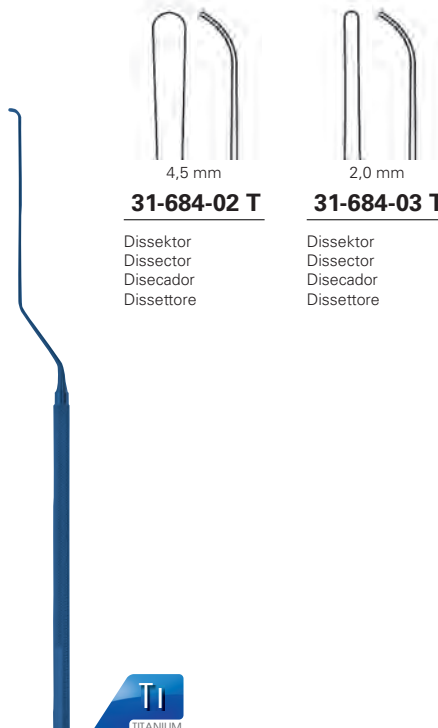


4,5 mm  
**31-684-02**  
 Dissektor  
 Dissector  
 Disecador  
 Dissettore

2,0 mm  
**31-684-03**  
 Dissektor  
 Dissector  
 Disecador  
 Dissettore

**CASPAR**

**31-684-02 - 31-684-03** 23,0 cm, 9"



4,5 mm  
**31-684-02 T**  
 Dissektor  
 Dissector  
 Disecador  
 Dissettore

2,0 mm  
**31-684-03 T**  
 Dissektor  
 Dissector  
 Disecador  
 Dissettore

**CASPAR**

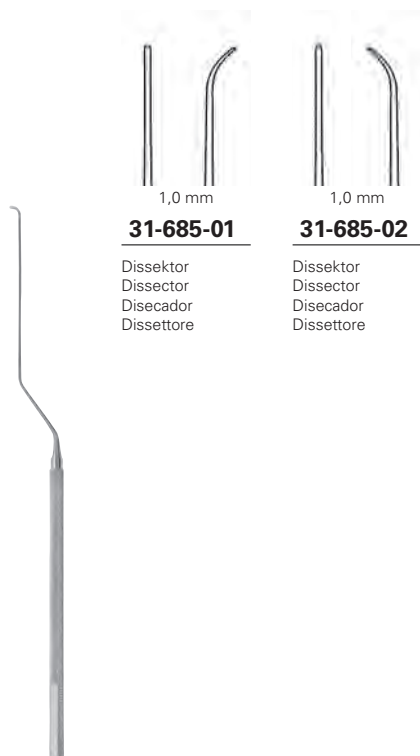
**31-684-02 T - 31-684-03 T** 23,0 cm, 9"



1,0 mm  
**31-686-01**  
 Dissektor  
 Dissector  
 Disecador  
 Dissettore

**CASPAR**

**31-686-01** 20,0 cm, 8"

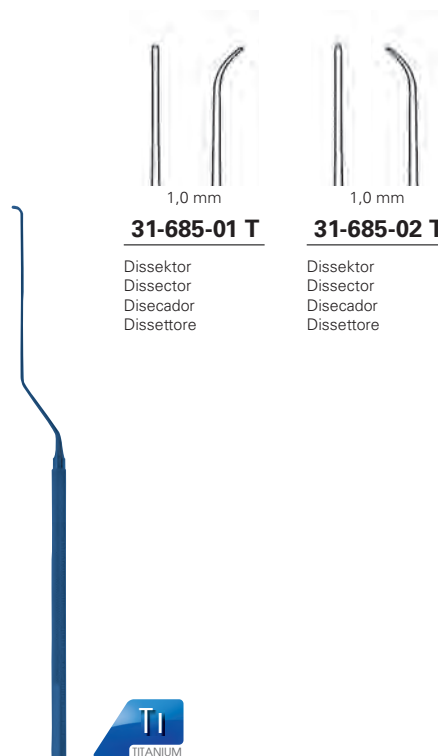


1,0 mm  
**31-685-01**  
 Dissektor  
 Dissector  
 Disecador  
 Dissettore

1,0 mm  
**31-685-02**  
 Dissektor  
 Dissector  
 Disecador  
 Dissettore

**CASPAR**

**31-685-01 - 31-685-02** 21,0 cm, 8 ¼"



1,0 mm  
**31-685-01 T**  
 Dissektor  
 Dissector  
 Disecador  
 Dissettore

1,0 mm  
**31-685-02 T**  
 Dissektor  
 Dissector  
 Disecador  
 Dissettore

**CASPAR**

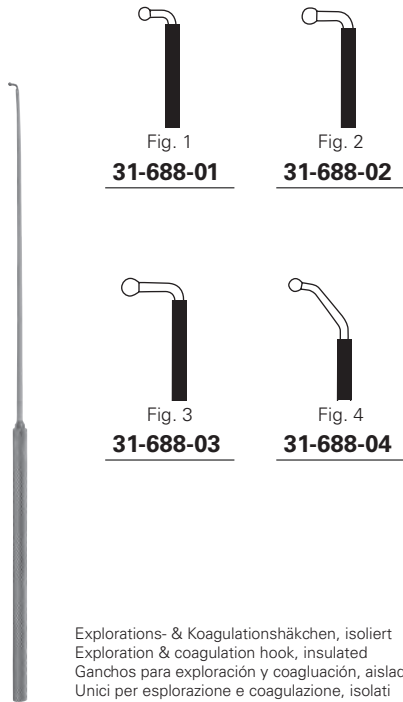
**31-685-01 T - 31-685-02 T** 21,0 cm, 8 ¼"



1,0 mm  
**31-686-01 T**  
 Dissektor  
 Dissector  
 Disecador  
 Dissettore

**CASPAR**

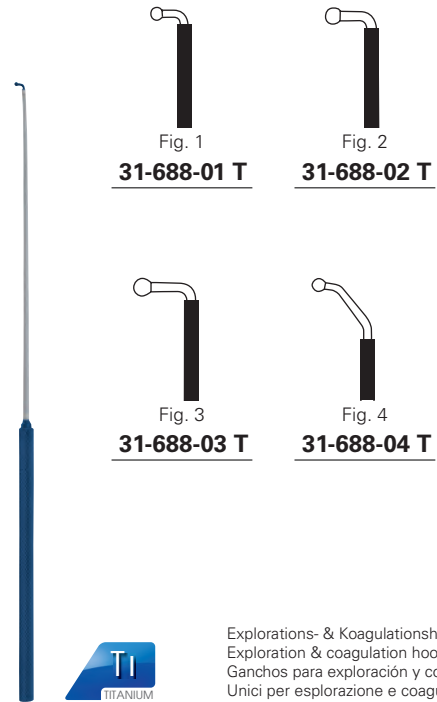
**31-686-01 T** 20,0 cm, 8"



Explorations- & Koagulationshäkchen, isoliert  
Exploration & coagulation hook, insulated  
Ganchos para exploración y coagulación, aislados  
Unici per esplorazione e coagulazione, isolati

**CASPAR**

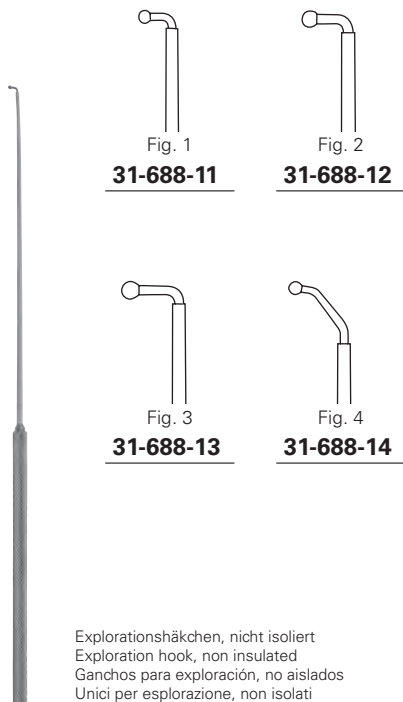
**31-688-01 - 31-688-04** 24,5 cm, 9 2/3 "



Explorations- & Koagulationshäkchen, isoliert  
Exploration & coagulation hook, insulated  
Ganchos para exploración y coagulación, aislados  
Unici per esplorazione e coagulazione, isolati

**CASPAR**

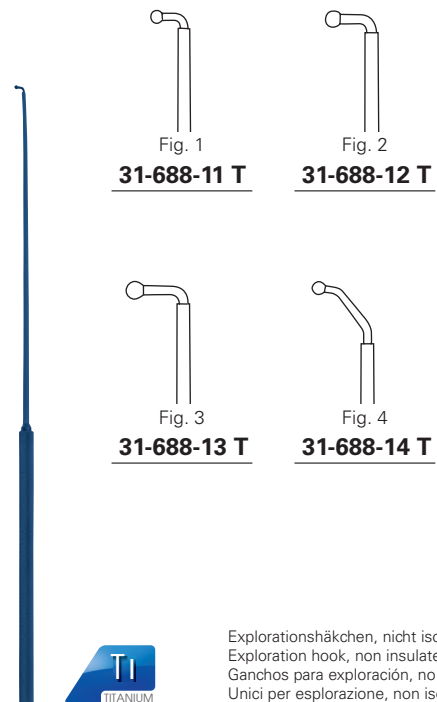
**31-688-01 T - 31-688-04 T** 24,5 cm, 9 2/3 "



Explorationshäkchen, nicht isoliert  
Exploration hook, non insulated  
Ganchos para exploración, no aislados  
Unici per esplorazione, non isolati

**CASPAR**

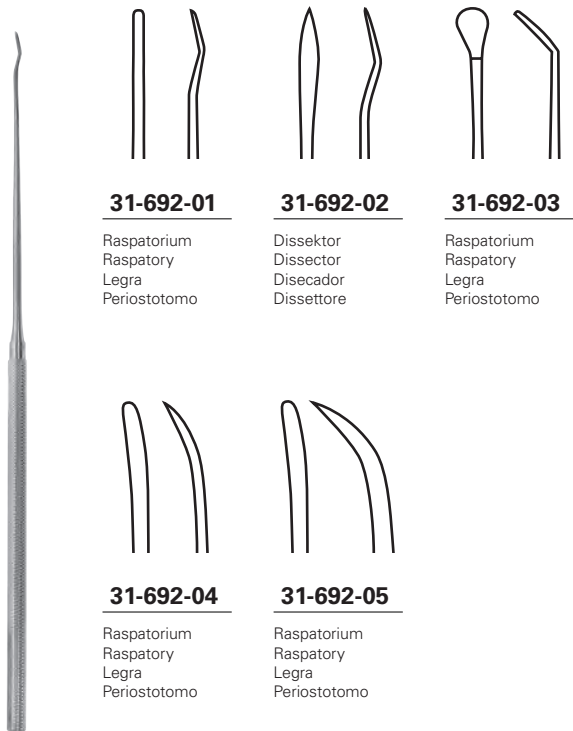
**31-688-11 - 31-688-14** 24,5 cm, 9 2/3 "



Explorationshäkchen, nicht isoliert  
Exploration hook, non insulated  
Ganchos para exploración, no aislados  
Unici per esplorazione, non isolati

**CASPAR**

**31-688-11 T - 31-688-14 T** 24,5 cm, 9 2/3 "



**31-692-01**

Raspatorium  
 Raspatory  
 Legra  
 Periostotomo

**31-692-02**

Dissektor  
 Dissector  
 Disecador  
 Dissettore

**31-692-03**

Raspatorium  
 Raspatory  
 Legra  
 Periostotomo

**31-692-01 T**

Raspatorium  
 Raspatory  
 Legra  
 Periostotomo

**31-692-02 T**

Dissektor  
 Dissector  
 Disecador  
 Dissettore

**31-692-03 T**

Raspatorium  
 Raspatory  
 Legra  
 Periostotomo

**31-692-04**

Raspatorium  
 Raspatory  
 Legra  
 Periostotomo

**31-692-05**

Raspatorium  
 Raspatory  
 Legra  
 Periostotomo

**31-692-04 T**

Raspatorium  
 Raspatory  
 Legra  
 Periostotomo

**31-692-05 T**

Raspatorium  
 Raspatory  
 Legra  
 Periostotomo

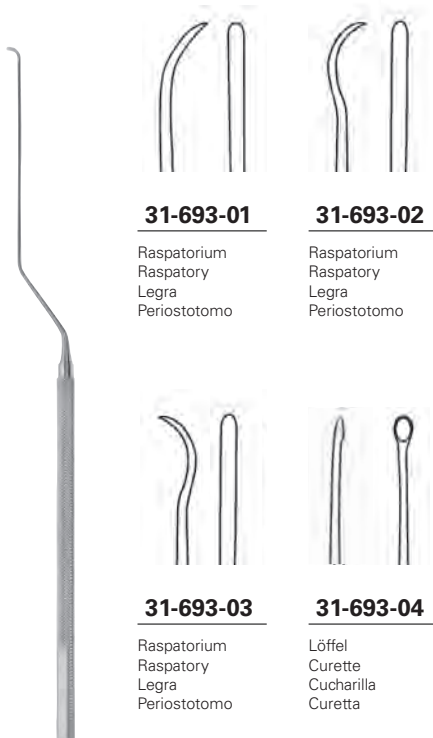
**YASARGIL**

**31-692-01 - 31-692-05** 18,5 cm, 7 ¼ "

**YASARGIL**



**31-692-01 T - 31-692-05 T** 18,5 cm, 7 ¼ "



**31-693-01**

Raspatorium  
 Raspatory  
 Legra  
 Periostotomo

**31-693-02**

Raspatorium  
 Raspatory  
 Legra  
 Periostotomo

**31-693-03**

Raspatorium  
 Raspatory  
 Legra  
 Periostotomo

**31-693-04**

Löffel  
 Curette  
 Cucharilla  
 Curetta

**31-693-01 T**

Raspatorium  
 Raspatory  
 Legra  
 Periostotomo

**31-693-02 T**

Raspatorium  
 Raspatory  
 Legra  
 Periostotomo

**31-693-03 T**

Raspatorium  
 Raspatory  
 Legra  
 Periostotomo

**YASARGIL**

**31-693-01 - 31-693-04** 18,5 cm, 7 ¼ "

**YASARGIL**



**31-693-01 T - 31-693-03 T** 18,5 cm, 7 ¼ "



1,0 mm

**31-694-10**  
**31-695-10**



1,5 mm

**31-694-15**  
**31-695-15**



2,0 mm

**31-694-20**  
**31-695-20**



2,5 mm

**31-694-25**  
**31-695-25**



3,0 mm

**31-694-30**  
**31-695-30**



3,5 mm

**31-694-35**  
**31-695-35**



4,0 mm

**31-694-40**  
**31-695-40**



5,0 mm

**31-694-50**  
**31-695-50**

Tumormesser, oval  
 Tumor knives, oval  
 Cuchillo del tumor, oval  
 Lama del tumore, ovale

**SAMII**

**31-694-10 - 31-694-50** 20,0 cm, 8 "

**31-695-10 - 31-695-50** 23,0 cm, 9 "



1,0 mm

**31-694-10 T**  
**31-695-10 T**



1,5 mm

**31-694-15 T**  
**31-695-15 T**



2,0 mm

**31-694-20 T**  
**31-695-20 T**



2,5 mm

**31-694-25 T**  
**31-695-25 T**



3,0 mm

**31-694-30 T**  
**31-695-30 T**



3,5 mm

**31-694-35 T**  
**31-695-35 T**



4,0 mm

**31-694-40 T**  
**31-695-40 T**



5,0 mm

**31-694-50 T**  
**31-695-50 T**

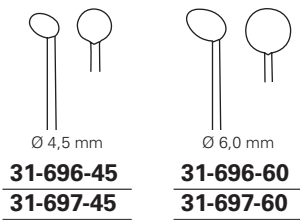
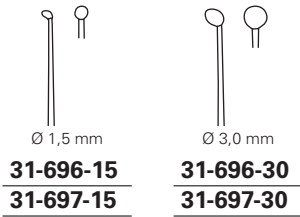
Tumormesser, oval  
 Tumor knives, oval  
 Cuchillo del tumor, oval  
 Lama del tumore, ovale

**SAMII**



**31-694-10 T - 31-694-50 T** 20,0 cm, 8 "

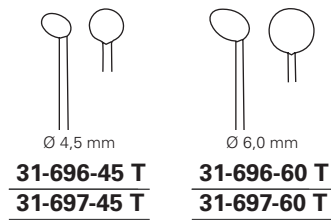
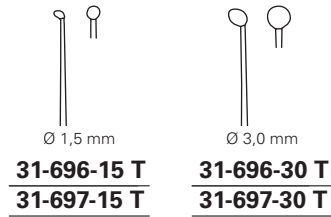
**31-695-10 T - 31-695-50 T** 23,0 cm, 9 "



Tumormesser, rund  
 Tumor knives, round  
 Cuchillo del tumor, redondo  
 Lama del tumore, redondo

**SAMII**

**31-696-15 - 31-696-60** 20,0 cm, 8 "  
**31-697-15 - 31-697-60** 23,0 cm, 9 "



Tumormesser, rund  
 Tumor knives, round  
 Cuchillo del tumor, redondo  
 Lama del tumore, redondo

**SAMII**



**31-696-15 T - 31-696-60 T** 20,0 cm, 8 "  
**31-697-15 T - 31-697-60 T** 23,0 cm, 9 "



Lanzettenmesser, oval  
 Lancet knives, oval  
 Bisturi de lanceta, oval  
 Bisturi a lancetta, ovale

**SAMII**

**31-698-18 - 31-698-25** 23,0 cm, 9 "



Lanzettenmesser, oval  
 Lancet knives, oval  
 Bisturi de lanceta, redondo  
 Bisturi a lancetta, rotondo

**SAMII**

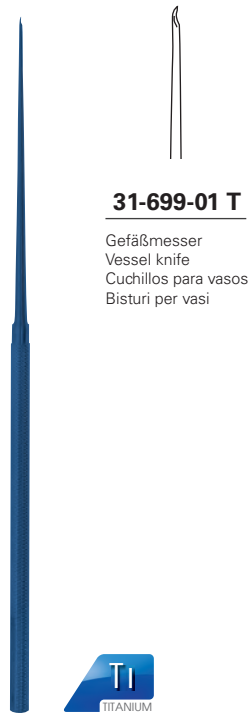


**31-698-18 T - 31-698-25 T** 23,0 cm, 9 "



**31-699-01**

Gefäßmesser  
Vessel knife  
Cuchillos para vasos  
Bisturi per vasi



**31-699-01 T**

Gefäßmesser  
Vessel knife  
Cuchillos para vasos  
Bisturi per vasi



**31-699-10**

Gefäßmesser  
Vessel knife  
Cuchillos para vasos  
Bisturi per vasi

**JACOBSON**

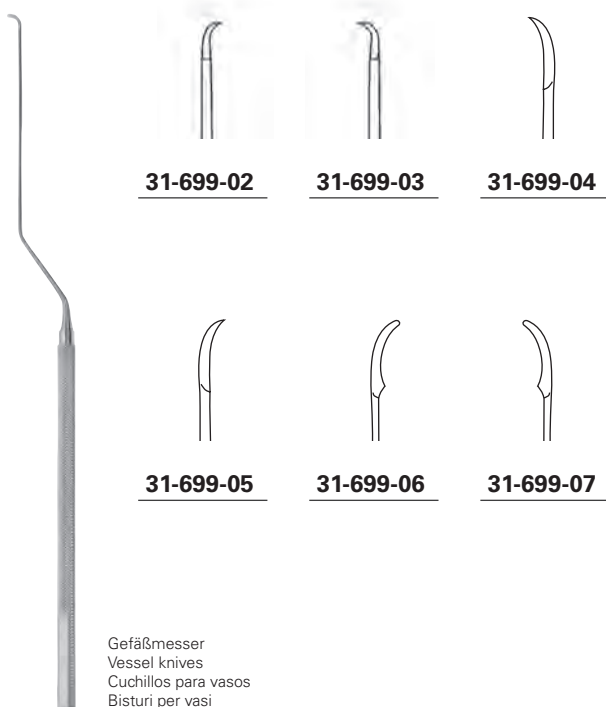
**31-699-01** 18,5 cm, 7 1/4"

**JACOBSON**

**31-699-01 T** 18,5 cm, 7 1/4"

**KRAUS**

**31-699-10** 18,5 cm, 7 1/4"



**31-699-02**

**31-699-03**

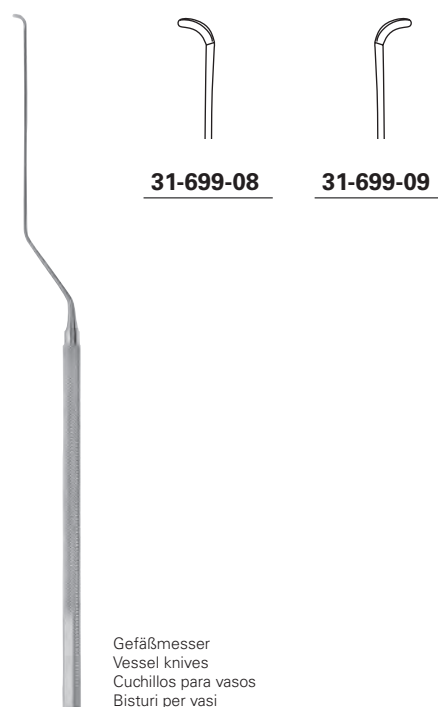
**31-699-04**

**31-699-05**

**31-699-06**

**31-699-07**

Gefäßmesser  
Vessel knives  
Cuchillos para vasos  
Bisturi per vasi



**31-699-08**

**31-699-09**

Gefäßmesser  
Vessel knives  
Cuchillos para vasos  
Bisturi per vasi

**KOOS**

**31-699-02 - 31-699-07** 18,5 cm, 7 1/4"

**YASARGIL**

**31-699-08 - 31-699-09** 18,5 cm, 7 1/4"





### **31-710-70**

Rack für 15 Rhoton Instrumente  
(Stahl oder Titan Ausführung)

Rack for 15 Rhoton instruments  
(steel or titanium model)

Rack para 15 instrumentos Rhoton  
(modelo en acero o titanio)

Supporto per 15 strumenti Rhoton  
(acciaio o metallo)

## **RHOTON**

**31-710-70** 18,5 cm, 7 ¼"



### **31-710-80**

Rack für 19 Rhoton Instrumente  
(Stahl oder Titan Ausführung)

Rack for 19 Rhoton instruments  
(steel or titanium model)

Rack para 19 instrumentos Rhoton  
(modelo en acero o titanio)

Supporto per 19 strumenti Rhoton  
(acciaio o metallo)

## **RHOTON**

**31-710-80** 18,5 cm, 7 ¼"



Fig. 1 1,0 mm  
**31-710-01**  
Dissektor  
Dissector  
Disecador  
Dissettore

Fig. 2 2,0 mm  
**31-710-02**  
Dissektor  
Dissector  
Disecador  
Dissettore

Fig. 3 3,0 mm  
**31-710-03**  
Dissektor  
Dissector  
Disecador  
Dissettore

Fig. 4 1,2 mm  
**31-710-04**  
Elevator  
Elevator  
Elevadores  
Elevatori

Fig. 5 2,8 mm  
**31-710-05**  
Elevator  
Elevator  
Elevadores  
Elevatori

Fig. 6 1,0 mm  
**31-710-06**  
Dissektor  
Dissector  
Disecador  
Dissettore

Fig. 14 1x2 mm  
**31-710-14**  
Löffel  
Curette  
Cucharilla  
Curetta

Fig. 15 5,0 mm  
**31-710-15**  
Kugeldissektor  
Teardrop dissector  
Disector esférico  
Dissettori sferici

Fig. 16 3,0 mm  
**31-710-16**  
Kugeldissektor  
Teardrop dissector  
Disector esférico  
Dissettori sferici

Fig. 17 5,0 mm  
**31-710-17**  
Kugeldissektor  
Teardrop dissector  
Disector esférico  
Dissettori sferici

Fig. 18 4,0 mm  
**31-710-18**  
Kugeldissektor  
Teardrop dissector  
Disector esférico  
Dissettori sferici

Fig. 19 8,0 mm  
**31-710-19**  
Kugeldissektor  
Teardrop dissector  
Disector esférico  
Dissettori sferici

**RHOTON**

**31-710-01 - 31-710-19** 19,0 cm, 7 1/2"



Fig. 1 1,0 mm  
**31-710-01 T**  
Dissektor  
Dissector  
Disecador  
Dissettore

Fig. 2 2,0 mm  
**31-710-02 T**  
Dissektor  
Dissector  
Disecador  
Dissettore

Fig. 3 3,0 mm  
**31-710-03 T**  
Dissektor  
Dissector  
Disecador  
Dissettore

Fig. 4 1,2 mm  
**31-710-04 T**  
Elevator  
Elevator  
Elevadores  
Elevatori

Fig. 5 2,8 mm  
**31-710-05 T**  
Elevator  
Elevator  
Elevadores  
Elevatori

Fig. 6 1,0 mm  
**31-710-06 T**  
Dissektor  
Dissector  
Disecador  
Dissettore

Fig. 14 1x2 mm  
**31-710-14 T**  
Löffel  
Curette  
Cucharilla  
Curetta

Fig. 15 5,0 mm  
**31-710-15 T**  
Kugeldissektor  
Teardrop dissector  
Disector esférico  
Dissettori sferici

Fig. 16 3,0 mm  
**31-710-16 T**  
Kugeldissektor  
Teardrop dissector  
Disector esférico  
Dissettori sferici

Fig. 17 5,0 mm  
**31-710-17 T**  
Kugeldissektor  
Teardrop dissector  
Disector esférico  
Dissettori sferici

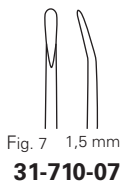
Fig. 18 4,0 mm  
**31-710-18 T**  
Kugeldissektor  
Teardrop dissector  
Disector esférico  
Dissettori sferici

Fig. 19 8,0 mm  
**31-710-19 T**  
Kugeldissektor  
Teardrop dissector  
Disector esférico  
Dissettori sferici

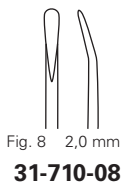


**RHOTON**

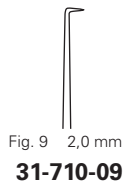
**31-710-01 T - 31-710-19 T** 19,0 cm, 7 1/2"



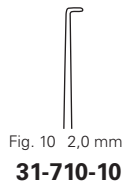
Häkchen  
 Hook  
 Gancho  
 Uncino



Häkchen  
 Hook  
 Gancho  
 Uncino



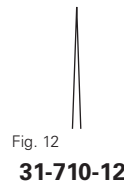
Häkchen, halbscharf  
 Hook, semi sharp  
 Gancho, semi agudo  
 Uncini, semi acuto



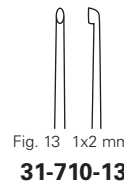
Häkchen, stumpf  
 Hook, blunt  
 Gancho, romo  
 Uncini, smusso



Häkchen, halbscharf  
 Hook, semi sharp  
 Gancho, semi agudo  
 Uncini, semi acuto



Nadel  
 Needle  
 Aguja  
 Aghi



Löffel  
 Curette  
 Cucharilla  
 Curetta



### RHOTON SET 15

**31-710-50** 19,0 cm, 7 1/2"

Bestehend aus | Consisting of | Compuesto de | Composta da

31-710-01 - 31-710-14 | 31-710-16 | 31-710-70 (Rack)

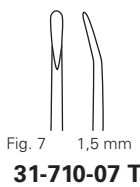


### RHOTON SET 19

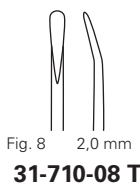
**31-710-60** 19,0 cm, 7 1/2"

Bestehend aus | Consisting of | Compuesto de | Composta da

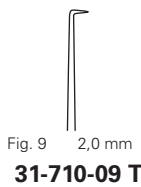
31-710-01 - 31-710-19 | 31-710-80 (Rack)



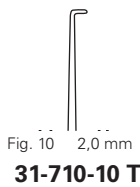
Häkchen  
 Hook  
 Gancho  
 Uncino



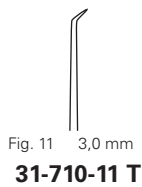
Häkchen  
 Hook  
 Gancho  
 Uncino



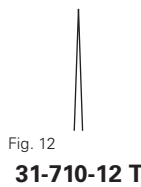
Häkchen, halbscharf  
 Hook, semi sharp  
 Gancho, semi agudo  
 Uncini, semi acuto



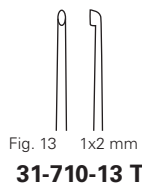
Häkchen, stumpf  
 Hook, blunt  
 Gancho, romo  
 Uncini, smusso



Häkchen, halbscharf  
 Hook, semi sharp  
 Gancho, semi agudo  
 Uncini, semi acuto



Nadel  
 Needle  
 Aguja  
 Aghi



Löffel  
 Curette  
 Cucharilla  
 Curetta



### TITAN RHOTON SET 15

**31-710-50 T** 19,0 cm, 7 1/2"

Bestehend aus | Consisting of | Compuesto de | Composta da

31-710-01 T - 31-710-14 T | 31-710-16 T | 31-710-70 (Rack)



### TITAN RHOTON SET 19

**31-710-60 T** 19,0 cm, 7 1/2"

Bestehend aus | Consisting of | Compuesto de | Composta da

31-710-01 T - 31-710-19 T | 31-710-80 (Rack)





# 33

Magen, Darm, Rektum

Stomach, Intestines, Rectum

Estómago, Intestino, Recto

Stomaco, Intestino, Retto





**33-100-15**

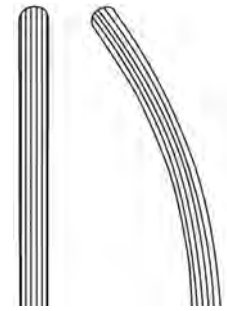
1x2 Zähne  
 1x2 teeth  
 1x2 dientes  
 1x2 denti

**33-100-20**

1x2 Zähne  
 1x2 teeth  
 1x2 dientes  
 1x2 denti

**ALLEN**

**33-100-15** 15,5 cm, 6 1/8"  
**33-100-20** 20,0 cm, 8"



**33-102-13**

**33-103-13**



**BABY-KOCHER**

**33-102-13 - 33-103-13** 13,0 cm, 5 1/8"



**33-104-13**

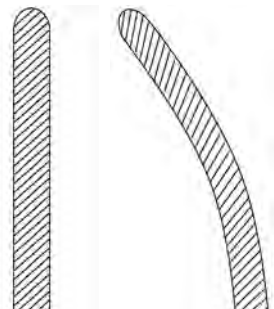


**33-105-13**



**BABY-KOCHER**

**33-104-13 - 33-105-13** 13,0 cm, 5 1/8"



**33-108-16**

**33-108-18**

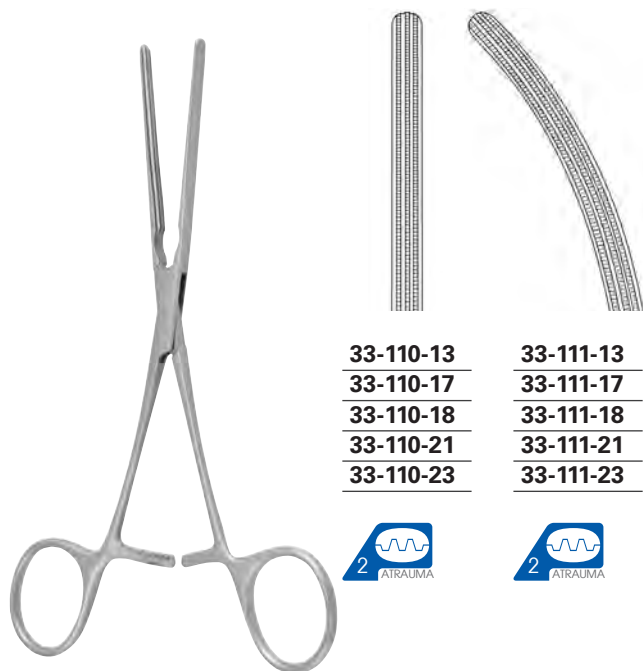
**33-109-16**

**33-109-18**



**DOYEN**

**33-108-16 - 33-109-16** 16,5 cm, 6 1/2"  
**33-108-18 - 33-109-18** 18,0 cm, 7"



**33-110-13**  
**33-110-17**  
**33-110-18**  
**33-110-21**  
**33-110-23**

**33-111-13**  
**33-111-17**  
**33-111-18**  
**33-111-21**  
**33-111-23**



Verpackungseinheit: 3 St.  
 Packing unit: 3 pieces  
 Unidad: 3 piezas  
 Confezione: 3 pezzi

**DOYEN**

<b>33-110-13 - 33-111-13</b>	14,0 cm, 5 1/2"
<b>33-110-17 - 33-111-17</b>	17,0 cm, 6 3/4"
<b>33-110-18 - 33-111-18</b>	18,5 cm, 7 1/4"
<b>33-110-21 - 33-111-21</b>	21,5 cm, 8 1/2"
<b>33-110-23 - 33-111-23</b>	23,5 cm, 9 1/4"



**DE MARTEL-WOLFSON**

<b>33-112-01</b>	50,0 mm
<b>33-112-02</b>	70,0 mm
<b>33-112-03</b>	100,0 mm



Klemmschließzange  
 Clamp closing forceps  
 Pinza para cerrar los clamps  
 Serrapinze

**DE MARTEL-WOLFSON**

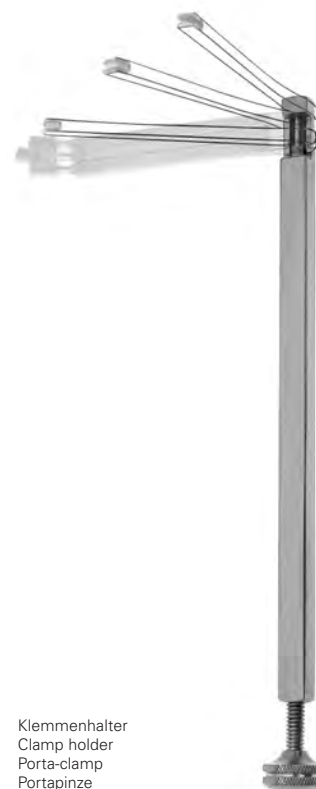
<b>33-113-00</b>	24,5 cm, 9 3/4"
------------------	-----------------



Klemmenhalter  
 Clamp holder  
 Porta-clamp  
 Portapinze

**DE MARTEL-WOLFSON**

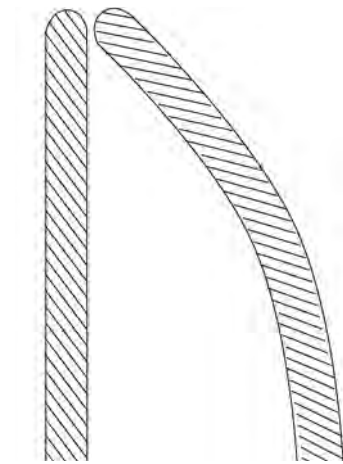
<b>33-113-08</b>	9,5 cm, 3 3/4"
------------------	----------------



Klemmenhalter  
 Clamp holder  
 Porta-clamp  
 Portapinze

**DE MARTEL-WOLFSON**

<b>33-113-23</b>	23,0 cm, 9"
------------------	-------------

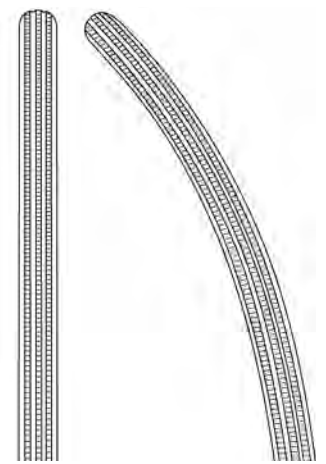


**33-114-20**

**33-115-20**

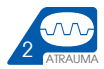
**HARTMANN**

**33-114-20 - 33-115-20** 20,0 cm, 8"



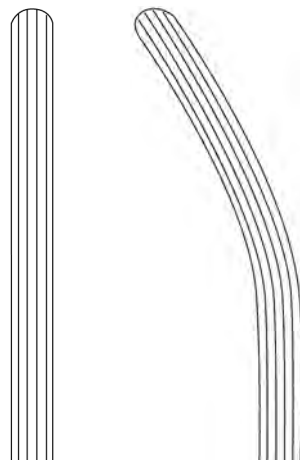
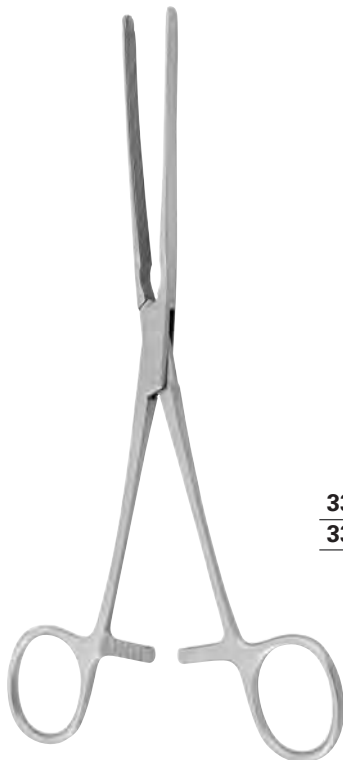
**33-116-20**

**33-117-20**



**HARTMANN**

**33-116-20 - 33-117-20** 20,0 cm, 8"

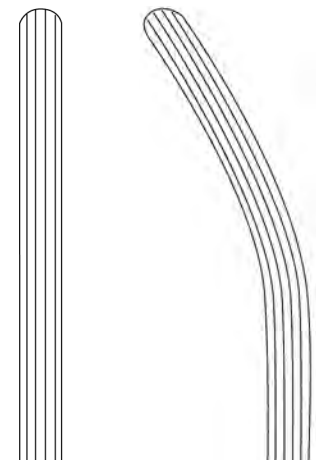


**33-120-21**  
**33-120-23**

**33-121-21**  
**33-121-23**

**KOCHER**

**33-120-21 - 33-121-21** 21,0 cm, 8 ¼"  
**33-120-23 - 33-121-23** 23,0 cm, 9"



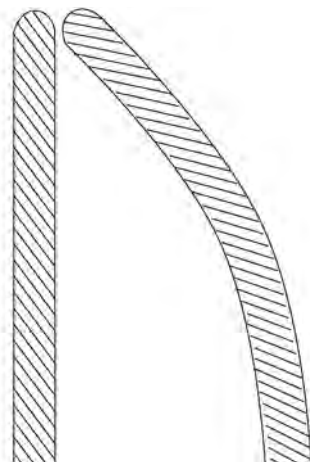
**33-124-24**

**33-125-24**

**DOYEN**

**33-124-24 - 33-125-24** 24,0 cm, 9 ½"





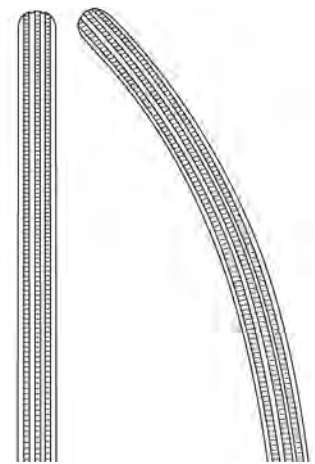
**33-126-23**

**33-127-23**



**DOYEN**

**33-126-23 - 33-127-23** 23,5 cm, 9 ¼"



**33-128-23**

**33-129-23**



**DOYEN**

**33-128-23 - 33-129-23** 23,5 cm, 9 ¼"



33-132-22  
33-132-25  
33-132-28



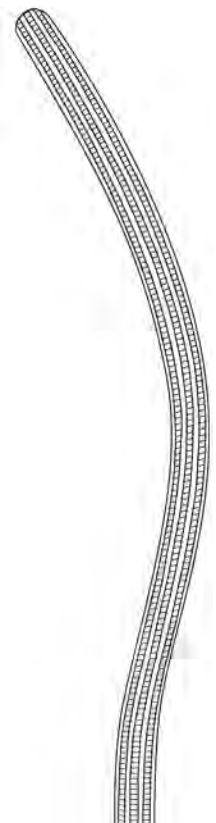
33-133-22  
33-133-25  
33-133-28

**KOCHER**

33-132-22 - 33-133-22 22,0 cm, 8 3/4"   
33-132-25 - 33-133-25 25,0 cm, 9 3/4"   
33-132-28 - 33-133-28 28,0 cm, 11"



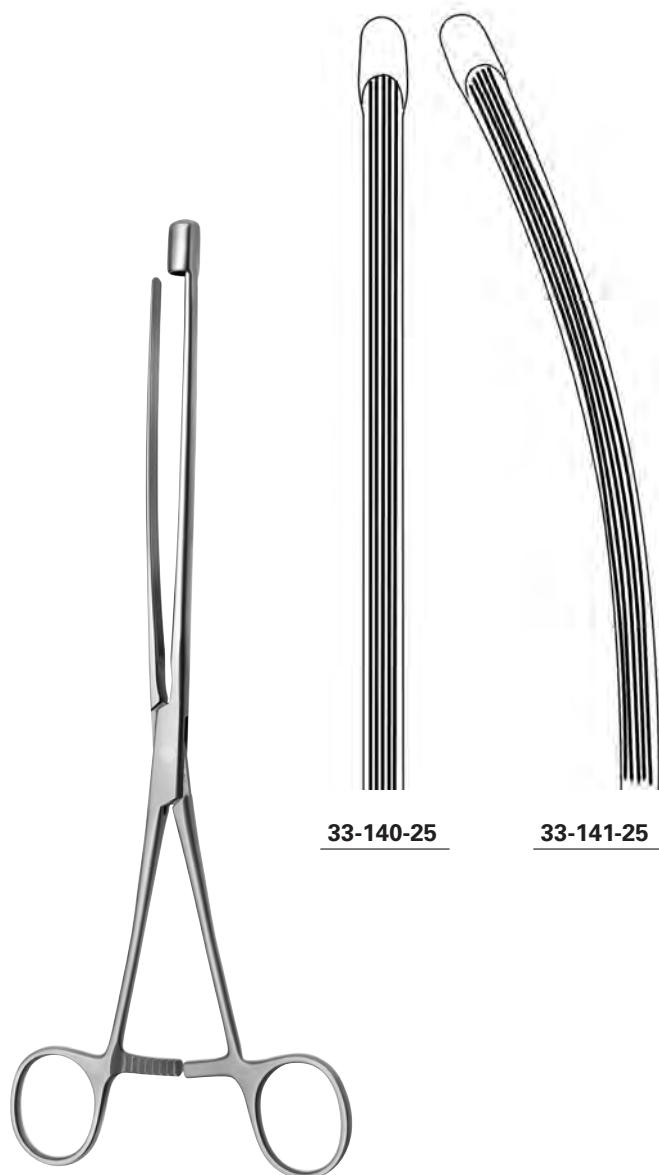
33-134-22  
33-134-25  
33-134-28



33-135-22  
33-135-25  
33-135-28

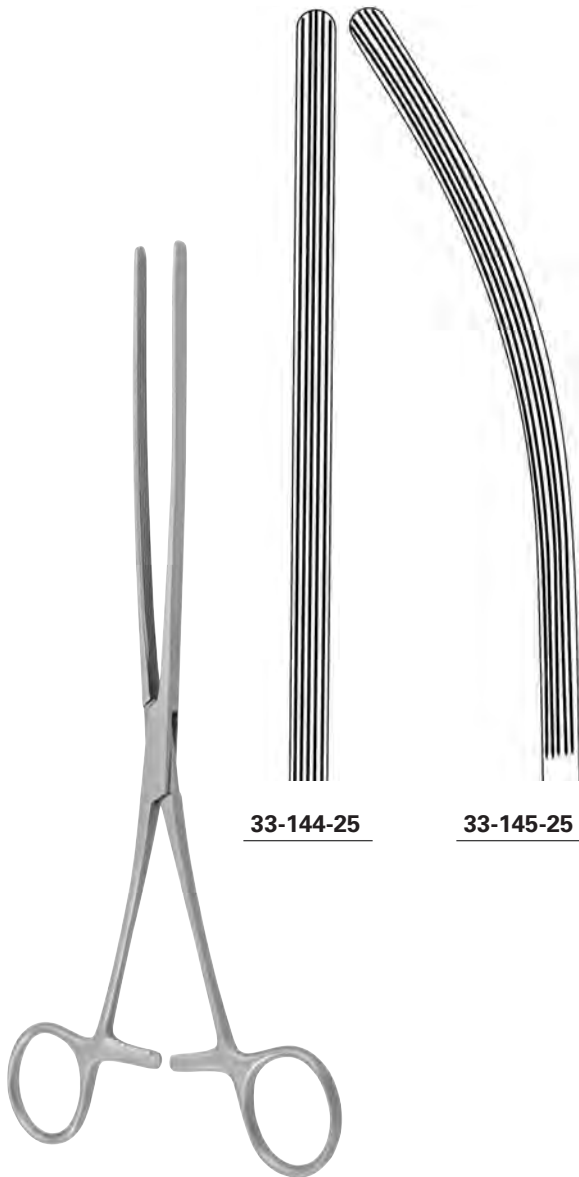
**KOCHER**

33-134-22 - 33-135-22 22,0 cm, 8 3/4"   
33-134-25 - 33-135-25 25,0 cm, 9 3/4"   
33-134-28 - 33-135-28 28,0 cm, 11"



## NUSSBAUM

33-140-25 - 33-141-25 25,0 cm, 9 <sup>3</sup>/<sub>4</sub> "

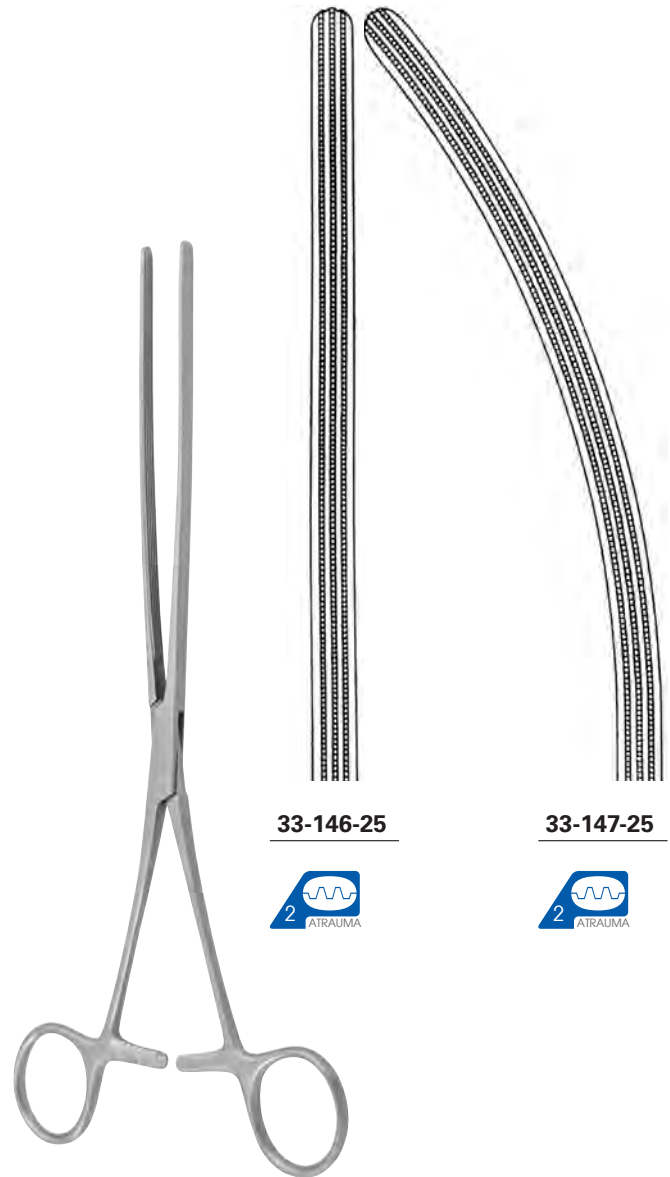


**33-144-25**

**33-145-25**

**MAYO-ROBSON**

**33-144-25 - 33-145-25** 25,0 cm, 9 3/4"

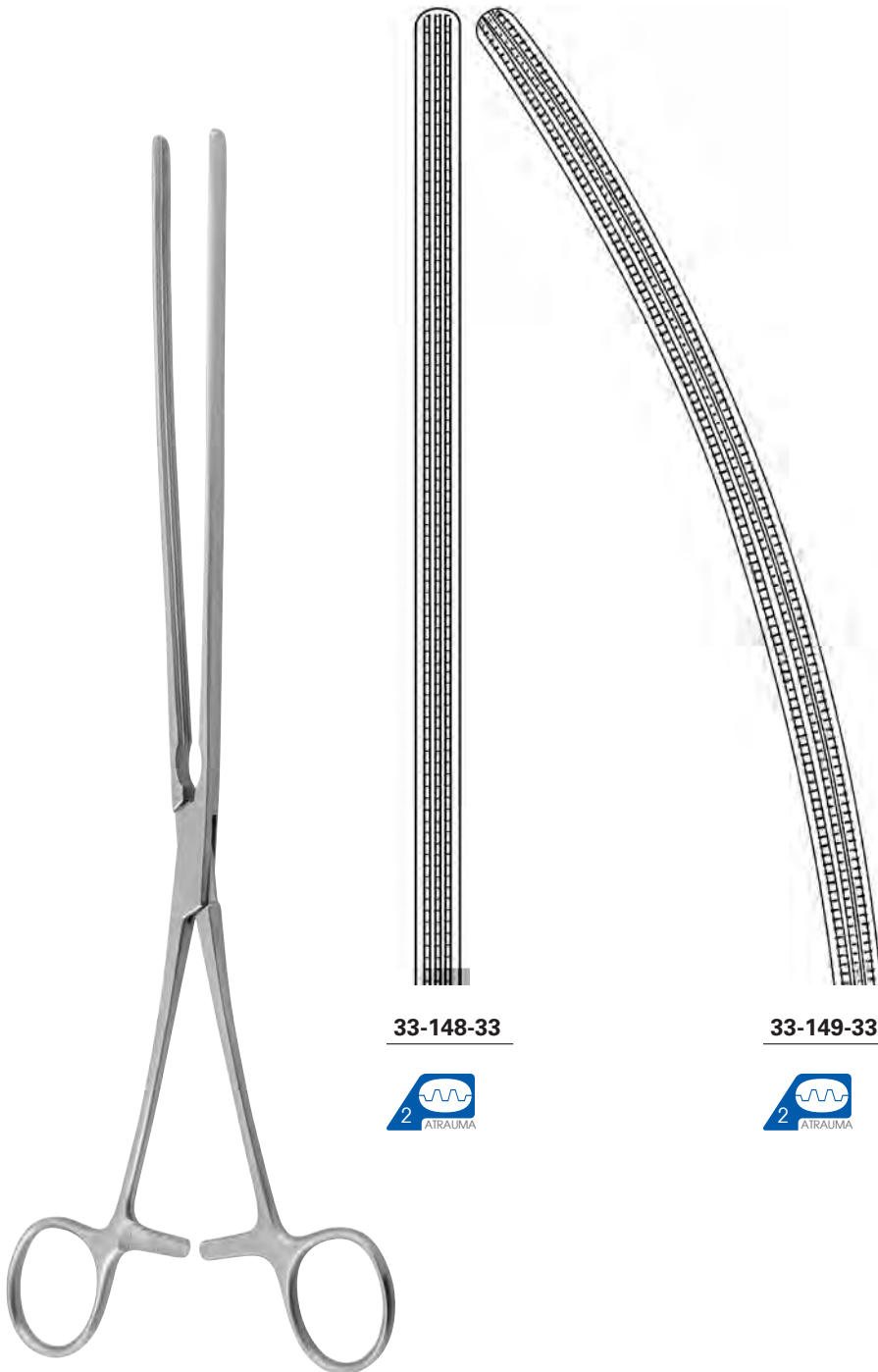


**33-146-25**

**33-147-25**

**MAYO-ROBSON**

**33-146-25 - 33-147-25** 25,0 cm, 9 3/4"



## SCUDDER

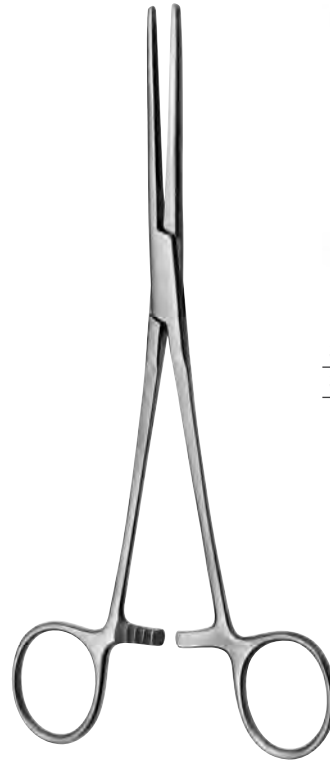
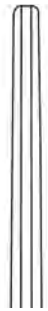
**33-148-33 - 33-149-33** 33,0 cm, 13 "



**33-150-20**  
**33-150-24**

**LANG-STEVENSON**

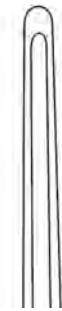
**33-150-20** 20,0 cm, 8"  
**33-150-24** 24,0 cm, 9 1/4"



**33-152-17**  
**33-152-20**

**SCHOEMAKER**

**33-152-17** 17,0 cm, 6 3/4"  
**33-152-20** 20,0 cm, 8"



**33-153-13**

1x2 Zähne  
 1x2 teeth  
 1x2 dientes  
 1x2 denti

**KLEINSCHMIDT**

**33-153-13** 13,0 cm, 5 1/8"

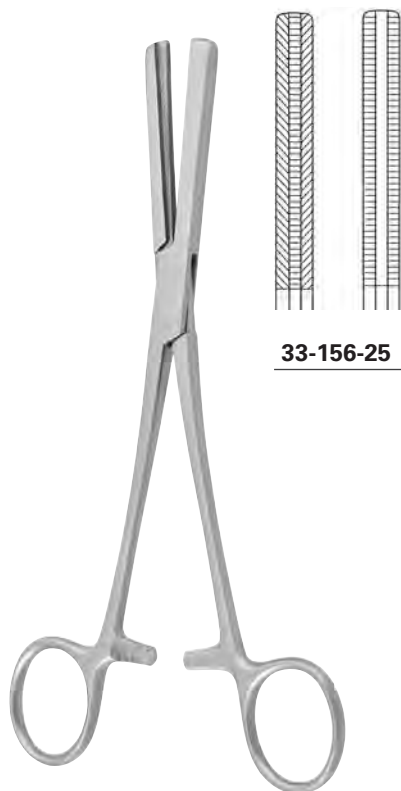


**33-153-15**

**BENSON**

**33-153-15** 15,5 cm, 6 1/8"



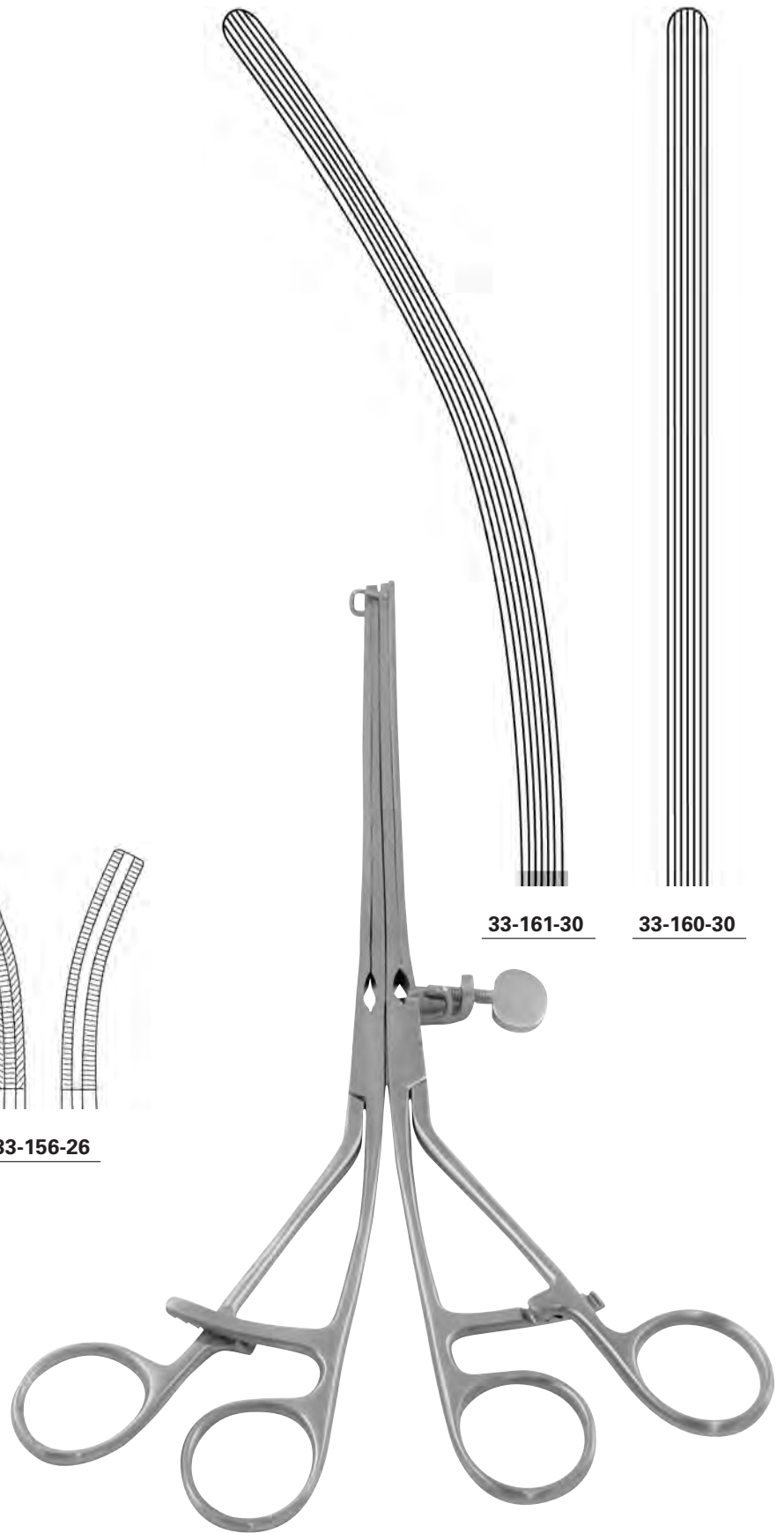


**33-156-25**

**33-156-26**

**FERGUSSON**

**33-156-25 - 33-156-26** 20,0 cm, 6 <sup>3</sup>/<sub>4</sub>"

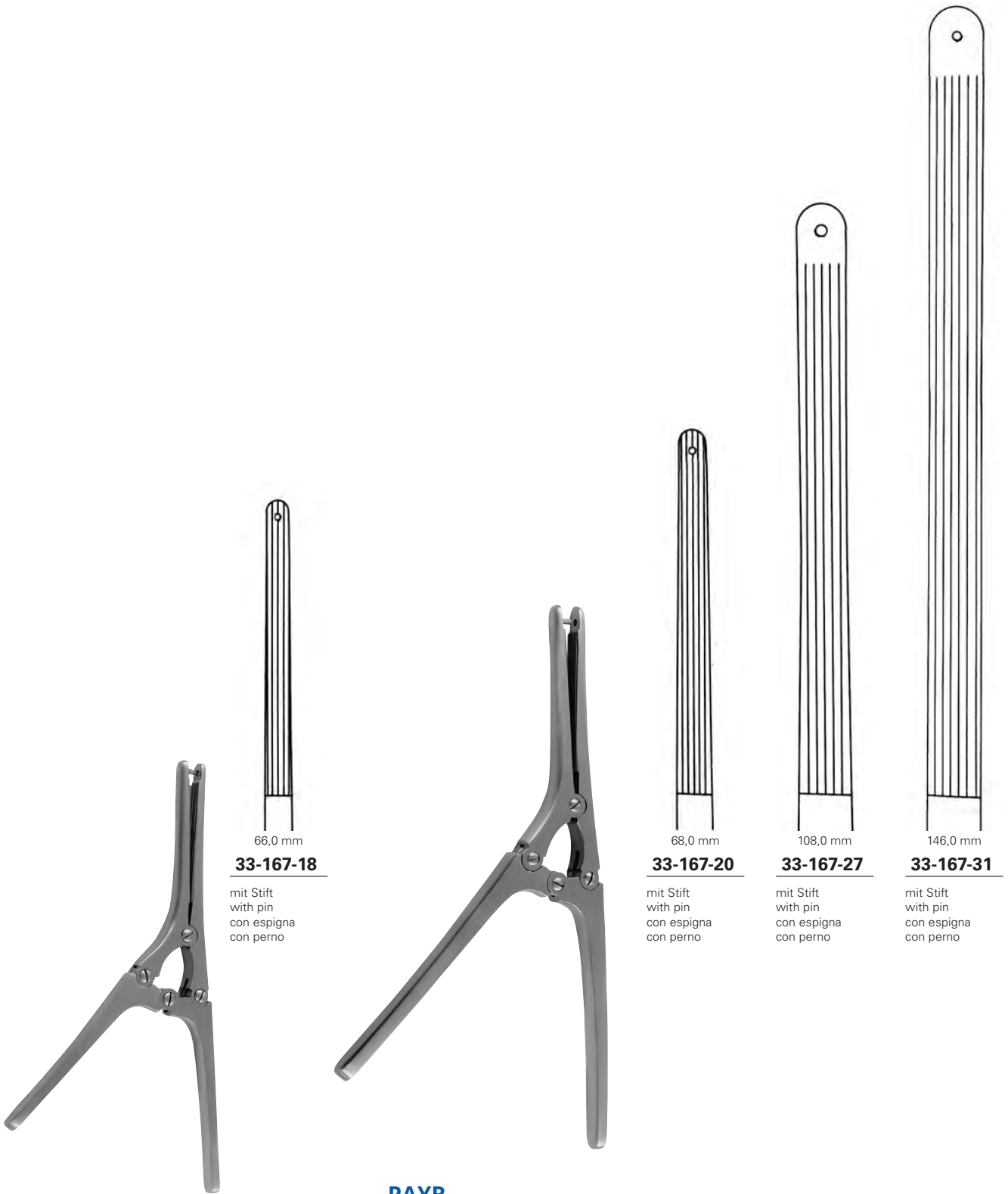


**33-161-30**

**33-160-30**

**LANE**

**33-160-30 - 33-161-30** 30,0 cm, 11 <sup>3</sup>/<sub>4</sub>"



66,0 mm

**33-167-18**

mit Stift  
 with pin  
 con espigna  
 con perno

68,0 mm

**33-167-20**

mit Stift  
 with pin  
 con espigna  
 con perno

108,0 mm

**33-167-27**

mit Stift  
 with pin  
 con espigna  
 con perno

146,0 mm

**33-167-31**

mit Stift  
 with pin  
 con espigna  
 con perno

**PAYR**

**PAYR**

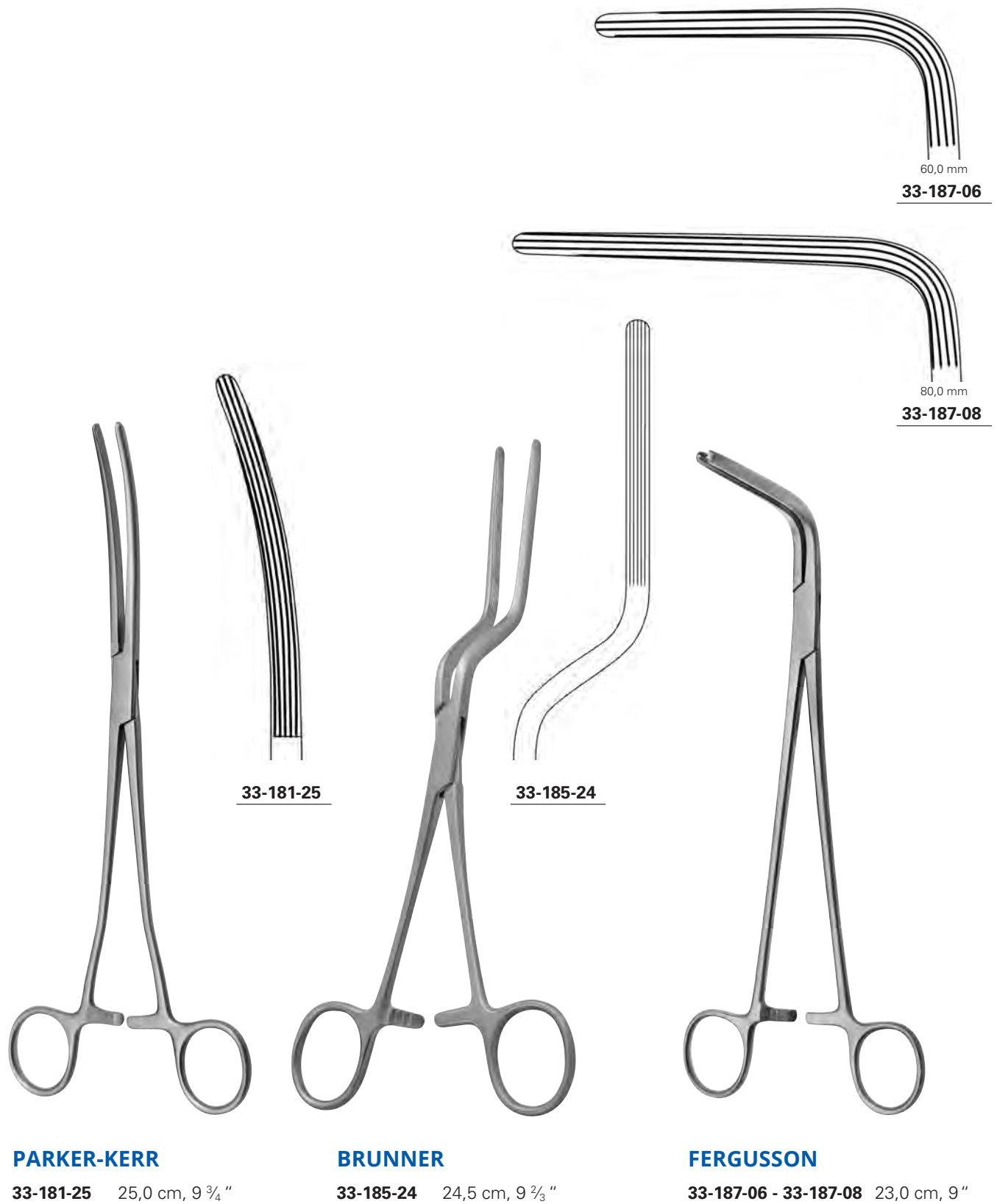
**33-167-18** 15,0 cm, 6 "

**33-167-20** 20,0 cm, 8 "

**33-167-27** 27,5 cm, 10 <sup>3</sup>/<sub>4</sub> "

**33-167-31** 31,5 cm, 12 <sup>1</sup>/<sub>2</sub> "





**PARKER-KERR**

**33-181-25** 25,0 cm, 9 3/4 "

**BRUNNER**

**33-185-24** 24,5 cm, 9 2/3 "

**FERGUSSON**

**33-187-06 - 33-187-08** 23,0 cm, 9 "

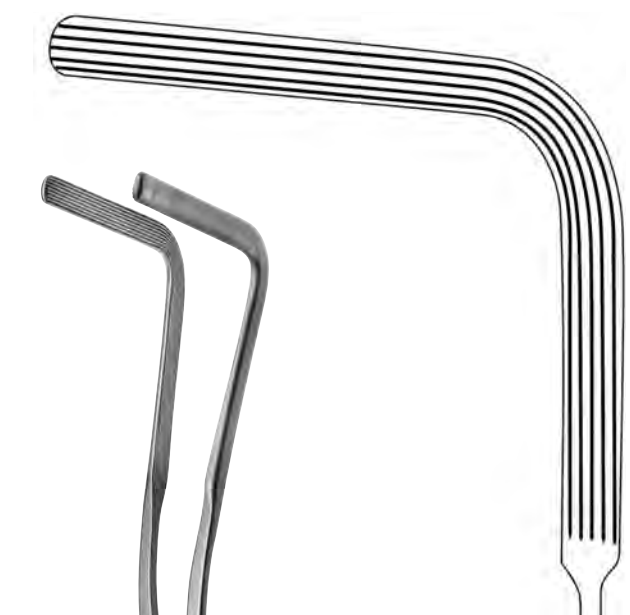


85,0 mm  
**33-187-09**



**FEHLAND**

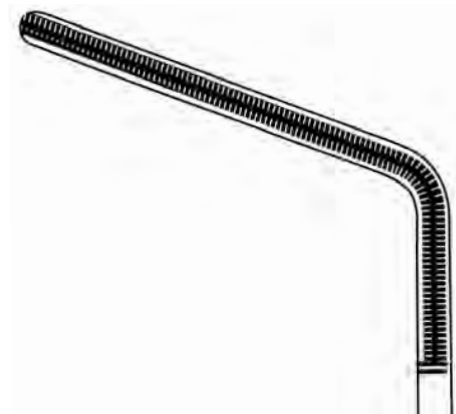
**33-187-09** 24,0 cm, 9 ½"



**33-189-31**

**LLOYD-DAVIES**

**33-189-31** 31,5 cm, 12 ½"



**33-191-26**

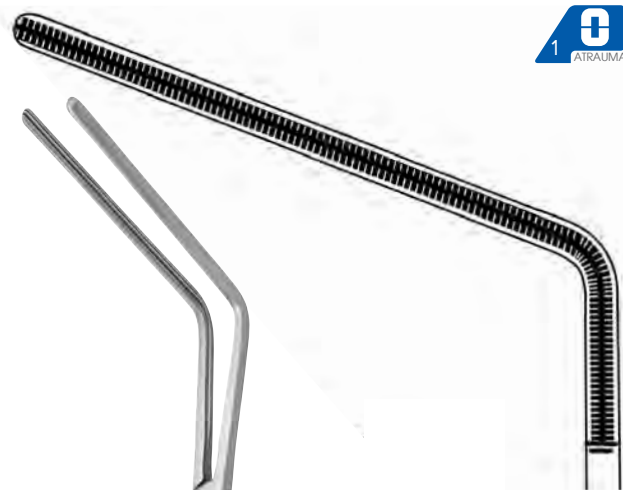


**33-191-25**



**VEIDENHEIMER**

**33-191-25** 25,0 cm, 9 3/4"



**33-191-28**



**HAYES**

**33-191-26** 27,0 cm, 10 3/4"  
**33-191-28** 28,0 cm, 11"

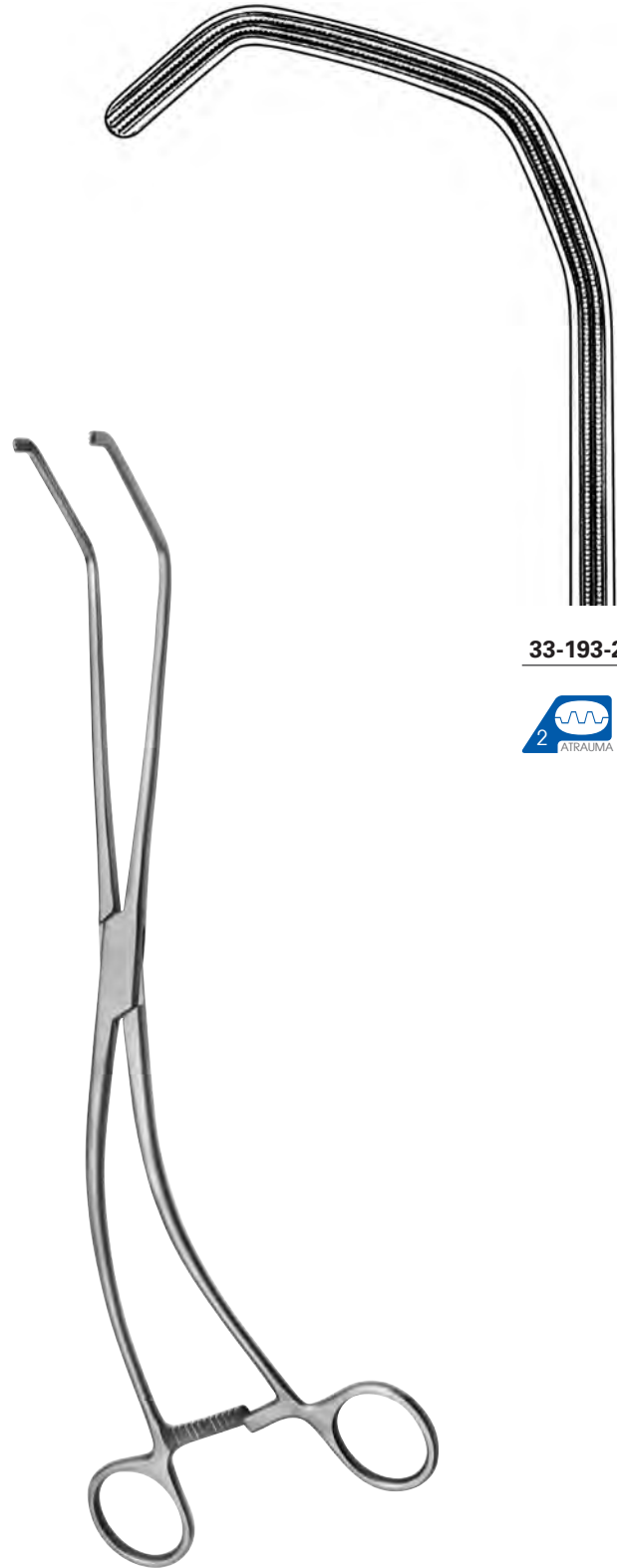


**33-192-37**



**MUELLER**

**33-192-37** 37,5 cm, 14 3/4"

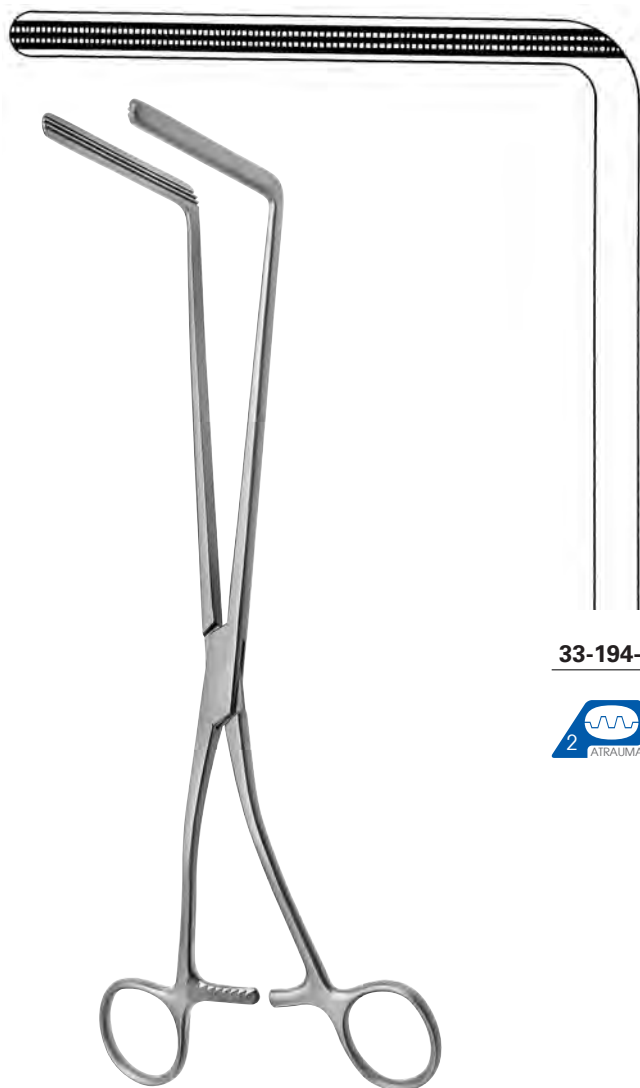


**33-193-27**



**KERSTING**

**33-193-27** 30,0 cm, 11 3/4"



33-194-26



### RESANO

33-194-26 26,5 cm, 10 1/2"



33-195-25



### WERTHEIM

33-195-25 25,0 cm, 9 3/4"



**STONE-WATT**

**33-196-07** 8,5 cm, 3 1/3"  
**33-196-10** 10,0 cm, 4"



Klemmschloß  
 Locking device  
 Cierre para clamps  
 Serratura per pinze

**STONE-WATT**

**33-196-00**

Schließklemme  
 Closing forceps  
 Pinza para cerrar clamps  
 Serrapinze e portapinze



**STONE-WATT**


**33-196-15** 15,5 cm, 6 1/8"



komplett  
 complete  
 completo  
 completo

**PETZ**

**33-200-00**

 Verpackungseinheit: 300 St.  
 Packing unit: 300 pieces  
 Unidad: 300 piezas  
 Confezione: 300 pezzi



**33-200-20**



### SIMS-BODENHAMMER

**33-300-15** 15,5 cm, 6 1/8"



### SIMS

**33-302-15** 15,5 cm, 6 1/8"



105 x 23 - 28 mm

### CZERNY

**33-305-22** 22,5 cm, 9"



80 x 25 mm

### PRATT

**33-308-20** 21,5 cm, 8 1/2"

Analspreizer  
Rectal retractor  
Separadores para el recto  
Dilatatori per l'ano ed il retto

70 x 22 mm



### BARR

**33-309-17** 17,0 cm, 6 3/4"

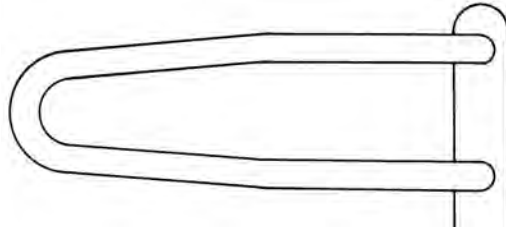


90 x 15 mm

### MATHIEU

**33-312-21** 21,0 cm, 8 1/4"





<b>33-310-19</b>	60,0 mm
<b>33-310-23</b>	80,0 mm
<b>33-310-24</b>	125,0 mm
<b>33-310-25</b>	150,0 mm

Mastdarmspekula  
 Rectal specula  
 Espéculos para el recto  
 Speculi rettali

**SIMS**

<b>33-310-19</b>	19,0 cm, 7 1/2"
<b>33-310-23</b>	23,5 cm, 9 1/4"
<b>33-310-24</b>	23,5 cm, 9 1/4"
<b>33-310-25</b>	24,5 cm, 9 2/3"



Proktoskope  
 Proctoscopes  
 Proctoscopios  
 Proctoscopi



Anuskope  
 Anusscopes  
 Anoscopios  
 Anoscopi



Anuskope  
 Anusscopes  
 Anoscopios  
 Anoscopi

**CHELSEA**

<b>33-313-22</b>	Ø 22 x 65 mm
<b>33-313-30</b>	Ø 30 x 65 mm

**BENSAUDE**

<b>33-314-20</b>	Ø 19 x 70 mm
<b>33-314-23</b>	Ø 22 x 70 mm

**FANSLER**

<b>33-315-25</b>	Ø 25 x 65 mm
<b>33-315-29</b>	Ø 29 x 65 mm
<b>33-315-35</b>	Ø 35 x 65 mm





Anuskope mit Kaltlichtaufsatz  
 Anusopes with fibre optic light carrier  
 Anoscopios para adaptador luz fria  
 Anoscopi per inserto a fibra ottica



AMNOTEC  
 KARL STORZ  
 OLYMPUS  
 ACMI  
 RICHARD WOLF



Anoskop  
 Anusopes  
 Anoscopios  
 Anoscopi



Anuskope  
 Anusopes  
 Anoscopios  
 Anoscopi

### HIRSCHMANN

<b>33-317-01</b>	Ø 16 x 65 mm
<b>33-317-02</b>	Ø 19 x 65 mm
<b>33-317-03</b>	Ø 22 x 65 mm
<b>33-317-04</b>	Ø 25 x 125 mm

### IVES-FANSLER

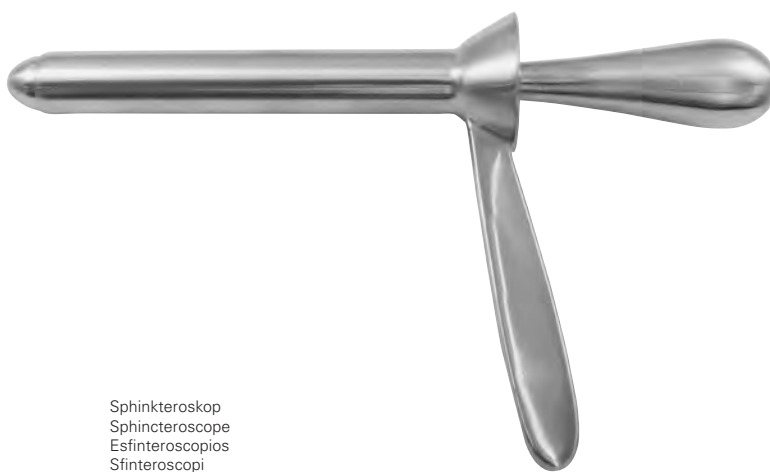
**33-316-22** Ø 22 x 85 mm

### IVES-FANSLER

**33-316-24** Ø 22 x 85 mm



Sphinkteroskope  
 Sphincteroscopes  
 Esfinteroscopios  
 Sfinteroscopi



Sphinkteroskop  
 Sphincteroscope  
 Esfinteroscopios  
 Sfinteroscopi

### KELLY

**33-318-21** Ø 21 x 50 mm  
**33-320-27** Ø 27 x 50 mm

### KELLY

**33-322-22** Ø 22 x 140 mm

Proktoskope mit Kaltlichtaufsatz  
 Proctoscopes with fibre optic light carrier  
 Proctoscopios para adaptador luz fria  
 Proctoscopi per inserto a fibra ottica



AMNOTEC  
 KARL STORZ  
 OLYMPUS  
 ACMI  
 RICHARD WOLF

Kaltlichtaufsatz  
 Fibre optic light carrier  
 Adaptador luz fria  
 Inserto a fibra ottica



AMNOTEC  
 KARL STORZ  
 OLYMPUS  
 ACMI  
 RICHARD WOLF

**MORGAN**

<b>33-324-17</b>	Ø 17 x 65 mm
<b>33-324-18</b>	Ø 17 x 80 mm
<b>33-324-20</b>	Ø 20 x 65 mm
<b>33-324-21</b>	Ø 20 x 80 mm
<b>33-324-24</b>	Ø 24 x 65 mm
<b>33-324-25</b>	Ø 24 x 80 mm

**MORGAN**

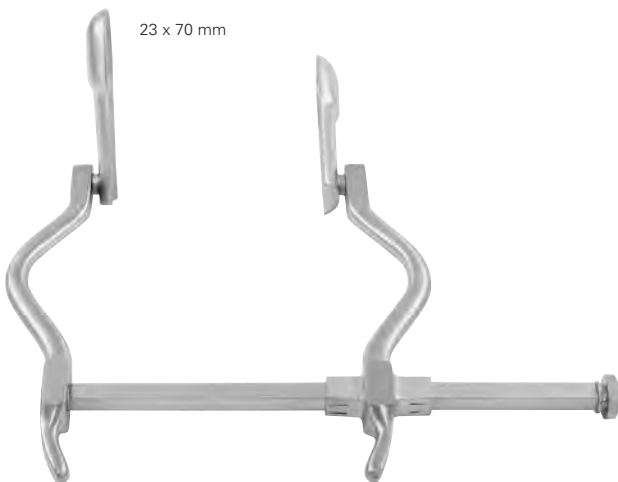
**33-324-99**



Aminoskope  
 Aminoscopes  
 Aminoscopio  
 Amnioscopio

<b>33-326-12</b>	Ø 12 x 200 mm
<b>33-326-16</b>	Ø 16 x 200 mm
<b>33-326-20</b>	Ø 20 x 200 mm

max. Spreizweite 110 mm  
 max. spread 110 mm  
 apertura máxima 110 mm  
 apertura massima 110 mm



23 x 70 mm

**SMITH-BUIE**

<b>33-329-00</b>	15,5 cm, 6 1/8"
------------------	-----------------



**ROSCHKE**

<b>33-331-00</b>	Ø 15 - 30 mm
------------------	--------------



## ALAN-PARKS

**33-330-00** SET



Analspreizer komplett,  
bestehend aus:

1 Sperrer	<b>33-330-01</b>
1 Mittelvale 95 x 22 mm	<b>33-330-02</b>
1 Seitenvlaven 75 mm	<b>33-330-03</b>
1 Seitenvlaven 95 mm	<b>33-330-04</b>

Rectal retractor complete,  
consisting of:

1 Spreader	<b>33-330-01</b>
1 Central valve 95 x 22 mm	<b>33-330-02</b>
1 Lateral valves 75 mm	<b>33-330-03</b>
1 Lateral valves 95 mm	<b>33-330-04</b>

Separador para el recto,  
completo, compuesto de:

1 Separador	<b>33-330-01</b>
1 Valva central 95 x 22 mm	<b>33-330-02</b>
1 Valvas lateral 75 mm	<b>33-330-03</b>
1 Valvas lateral 95 mm	<b>33-330-04</b>

Dilatatore rettale, completo,  
compuesto da:

1 Divaricatore	<b>33-330-01</b>
1 Valva centrale 95 x 22mm	<b>33-330-02</b>
1 Valve laterale 75 mm	<b>33-330-03</b>
1 Valve laterale 95 mm	<b>33-330-04</b>

## ALAN-PARKS

**33-330-50** SET



Analspreizer komplett,  
bestehend aus:

1 Sperrer	<b>33-330-01</b>
1 Mittelvale 95 x 22 mm	<b>33-330-02</b>
1 Seitenvlaven 75 mm	<b>33-330-03</b>
1 Seitenvlaven 95 mm	<b>33-330-04</b>
1 Kaltlichtaufsatz	

Rectal retractor complete,  
consisting of:

1 Spreader	<b>33-330-01</b>
1 Central valve 95 x 22 mm	<b>33-330-02</b>
1 Lateral valves 75 mm	<b>33-330-03</b>
1 Lateral valves 95 mm	<b>33-330-04</b>
1 Cold light adaptor	

Separador para el recto  
completo, compuesto de:

1 Separador	<b>33-330-01</b>
1 Valva central 95 x 22 mm	<b>33-330-02</b>
1 Valvas lateral 75 mm	<b>33-330-03</b>
1 Valvas lateral 95 mm	<b>33-330-04</b>
1 Portador de luz fría	

Dilatatore rettale completo,  
compuesto da:

1 Divaricatore	<b>33-330-01</b>
1 Valva centrale 95 x 22mm	<b>33-330-02</b>
1 Valve laterale 75 mm	<b>33-330-03</b>
1 Valve laterale 95 mm	<b>33-330-04</b>
1 Supporto per luce fredda	

Seitenvlaven, paar  
Lateral vales, pair  
Valvas lateral, par  
Valve laterale, paio



## ALAN-PARKS

<b>33-330-03</b>	75 x 22 mm
<b>33-330-04</b>	95 x 22 mm
<b>33-330-06</b>	90 x 22 mm



max. Spreizweite 110 mm  
 max. spread 110 mm  
 apertura máxima 110 mm  
 apertura massima 110 mm

40 x 70 mm

**ST. MARKS**

**33-332-00** 21,0 cm, 8 ¼"



biegsam  
 malleable  
 maleable  
 malleabile

**33-340-19** 19,0 cm, 7 ½"




Ø 3,0 mm

biegsam  
 malleable  
 maleable  
 malleabile

**33-342-19** 19,0 cm, 7 ½"



**33-343-24** 24,0 cm, 9 ½"

 Verpackungseinheit: 100 St.  
 Packing unit: 100 pieces  
 Unidad: 100 piezas  
 Confezione: 100 pezzi

Ligatur-Gummiringe  
 Ligature rings  
 Anillos ligatura  
 Anelli per legature



**33-350-99**

Hämorrhoidal-Ligatoren  
 Hemorrhoidal ligators  
 Ligadores para hemorroides  
 Legatore emorroidale



Ladekonus, allein  
 Loading cone, only  
 Cono de carga, solo  
 Cono per carica, solo



**33-350-98** Ø 12,0 mm



komplett mit Ladekonus 33-350-98  
 complete with loading cone 33-350-98  
 completo con cono de carga 33-350-98  
 completo con cono per carica 33-350-98

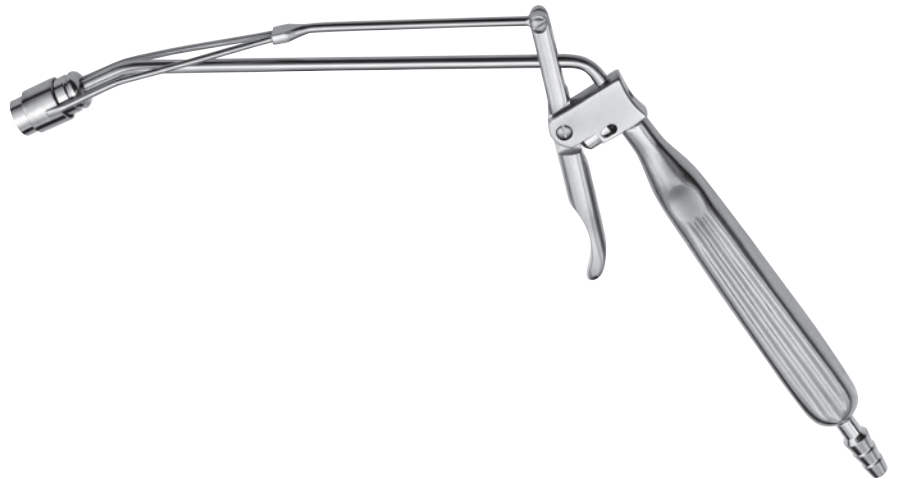
**RUDD**

**33-350-31** 31,5 cm, 12 1/2"

Saugkopf, allein  
 Suction head, only  
 cono de carga, solo  
 cono per carica, solo



**33-351-99** Ø 10,0 mm



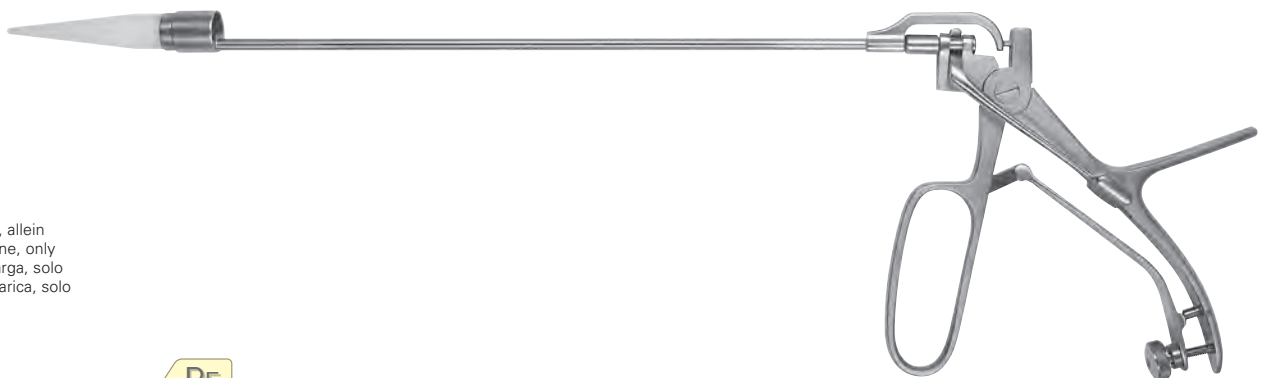
komplett mit Ladekonus und 1 Saugkopf  
 complete with loading cone and 1 suction head  
 completo con cono de carga y 1 cono de carga  
 completo con cono per carica e 1 cono per carica

**33-351-10**

Ladekonus, allein  
 Loading cone, only  
 Cono de carga, solo  
 Cono per carica, solo



**33-351-95** Ø 10,0 mm



Ladekonus, allein  
 Loading cone, only  
 Cono de carga, solo  
 Cono per carica, solo

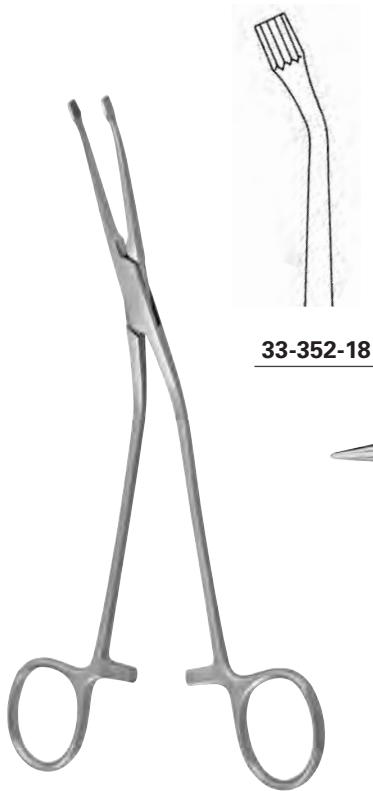


**33-352-10**

komplett mit Ladekonus 33-352-10  
 complete with loading cone 33-352-10  
 completo con cono de carga 33-352-10  
 completo con cono per carica 33-352-10

**BARRON**

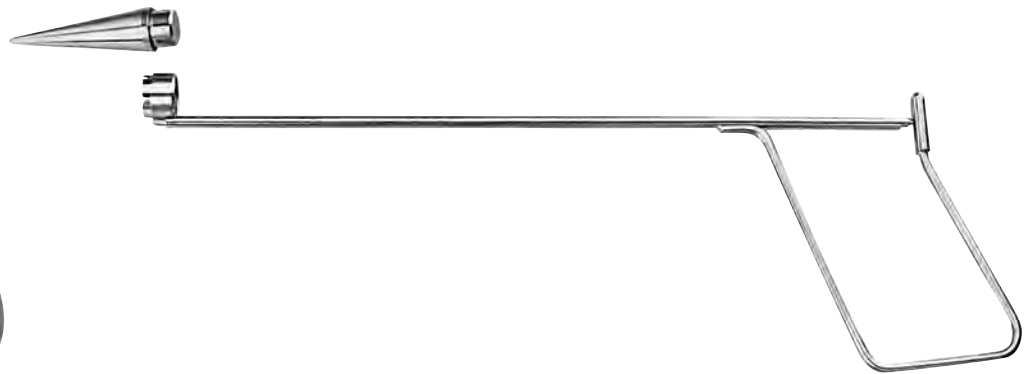
**33-352-00**



**33-352-18**

**MC GIVNEY**

**33-352-18** 18,5 cm, 7 ¼"



komplett mit Ladekonus Ø 12,0 mm  
 complete with loading cone Ø 12,0 mm  
 completo con cono de carga Ø 12,0 mm  
 completo con cono per carica Ø 12,0 mm

**MC GIVNEY**

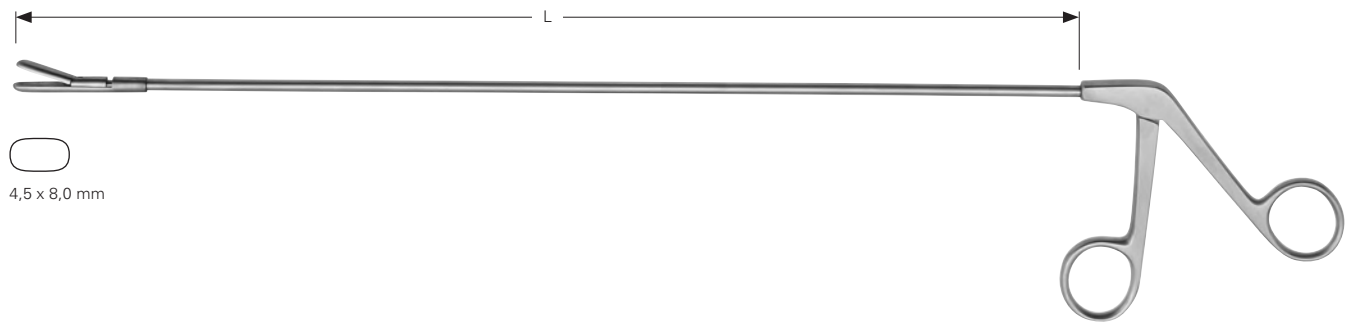
**33-353-00** 17,5 cm, 7"



komplett mit Ladekonus  
 complete with loading cone  
 completo con cono de carga  
 completo con cono per carica

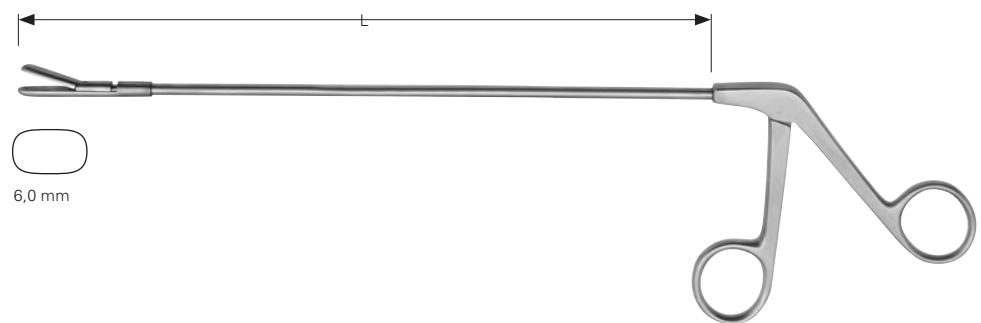
**FORD-DIXON**

**33-354-00** 25,0 cm, 9 ¾"



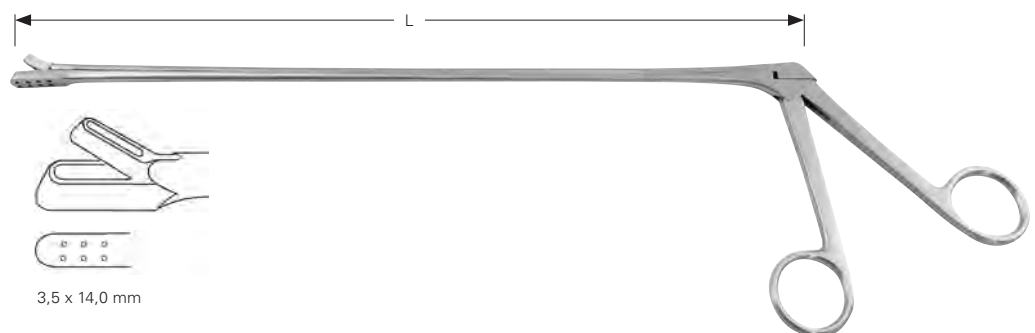
**LLOYD-DAVIS**

**33-356-35** 35,0 cm, 13<sup>3</sup>/<sub>4</sub>"



**WALTON**

**33-358-20** 20,0 cm, 8"



**YEOMANN**

**33-362-28** 28,0 cm, 11"  
**33-362-35** 35,0 cm, 13<sup>3</sup>/<sub>4</sub>"  
**33-362-42** 42,0 cm, 16<sup>1</sup>/<sub>2</sub>"





# 34

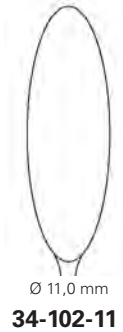
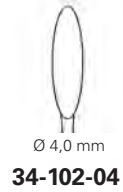
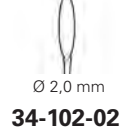
Leber, Galle, Niere

Liver, Gall bladder, Kidney

Hígado, Bilis, Riñón

Fegato, Biliari, Renali





biegsamer Schaft  
malleable shaft  
vástago maleable  
gambo malleabile

**BAKES**

**34-102-01 - 34-102-13** 31,0 cm, 12 ¼"

**BAKES**

**34-101-99** 31,0 cm, 12 ¼"

Set 34-102-03 - 34-102-11

**BAKES**

**34-102-00** 31,0 cm, 12 ¼"

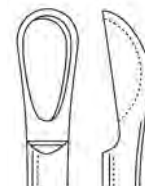
Set 34-101-01 - 34-101-13



federnd  
flexible  
flexible  
flessibile

**DESJARDINS**

**34-104-01 - 34-104-03** 28,0 cm, 11"



Ø 5,0 mm

biegsam  
malleable  
maleable  
malleabile

**MOYNIHAN**

**34-105-36** 36,0 cm, 14 ¼"



federnd  
flexible  
flexible  
flexible  
flessibile

**OCHSNER**

**34-106-35** 35,0 cm, 13 3/4"



federnd  
flexible  
flexible  
flexible  
flessibile

**DESJARDINS**

**34-118-01 - 34-118-04** 30,0 cm, 11 3/4"



6,0 mm

**34-118-01**



7,0 mm

**34-118-02**



8,0 mm

**34-118-03**



9,0 mm

**34-118-04**



biegsam  
malleable  
malleable  
malleable  
malleabile

**LUER-KOERTE**

**34-120-01 - 34-120-08** 31,0 cm, 12 1/4"



Fig. 000

**34-120-01**



Fig. 00

**34-120-02**



Fig. 0

**34-120-03**



Fig. 1

**34-120-04**



Fig. 2

**34-120-05**



Fig. 3

**34-120-06**



Fig. 4

**34-120-07**



Fig. 5

**34-120-08**



Gallenblasenlöffel  
Gall bladder scoop  
Cucharilla para la vesicula biliar  
Cucchiaio per colecisti

**MOORE**

**34-130-28** 30,0 cm, 11 3/4"



**MAYO**

**34-132-28** 28,0 cm, 11 "



**FERGUSSON**

**34-134-01 - 34-134-03** 22,0 cm, 8 ¾ "



Fig. 1

**34-134-01**



Fig. 2

**34-134-02**



Fig. 3

**34-134-03**



**MAYO**

**34-136-01 - 34-136-03** 27,0 cm, 10 ¾ "



4,0 mm

**34-136-01**



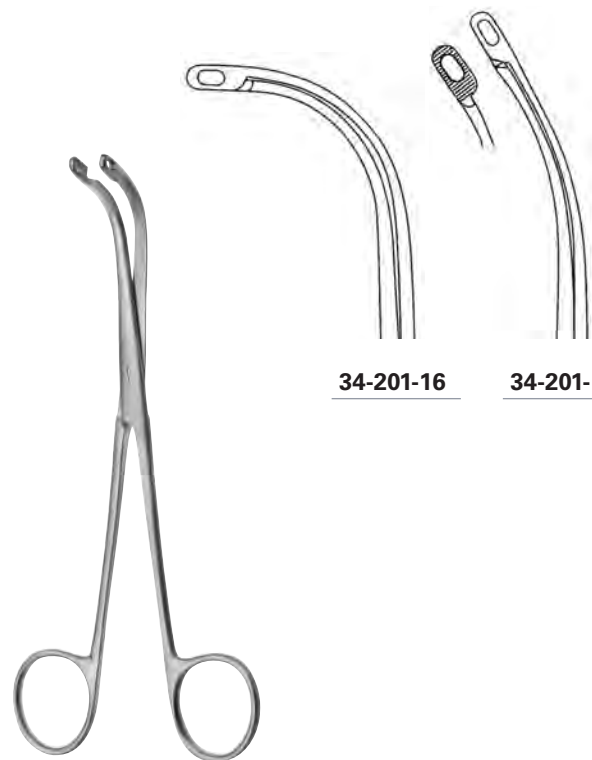
5,0 mm

**34-136-02**



6,0 mm

**34-136-03**



**HEIMING**

**34-201-16** 16,0 cm, 6 ¼ "

**34-201-17** 17,0 cm, 6 ¾ "

**34-201-16**

**34-201-17**

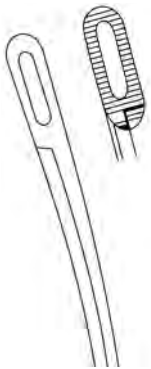


Fig. 1

**34-207-01**

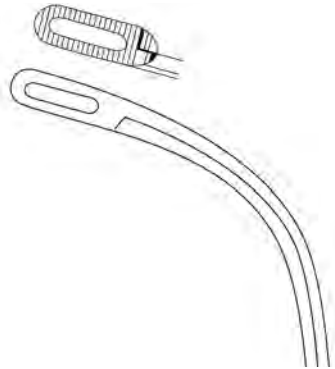


Fig. 2

**34-207-02**

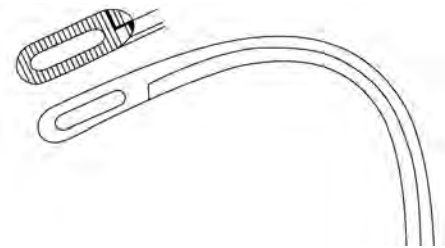


Fig. 3

**34-207-03**

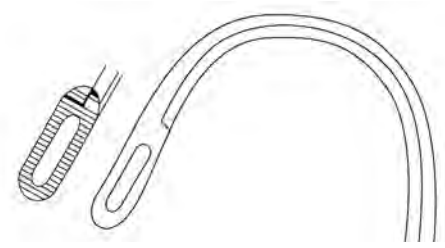


Fig. 4

**34-207-04**

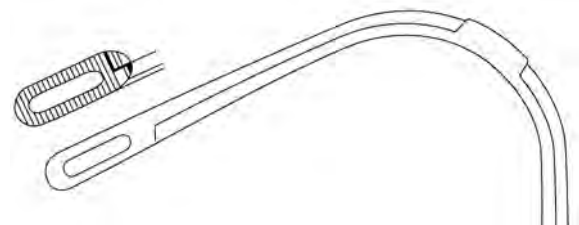


Fig. 5

**34-209-05**

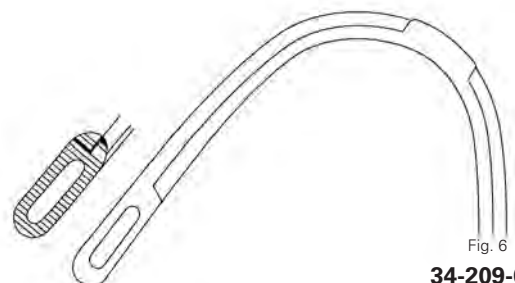


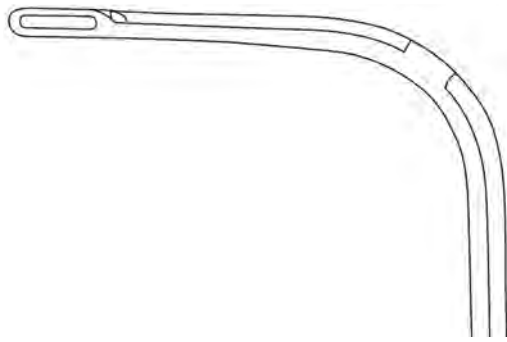
Fig. 6

**34-209-06**

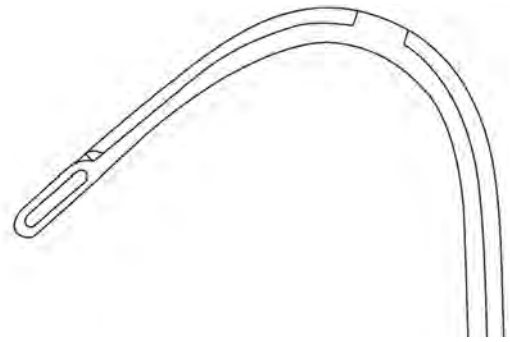


**RANDALL**

<b>34-207-01</b>	23,0 cm, 9 "
<b>34-207-02 - 34-207-04</b>	22,0 cm, 8 ¾ "
<b>34-209-05 - 34-209-06</b>	19,0 cm, 7 ½ "



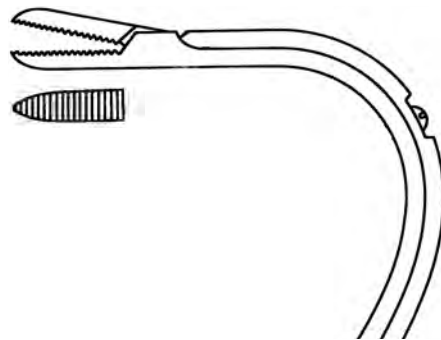
**34-211-01**



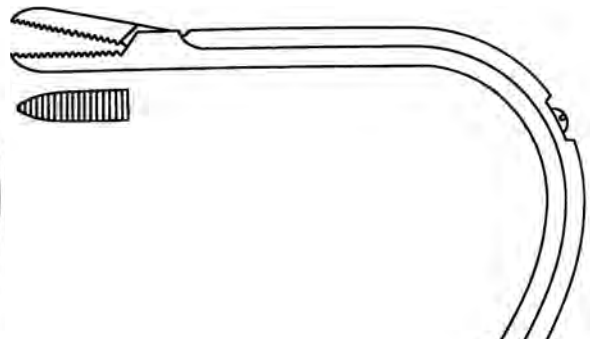
**34-211-02**

**RANDALL**

<b>34-211-01</b>	24,5 cm, 9 3/4"
<b>34-211-02</b>	23,0 cm, 9"



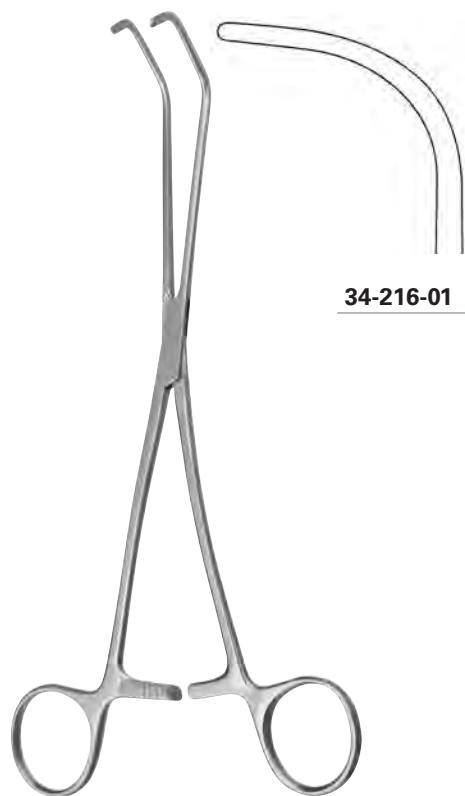
**34-215-01**



**34-215-02**

**ELSAESSER**

<b>34-215-01 - 34-215-02</b>	21,0 cm, 8 1/4"
------------------------------	-----------------



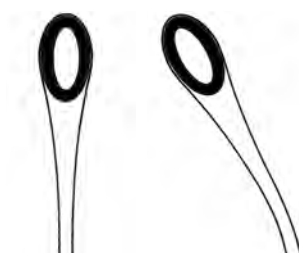
**34-216-01**



**34-216-02**

**LURZ**

**34-216-01 - 34-216-02** 21,0 cm, 8 ¼"

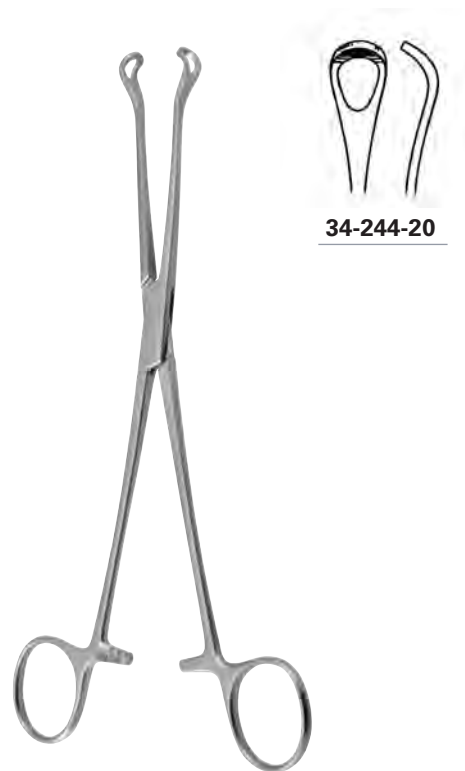


**34-240-20**

**34-241-20**

**BLAKE**

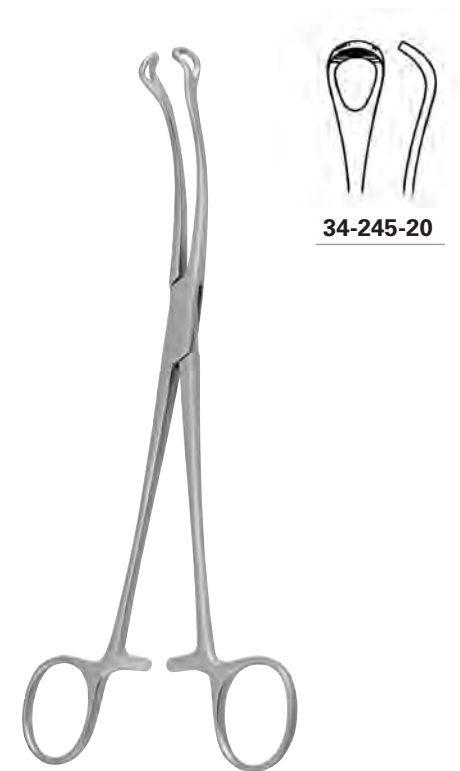
**34-240-20 - 34-241-20** 20,0 cm, 8"



**34-244-20**

**MAYO-BLAKE**

**34-244-20** 20,0 cm, 8"



**34-245-20**

**MAYO-BLAKE**

**34-245-20** 20,0 cm, 8"



**34-247-22**

**MIXTER**

**34-247-22** 22,0 cm, 8 3/4"



**34-249-01**



**34-249-02**

**DESJARDINS**

**34-249-01 - 34-249-02** 23,0 cm, 8 1/4"



**34-249-11**



**34-249-12**

sehr schlankes Modell  
 very slender pattern  
 modelo muy delgado  
 modello molto delicato

**DESJARDINS**

**34-249-11 - 34-249-12** 23,0 cm, 8 1/4"



**TUEBINGEN**

**34-251-26** 26,0 cm, 10 1/4"



**STILLE**

**34-253-24** 24,5 cm, 9 2/3"



# 35

Gynäkologie, Geburtshilfe

Gynaecology, Obstetrics

Ginecologia, Ostetricia

Ginecologia, Ostetricia



für Kinder  
for children  
para niños  
per bambini



**COLLIN**

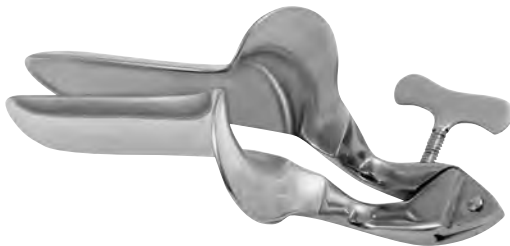
**35-000-01** 55 x 10 mm

für Jungfrauen  
for virgins  
para vírgenes  
per vergini



**COLLIN**

**35-001-01** 65 x 20 mm



**COLLIN**

**35-002-01** 85 x 30 mm

**35-002-02** 100 x 35 mm

**35-002-03** 110 x 40 mm



seitliche Stellschraube  
lateral fixation screw  
tornillo de sujeto lateral  
vite di regolazione laterale

**CUSCO**

**35-003-01** 75 x 17 mm



zentrale Stellschraube  
 central fixation screw  
 tornillo de sujeto central  
 vite di regolazione centrale

## CUSCO

**35-004-01** 75 x 17 mm



seitliche Stellschraube  
 lateral fixation screw  
 tornillo de sujeto lateral  
 vite di regolazione laterale

## CUSCO STANDARD

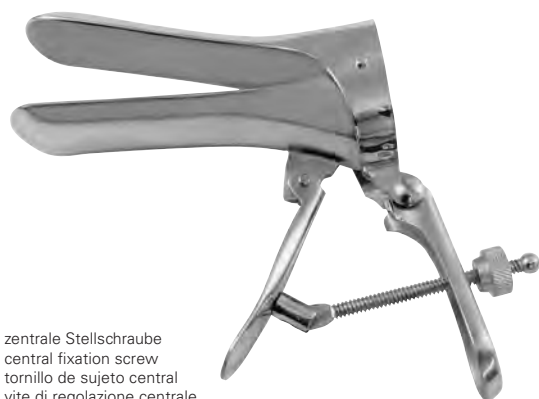
**35-005-00** 80 x 24 mm

**35-005-01** 75 x 32 mm

**35-005-02** 85 x 35 mm

**35-005-03** 110 x 37 mm

Schweizer Modell  
 Swiss pattern  
 Modelo suizo  
 Modello svizzero



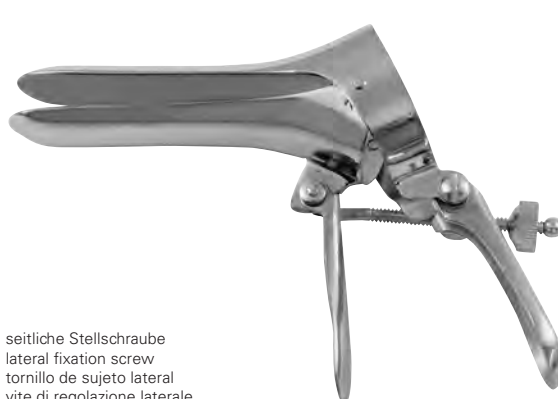
zentrale Stellschraube  
 central fixation screw  
 tornillo de sujeto central  
 vite di regolazione centrale

## CUSCO

**35-006-01** 75 x 32 mm

**35-006-02** 85 x 35 mm

**35-006-03** 100 x 37 mm



seitliche Stellschraube  
 lateral fixation screw  
 tornillo de sujeto lateral  
 vite di regolazione laterale

## CUSCO

**35-007-01** 80 x 22 mm

**35-007-02** 100 x 25 mm

**35-007-03** 105 x 27 mm



seitliche Stellschraube  
lateral fixation screw  
tornillo de sujeto lateral  
vite di regolazione laterale

**CUSCO**

<b>35-007-11</b>	80 x 32 mm
<b>35-007-12</b>	90 x 37 mm
<b>35-007-13</b>	115 x 37 mm



**SEMM**

<b>35-008-01</b>	90x14 18 mm
<b>35-008-02</b>	100x17 20 mm
<b>35-008-03</b>	100x25 30 mm



**SEYFFERT**

<b>35-009-01</b>	100 x 17 mm
<b>35-009-02</b>	110 x 33 mm



**TRELAT**

<b>35-010-01</b>	85 x 33 mm
<b>35-010-02</b>	95 x 35 mm
<b>35-010-03</b>	115 x 43 mm



### NOTT

<b>35-011-01</b>	90 x 30 mm
<b>35-011-02</b>	110 x 30 mm



seitliche Stellschraube  
 lateral fixation screw  
 tornillo de sujeto lateral  
 vite di regolazione laterale

### GRAVE

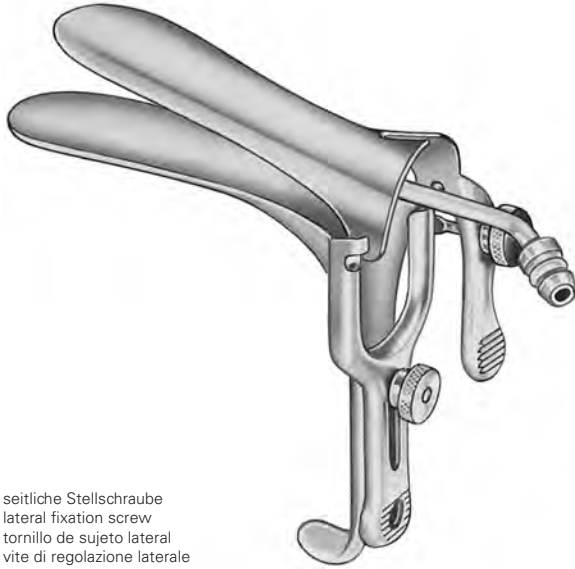
<b>35-013-01</b>	75 x 20 mm
<b>35-013-02</b>	95 x 35 mm
<b>35-013-03</b>	115 x 35 mm



seitliche Stellschraube  
 lateral fixation screw  
 tornillo de sujeto lateral  
 vite di regolazione laterale

### PEDERSON

<b>35-014-01</b>	75 x 13 mm
<b>35-014-02</b>	100 x 22 mm
<b>35-014-03</b>	120 x 25 mm



seitliche Stellschraube  
lateral fixation screw  
tornillo de sujeto lateral  
vite di regolazione laterale

**GRAVE**

**35-017-01 - 35-017-23**

Absaugung am oberen Blatt  
Suction tube on upper blade  
Tubo de succión a la valva superior  
Canula d'aspirazione alla valva superiore



seitliche Stellschraube  
lateral fixation screw  
tornillo de sujeto lateral  
vite di regolazione laterale

**GRAVE**

**35-017-01 B** 76 x 19 mm  
**35-017-02 B** 101 x 35 mm  
**35-017-03 B** 120 x 35 mm

Absaugung am oberen Blatt, isoliert  
Suction tube on upper blade, insulated  
Tubo de succión a la valva superior, aislado  
Canula d'aspirazione alla valva superiore, isolato



seitliche Stellschraube  
lateral fixation screw  
tornillo de sujeto lateral  
vite di regolazione laterale

**GRAVE**

**35-017-01 BL** 76 x 19 mm  
**35-017-02 BL** 101 x 35 mm  
**35-017-03 BL** 120 x 35 mm

**GRAVE**

**35-017-01** 76 x 19 mm  
**35-017-02** 101 x 35 mm  
**35-017-03** 120 x 35 mm

Absaugung am oberen Blatt  
Suction tube on upper blade  
Tubo de succión a la valva superior  
Canula d'aspirazione alla valva superiore

**GRAVE**

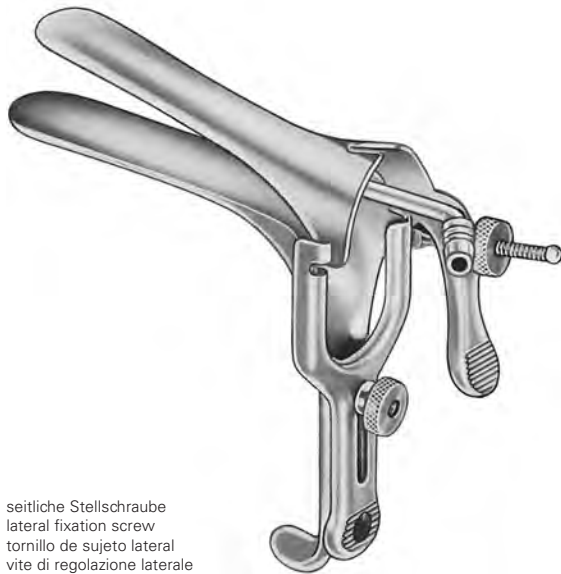
**35-017-11** 76 x 19 mm  
**35-017-12** 101 x 35 mm  
**35-017-13** 120 x 35 mm

Absaugung am unteren Blatt  
Suction tube on lower blade  
Tubo de succión a la valva inferior  
Canula d'aspirazione alla valva inferiore

**GRAVE**

**35-017-21** 76 x 19 mm  
**35-017-22** 101 x 35 mm  
**35-017-23** 120 x 35 mm

Absaugung am oberen und unteren Blatt  
Suction tube on upper and lower blade  
Tubo de succión a la valva superior y inferior  
Canula d'aspirazione alla valva superiore e inferiore



seitliche Stellschraube  
lateral fixation screw  
tornillo de sujeto lateral  
vite di regolazione laterale

## PEDERSON

<b>35-017-51</b>	76 x 13 mm
<b>35-017-52</b>	101 x 22 mm
<b>35-017-53</b>	120 x 25 mm

Absaugung am oberen Blatt  
Suction tube on upper blade  
Tubo de succión a la valva superior  
Canula d'aspirazione alla valva superiore

## PEDERSON

<b>35-017-61</b>	76 x 13 mm
<b>35-017-62</b>	101 x 22 mm
<b>35-017-63</b>	120 x 25 mm

Absaugung am unteren Blatt  
Suction tube on lower blade  
Tubo de succión a la valva inferior  
Canula d'aspirazione alla valva inferiore

## PEDERSON

<b>35-017-71</b>	76 x 13 mm
<b>35-017-72</b>	101 x 22 mm
<b>35-017-73</b>	120 x 25 mm

Absaugung am oberen und unteren Blatt  
Suction tube on upper and lower blade  
Tubo de succión a la valva superior y inferior  
Canula d'aspirazione alla valva superiore e inferiore

## PEDERSON

**35-017-51 - 35-017-73**

Absaugung am oberen Blatt  
Suction tube on upper blade  
Tubo de succión a la valva superior  
Canula d'aspirazione alla valva superiore



seitliche Stellschraube  
lateral fixation screw  
tornillo de sujeto lateral  
vite di regolazione laterale



Absaugung am oberen Blatt, isoliert  
Suction tube on upper blade, insulated  
Tubo de succión a la valva superior, aislado  
Canula d'aspirazione alla valva superiore, isolato



seitliche Stellschraube  
lateral fixation screw  
tornillo de sujeto lateral  
vite di regolazione laterale

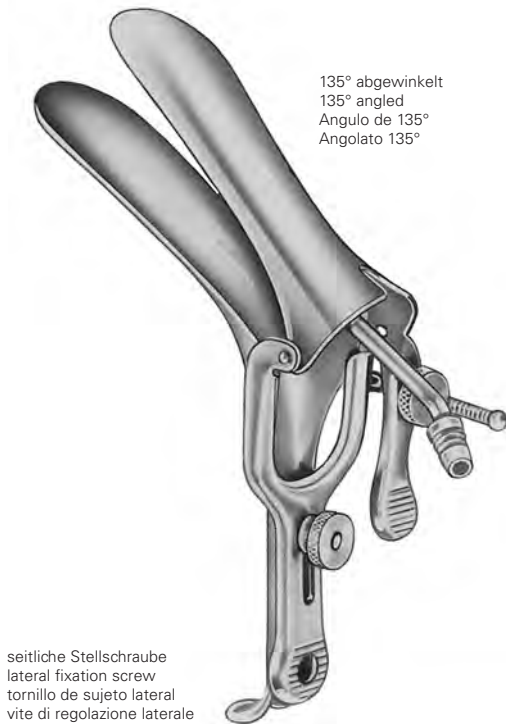
## PEDERSON

<b>35-017-51 B</b>	76 x 13 mm
<b>35-017-52 B</b>	101 x 22 mm
<b>35-017-53 B</b>	120 x 25 mm

## PEDERSON

<b>35-017-51 BL</b>	76 x 13 mm
<b>35-017-52 BL</b>	101 x 22 mm
<b>35-017-53 BL</b>	120 x 25 mm





135° abgewinkelt  
135° angled  
Angulo de 135°  
Angolato 135°

seitliche Stellschraube  
lateral fixation screw  
tornillo de sujeto lateral  
vite di regolazione laterale

### GRAVE SPECIAL

**35-018-01 - 35-018-03**

### GRAVE SPECIAL

**35-018-01** 101 x 35 mm

Absaugung am oberen Blatt  
Suction tube on upper blade  
Tubo de succión a la valva superior  
Canula d'aspirazione alla valva superiore

### GRAVE SPECIAL

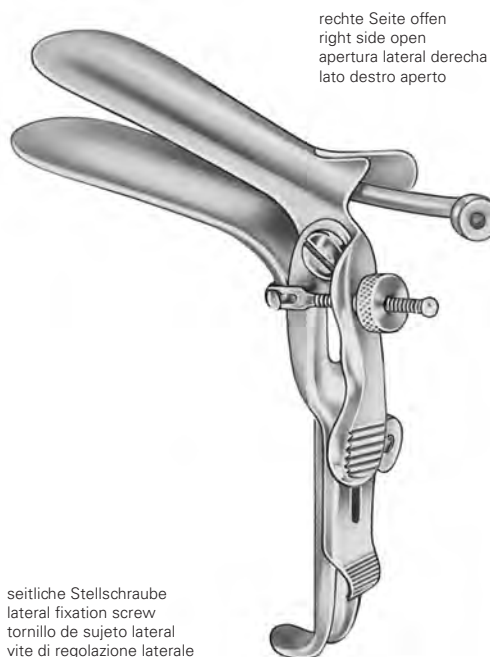
**35-018-02** 101 x 35 mm

Absaugung am unteren Blatt  
Suction tube on lower blade  
Tubo de succión a la valva inferior  
Canula d'aspirazione alla valva inferiore

### GRAVE SPECIAL

**35-018-03** 101 x 35 mm

Absaugung am oberen und unteren Blatt  
Suction tube on upper and lower blade  
Tubo de succión a la valva superior y inferior  
Canula d'aspirazione alla valva superiore e inferiore



rechte Seite offen  
right side open  
apertura lateral derecha  
lato destro aperto

seitliche Stellschraube  
lateral fixation screw  
tornillo de sujeto lateral  
vite di regolazione laterale

### GRAVE SPECIAL

**35-018-11 - 35-018-13**

### GRAVE SPECIAL

**35-018-11** 101 x 35 mm

Absaugung am oberen Blatt  
Suction tube on upper blade  
Tubo de succión a la valva superior  
Canula d'aspirazione alla valva superiore

### GRAVE SPECIAL

**35-018-12** 101 x 35 mm

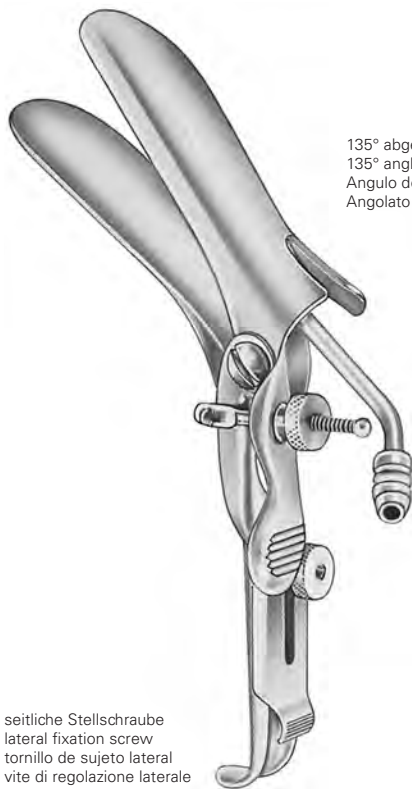
Absaugung am unteren Blatt  
Suction tube on lower blade  
Tubo de succión a la valva inferior  
Canula d'aspirazione alla valva inferiore

### GRAVE SPECIAL

**35-018-13** 101 x 35 mm

Absaugung am oberen und unteren Blatt  
Suction tube on upper and lower blade  
Tubo de succión a la valva superior y inferior  
Canula d'aspirazione alla valva superiore e inferiore





135° abgewinkelt, rechte Seite offen  
135° angled, right side open  
Angulo de 135°, apertura lateral derecha  
Angolato 135°, lato destro aperto

seitliche Stellschraube  
lateral fixation screw  
tornillo de sujeto lateral  
vite di regolazione laterale

## GRAVE SPECIAL

**35-018-21 - 35-018-23**

## GRAVE SPECIAL

**35-018-21** 101 x 35 mm

Absaugung am oberen Blatt  
Suction tube on upper blade  
Tubo de succión a la valva superior  
Canula d'aspirazione alla valva superiore

## GRAVE SPECIAL

**35-018-22** 101 x 35 mm

Absaugung am unteren Blatt  
Suction tube on lower blade  
Tubo de succión a la valva inferior  
Canula d'aspirazione alla valva inferiore

## GRAVE SPECIAL

**35-018-23** 101 x 35 mm

Absaugung am oberen und unteren Blatt  
Suction tube on upper and lower blade  
Tubo de succión a la valva superior y inferior  
Canula d'aspirazione alla valva superiore e inferiore



## SIMS

**35-019-01** 70x30 | 65x25

**35-019-02** 70x35 | 70x30

**35-019-03** 90x40 | 85x35



Spekulum und Halter  
Speculum and retractor  
Espéculo y valva  
Speculo e valva

## SEIDL

**35-020-01** 80 x 8 mm

**35-020-02** 80 x 10 mm

**35-020-03** 90 x 14 mm



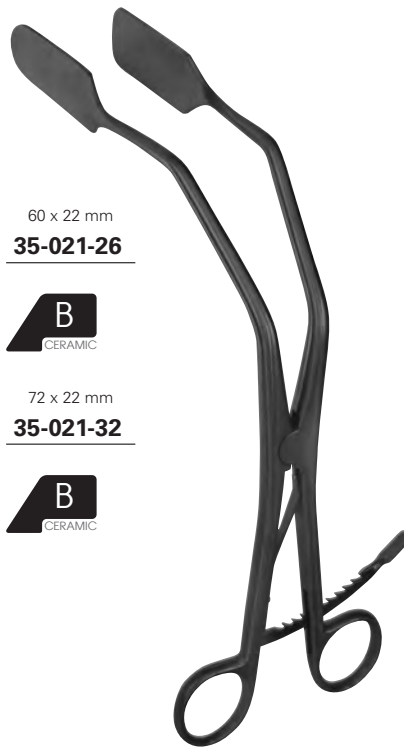
60 x 22 mm  
**35-021-25**



72 x 22 mm  
**35-021-31**



**35-021-25** 25,0 cm, 9 3/4"  
**35-021-31** 31,0 cm, 12 1/4"



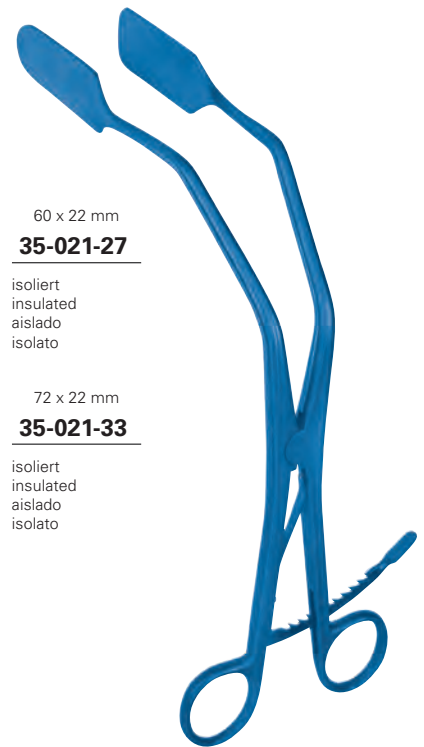
60 x 22 mm  
**35-021-26**



72 x 22 mm  
**35-021-32**



**35-021-26** 25,0 cm, 9 3/4"  
**35-021-32** 31,0 cm, 12 1/4"



60 x 22 mm  
**35-021-27**

isoliert  
insulated  
aislado  
isolato

72 x 22 mm  
**35-021-33**

isoliert  
insulated  
aislado  
isolato

**35-021-27** 25,0 cm, 9 3/4"  
**35-021-33** 31,0 cm, 12 1/4"



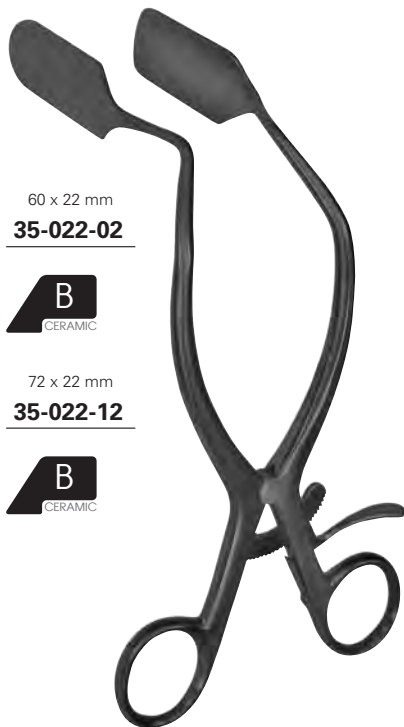
60 x 22 mm  
**35-022-01**



72 x 22 mm  
**35-022-11**



**35-022-01** 25,0 cm, 9 3/4"  
**35-022-11** 31,0 cm, 12 1/4"



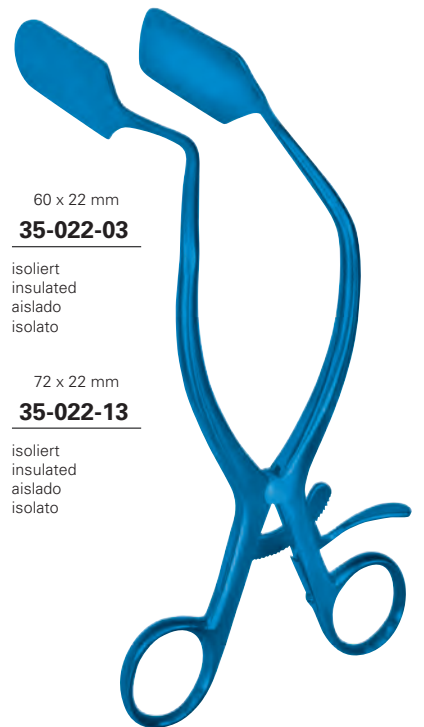
60 x 22 mm  
**35-022-02**



72 x 22 mm  
**35-022-12**



**35-022-02** 25,0 cm, 9 3/4"  
**35-022-12** 31,0 cm, 12 1/4"



60 x 22 mm  
**35-022-03**

isoliert  
insulated  
aislado  
isolato

72 x 22 mm  
**35-022-13**

isoliert  
insulated  
aislado  
isolato

**35-022-03** 25,0 cm, 9 3/4"  
**35-022-13** 31,0 cm, 12 1/4"



konisch, für Jungfrauen  
 conical blades, for virgins  
 valvos cónicos, para vírgenes  
 valve coniche, per vergini

### KRISTELLER

**35-030-00** Fig. 0

**35-030-01** Fig. 1

**35-030-02** Fig. 2

**35-030-03** Fig. 3

Satz  
 Set  
 Juego  
 Set

### KRISTELLER

**35-031-00** 70 x 15 mm

**35-031-01** 70 x 27 mm

**35-031-02** 80 x 30 mm

**35-031-03** 90 x 36 mm

Spekula allein  
 Specula only  
 Espéculos suelto  
 Solo speculi

### KRISTELLER

**35-032-00** 70 x 15 mm

**35-032-01** 75 x 23 mm

**35-032-02** 85 x 26 mm

**35-032-03** 100 x 32 mm

Halter allein  
 Retractor only  
 Valvas suelto  
 Solo valve

### KRISTELLER

**35-040-01** Fig. 00

**35-040-02** Fig. 0

Satz  
 Set  
 Juego  
 Set

### KRISTELLER

**35-041-01** 105 x 18 mm

**35-041-02** 105 x 21 mm

Spekula allein  
 Specula only  
 Espéculos suelto  
 Solo speculi

### KRISTELLER

**35-042-01** 110 x 14 mm

**35-042-02** 110 x 17 mm

Halter allein  
 Retractor only  
 Valvas suelto  
 Solo valve



### KRISTELLER

**35-050-01** Fig. 1

**35-050-02** Fig. 2

**35-050-03** Fig. 3

Satz  
Set  
Juego  
Set

### KRISTELLER

**35-051-01** 110 x 27 mm

**35-051-02** 110 x 30 mm

**35-051-03** 110 x 36 mm

Spekula allein, tief  
Specula only, deep  
Espéculos suelto, con huecos profundos  
Solo speculi, profonda

### KRISTELLER

**35-052-01** 115 x 23 mm

**35-052-02** 115 x 26 mm

**35-052-03** 115 x 32 mm

Halter allein  
Retractor only  
Valvas suelto  
Solo valve



### KRISTELLER

**35-060-01** Fig. 1

**35-060-02** Fig. 2

**35-060-03** Fig. 3

Satz  
Set  
Juego  
Set

### KRISTELLER

**35-061-01** 105 x 26 mm

**35-061-02** 105 x 28 mm

**35-061-03** 105 x 33 mm

Spekula allein, flach  
Specula only, flat  
Espéculos suelto, con huecos planos  
Solo speculi, piatta

### KRISTELLER

**35-062-01** 115 x 22 mm

**35-062-02** 115 x 24 mm

**35-062-03** 115 x 29 mm

Halter allein  
Retractor only  
Valvas suelto  
Solo valve



### KRISTELLER MOD. WIEN

**35-064-01** Fig. 1

**35-064-02** Fig. 2

**35-064-03** Fig. 3

Satz  
Set  
Juego  
Set

### KRISTELLER MOD. WIEN

**35-065-01** 110 x 20 mm

**35-065-02** 110 x 30 mm

**35-065-03** 110 x 36 mm

Spekula allein  
Specula only  
Espéculos suelto  
Solo speculi

### KRISTELLER MOD. WIEN

**35-066-01** 115 x 18 mm

**35-066-02** 115 x 26 mm

**35-066-03** 115 x 32 mm

Halter allein  
Retractor only  
Valvas suelto  
Solo valve

### KALLMORGEN

**35-070-01** Fig. 1

**35-070-02** Fig. 2

Satz  
Set  
Juego  
Set

### KALLMORGEN

**35-070-11** 70 x 40 mm

**35-070-12** 90 x 40 mm

Spekula allein, flach  
Specula only, flat  
Espéculos suelto, con huecos planos  
Solo speculi, piatta

### KALLMORGEN

**35-070-21** 70 x 33 mm

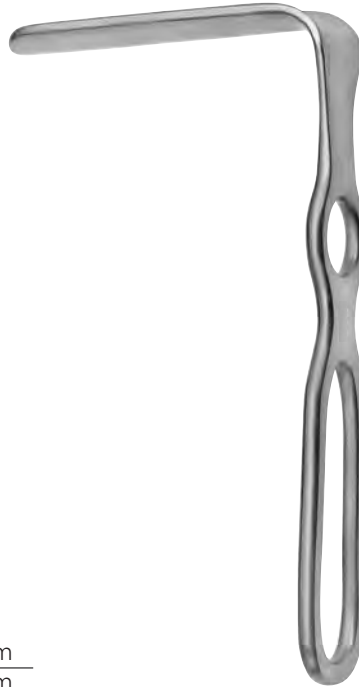
**35-070-22** 90 x 33 mm

Halter allein  
Retractor only  
Valvas suelto  
Solo valve



**MATZNAUER**

<b>35-073-01</b>	90 x 20 mm
<b>35-073-02</b>	100 x 10 mm
<b>35-073-03</b>	100 x 15 mm
<b>35-073-04</b>	100 x 20 mm
<b>35-073-05</b>	100 x 25 mm



**MATZNAUER**

<b>35-074-01</b>	130 x 20 mm
<b>35-074-02</b>	130 x 25 mm
<b>35-074-03</b>	130 x 30 mm
<b>35-074-04</b>	130 x 35 mm
<b>35-074-05</b>	130 x 40 mm



**LANDON**

<b>35-078-01</b>	89 x 25 mm
------------------	------------

**BRAUN**

<b>35-079-01</b>	56 x 13 mm
------------------	------------



**BRAUN**

<b>35-079-02</b>	60 x 10 mm
------------------	------------



Spekula allein  
Specula only  
Espéculos suelto  
Solo speculi

**MATHIEU**

<b>35-080-01</b>	95 x 17-30 mm
------------------	---------------



Halter allein  
Retractor only  
Valvas suelto  
Solo valve

**MATHIEU**

<b>35-080-02</b>	95 x 17-26 mm
------------------	---------------



**DOYEN**

<b>35-081-01</b>	60 x 45 mm
<b>35-081-02</b>	90 x 45 mm
<b>35-081-03</b>	112 x 45 mm



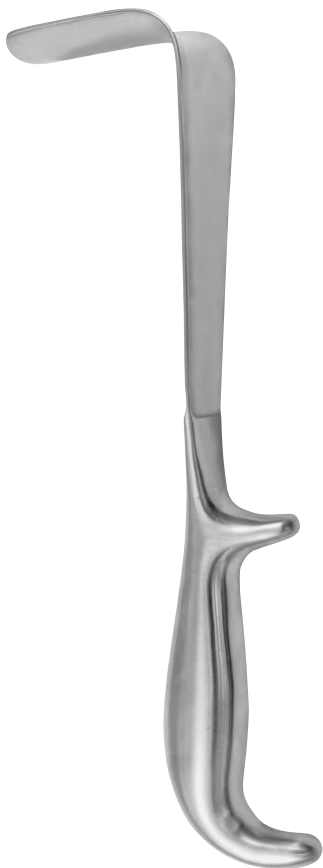
**DOYEN**

<b>35-081-60</b>	60 x 30 mm
<b>35-081-70</b>	70 x 30 mm
<b>35-081-80</b>	80 x 30 mm



**JACKSON**

<b>35-085-01</b>	75 x 35 mm
<b>35-085-02</b>	90 x 35 mm
<b>35-085-03</b>	100 x 35 mm



**DOYEN**

<b>35-082-01</b>	55 x 35 mm
<b>35-082-02</b>	85 x 35 mm
<b>35-082-03</b>	115 x 35 mm

**DOYEN**

<b>35-083-01</b>	55 x 45 mm
<b>35-083-02</b>	85 x 45 mm
<b>35-083-03</b>	115 x 45 mm
<b>35-083-04</b>	160 x 45 mm

**DOYEN**

<b>35-084-01</b>	55 x 60 mm
<b>35-084-02</b>	85 x 60 mm
<b>35-084-03</b>	115 x 60 mm
<b>35-084-04</b>	160 x 60 mm



**LANDAU**

<b>35-086-28</b>	100 x 28 mm
<b>35-086-38</b>	100 x 38 mm



**BREISKY**

<b>35-087-15</b>	100 x 15 mm
<b>35-087-20</b>	100 x 20 mm
<b>35-087-25</b>	100 x 25 mm
<b>35-087-30</b>	100 x 30 mm
<b>35-087-35</b>	100 x 35 mm
<b>35-087-40</b>	100 x 40 mm



**BREISKY MOD. WIEN**

<b>35-088-20</b>	130 x 20 mm
<b>35-088-25</b>	130 x 25 mm
<b>35-088-30</b>	130 x 30 mm
<b>35-088-35</b>	130 x 35 mm
<b>35-088-40</b>	130 x 40 mm
<b>35-089-40</b>	160 x 40 mm
<b>35-090-40</b>	180 x 40 mm

**SCHERBACK**

**35-091-00** SET

Satz, komplett mit 5 Valven 35-092-01 – 35-092-05 und Griff  
Set, complete with 5 valves 35-092-01 – 35-092-05 and handle  
Juego, completo con 5 valvas 35-092-01 – 35-092-05 y mango  
Set, completo con 5 valvas 35-092-01 – 35-092-05 e manico

**SCHERBACK**

**35-092-00** SET

Satz, komplett mit 4 Valven 35-092-01 – 35-092-04 und Griff  
Set, complete with 4 valves 35-092-01 – 35-092-04 and handle  
Juego, completo con 4 valvas 35-092-01 – 35-092-04 y mango  
Set, completo con 4 valvas 35-092-01 – 35-092-04 e manico

**35-092-12**

Griff  
Handle  
Mango  
Manico



80 x 30 mm

**35-092-01**



85 x 35 mm

**35-092-02**



90 x 40 mm

**35-092-03**



55 x 40 | 60 mm

**35-092-04**



70 X 45 | 70 mm

**35-092-05**

**35-092-10** 400,0 g

**35-092-11** 800,0 g

Gewicht  
Weight  
Peso  
Peso





mit festem Gewicht  
 with fixed weight  
 con peso fijo  
 con peso fisso

### AUVARD

**35-093-00** 83 x 38 mm



mit abnehmbarem Gewicht  
 with detachable weight  
 con peso desmontable  
 con peso smontabile

### AUVARD

**35-093-01** 80 x 38 mm

**35-093-02** 102 x 45 mm

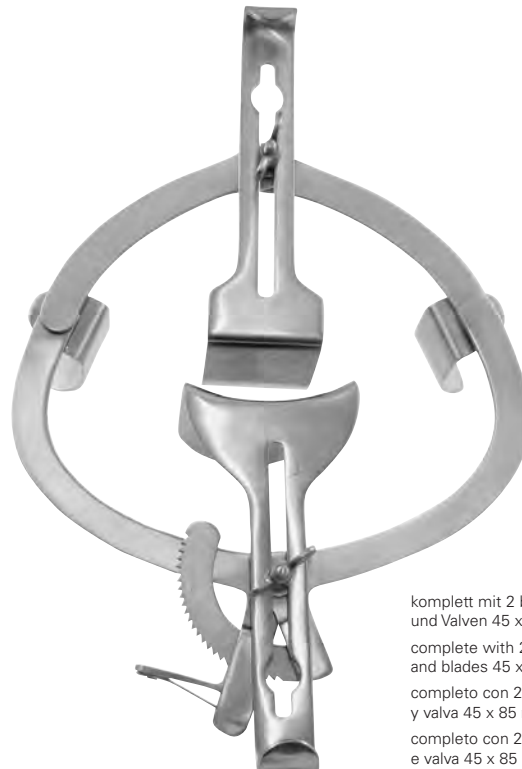


### 35-094-99

abnehmbares Auffangsieb  
 removable colander  
 tamiz desmontable  
 filtro smontabile e fondo forato

### WEISSBARTH

**35-094-00** 80 x 42 mm



komplett mit 2 beweglichen Valven 25 x 60 mm  
 und Valven 45 x 85 mm | 70 x 105 mm  
 complete with 2 rotatable blades 25 x 60 mm  
 and blades 45 x 85 mm | 70 x 105 mm  
 completo con 2 valvas móviles 25 x 60 mm  
 y valva 45 x 85 mm | 70 x 105 mm  
 completo con 2 valve mobili 25 x 60 mm  
 e valva 45 x 85 mm | 70 x 105 mm

### O'SULLIVAN - O'CONNOR

**35-095-00**



**FRIEDMANN-JOLL**

**35-096-00** 105,0 mm

**35-097-00** 155,0 mm

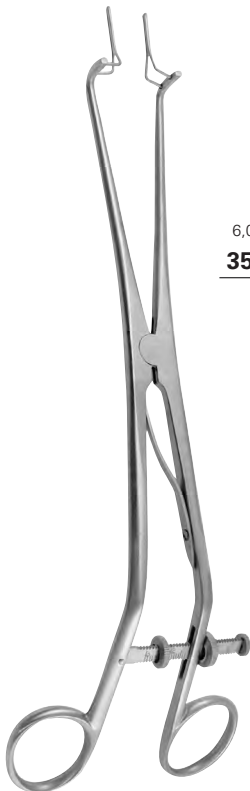


6,0 x 20,0 mm

**35-097-24**

**KOGAN**

**35-097-24** 24,0 cm, 9 ½"

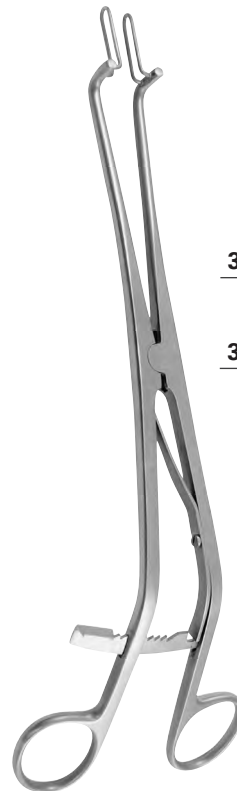


6,0 x 20,0 mm

**35-098-24**

**KOGAN**

**35-098-24** 24,0 cm, 9 ½"



3,0 mm

**35-099-24**

6,0 mm

**35-099-25**

**KOGAN**

**35-099-24 - 35-099-25** 27,0 cm, 10 ¾"



## HEGAR

**35-106-14** 4,0 - 17,0 mm

Satz 35-100-04 – 35-100-17 | 14 St.  
 Set 35-100-04 – 35-100-17 | 14 pcs.  
 Juego 35-100-04 – 35-100-17 | 14 piezas  
 Set 35-100-04 – 35-100-17 | 14 pz.



## HEGAR

<b>35-100-01</b>	Ø 1,0 mm
<b>35-100-02</b>	Ø 2,0 mm
<b>35-100-03</b>	Ø 3,0 mm
<b>35-100-04</b>	Ø 4,0 mm
<b>35-100-05</b>	Ø 5,0 mm
<b>35-100-06</b>	Ø 6,0 mm
<b>35-100-07</b>	Ø 7,0 mm
<b>35-100-08</b>	Ø 8,0 mm
<b>35-100-09</b>	Ø 9,0 mm
<b>35-100-10</b>	Ø 10,0 mm
<b>35-100-11</b>	Ø 11,0 mm
<b>35-100-12</b>	Ø 12,0 mm
<b>35-100-13</b>	Ø 13,0 mm
<b>35-100-14</b>	Ø 14,0 mm
<b>35-100-15</b>	Ø 15,0 mm

## HEGAR

**35-106-26** 1,0 - 26,0 mm

Satz 35-100-01 – 35-100-26 | 26 St.  
 Set 35-100-01 – 35-100-26 | 26 pcs.  
 Juego 35-100-01 – 35-100-26 | 26 piezas  
 Set 35-100-01 – 35-100-26 | 26 pz.

## HEGAR

<b>35-100-16</b>	Ø 16,0 mm
<b>35-100-17</b>	Ø 17,0 mm
<b>35-100-18</b>	Ø 18,0 mm
<b>35-100-19</b>	Ø 19,0 mm
<b>35-100-20</b>	Ø 20,0 mm
<b>35-100-21</b>	Ø 21,0 mm
<b>35-100-22</b>	Ø 22,0 mm
<b>35-100-23</b>	Ø 23,0 mm
<b>35-100-24</b>	Ø 24,0 mm
<b>35-100-25</b>	Ø 25,0 mm
<b>35-100-26</b>	Ø 26,0 mm
<b>35-100-27</b>	Ø 27,0 mm
<b>35-100-28</b>	Ø 28,0 mm
<b>35-100-29</b>	Ø 29,0 mm
<b>35-100-30</b>	Ø 30,0 mm

## HEGAR

<b>35-105-01</b>	Ø 1,5 mm
<b>35-105-02</b>	Ø 2,5 mm
<b>35-105-03</b>	Ø 3,5 mm
<b>35-105-04</b>	Ø 4,5 mm
<b>35-105-05</b>	Ø 5,5 mm
<b>35-105-06</b>	Ø 6,5 mm
<b>35-105-07</b>	Ø 7,5 mm
<b>35-105-08</b>	Ø 8,5 mm
<b>35-105-09</b>	Ø 9,5 mm
<b>35-105-10</b>	Ø 10,5 mm
<b>35-105-11</b>	Ø 11,5 mm
<b>35-105-12</b>	Ø 12,5 mm
<b>35-105-13</b>	Ø 13,5 mm
<b>35-105-14</b>	Ø 14,5 mm
<b>35-105-15</b>	Ø 15,5 mm
<b>35-105-16</b>	Ø 16,5 mm
<b>35-105-17</b>	Ø 17,5 mm
<b>35-105-18</b>	Ø 18,5 mm
<b>35-105-19</b>	Ø 19,5 mm

## HEGAR

**35-107-14** 4,0 - 17,0 mm

Satz 35-100-04 – 35-100-17 | 14 St.  
 Set 35-100-04 – 35-100-17 | 14 pcs.  
 Juego 35-100-04 – 35-100-17 | 14 piezas  
 Set 35-100-04 – 35-100-17 | 14 pz.

**35-107-15** 4,0 - 17,0 mm

Metalletui und Lagerungssieb, allein  
 Metal case and rack, only  
 Estuche de metal y soporte, suelta  
 Scatola metallica e supporto, solo

**35-107-16** 4,0 - 17,0 mm

Metalletui 205 x 105 x 15 mm, allein  
 Metal case 205 x 105 x 15 mm, only  
 Estuche de metal 205 x 105 x 15 mm, suelta  
 Scatola metallica 205 x 105 x 15 mm, solo

**35-107-20** 4,0 - 12,0 mm

**35-107-21** 13,0 - 17,0 mm

Lagerungssieb, allein  
 Rack, only  
 Soporte, suelta  
 Supporto, solo

## HEGAR

**35-107-26** 1,0 - 26,0 mm

Satz 35-100-01 – 35-100-26 | 26 St.  
 Set 35-100-01 – 35-100-26 | 26 pcs.  
 Juego 35-100-01 – 35-100-26 | 26 piezas  
 Set 35-100-01 – 35-100-26 | 26 pz.

**35-107-27** 1,0 - 26,0 mm

Metalletui und Lagerungssieb, allein  
 Metal case and rack, only  
 Estuche de metal y soporte, suelta  
 Scatola metallica e supporto, solo

**35-107-17** 1,0 - 26,0 mm

Metalletui 310 x 210 x 55 mm, allein  
 Metal case 310 x 210 x 55 mm, only  
 Estuche de metal 310 x 210 x 55 mm, suelta  
 Scatola metallica 310 x 210 x 55 mm, solo

**35-107-22** 1,0 - 17,0 mm

**35-107-23** 18,0 - 26,0 mm

Lagerungssieb, allein  
 Rack, only  
 Soporte, suelta  
 Supporto, solo





**HEGAR**

**35-111-01** 3/4 - 17/18 mm

Satz 35-110-04 – 35-110-18 | 8 St.  
Set 35-110-04 – 35-110-18 | 8 pcs.  
Juego 35-110-04 – 35-110-18 | 8 piezas  
Set 35-110-04 – 35-110-18 | 8 pz.

**HEGAR**

**35-111-02** 1/2 - 25/26 mm

Satz 35-110-02 – 35-110-26 | 13 St.  
Set 35-110-02 – 35-110-26 | 13 pcs.  
Juego 35-110-02 – 35-110-26 | 13 piezas  
Set 35-110-02 – 35-110-26 | 13 pz.

**HEGAR**

**35-110-02** Ø 1 - 2 mm

**35-110-04** Ø 3 - 4 mm

**35-110-06** Ø 5 - 6 mm

**35-110-08** Ø 7 - 8 mm

**35-110-10** Ø 9 - 10 mm

**35-110-12** Ø 11 - 12 mm

**35-110-14** Ø 13 - 14 mm

**35-110-16** Ø 15 - 16 mm

**35-110-18** Ø 17 - 18 mm

**35-110-20** Ø 19 - 20 mm

**35-110-22** Ø 21 - 22 mm

**35-110-24** Ø 23 - 24 mm

**35-110-26** Ø 25 - 26 mm



**HEGAR**

**35-111-03** 3/4 - 17/18 mm

Satz 35-110-04 – 35-110-18 | 8 St.  
Set 35-110-04 – 35-110-18 | 8 pcs.  
Juego 35-110-04 – 35-110-18 | 8 piezas  
Set 35-110-04 – 35-110-18 | 8 pz.



**HEGAR**

**35-111-08** 1/2 - 25/26 mm

Satz 35-110-02 – 35-110-26 | 13 St.  
Set 35-110-02 – 35-110-26 | 13 pcs.  
Juego 35-110-02 – 35-110-26 | 13 piezas  
Set 35-110-02 – 35-110-26 | 13 pz.



**35-120-32**

rigida  
rigido



**35-121-32**

maleabile  
malleabile



### SIMS

**35-120-32 - 35-121-32** 32,0 cm, 12 1/2"



**35-122-32**

rigida  
rigido



**35-123-32**

maleabile  
malleabile



### MARTIN

**35-122-32 - 35-123-32** 32,0 cm, 12 1/2"



### VALLEIX

**35-125-25** 29,5 cm, 11 1/2"



Uterus-Depressor  
 Uterine Depressor  
 Depresores uterinos  
 Depressori uterini

**BRAUN**

**35-200-26** 28,0 cm, 11 "



Uterus-Depressor  
 Uterine Depressor  
 Depresores uterinos  
 Depressori uterini

**SIMS**

**35-201-26** 26,0 cm, 10 ¼ "



stumpf  
 blunt  
 romas  
 smusse



scharf  
 sharp  
 cortantes  
 acute

Uteruskürette  
 Uterine curette  
 Curete uterina  
 Curette uterine

**BLAKE**

**35-202-27** 28,0 cm, 11 "



**35-204-25**

**SCHROEDER**

**35-204-25** 25,0 cm, 9 3/4"



**35-206-25**

**BRAUN**

**35-206-25** 25,0 cm, 9 3/4"



**35-208-17**

**STAUDE-MOORE**

**35-208-17** 17,0 cm, 6 3/4"



**35-209-28**

**DUPLAY**

**35-209-28** 28,0 cm, 11"



**35-210-18**

**POZZI**

**35-210-18** 18,0 cm, 7"



**35-210-26**

**POZZI**

**35-210-26** 25,5 cm, 10"





**35-211-24**

**SKENE**

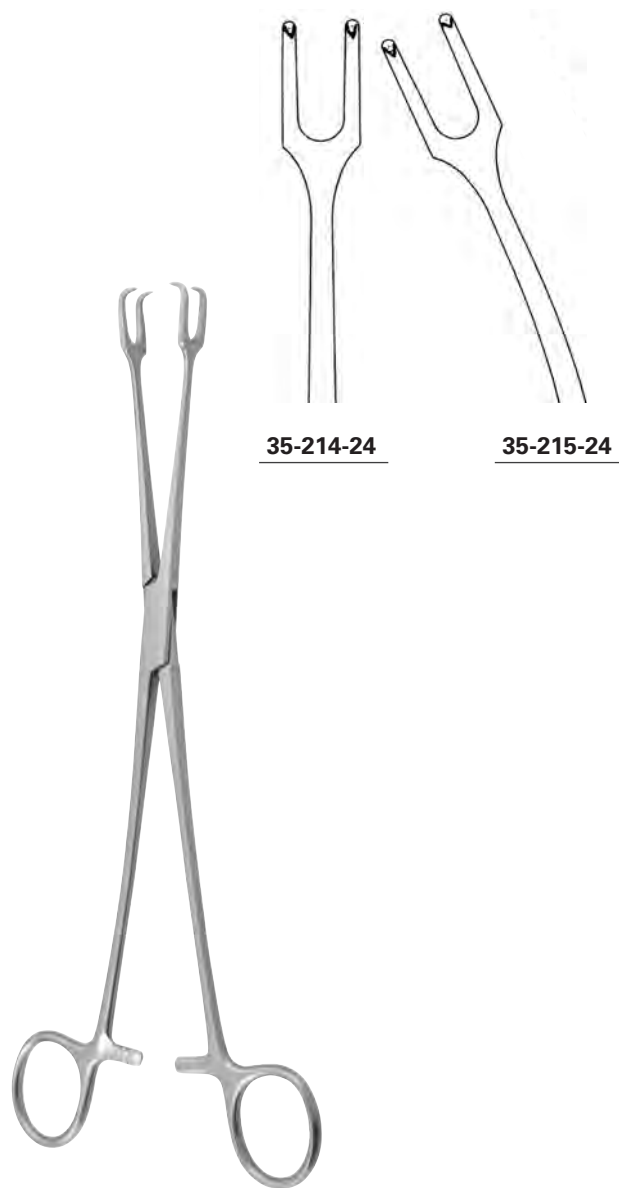
**35-211-24** 24,0 cm, 9 ½"



Amniotom  
 Amniotome  
 Amniótomo  
 Amniotomo

**BEACHAM**

**35-212-26** 26,0 cm, 10 ¼"



**35-214-24**

**35-215-24**

**SCHROEDER**

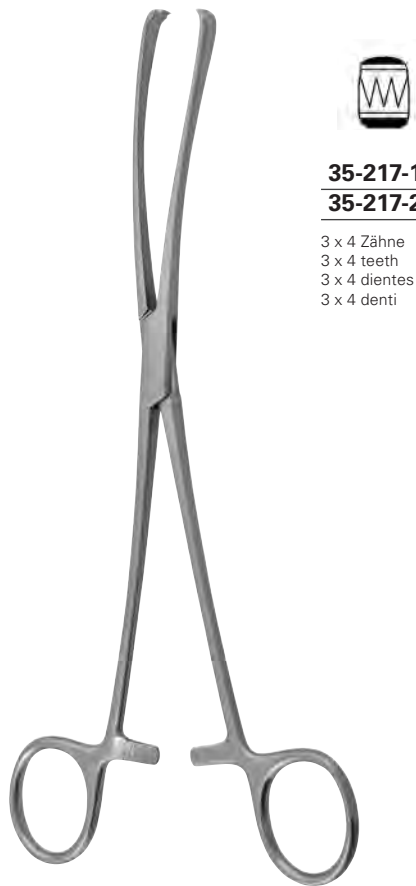
**35-214-24 - 35-215-24** 24,0 cm, 9 ½"



**35-216-24**

**WILSON**

**35-216-24** 24,0 cm, 9 ½"



**35-217-18**  
**35-217-23**

3 x 4 Zähne  
 3 x 4 teeth  
 3 x 4 dientes  
 3 x 4 denti

**TEALE**

**35-217-18** 18,0 cm, 7"  
**35-217-23** 23,0 cm, 9"



**35-218-25**

2 x 3 Zähne  
 2 x 3 teeth  
 2 x 3 dientes  
 2 x 3 denti

**KUESTNER**

**35-218-25** 25,0 cm, 9 ¾"

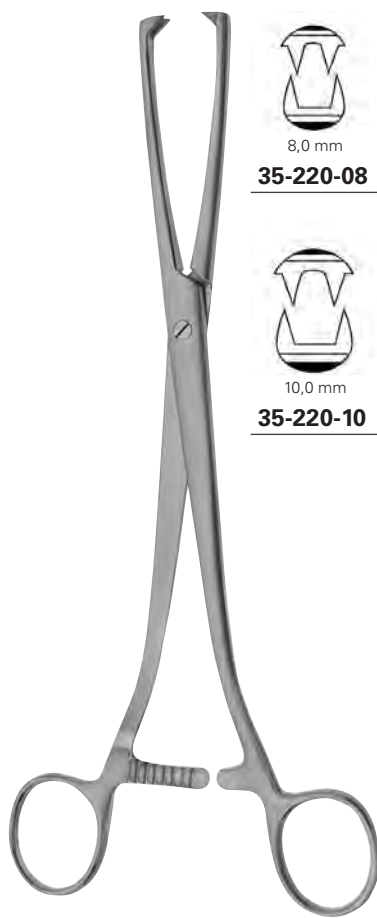
Hakenzangen  
Uterine tenaculum forceps  
Pinzas para coger el cuello de útero  
Pinze per abbassare il collo dell'utero



**35-219-26**

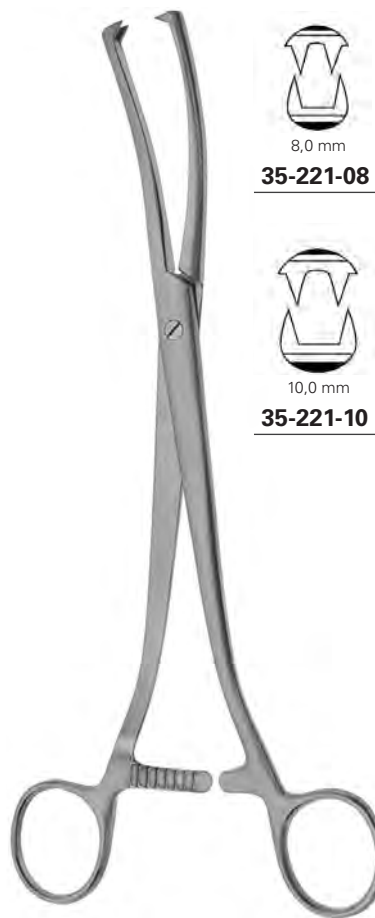
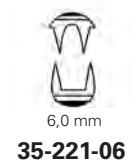
**IOWA**

**35-219-26** 26,0 cm, 10 1/4"



**MUSEUX**

**35-220-06 - 35-220-10** 24,0 cm, 9 1/2"



**MUSEUX**

**35-221-06 - 35-221-10** 24,0 cm, 9 1/2"



**35-222-20**

**MUSEUX**

**35-222-20** 20,0 cm, 8"



**35-222-21**

**JACOBS**

**35-222-21** 21,0 cm, 8 ¼"



**35-223-21**

**JACOBS**

**35-223-21** 21,0 cm, 8 ¼"



**35-226-21**

**CZERNY**

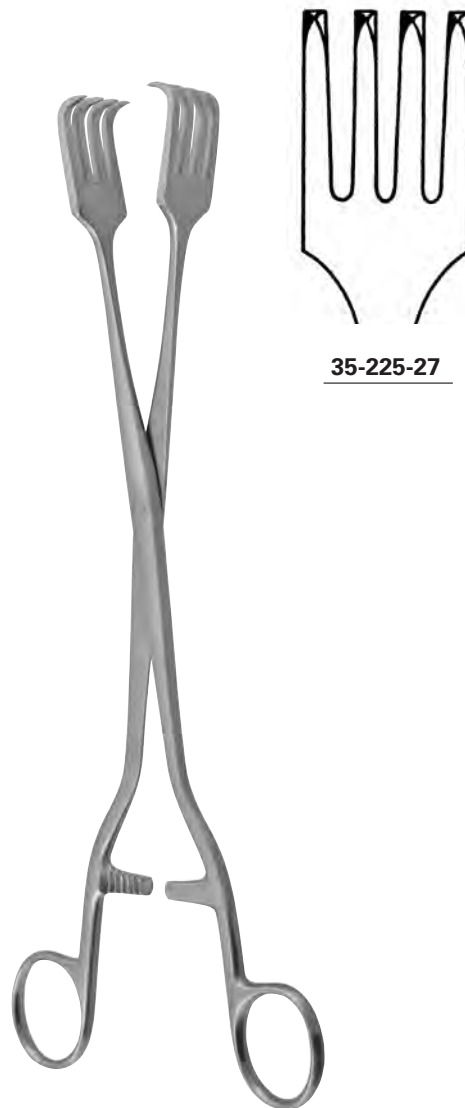
**35-226-21** 20,5 cm, 8"



35-224-28

**PRATT**

35-224-28 26,0 cm, 10 $\frac{1}{4}$ "



35-225-27

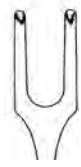
**PRATT**

35-225-27 27,0 cm, 10 $\frac{3}{4}$ "



**SCHROEDER**

35-226-27 27,0 cm, 10 $\frac{3}{4}$ "



**35-228-01**



**LAHEY**

**35-228-01** 15,0 cm, 6"

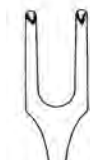


**35-228-03**



**BRAUN**

**35-228-03** 15,5 cm, 6 1/8"



**35-228-04**



**MUSEUX**

**35-228-04** 20,0 cm, 8"



Ø 25,0 mm  
**35-233-17**

**DOYEN**

**35-233-17** 16,5 cm, 6 1/2"



Ø 20,0 mm  
**35-234-17**

**DOYEN**

**35-234-17** 17,0 cm, 6 3/4"



**DARTIGUES**

**35-230-27** 27,0 cm, 10 $\frac{3}{4}$ "



**SOMER**

**35-231-23** 23,0 cm, 9"



**COLLIN**

**35-232-25** 25,0 cm, 9 <sup>3</sup>/<sub>4</sub> "



**COLLIN**

**35-236-25** 25,0 cm, 9 <sup>3</sup>/<sub>4</sub> "



Uteruslöffel, Instrument für die Entfernung von Spiralen  
 Uterine scoops, Instrument for removal of I.U.D  
 Curettes uterines, Instrumento para remoer dispositivo tintrauterino  
 Cucchiali uterine, Strumento per la rimozione dell I.U.D.



Instrument für die Entfernung von Spiralen  
 Instrument for removal of I.U.D  
 Instrumento para remoer dispositivo tintrauterino  
 Strumento per la rimozione dell I.U.D.



**35-302-20**

Sekretlöffel  
 Secretion scoop  
 Curette secreción  
 Cucchiaio secreto

**ASCH**

**35-302-20** 20,0 cm, 8"



**35-302-27**

Sekretlöffel  
 Secretion scoop  
 Curette secreción  
 Cucchiaio secreto

**35-302-27** 27,0 cm, 10<sup>3</sup>/<sub>4</sub>"



**35-302-42**

Uteruslöffel  
 Uterine scoop  
 Curette uterine  
 Cucchiaio uterine

**WALLICH**

**35-302-42** 42,0 cm, 10<sup>1</sup>/<sub>2</sub>"

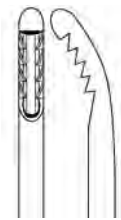


**35-304-32**



**SAUNDERS**

**35-304-32** 32,0 cm, 16<sup>1</sup>/<sub>2</sub>"



<b>35-301-01</b>	Ø 1,0 mm
<b>35-301-02</b>	Ø 2,0 mm
<b>35-301-03</b>	Ø 3,0 mm
<b>35-301-04</b>	Ø 4,0 mm



Ø 4,0 mm  
**35-303-04**



3,0 mm  
**35-305-04**



3,0 mm  
**35-306-04**

**NOVAK**

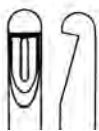
**35-301-01 - 35-301-04** 23,0 cm, 9"

**RANDALL**

**35-303-04** 25,0 cm, 9 ¾"

**KEVORKIAN**

**35-305-04 - 35-306-04** 30,0 cm, 11 ¾"

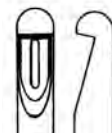


Ø 3,5 mm

**35-307-03**

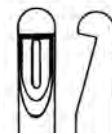
**MOD. BERLIN**

**35-307-03** 27,0 cm, 10<sup>3</sup>/<sub>4</sub>"



Ø 4,0 mm

**35-307-04**



Ø 5,0 mm

**35-307-05**

**MOD. MUENCHEN**

**35-307-04 - 35-307-05** 27,0 cm, 10<sup>3</sup>/<sub>4</sub>"



<b>35-308-05</b>	Ø 5,0 mm
<b>35-308-07</b>	Ø 7,0 mm
<b>35-308-09</b>	Ø 9,0 mm

Biopsieküretten, biegsam  
 Biopsy curettes, malleable  
 Curetas para biopsia, maleable  
 Curette per biopsia, malleabile

<b>35-308-15</b>	Ø 5,0 mm
<b>35-308-17</b>	Ø 7,0 mm
<b>35-308-19</b>	Ø 9,0 mm

Biopsieküretten, starr  
 Biopsy curettes, rigid  
 Curetas para biopsia, rigida  
 Curette per biopsia, rigido



<b>35-309-03</b>	Ø 3,0 mm
<b>35-309-04</b>	Ø 4,5 mm
<b>35-309-06</b>	Ø 6,0 mm
<b>35-309-08</b>	Ø 8,0 mm
<b>35-309-10</b>	Ø 10,0 mm
<b>35-309-12</b>	Ø 12,0 mm
<b>35-309-14</b>	Ø 14,0 mm



**35-309-50**  
 Kupplungsstück  
 Connecting piece  
 Pieza de acoplamiento  
 Pezzo di collegamento

**MILAN**

**35-308-05 - 35-308-19** 28,5 cm, 11 ¼"

**35-309-03 - 35-309-14** 28,5 cm, 11 ¼"



**35-310-01**

Adapter, klein  
 Adaptor, small  
 Adattatore, pequeño  
 Adattatore, piccolo

**35-310-02**

Adapter, groß  
 Adaptor, large  
 Adattatore, grande  
 Adattatore, grande

Uterus Känüle komplett, mit Adapter  
 35-310-01 und 35-310-02  
 Uterine cannula complete, with adaptor  
 35-310-01 and 35-310-02  
 Cànula para uterine completo, con  
 adattatore 35-310-01 y 35-310-02  
 Cannule per uterine completo, con  
 adattatore 35-310-01 e 35-310-02

**COEN**

**35-310-00** SET



**35-330-99**

Tubenkatheter  
 Uterine cannula  
 Sonda para trompas  
 Cannula uterina

Komplett, im Holzetui  
 Complete, in wooden case  
 Completo, en estuche de madera  
 Completo, in scatola di legno

**SCHULTZE**

**35-320-00** SET



**35-340-03**

Verschlusskegel  
 Occlusive nozzle  
 Cono oclusión  
 Cono d'occlusionione



**35-340-04**

Verschlusskegel  
 Occlusive nozzle  
 Cono oclusión  
 Cono d'occlusionione



**35-340-05**

Verschlusskegel  
 Occlusive nozzle  
 Cono oclusión  
 Cono d'occlusionione



**35-340-00**

Manometer  
 Manometer  
 Manómetro  
 Manometro



**35-340-20**

Spritze, 10 ml  
 Syringe, 10 ml  
 Jeringa, 10 ml  
 Siringa, 10 ml



**35-340-01**

Verbindungsstück  
 Connecting piece  
 Pieza conectiva  
 Connessione

Komplett, ohne Manometer  
 Complete, without manometer  
 Completo, sin manómetro  
 Completo, senza manometro

**SCHULTZE**

**35-330-00** SET



35-401-21  
35-401-24

**FAURE**

<u>35-401-21</u>	21,0 cm, 8 ¼"
<u>35-401-24</u>	24,0 cm, 9 ½"

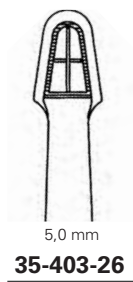


4,8 mm

35-402-21  
35-402-29

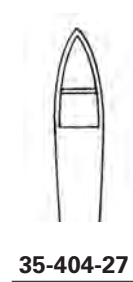
**SCHUBERT**

<u>35-402-21</u>	21,0 cm, 8 ¼"
<u>35-402-29</u>	29,0 cm, 11 ¼"



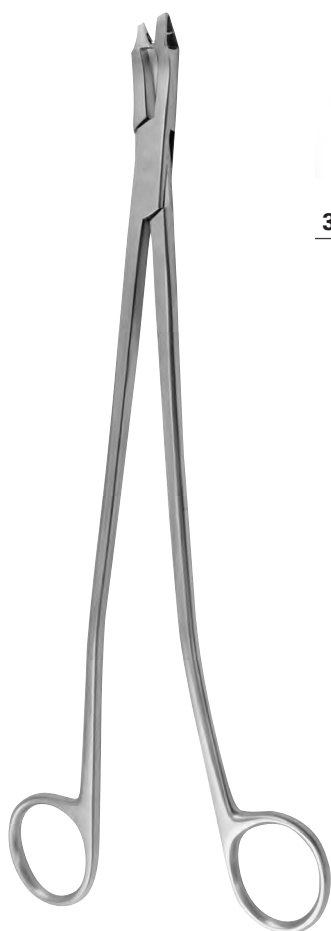
### SCHUBERT

**35-403-26** 26,0 cm, 10 $\frac{1}{4}$ "



### TISCHLER

**35-404-27** 27,0 cm, 10 $\frac{3}{4}$ "



**35-405-24**



**35-405-25**



**35-406-25**

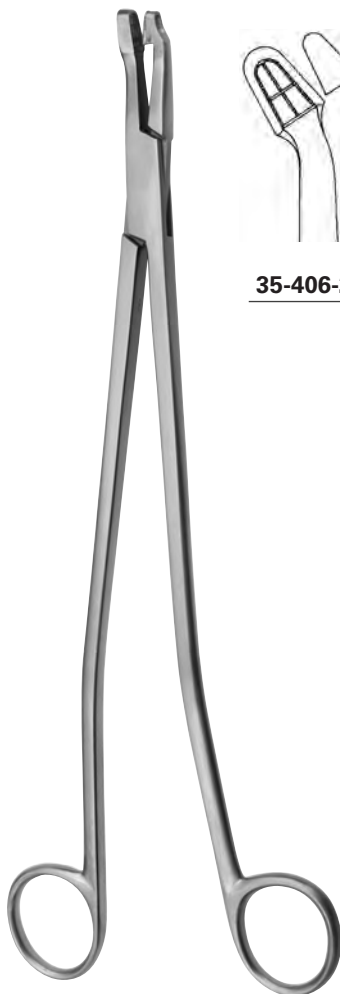
**SCHUMACHER-VAN DOREN**

**35-405-24 - 35-405-25** 24,0 cm, 9 1/2"

**VAN DOREN**

**35-406-25** 25,0 cm, 9 3/4"





**35-406-26**

**VAN DOREN**

**35-406-26** 25,0 cm, 9 3/4"



**35-407-24**

**THOMS-GAYLOR**

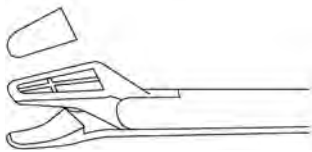
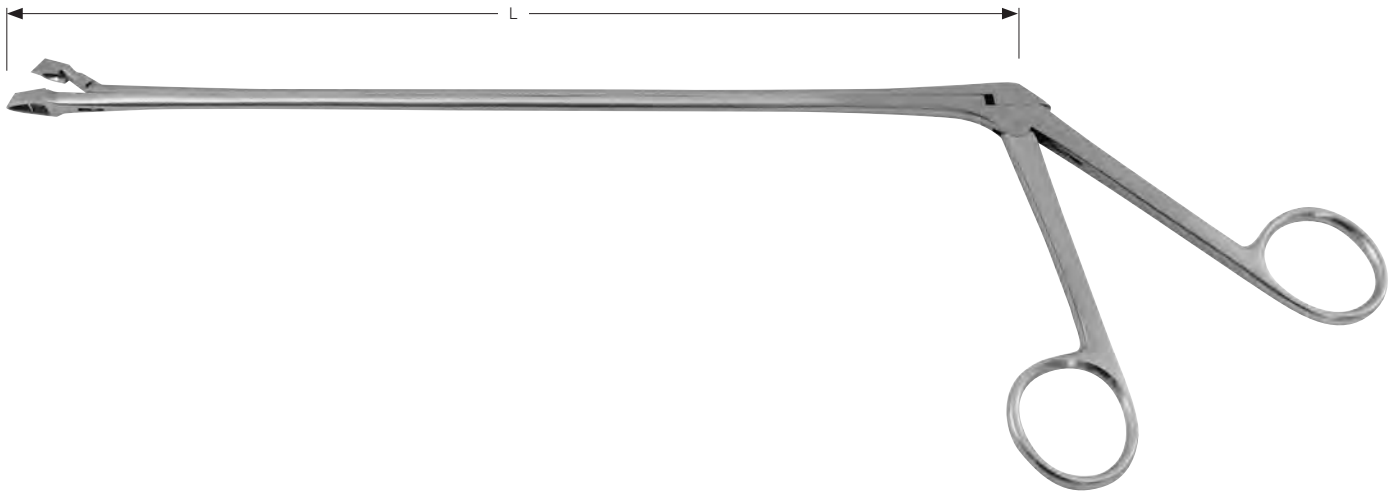
**35-407-24** 24,0 cm, 9 1/2"



**35-409-23**

**GELLHORN**

**35-409-23** 23,0 cm, 9"



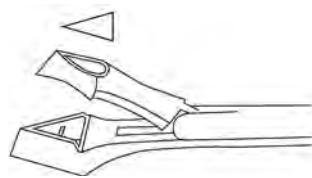
**ALEXANDER**

**35-410-28** 20,0 cm, 8"



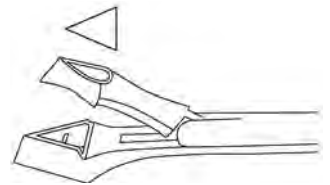
**DOUAY**

**35-411-20** 20,0 cm, 8"  
**35-411-25** 25,0 cm, 9 3/4"  
**35-411-30** 30,0 cm, 11 3/4"  
**35-411-35** 35,0 cm, 13 3/4"  
**35-411-40** 40,0 cm, 16"



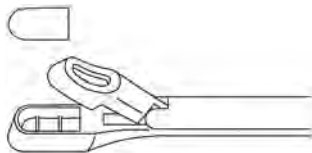
**SCHUMACHER**

**35-412-01** 24,0 cm, 9 1/4"



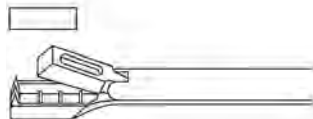
**SCHUMACHER**

**35-412-02** 24,0 cm, 9 1/4"



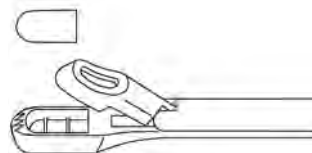
**EPPENDORF**

**35-414-20** 20,0 cm, 8"  
**35-414-23** 23,0 cm, 9"



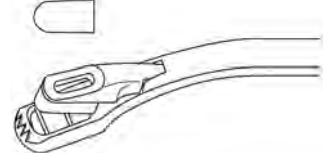
**KEVORKIAN**

**35-416-20** 20,0 cm, 8"  
**35-416-23** 23,0 cm, 9"  
**35-416-24** 25,0 cm, 9 3/4"



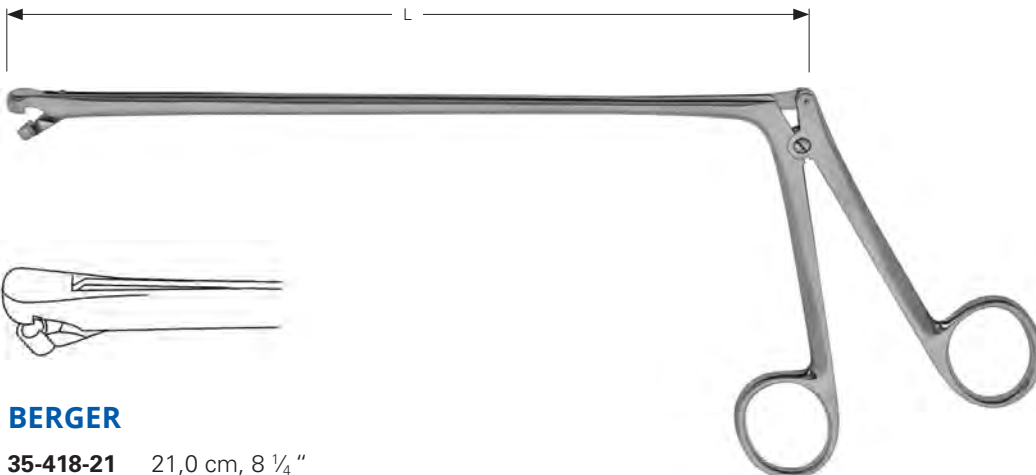
**WITTNER**

**35-420-23** 23,0 cm, 9"



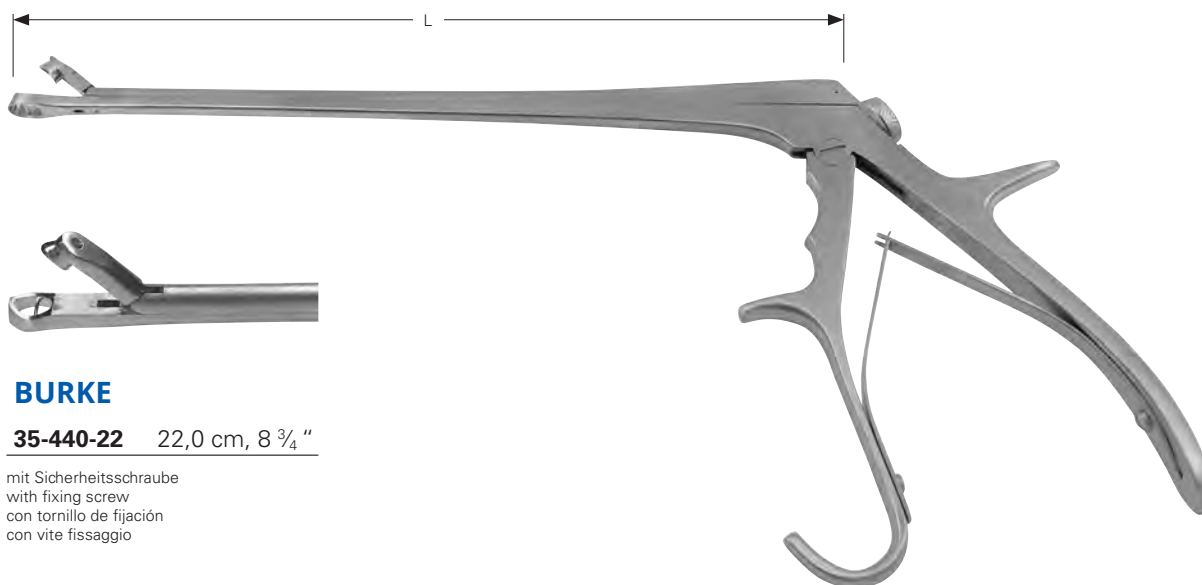
**WITTNER**

**35-421-23** 23,0 cm, 9"



**BERGER**

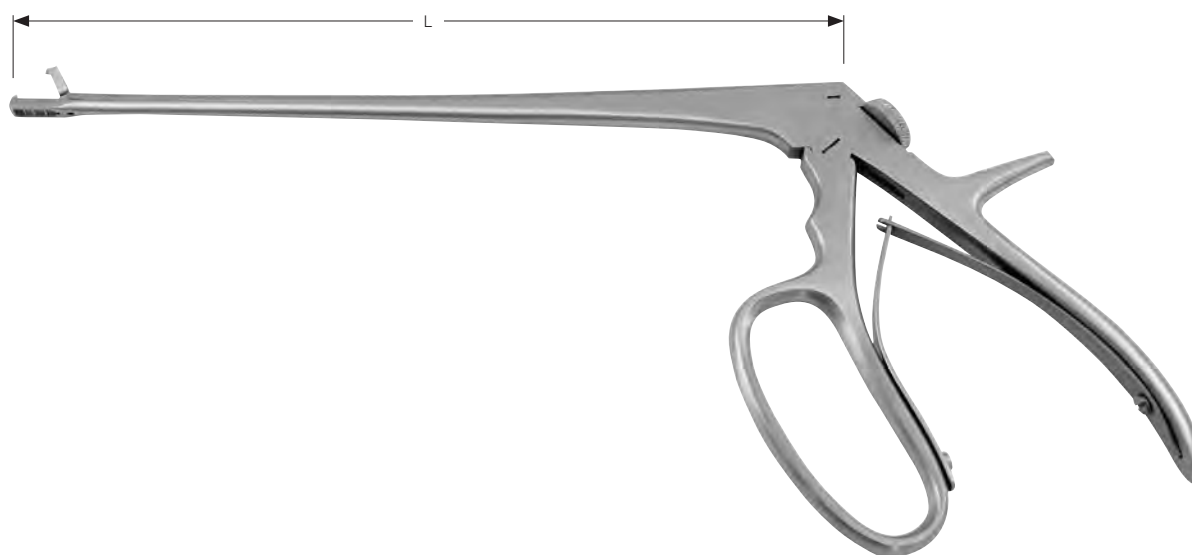
**35-418-21** 21,0 cm, 8 1/4"



### BURKE

**35-440-22** 22,0 cm, 8 3/4 "

mit Sicherheitsschraube  
 with fixing screw  
 con tornillo de fijación  
 con vite fissaggio



### TISCHLER-KEVORKIAN

**35-442-22** 22,0 cm, 8 3/4 "

mit Sicherheitsschraube  
 with fixing screw  
 con tornillo de fijación  
 con vite fissaggio



### KEVORKIAN-PACIFIC

**35-444-22** 22,0 cm, 8 3/4 "

mit Sicherheitsschraube  
 with fixing screw  
 con tornillo de fijación  
 con vite fissaggio



### TISCHLER

**35-446-22** 23,0 cm, 9 "

mit Sicherheitsschraube  
 with fixing screw  
 con tornillo de fijación  
 con vite fissaggio



### BABY-TISCHLER

**35-448-20** 20,0 cm, 8 "

mit Sicherheitsschraube  
 with fixing screw  
 con tornillo de fijación  
 con vite fissaggio



### BABY-TISCHLER

**35-448-21** 20,0 cm, 8 "

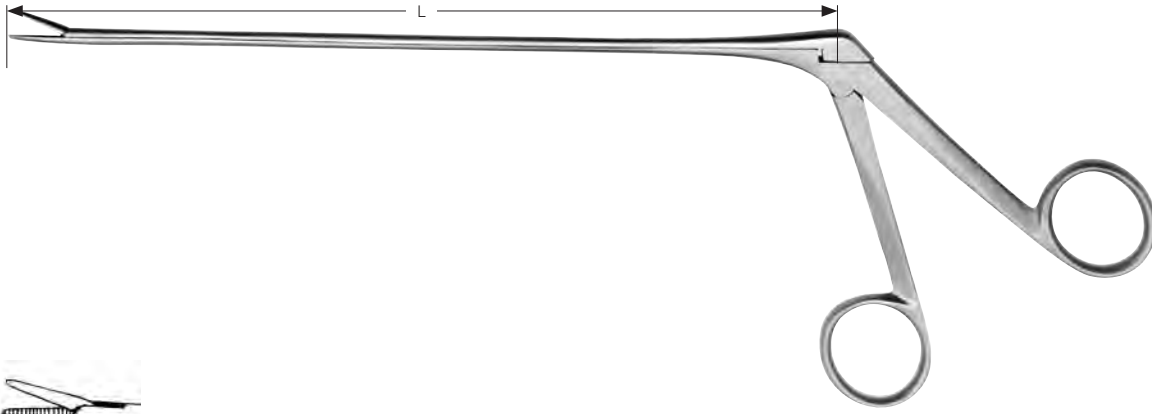
ohne Sicherheitsschraube  
 without fixing screw  
 sin tornillo de fijación  
 senza vite fissaggio



### TISCHLER-MORGAN

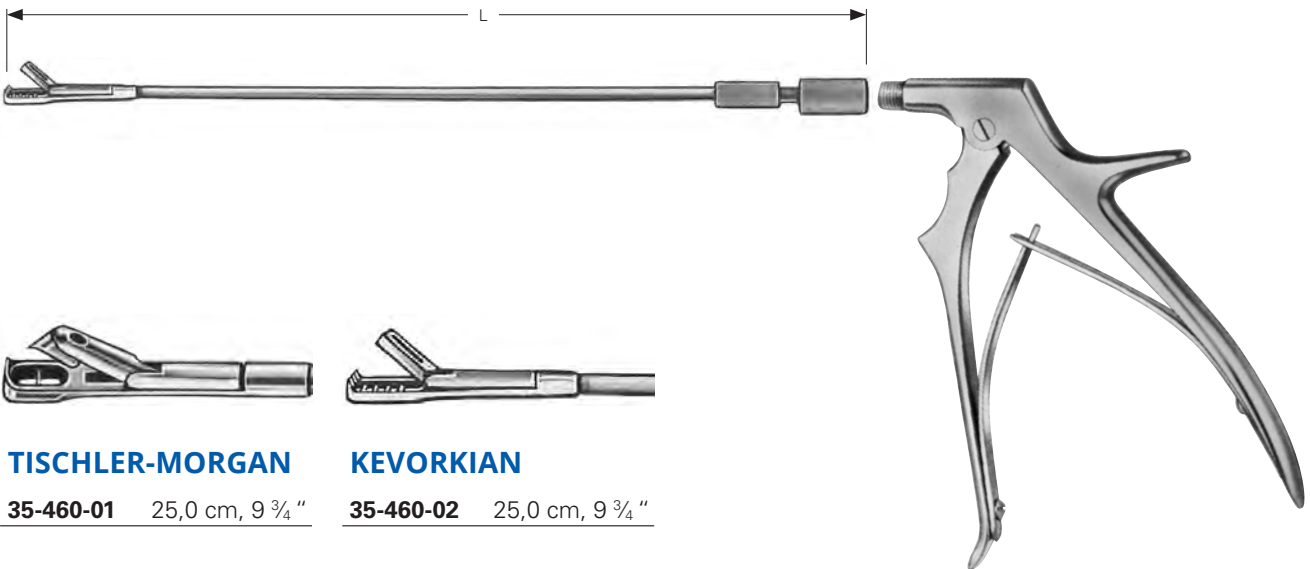
**35-450-22** 22,0 cm, 8 3/4 "

ohne Sicherheitsschraube  
 without fixing screw  
 sin tornillo de fijación  
 senza vite fissaggio



**35-455-20** 20,0 cm, 8"

Instrument für die Entfernung von Spiralen  
 Instrument for removal of I.U.D  
 Instrumento para remover dispositivo intrauterino  
 Strumento per la rimozione dell I.U.D.



**TISCHLER-MORGAN**

**35-460-01** 25,0 cm, 9 3/4"

**KEVORKIAN**

**35-460-02** 25,0 cm, 9 3/4"



**EPPENDORF**

**35-460-03** 25,0 cm, 9 3/4"



**MINI-TOWNSEND**

**35-460-05** 25,0 cm, 9 3/4"

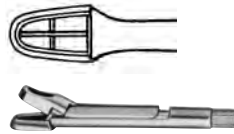
**35-460-00**

Griff  
 Handle  
 Mango  
 Manico



**35-470-00**

Universalgriff  
Universal Handle  
Mango universal  
Manico universale



**EPPENDORF**

**35-470-02**

Aufsatz  
Tip  
Punta  
Punta



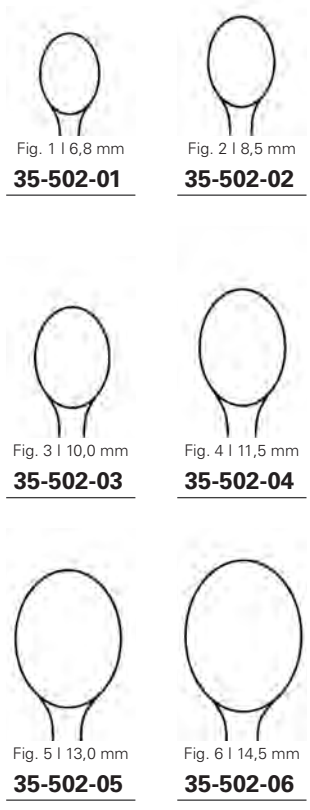
**35-470-01** 20,0 cm, 8 "

Verlängerungsrohr  
Elongation tube  
Tubo de extensión  
Tubi di prolungamento



**35-470-03** SET

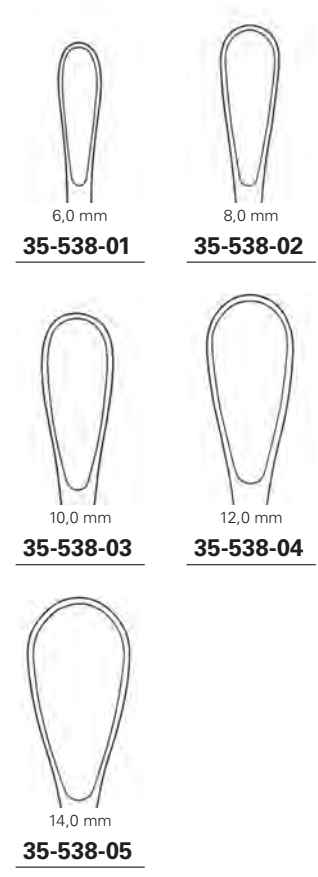
Komplett, 35-470-00, 35-470-01, 35-470-03  
Complete, 35-470-00, 35-470-01, 35-470-03  
Completo, 35-470-00, 35-470-01, 35-470-03  
Completo, 35-470-00, 35-470-01, 35-470-03



scharf, fest  
 sharp, rigid  
 cortantes, rígidas  
 acute, rigide

**SCHROEDER**

**35-502-01 - 35-502-06** 30,0 cm, 11 3/4"



stumpf, fest  
 blunt, rigid  
 romas, rígidas  
 smusse, rigide

**GOURDET**

**35-538-01 - 35-538-05** 28,0 cm, 11"

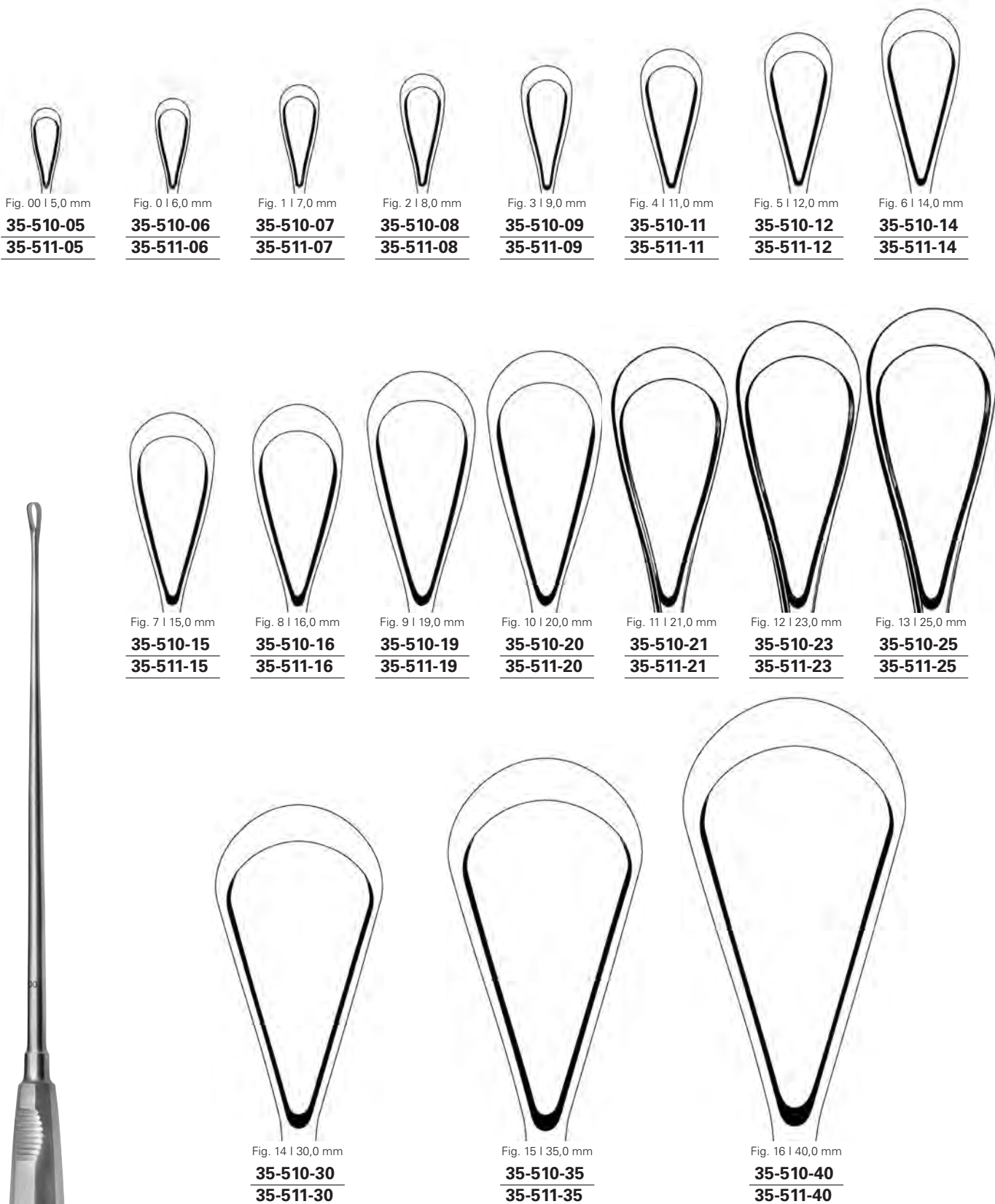


Fig. 00 | 5,0 mm  
**35-510-05**  
**35-511-05**

Fig. 0 | 6,0 mm  
**35-510-06**  
**35-511-06**

Fig. 1 | 7,0 mm  
**35-510-07**  
**35-511-07**

Fig. 2 | 8,0 mm  
**35-510-08**  
**35-511-08**

Fig. 3 | 9,0 mm  
**35-510-09**  
**35-511-09**

Fig. 4 | 11,0 mm  
**35-510-11**  
**35-511-11**

Fig. 5 | 12,0 mm  
**35-510-12**  
**35-511-12**

Fig. 6 | 14,0 mm  
**35-510-14**  
**35-511-14**

Fig. 7 | 15,0 mm  
**35-510-15**  
**35-511-15**

Fig. 8 | 16,0 mm  
**35-510-16**  
**35-511-16**

Fig. 9 | 19,0 mm  
**35-510-19**  
**35-511-19**

Fig. 10 | 20,0 mm  
**35-510-20**  
**35-511-20**

Fig. 11 | 21,0 mm  
**35-510-21**  
**35-511-21**

Fig. 12 | 23,0 mm  
**35-510-23**  
**35-511-23**

Fig. 13 | 25,0 mm  
**35-510-25**  
**35-511-25**

Fig. 14 | 30,0 mm  
**35-510-30**  
**35-511-30**

Fig. 15 | 35,0 mm  
**35-510-35**  
**35-511-35**

Fig. 16 | 40,0 mm  
**35-510-40**  
**35-511-40**

### RECAMIER

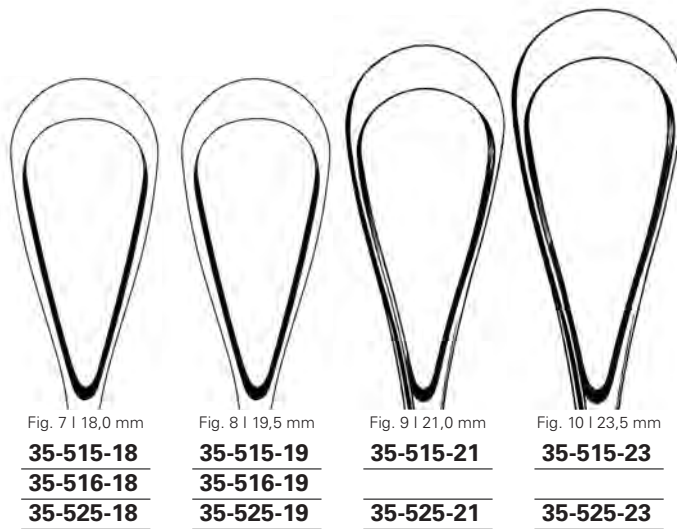
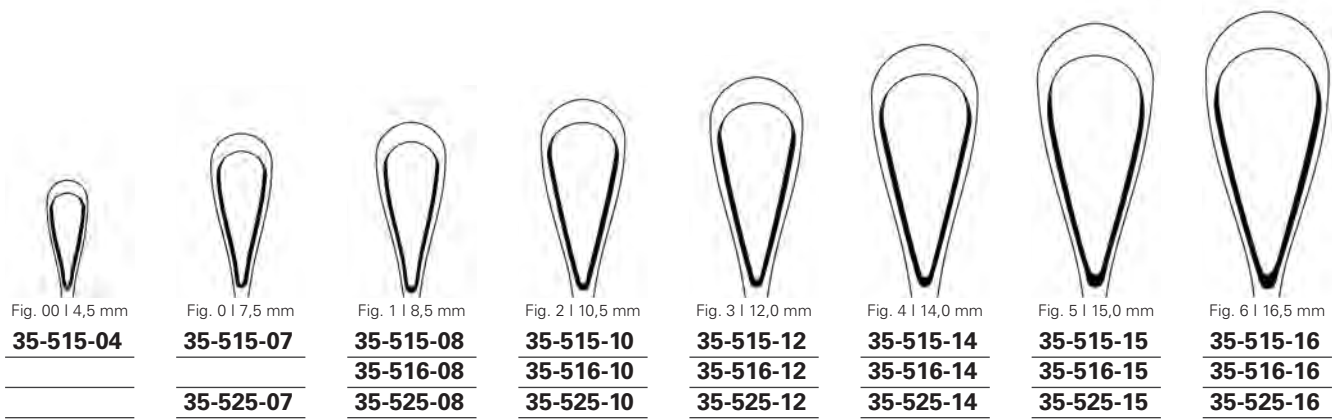
**35-510-05 - 35-510-40** 31,0 cm, 12 ¼"

scharf, fest  
 sharp, rigid  
 cortantes, rígidas  
 acute, rigide

### RECAMIER

**35-511-05 - 35-511-40** 31,0 cm, 12 ¼"

scharf, biegsam  
 sharp, malleable  
 cortantes, maleables  
 acute, malleable



**RECAMIER**

**35-515-04 - 35-515-23** 30,0 cm, 11 3/4"

scharf, fest  
 sharp, rigid  
 cortantes, rígidas  
 acute, rigide

**RECAMIER**

**35-516-08 - 35-516-19** 30,0 cm, 11 3/4"

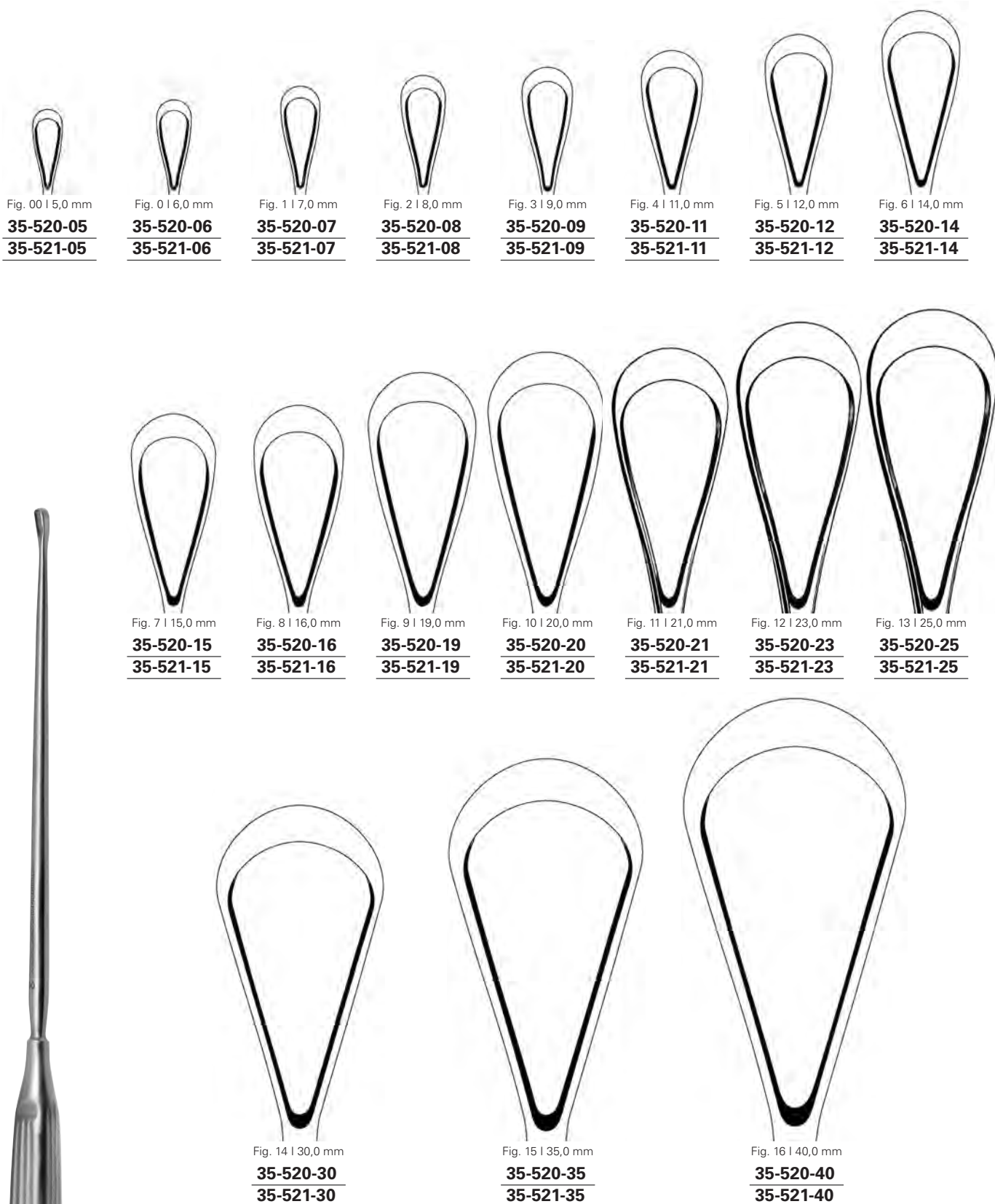
scharf, biegsam  
 sharp, malleable  
 cortantes, maleables  
 acute, malleable

**RECAMIER**

**35-525-07 - 35-525-23** 30,0 cm, 11 3/4"

stumpf, fest  
 blunt, rigid  
 romas, rígidas  
 smusse, rigide





### SIMS

**35-520-05 - 35-520-40** 31,0 cm, 12 1/4"

stumpf, fest  
 blunt, rigid  
 romas, rígidas  
 smusse, rigide

### SIMS

**35-521-05 - 35-521-40** 31,0 cm, 12 1/4"

stumpf, biegsam  
 blunt, malleable  
 romas, maleabeles  
 smusse, malleabile



Fig. 1 | 23,5 mm

**35-516-23**  
**35-526-23**

Fig. 2 | 26,0 mm

**35-516-26**  
**35-526-26**

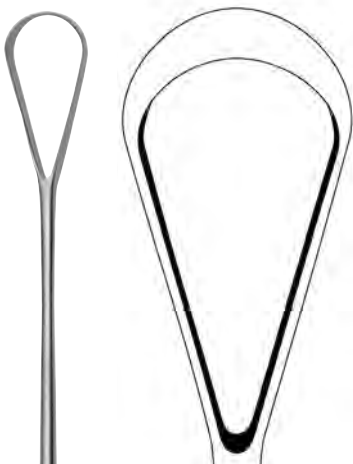


Fig. 3 | 28,5 mm

**35-516-28**  
**35-526-28**

Fig. 1 | 34,5 mm

**35-525-34**

Fig. 2 | 39,5 mm

**35-525-39**



**BUMM**

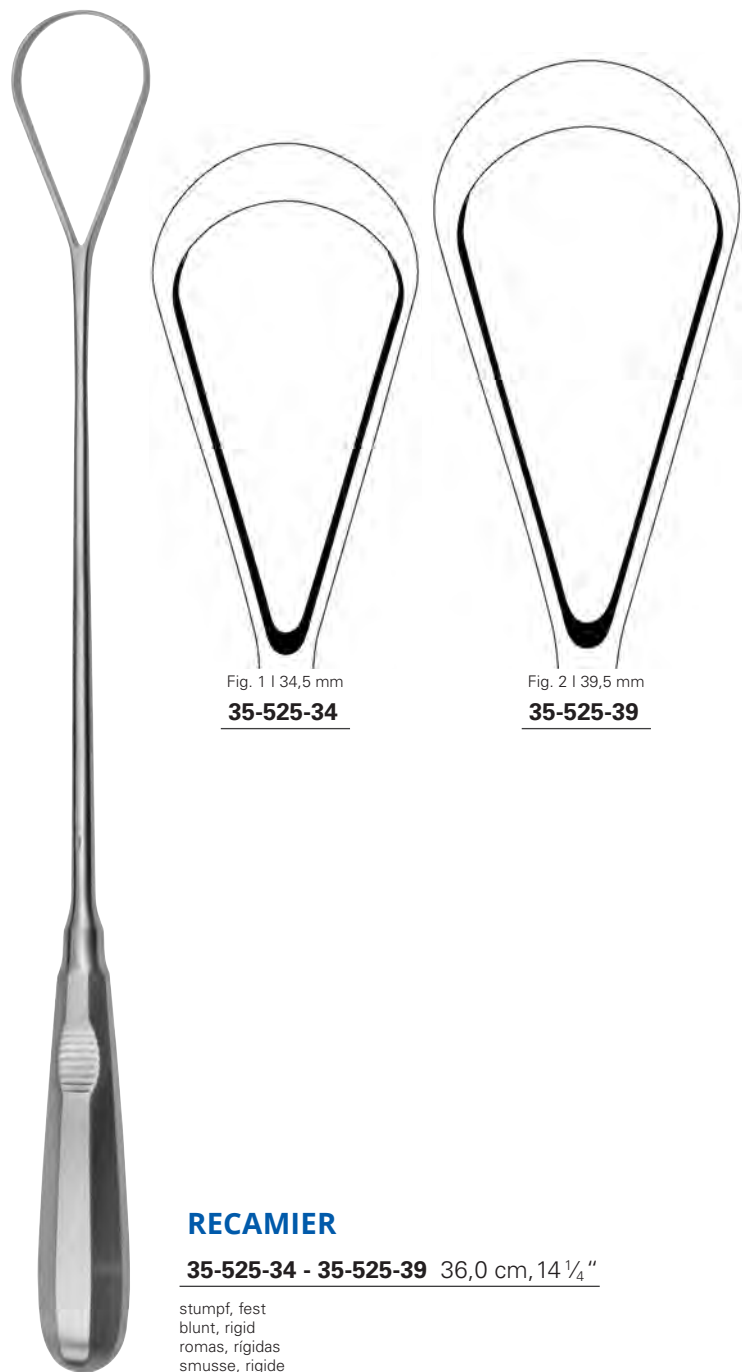
**35-516-23 - 35-516-28** 31,0 cm, 12 ¼"

scharf, biegsam  
 sharp, malleable  
 cortantes, maleabeles  
 acute, malleabile

**BUMM**

**35-526-23 - 35-526-28** 31,0 cm, 12 ¼"

stumpf, biegsam  
 blunt, malleable  
 romas, maleabeles  
 smusse, malleabile



**RECAMIER**

**35-525-34 - 35-525-39** 36,0 cm, 14 ¼"

stumpf, fest  
 blunt, rigid  
 romas, rigidas  
 smusse, rigide



Fig. 01 | 16,0 mm  
**35-527-16**



Fig. 11 | 18,0 mm  
**35-527-18**



Fig. 21 | 19,5 mm  
**35-527-19**



Fig. 31 | 21,5 mm  
**35-527-21**



Fig. 41 | 23,5 mm  
**35-527-23**



Fig. 51 | 26,0 mm  
**35-527-26**



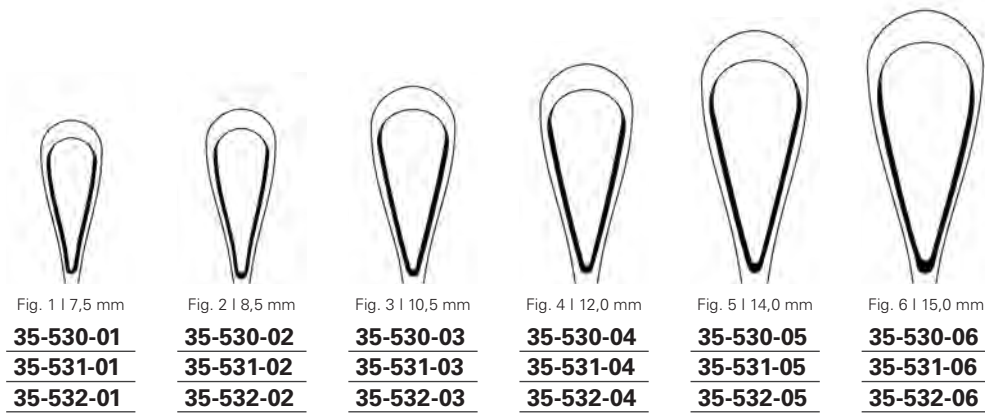
Fig. 61 | 28,5 mm  
**35-527-28**



## BUMM

**35-527-16 - 35-527-28** 29,0 cm, 11 ¼"

stumpf, biegsam  
blunt, malleable  
romas, maleabeles  
smusse, malleabile



**SIMS**

**35-530-01 - 35-530-06** 26,0 cm, 10 1/4"

scharf, fest  
 sharp, rigid  
 cortantes, rígidas  
 acute, rigide

**SIMS**

**35-531-01 - 35-531-06** 26,0 cm, 10 1/4"

scharf, biegsam  
 sharp, malleable  
 cortantes, maleables  
 acute, malleabile

**SIMS**

**35-532-01 - 35-532-06** 26,0 cm, 10 1/4"

stumpf, fest  
 blunt, rigid  
 romas, rígidas  
 smusse, rigide



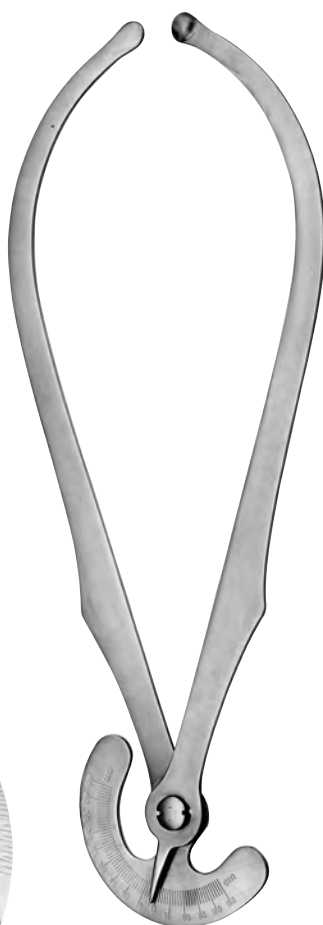
graduiert in cm und Zoll  
graduated in cm and inches  
graduato en cm y pulgadas  
graduato in cm e pollici



### MARTIN

**35-701-34** 34,0 cm, 13 1/3"

graduiert in cm  
graduated in cm  
graduato en cm  
graduato in cm



### COLLIN

**35-703-35** 35,0 cm, 13 3/4"

graduiert in cm und Zoll  
graduated in cm and inches  
graduato en cm y pulgadas  
graduato in cm e pollici



### COLLYER

**35-705-30** 30,0 cm, 11 3/4"



### DE LEE

<b>35-710-30</b>	30,0 cm, 11 3/4"
<b>35-710-36</b>	36,0 cm, 14 1/4"
<b>35-710-39</b>	39,0 cm, 15 1/2"



### NAEGELE

<b>35-711-36</b>	36,0 cm, 14 1/4"
<b>35-711-40</b>	40,0 cm, 16"



### SIMPSON

<b>35-713-23</b>	23,0 cm, 9"
------------------	-------------



**SIMPSON**

**35-713-30** 30,0 cm, 11 <sup>3</sup>/<sub>4</sub>"



**SIMPSON**

**35-713-36** 36,0 cm, 14 <sup>1</sup>/<sub>4</sub>"



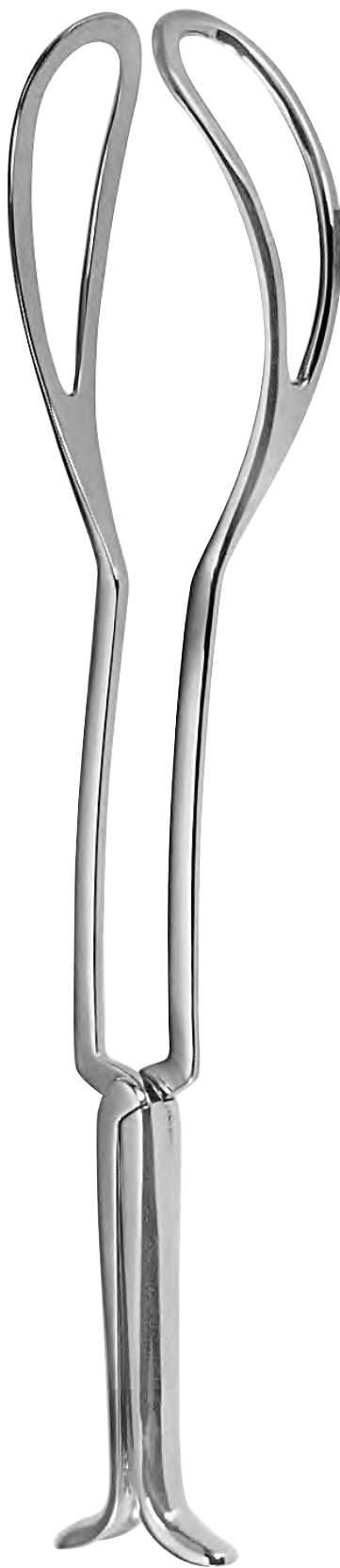
**KIELLAND**

**35-715-41** 41,0 cm, 16"



**SIMPSON-LUIKART**

**35-716-36** 36,0 cm, 14 ¼"



**PIPER**

**35-717-44** 44,0 cm, 17 ½"



**BOERMA**

**35-719-29** 29,0 cm, 11 ½"





### WRIGLEY

**35-721-25** 25,0 cm, 9 3/4 "  
**35-721-29** 28,0 cm, 11 "



### TARNIER

**35-723-40** 40,0 cm, 16 "

Geburtszange mit Achsenzugvorrichtung  
Forceps with traction rod  
Fórceps con dispositivo de tracción  
Forcipi con dispositivo di trazione



Zughebel, passend für alle Geburtszangen mit gehorntem Standard-Griff.  
 Traction handle suitable for all forceps with standard type handle.  
 Tractor adecuado para todas las fórceps con mango standard.  
 Manico a trazione adatto a tutte le forcipi con manico standard.

**BILL**

**35-724-01**

Zangenschloß  
 Traction handle  
 Cierre de la pinza  
 Fermapinza



**LUIKART-BILL**

**35-724-02**



Geburtslöffel  
 Obstetric lever  
 Seperador obstétrica  
 Leva ostetrica

**SELLHEIM**

**35-731-28** 28,0 cm, 11"

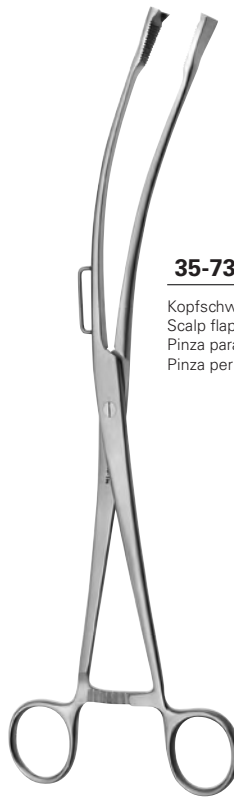


**35-732-21**

Uterusklemmzange zur Blutstillung  
 Caesarean section haemostatic forceps  
 Pinza-clamp uterina para hemostasis  
 Pinza emostatiche per tagli cesarei

**GREEN-ARMYTAGE**

**35-732-21** 21,0 cm, 8 ¼"

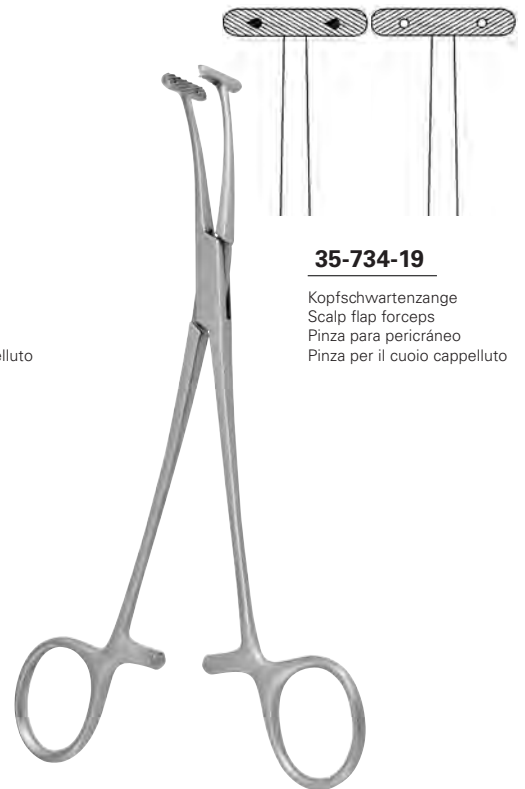


**35-733-27**

Kopfschwartenzange  
 Scalp flap forceps  
 Pinza para pericráneo  
 Pinza per il cuoio cappelluto

**GAUSS**

**35-733-27** 27,0 cm, 10 ¾"



**35-734-19**

Kopfschwartenzange  
 Scalp flap forceps  
 Pinza para pericráneo  
 Pinza per il cuoio cappelluto

**WILLET**

**35-734-19** 19,0 cm, 7 ½"



Dekapitationshaken  
 Decapitating Hooks  
 Ganchos para decapitación  
 Unico per detroncazione

**BRAUN**

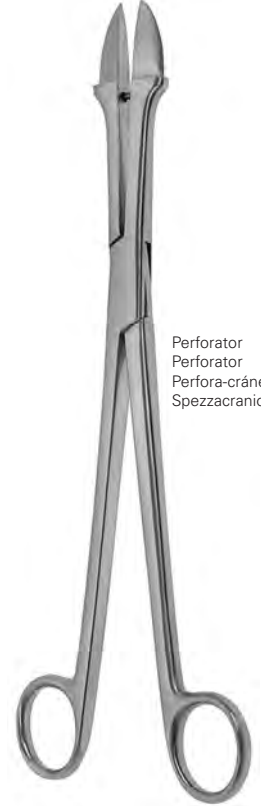
**35-735-30** 30,0 cm, 11 3/4"



Dekapitationshaken  
 Decapitating Hooks  
 Ganchos para decapitación  
 Unico per detroncazione

**SMELLIE**

**35-736-30** 30,0 cm, 11 3/4"



Perforator  
 Perforator  
 Perfora-cráneos  
 Spezzacrani

**SMELLIE**

**35-736-25** 25,0 cm, 9 3/4"



Nabelschnurklemme  
 Umbilical cord clamp  
 Clamp umbilical  
 Clamp ombelicale

**COLLIN**

**35-737-09** 9,0 cm, 3 1/2"



Nabelschnurklemme  
 Umbilical cord clamp  
 Clamp umbilical  
 Clamp ombelicale

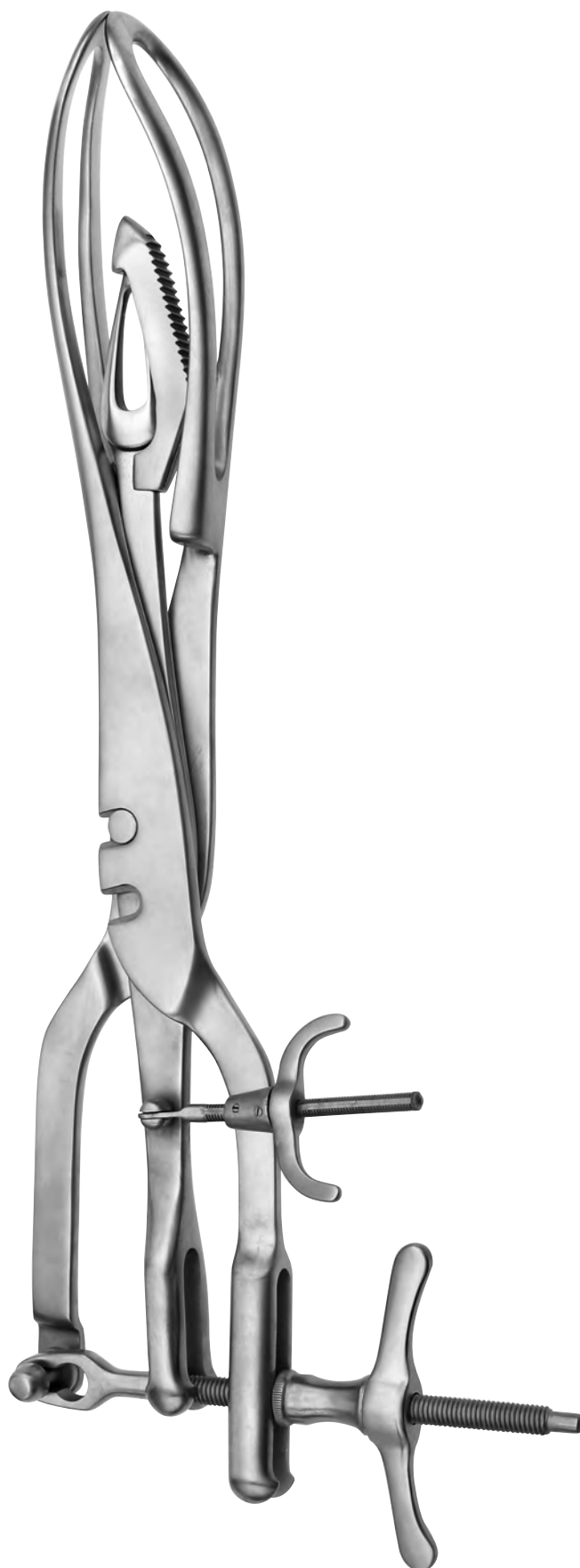
**KANE**

**35-739-09** 8,5 cm, 3 1/3"



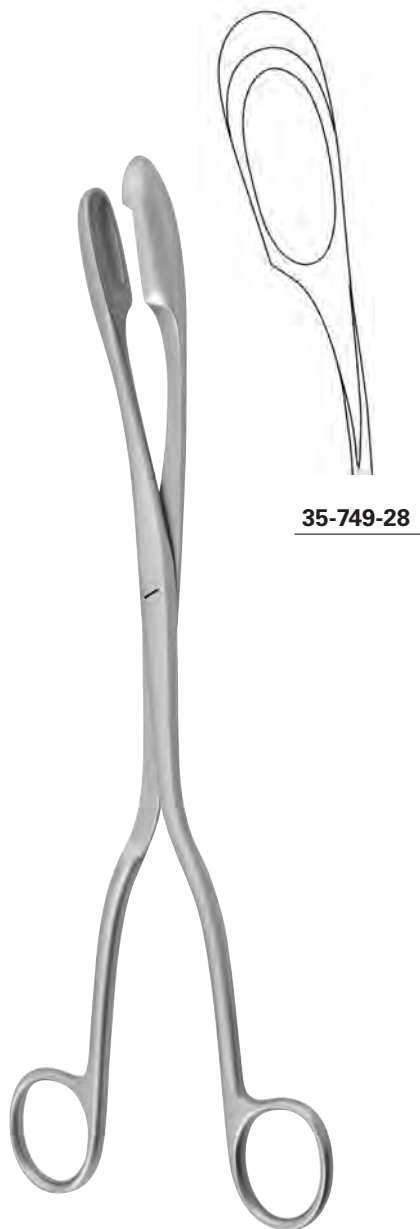
**BRAUN**

**35-738-42** 42,0 cm, 16 1/2"



**TARNIER**

**35-738-46** 44,0 cm, 18"



**35-749-28**

**WINTER**

**35-749-28** 28,5 cm, 11 1/4"



Fig. 1  
**35-750-01**

Fig. 2  
**35-750-02**

Fig. 3  
**35-750-03**

Fig. 1  
**35-751-01**

Fig. 2  
**35-751-02**

Fig. 3  
**35-751-03**

**WINTER**

**35-750-01 - 35-751-03** 28,0 cm, 11"



**WINTER**

**35-751-12 - 35-751-13** 29,0 cm, 11 ¼"



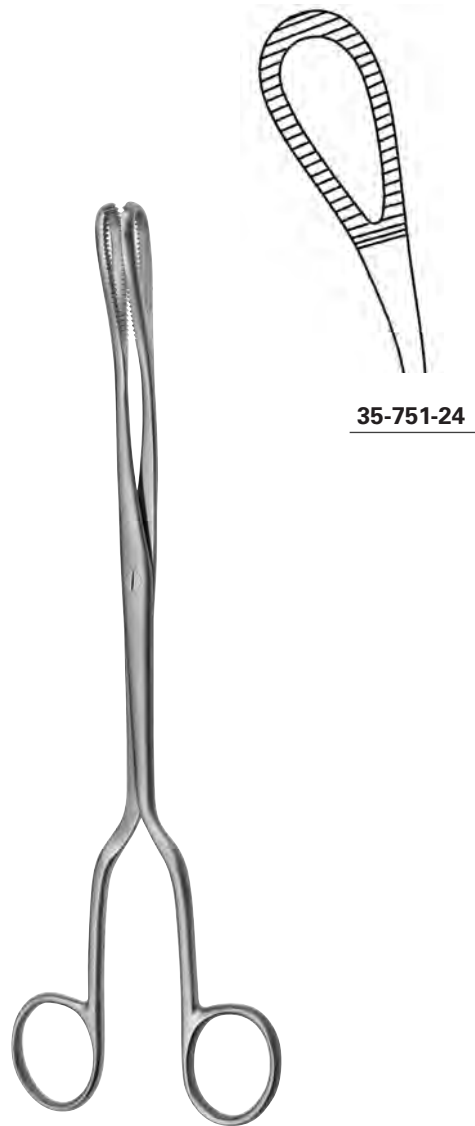
Fig. 2

**35-751-12**



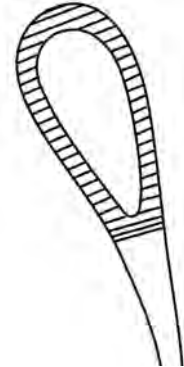
Fig. 3

**35-751-13**



**MC CLINTOCK**

**35-751-24** 24,0 cm, 9 ½"



**35-751-24**



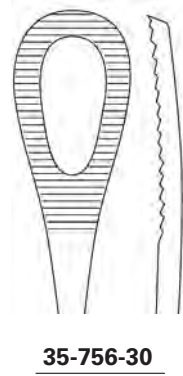
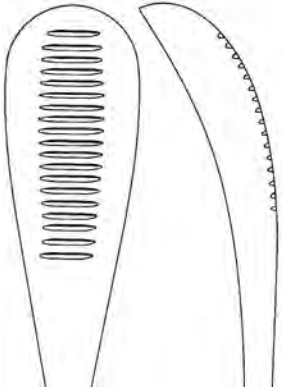
**SAENGER**

**35-752-27** 27,0 cm, 10 $\frac{3}{4}$ "



**SAENGER**

**35-753-27** 27,0 cm, 10 $\frac{3}{4}$ "



**CUZZI**

**35-754-14 - 35-754-20** 30,0 cm, 11 3/4"

**PESTALOZZA**

**35-756-30** 30,0 cm, 11 3/4"



36

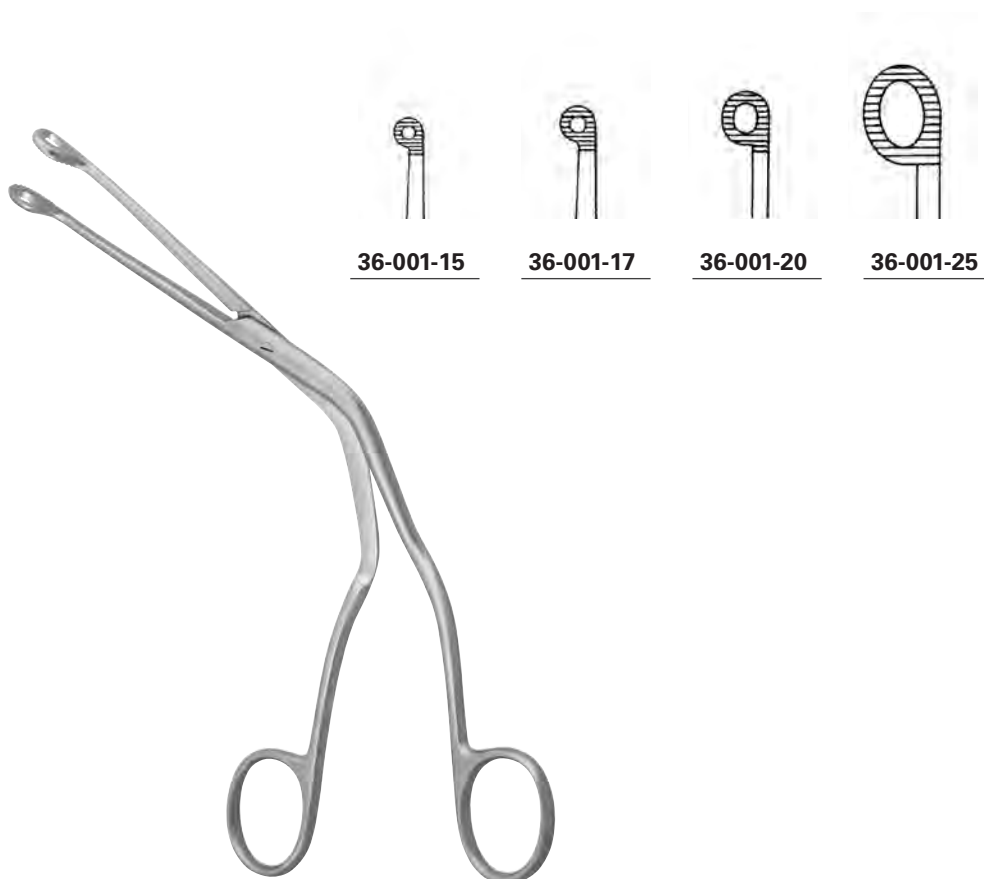
Urologie

Urology

Urología

Urologia





**36-001-15**

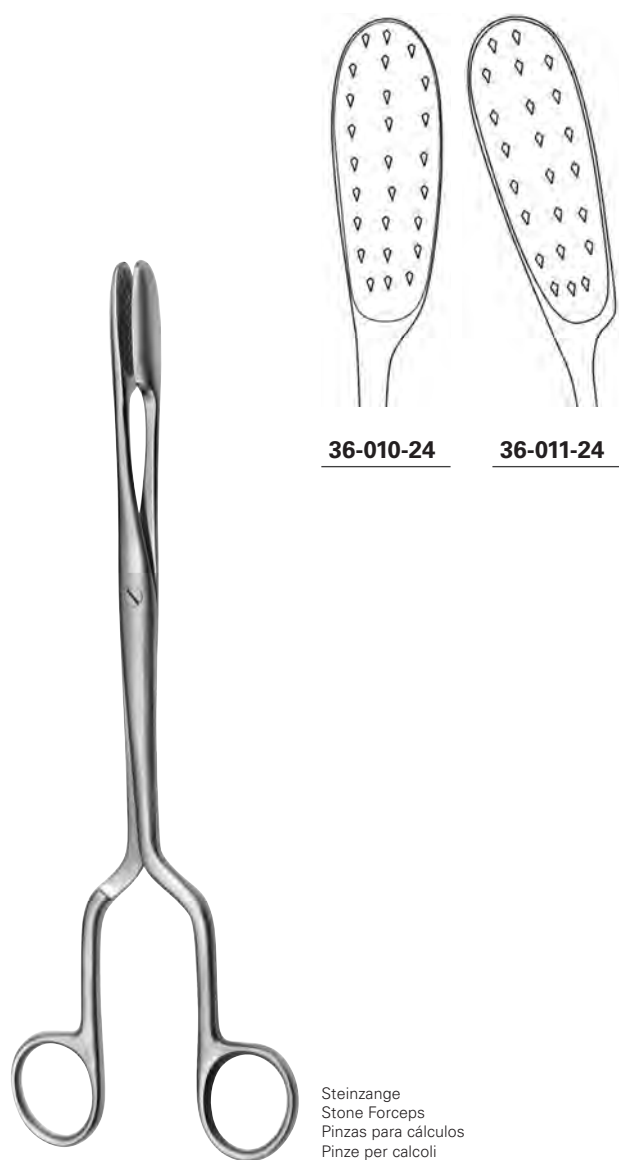
**36-001-17**

**36-001-20**

**36-001-25**

**MAGILL**

<b>36-001-15</b>	15,0 cm, 6 "
<b>36-001-17</b>	17,0 cm, 6 <sup>3</sup> / <sub>4</sub> "
<b>36-001-20</b>	20,0 cm, 8 "
<b>36-001-25</b>	25,0 cm, 9 <sup>3</sup> / <sub>4</sub> "



**36-010-24**

**36-011-24**

Steinzange  
Stone Forceps  
Pinzas para cálculos  
Pinze per calcoli

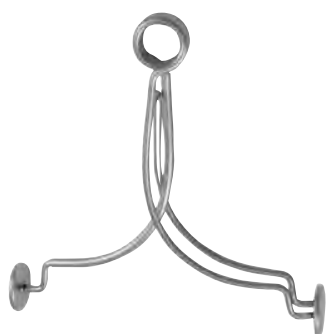


Ureterzange  
Urethro Forceps  
Pinzas para uréter  
Pinze per uretere

## LEWKOWITZ

**36-010-24 - 36-011-24** 24,0 cm, 9 2/3 "

**36-012-24** 24,0 cm, 9 2/3 "



**STOCKMANN**

**36-050-08** 8,0 cm, 3 1/8"



**STRAUSS**

**36-060-11** 11,0 cm, 4 3/8"



Ø 4,8 mm

**36-062-12**



**STOCKMANN**

**36-062-12** 12,5 cm, 5"



**36-064-14** 14,5 cm, 5 3/4"



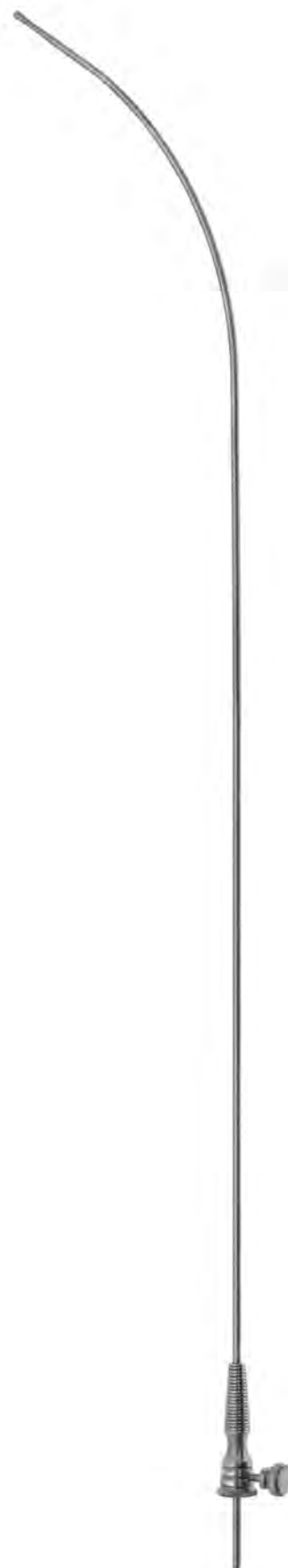
**GUYON**

**36-070-39** 39,0 cm, 15 1/2"



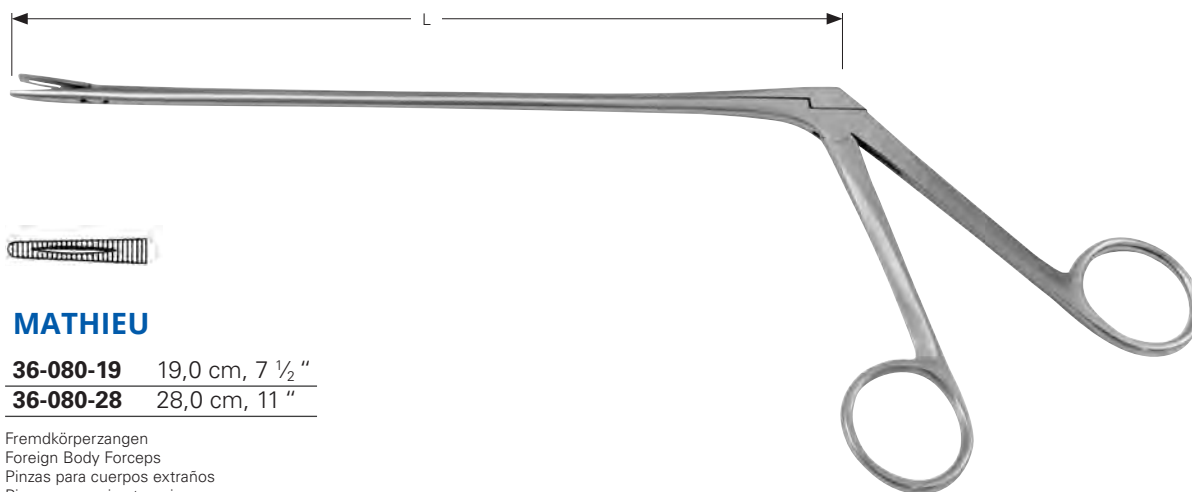
**GUYON**

**36-071-35** 35,0 cm, 13 3/4"



**DITTEL**

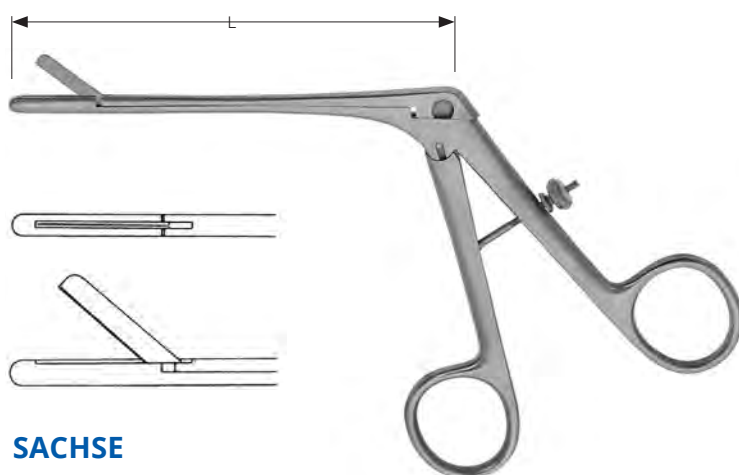
**36-071-46** 46,0 cm, 18"



**MATHIEU**

<b>36-080-19</b>	19,0 cm, 7 1/2"
<b>36-080-28</b>	28,0 cm, 11"

Fremdkörperzangen  
 Foreign Body Forceps  
 Pinzas para cuerpos extraños  
 Pinze per corpi estranei



**SACHSE**

<b>36-082-12</b>	12,5 cm, 4 3/4"
------------------	-----------------

Meatotom  
 Meatotome  
 Meatótomo  
 Meatotomo



## GUYON

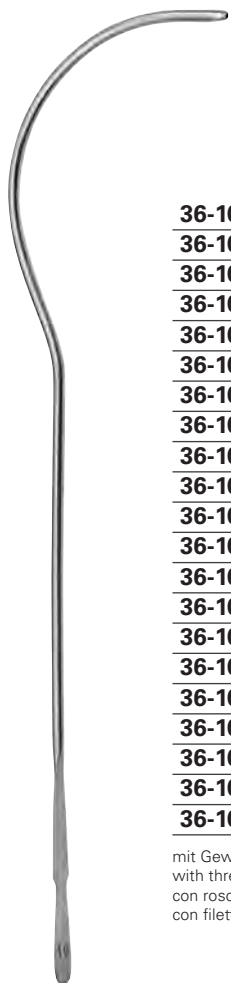
### 36-100-00 SET

Satz mit 21 Bougies, Charr. 10 bis 30,  
 mit 4 Gleitsonden, im Metalltui  
 42,0 x 17,5 x 4,0 cm

Set with 21 bougies, Charr. 10 to 30,  
 with 4 filiform bougies, in metal case  
 42,0 x 17,5 x 4,0 cm

Juego de 21 bujías, Charr. 10 a 30,  
 con 4 bujías filiformes, en caja metálica  
 42,0 x 17,5 x 4,0 cm

Set di 21 dilatatori, Charr. 10 fino a 30,  
 con 4 candelette dilatatrici, in contenitore  
 metallico 42,0 x 17,5 x 4,0 cm



<b>36-100-10</b>	10 Charr.
<b>36-100-11</b>	11 Charr.
<b>36-100-12</b>	12 Charr.
<b>36-100-13</b>	13 Charr.
<b>36-100-14</b>	14 Charr.
<b>36-100-15</b>	15 Charr.
<b>36-100-16</b>	16 Charr.
<b>36-100-17</b>	17 Charr.
<b>36-100-18</b>	18 Charr.
<b>36-100-19</b>	19 Charr.
<b>36-100-20</b>	20 Charr.
<b>36-100-21</b>	21 Charr.
<b>36-100-22</b>	22 Charr.
<b>36-100-23</b>	23 Charr.
<b>36-100-24</b>	24 Charr.
<b>36-100-25</b>	25 Charr.
<b>36-100-26</b>	26 Charr.
<b>36-100-27</b>	27 Charr.
<b>36-100-28</b>	28 Charr.
<b>36-100-29</b>	29 Charr.
<b>36-100-30</b>	30 Charr.

mit Gewinde  
 with thread  
 con rosca  
 con filetto

## GUYON

**36-100-10 - 36-100-30** 26,0 cm, 10 1/4"



Verpackungseinheit: 5 St.  
 Packing unit: 5 pieces  
 Unidad: 5 piezas  
 Confezione: 5 pezzi

<b>36-101-03</b>	3 Charr.
<b>36-101-04</b>	4 Charr.
<b>36-101-05</b>	5 Charr.
<b>36-101-06</b>	6 Charr.

mit Schraubgewinde-Ansatz  
 with screw thread  
 con rosca de tornillo  
 con attacco filettato

## FILIFORM

**36-101-03 - 36-101-06**



### VAN BUREN

#### 36-102-00 SET

Satz mit 26 Bougies, Charr. 8 bis 36  
Set with 26 bougies, Charr. 8 to 36  
Juego de 26 bujías, Charr. 8 a 36  
Set di 26 dilatatori, Charr. 8 fino a 36

<b>36-102-08</b>	8 Charr.
<b>36-102-09</b>	9 Charr.
<b>36-102-10</b>	10 Charr.
<b>36-102-11</b>	11 Charr.
<b>36-102-12</b>	12 Charr.
<b>36-102-13</b>	13 Charr.
<b>36-102-14</b>	14 Charr.
<b>36-102-15</b>	15 Charr.
<b>36-102-16</b>	16 Charr.
<b>36-102-17</b>	17 Charr.
<b>36-102-18</b>	18 Charr.
<b>36-102-19</b>	19 Charr.
<b>36-102-20</b>	20 Charr.
<b>36-102-21</b>	21 Charr.
<b>36-102-22</b>	22 Charr.
<b>36-102-23</b>	23 Charr.
<b>36-102-24</b>	24 Charr.
<b>36-102-25</b>	25 Charr.
<b>36-102-26</b>	26 Charr.
<b>36-102-27</b>	27 Charr.
<b>36-102-28</b>	28 Charr.
<b>36-102-29</b>	29 Charr.
<b>36-102-30</b>	30 Charr.
<b>36-102-32</b>	32 Charr.
<b>36-102-34</b>	34 Charr.
<b>36-102-36</b>	36 Charr.

### VAN BUREN

**36-102-08 - 36-102-36** 27,5 cm, 10¾"



<b>36-104-00</b>	0   2 E.G.
<b>36-104-01</b>	1 E.G.
<b>36-104-02</b>	½   3 E.G.
<b>36-104-03</b>	1   4 E.G.
<b>36-104-04</b>	2   5 E.G.
<b>36-104-05</b>	3   6 E.G.
<b>36-104-06</b>	4   7 E.G.
<b>36-104-07</b>	5   8 E.G.
<b>36-104-08</b>	6   9 E.G.
<b>36-104-09</b>	7   10 E.G.
<b>36-104-10</b>	8   11 E.G.
<b>36-104-11</b>	9   12 E.G.
<b>36-104-12</b>	10   13 E.G.
<b>36-104-13</b>	11   14 E.G.
<b>36-104-14</b>	12   15 E.G.
<b>36-104-15</b>	13   16 E.G.
<b>36-104-16</b>	14   17 E.G.
<b>36-104-17</b>	15   18 E.G.

### LISTER

**36-104-00 - 36-104-17** 28,0 cm, 10¾"





<b>36-110-06</b>	6 Charr.
<b>36-110-07</b>	7 Charr.
<b>36-110-08</b>	8 Charr.
<b>36-110-09</b>	9 Charr.
<b>36-110-10</b>	10 Charr.
<b>36-110-11</b>	11 Charr.
<b>36-110-12</b>	12 Charr.
<b>36-110-13</b>	13 Charr.
<b>36-110-14</b>	14 Charr.
<b>36-110-16</b>	16 Charr.
<b>36-110-18</b>	18 Charr.
<b>36-110-20</b>	20 Charr.
<b>36-110-22</b>	22 Charr.
<b>36-110-24</b>	24 Charr.

für Frauen  
for women  
para mujeres  
per donne



<b>36-112-08</b>	8 Charr.
<b>36-112-10</b>	10 Charr.
<b>36-112-12</b>	12 Charr.
<b>36-112-14</b>	14 Charr.
<b>36-112-16</b>	16 Charr.
<b>36-112-18</b>	18 Charr.
<b>36-112-20</b>	20 Charr.

für Männer  
for men  
para hombres  
per uomini

**36-110-06 - 36-110-24** 15,0 cm, 6 "

**36-112-08 - 36-112-20** 25,0 cm, 10 "



**LEGUEU**

**36-617-00** SET

**LEGUEU**

**36-617-01**

Blasenwundspreizer, allein  
Bladder retractor, only  
Separadores para la vejiga, sola  
Divaricatori vescicali, sola

**LEGUEU**

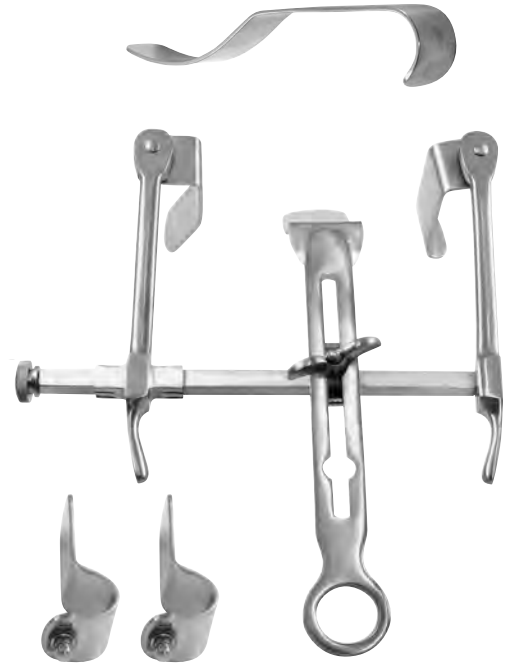
**36-617-10** 30 x 85 mm

Mittelvalve, allein  
Central blade, only  
Valva central, sola  
Valva centrale, sola

**LEGUEU**

**36-617-11** 30 x 63 mm

Seitenvalven Paar, allein  
Lateral blades pair, only  
Valvas laterales par, sola  
Valve laterali paio, sola



**THOMSON-WALKER**

**36-618-00** SET



**MILLIN**

**36-620-00** SET

**MILLIN**

**36-620-01**

Blasenwundspreizer, allein  
Bladder retractor, only  
Separadores para la vejiga, sola  
Divaricatori vescicali, sola

**MILLIN**

**36-620-02** 110 x 45 mm

Mittelvalve, allein  
Central blade, only  
Valva central, sola  
Valva centrale, sola

**MILLIN**

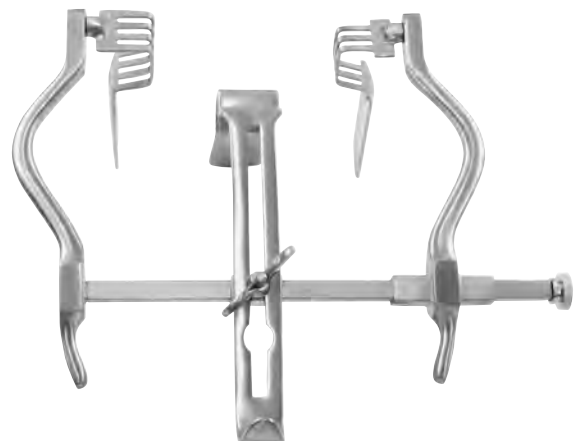
**36-620-03** 57 x 25 mm

**36-620-04** 80 x 25 mm

Seitenvalven Paar, allein  
Lateral blades pair, only  
Valvas laterales par, sola  
Valve laterali paio, sola

Seitenvalven 25 x 70 mm  
Lateral blades 25 x 70 mm  
Valvas laterales 25 x 70 mm  
Valve laterali 25 x 70 mm

Mittelvalve 24 x 84 mm  
Central blade 24 x 84 mm  
Valva central 24 x 84 mm  
Valva centrale 24 x 84 mm



**JUDD-MASSON**

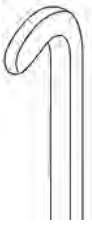
**36-619-00** SET



Blasenspatel  
 Bladder spatula  
 Espátulas para la vesícula  
 Spatole vescicali

**LEGUEU**

**36-621-27** 27,0 cm, 10 3/4"



**36-621-27**

Blasenhalsspreizer  
 Bladder neck spreader  
 Dilatador para el cuello vesical  
 Dilatatore per collo vescicale

**MILLIN**

**36-622-00** 28,0 cm, 11"



67,0 mm

Blasenspatel  
 Bladder spatula  
 Espátulas para la vesícula  
 Spatole vescicali

**KOCHER**

**36-625-26** 26,0 cm, 10 1/4"



36,0 x 13,0 mm

**36-623-01**

lateral  
 lateral  
 lateral  
 laterale

**YOUNG**

**36-623-01** 22,0 cm, 8 3/4"



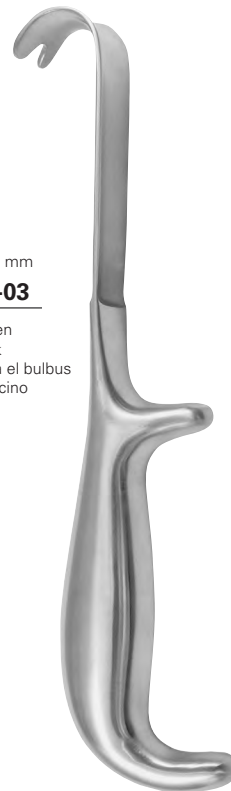
68,0 x 38,0 mm

**36-623-02**

anterior  
 anterior  
 anterior  
 anteriore

**YOUNG**

**36-623-02** 22,0 cm, 8 3/4"



23,0 x 25,0 mm

**36-623-03**

Bulbus-Haken  
 Bulbus hook  
 Gancho para el bulbus  
 Bulbo ad uncino

**YOUNG**

**36-623-03** 22,0 cm, 8 3/4"



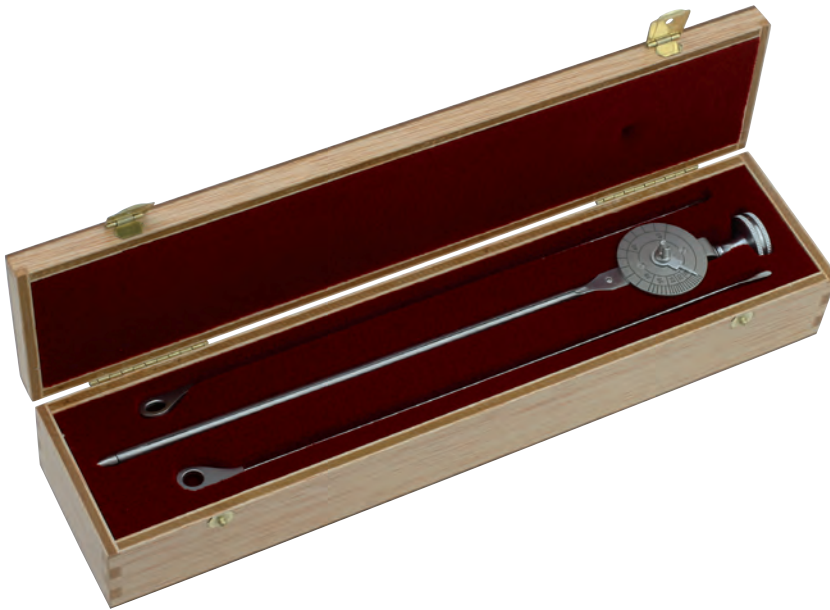
36,0 x 38,0 mm

**36-623-04**

gegabelt  
 forked  
 horquilla  
 a forchetta

**YOUNG**

**36-623-04** 22,0 cm, 8 3/4"



**OTIS**

**36-630-00** SET

Komplett in Holzetui,  
bestehend aus:

1 Dilatator	<b>36-630-01</b>
2 Messer	<b>36-630-02</b>
1 Ansatz, konisch	<b>36-630-03</b>
1 Ansatz, flach	<b>36-630-04</b>
1 Ansatz, Kugel	<b>36-630-05</b>

Completo en estuche de madera,  
compuesto de:

1 Dilatador	<b>36-630-01</b>
2 Cuchillos	<b>36-630-02</b>
1 Terminal, cónico	<b>36-630-03</b>
1 Terminal, plano	<b>36-630-04</b>
1 Terminal, esférico	<b>36-630-05</b>

Complete in wooden case,  
consisting of:

1 Dilator	<b>36-630-01</b>
2 Knives	<b>36-630-02</b>
1 Tip, conical	<b>36-630-03</b>
1 Tip, flat	<b>36-630-04</b>
1 Tip, ball	<b>36-630-05</b>

Completo in astuccio di legno,  
composto da:

1 Dilatore	<b>36-630-01</b>
2 Coltelli	<b>36-630-02</b>
1 Terminale, conico	<b>36-630-03</b>
1 Terminale, piatto	<b>36-630-04</b>
1 Terminale, sferico	<b>36-630-05</b>



**36-630-03**

Ansatz, konisch  
Tip, conical  
Terminal, cónico  
Terminale, conico



**36-630-04**

Ansatz, flach  
Tip, flat  
Terminal, plano  
Terminale, piatto



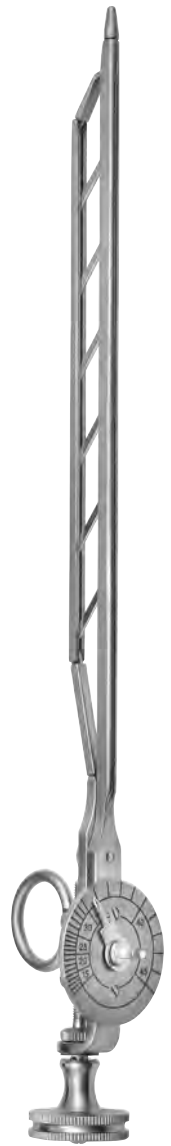
**36-630-05**

Ansatz, Kugel  
Tip, ball  
Terminal, esférico  
Terminale, sferico



**36-630-02**

Messer  
Knife  
Cuchillo  
Coltello



**36-630-01**

Dilatator  
Dilator  
Dilatador  
Dilatatore

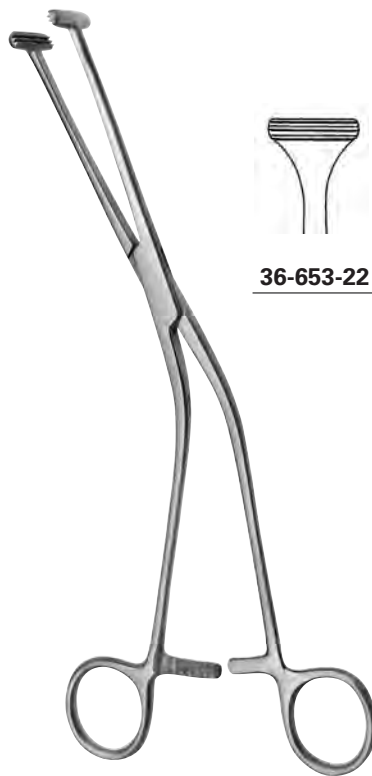


**36-651-24**



**MILLIN**

**36-651-24** 24,0 cm, 9 1/2"



**36-653-22**

**MILLIN**

**36-653-22** 22,0 cm, 8 3/4"



**36-655-23**

**MILLIN**

**36-655-23** 24,0 cm, 9 1/2"

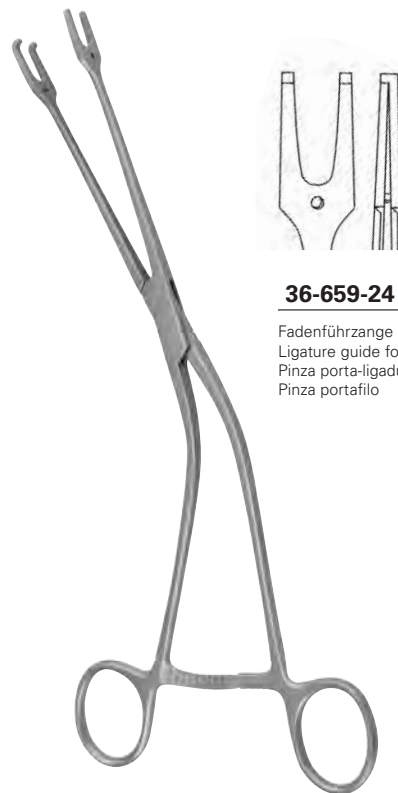


**36-657-23**

9 x 9 Zähne  
 9 x 9 teeth  
 9 x 9 dientes  
 9 x 9 denti

**MILLIN**

**36-657-23** 23,0 cm, 9"



**36-659-24**

Fadenführzange  
 Ligature guide forceps  
 Pinza porta-ligaduras supra-pubiana  
 Pinza portafilo

**MILLIN**

**36-659-24** 24,0 cm, 9 1/2"



**36-765-08** Ø 8,0 mm

für Säuglinge  
for infants  
para bebés  
per neonati

**36-765-11** Ø 11,0 mm

**36-765-13** Ø 13,0 mm

für Knaben  
for boys  
para niños  
per bambini

**36-765-14** Ø 14,5 mm

**36-765-16** Ø 16,0 mm

**36-765-21** Ø 21,0 mm

für Jugendliche  
for teenager  
para adolescentes  
per adolescenti

**36-765-26** Ø 26,0 mm

**36-765-32** Ø 32,0 mm

für Männer  
for men  
para hombres  
per uomini

40

Knochenchirurgie

Bone Surgery

Cirurgía ósea

Chirurgia ossea





1,0 mm  
**40-000-15**

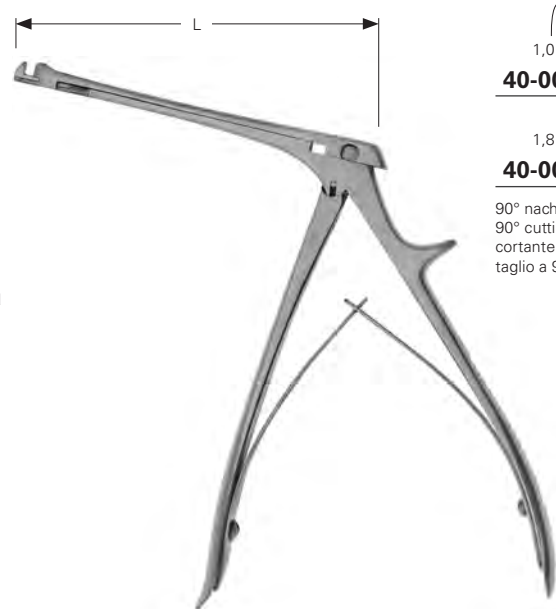
2,0 mm  
**40-000-22**

3,0 mm  
**40-000-30**

90° nach oben schneidend  
90° cutting upwards  
cortante hacia arriba 90°  
taglio a 90° verso l'alto

**CITELLI**

**40-000-15 - 40-000-30** 6,5 cm, 2 1/2"



1,0 mm  
**40-002-10**

1,8 mm  
**40-002-18**

90° nach oben schneidend  
90° cutting upwards  
cortante hacia arriba 90°  
taglio a 90° verso l'alto

**CITELLI-BEYER**

**40-002-10 - 40-002-18** 9,5 cm, 3 3/4"



3,0 mm  
**40-004-03**

4,0 mm  
**40-004-04**

5,0 mm  
**40-004-05**

6,0 mm  
**40-004-06**

90° nach oben schneidend  
90° cutting upwards  
cortante hacia arriba 90°  
taglio a 90° verso l'alto

**KERRISON**

**40-004-03 - 40-004-06** 9,0 cm, 3 1/2"



3,0 mm  
**40-005-20**

**HAJEK-CLAUS**

**40-005-20** 20,0 cm, 8"

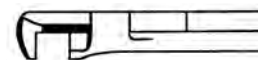




**40-006-33** 3,3 mm

**40-006-40** 4,0 mm

90° nach oben schneidend  
 90° cutting upwards  
 cortante hacia arriba 90°  
 taglio a 90° verso l'alto



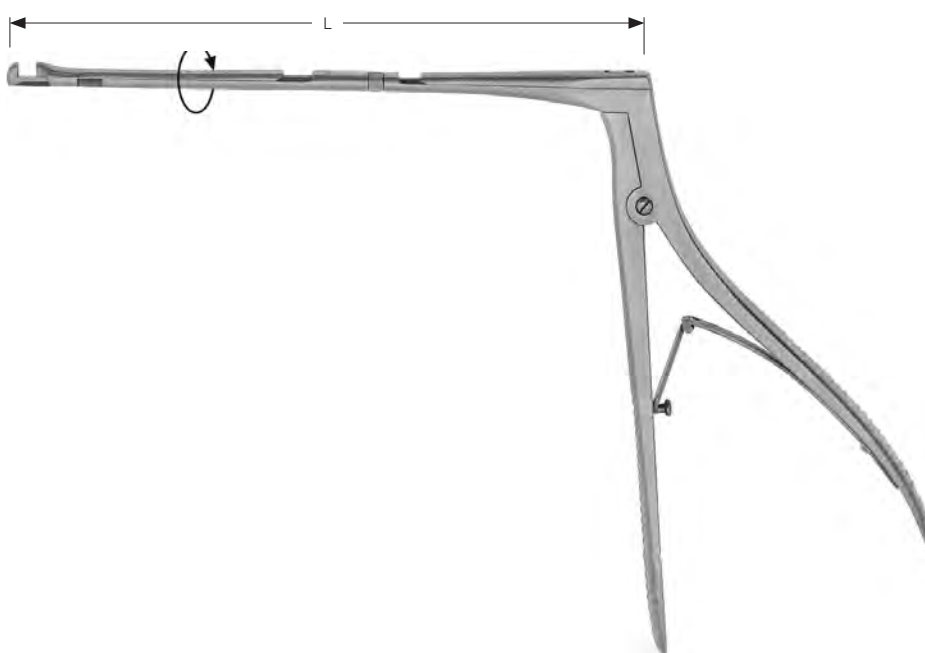
**40-007-33** 3,3 mm

**40-007-40** 4,0 mm

90° nach unten schneidend  
 90° cutting downwards  
 cortante hacia abajo 90°  
 taglio a 90° verso il basso

## HAJEK-KOFLER

**40-006-33 - 40-007-40** 14,0 cm, 5 1/2"

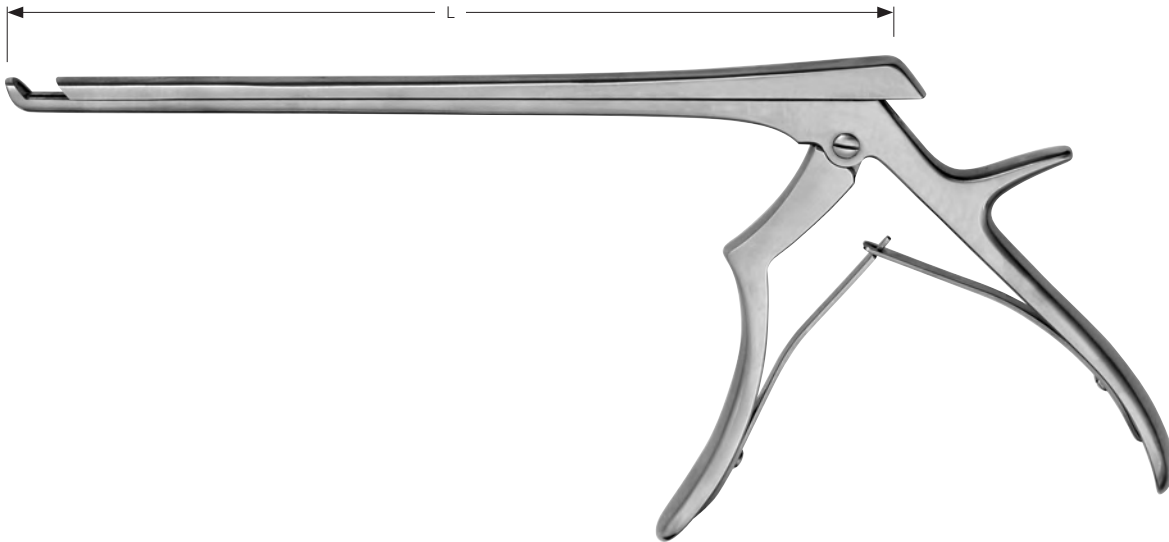


**40-009-40** 3,5 mm

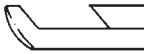
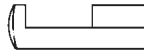
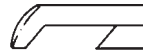
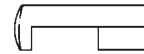
90° schneidend, Schaft 360° drehbar  
 90° cutting, shaft rotatable 360°  
 corte 90°, vástago girable 360°  
 taglio a 90°, albero rotante di 360°

## HAJEK-KOFLER

**40-009-40** 17,0 cm, 6 3/4"



## FERRIS-SMITH-KERRISON

	L				
Bissbreite	Schaftlänge	40° nach oben	90° nach oben	40° nach unten	90° nach unten
Width of bite	Length of shaft	40° upwards	90° upwards	40° downwards	90° downwards
Ancura de la boca	Longitud del vástago	40° hacia arriba	90° hacia arriba	40° hacia abajo	90° hacia abajo
Larghezza del morso	Lunghezza dell'asta	40° verso l'alto	90° verso l'alto	40° verso il basso	90° il basso
1,0 mm	180 mm, 7"	<b>40-014-01</b>	<b>40-016-01</b>	<b>40-017-01</b>	<b>40-019-01</b>
2,0 mm	180 mm, 7"	<b>40-014-02</b>	<b>40-016-02</b>	<b>40-017-02</b>	<b>40-019-02</b>
3,0 mm	180 mm, 7"	<b>40-014-03</b>	<b>40-016-03</b>	<b>40-017-03</b>	<b>40-019-03</b>
4,0 mm	180 mm, 7"	<b>40-014-04</b>	<b>40-016-04</b>	<b>40-017-04</b>	<b>40-019-04</b>
5,0 mm	180 mm, 7"	<b>40-014-05</b>	<b>40-016-05</b>	<b>40-017-05</b>	<b>40-019-05</b>
6,0 mm	180 mm, 7"	<b>40-014-06</b>	<b>40-016-06</b>	<b>40-017-06</b>	<b>40-019-06</b>
1,0 mm	200 mm, 8"	<b>40-014-11</b>	<b>40-016-11</b>	<b>40-017-11</b>	<b>40-019-11</b>
2,0 mm	200 mm, 8"	<b>40-014-12</b>	<b>40-016-12</b>	<b>40-017-12</b>	<b>40-019-12</b>
3,0 mm	200 mm, 8"	<b>40-014-13</b>	<b>40-016-13</b>	<b>40-017-13</b>	<b>40-019-13</b>
4,0 mm	200 mm, 8"	<b>40-014-14</b>	<b>40-016-14</b>	<b>40-017-14</b>	<b>40-019-14</b>
5,0 mm	200 mm, 8"	<b>40-014-15</b>	<b>40-016-15</b>	<b>40-017-15</b>	<b>40-019-15</b>
6,0 mm	200 mm, 8"	<b>40-014-16</b>	<b>40-016-16</b>	<b>40-017-16</b>	<b>40-019-16</b>
1,0 mm	230 mm, 9"	<b>40-014-21</b>	<b>40-016-21</b>	<b>40-017-21</b>	<b>40-019-21</b>
2,0 mm	230 mm, 9"	<b>40-014-22</b>	<b>40-016-22</b>	<b>40-017-22</b>	<b>40-019-22</b>
3,0 mm	230 mm, 9"	<b>40-014-23</b>	<b>40-016-23</b>	<b>40-017-23</b>	<b>40-019-23</b>
4,0 mm	230 mm, 9"	<b>40-014-24</b>	<b>40-016-24</b>	<b>40-017-24</b>	<b>40-019-24</b>
5,0 mm	230 mm, 9"	<b>40-014-25</b>	<b>40-016-25</b>	<b>40-017-25</b>	<b>40-019-25</b>
6,0 mm	230 mm, 9"	<b>40-014-26</b>	<b>40-016-26</b>	<b>40-017-26</b>	<b>40-019-26</b>

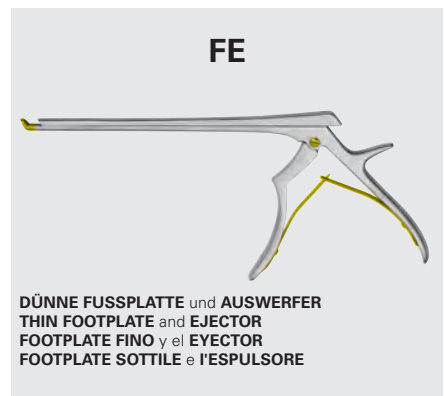
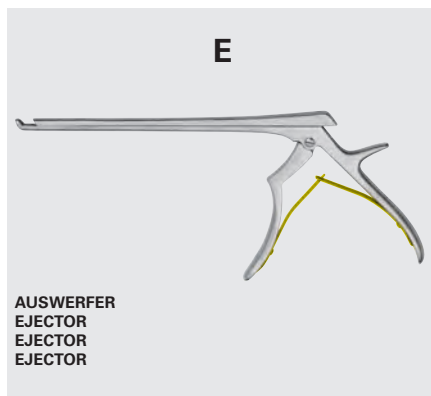
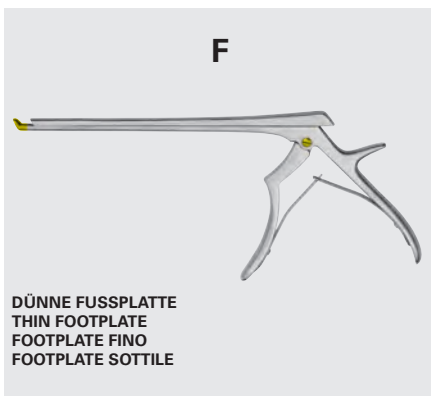
Weitere Längen auf Anfrage  
Other lengths on request  
Otras longitudes bajo pedido  
Ulteriori lunghezze su richiesta



STEEL  
 STAINLESS

STEEL  
 STAINLESS

STEEL  
 STAINLESS



Für **AUSWERFER** fügen Sie ein "E" hinter die Artikelnummer (nicht möglich für 1 & 2 mm Stanzen)  
 For **EJECTOR** please add "E" behind the item number (not available for 1 & 2 mm punches)  
 Para el **EJECTOR** agregue por favor "E" detrás del número del artículo (no disponible para los sacadores de 1 y 2 mm)  
 Per **EJECTOR** aggiunga prego la "E" dietro il numero dell'articolo (non disponibile per i punzoni da 1 & 2 mm)



Für **DÜNNE FUSSPLATTE** fügen Sie ein "F" hinter die Artikelnummer  
 For **THIN FOOTPLATE** please add "F" behind the item number  
 Para el **FOOTPLATE FINO** agregue por favor "F" detrás del número del artículo  
 Per **FOOTPLATE SOTTILE** aggiunga prego la "F" dietro il numero dell'articolo



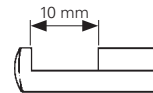
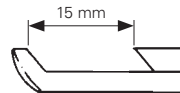
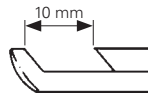
Für **DÜNNE FUSSPLATTE und AUSWERFER** (nicht möglich für 1 & 2 mm Stanzen) fügen Sie ein "FE" hinter die Artikelnummer  
 For **THIN FOOTPLATE and EJECTOR** (not available for 1 & 2 mm punches) please add "FE" behind the item number  
 Para **FOOTPLATE FINO y el EJECTOR** (no disponible para los sacadores de 1 y 2 mm) agregue por favor "FE" detrás del número del artículo  
 Per **FOOTPLATE SOTTILE e l'ESPULSORE** (non disponibile per i punzoni da 1 & 2 mm) aggiunga prego la "FE" dietro il numero dell'articolo



**STEEL**  
STAINLESS

**FERRIS-SMITH-KERRISON**

**L**



Bissbreite	Schaftlänge	40° nach oben	40° nach oben	90° nach oben
Width of bite	Length of shaft	40° upwards	40° upwards	90° upwards
Ancura de la boca	Longitud del vástago	40° hacia arriba	40° hacia arriba	90° hacia arriba
Larghezza del morso	Lunghezza dell'asta	40° verso l'alto	40° verso l'alto	90° verso l'alto

1,0 mm	180 mm, 7"	<b>40-014-01 Z</b>		<b>40-016-01 Z</b>
2,0 mm	180 mm, 7"	<b>40-014-02 Z</b>		<b>40-016-02 Z</b>
3,0 mm	180 mm, 7"	<b>40-014-03 Z</b>		<b>40-016-03 ZE</b>
4,0 mm	180 mm, 7"	<b>40-014-04 Z</b>		<b>40-016-04 ZE</b>
5,0 mm	180 mm, 7"	<b>40-014-05 Z</b>		<b>40-016-05 ZE</b>
6,0 mm	180 mm, 7"	<b>40-014-06 Z</b>		<b>40-016-06 ZE</b>
1,0 mm	200 mm, 8"	<b>40-014-11 Z</b>		<b>40-016-11 Z</b>
2,0 mm	200 mm, 8"	<b>40-014-12 Z</b>	<b>40-015-12 ZF</b>	<b>40-016-12 Z</b>
3,0 mm	200 mm, 8"	<b>40-014-13 Z</b>	<b>40-015-13 ZF</b>	<b>40-016-13 ZE</b>
4,0 mm	200 mm, 8"	<b>40-014-14 Z</b>	<b>40-015-14 ZF</b>	<b>40-016-14 ZE</b>
5,0 mm	200 mm, 8"	<b>40-014-15 Z</b>	<b>40-015-15 ZF</b>	<b>40-016-15 ZE</b>
6,0 mm	200 mm, 8"	<b>40-014-16 Z</b>		<b>40-016-16 ZE</b>
1,0 mm	230 mm, 9"	<b>40-014-21 Z</b>		<b>40-016-21 Z</b>
2,0 mm	230 mm, 9"	<b>40-014-22 Z</b>		<b>40-016-22 Z</b>
3,0 mm	230 mm, 9"	<b>40-014-23 Z</b>		<b>40-016-23 ZE</b>
4,0 mm	230 mm, 9"	<b>40-014-24 Z</b>		<b>40-016-24 ZE</b>
5,0 mm	230 mm, 9"	<b>40-014-25 Z</b>		<b>40-016-25 ZE</b>
6,0 mm	230 mm, 9"	<b>40-014-26 Z</b>		<b>40-016-26 ZE</b>

Weitere Längen auf Anfrage  
 Other lengths on request  
 Otras longitudes bajo pedido  
 Ulteriori lunghezze su richiesta

3,0 - 6,0 mm mit Auswerfer  
 3,0 - 6,0 mm with Ejector  
 3,0 - 6,0 mm con Ejector  
 3,0 - 6,0 mm con Ejector

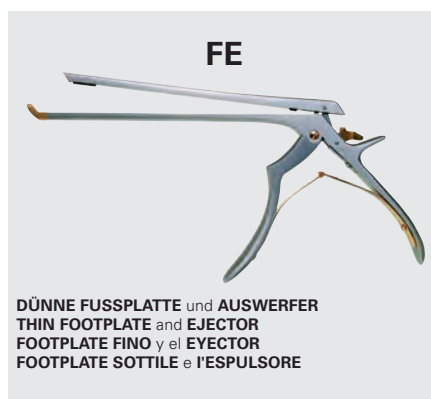
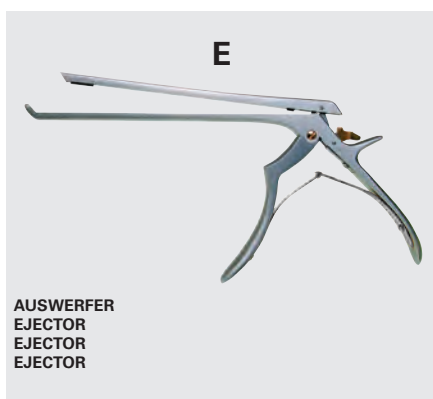
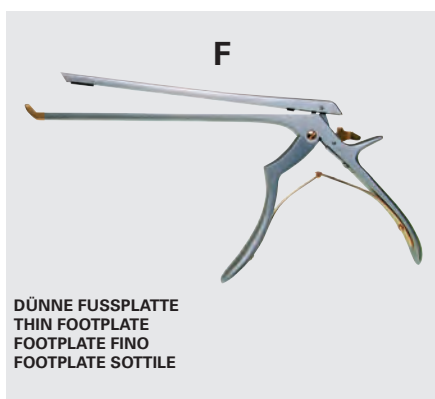
Laminektomie-Stanzen, zerlegbar  
 Laminectomy punches, detachable  
 Pinzas cortantes para laminectomía, desmontable  
 Pinze per laminectomia, smontabile



STEEL  
STAINLESS

STEEL  
STAINLESS

STEEL  
STAINLESS



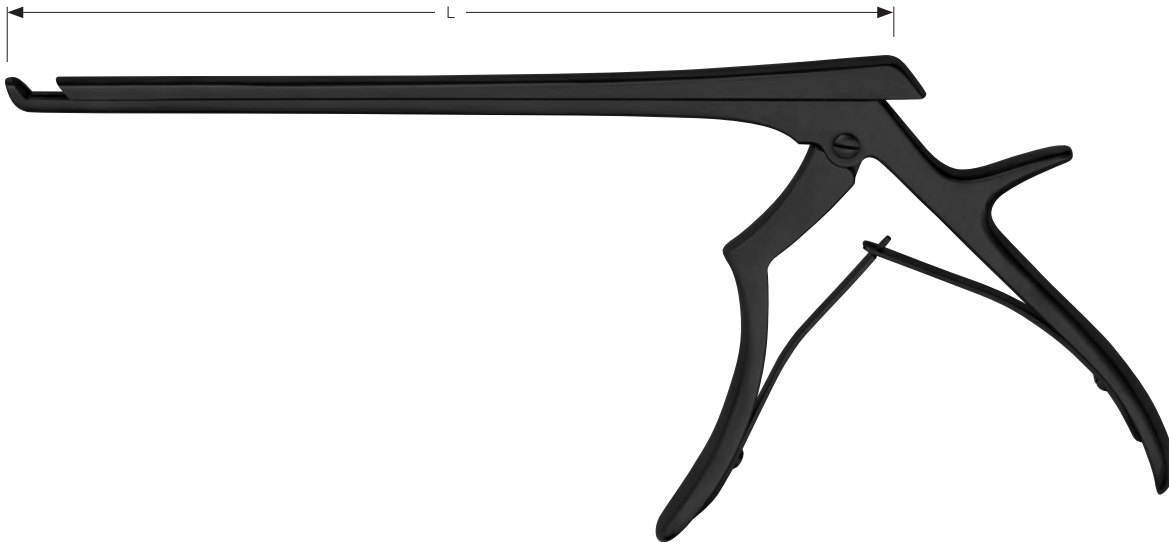
Für **AUSWERFER** fügen Sie ein "E" hinter die Artikelnummer (nicht möglich für 1 & 2 mm Stanzen & 40-015-12 ZF - 40-015-15 ZF)  
 For **EJECTOR** please add "E" behind the item number (not available for 1 & 2 mm punches & 40-015-12 ZF - 40-015-15 ZF)  
 Para el **EJECTOR** agregue por favor "E" detrás del número del artículo (no disponible para los sacadores de 1 y 2 mm & 40-015-12 ZF - 40-015-15 ZF)  
 Per **EJECTOR** aggiunga prego la "E" dietro il numero dell'articolo (non disponibile per i punzoni da 1 & 2 mm & 40-015-12 ZF - 40-015-15 ZF)



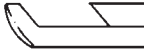
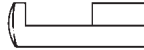
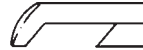
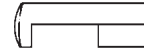
Für **DÜNNE FUSSPLATTE** fügen Sie ein "F" hinter die Artikelnummer  
 For **THIN FOOTPLATE** please add "F" behind the item number  
 Para el **FOOTPLATE FINO** agregue por favor "F" detrás del número del artículo  
 Per **FOOTPLATE SOTTILE** aggiunga prego la "F" dietro il numero dell'articolo



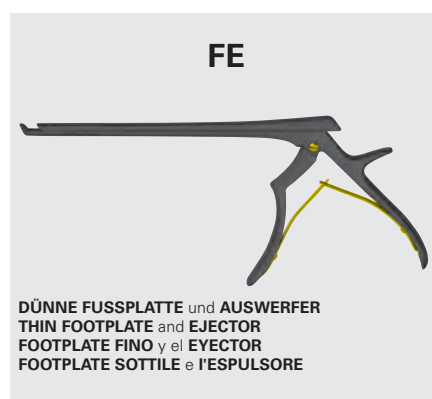
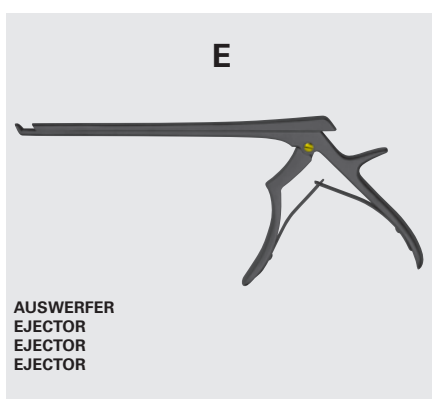
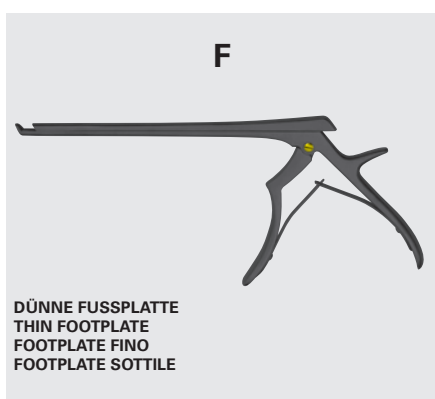
Für **DÜNNE FUSSPLATTE und AUSWERFER** (nicht möglich für 1 & 2 mm Stanzen & 40-015-12 ZF - 40-015-15 ZF) fügen Sie ein "FE" hinter die Artikelnummer  
 For **THIN FOOTPLATE and EJECTOR** (not available for 1 & 2 mm punches & 40-015-12 ZF - 40-015-15 ZF) please add "FE" behind the item number  
 Para **FOOTPLATE FINO y el EJECTOR** (no disponible para los sacadores de 1 y 2 mm & 40-015-12 ZF - 40-015-15 ZF) agregue por favor "FE" detrás del número del artículo  
 Per **FOOTPLATE SOTTILE e l'ESPULSORE** (non disponibile per i punzoni da 1 & 2 mm & 40-015-12 ZF - 40-015-15 ZF) aggiunga prego la "FE" dietro il numero dell'articolo



**FERRIS-SMITH-KERRISON**

		L				
Bissbreite	Schaftlänge		40° nach oben	90° nach oben	40° nach unten	90° nach unten
Width of bite	Length of shaft		40° upwards	90° upwards	40° downwards	90° downwards
Ancura de la boca	Longitud del vástago		40° hacia arriba	90° hacia arriba	40° hacia abajo	90° hacia abajo
Larghezza del morso	Lunghhezza dell'asta		40° verso l'alto	90° verso l'alto	40° verso il basso	90° il basso
1,0 mm	180 mm, 7"	<b>40-014-01 B</b>	<b>40-016-01 B</b>	<b>40-017-01 B</b>	<b>40-019-01 B</b>	
2,0 mm	180 mm, 7"	<b>40-014-02 B</b>	<b>40-016-02 B</b>	<b>40-017-02 B</b>	<b>40-019-02 B</b>	
3,0 mm	180 mm, 7"	<b>40-014-03 B</b>	<b>40-016-03 B</b>	<b>40-017-03 B</b>	<b>40-019-03 B</b>	
4,0 mm	180 mm, 7"	<b>40-014-04 B</b>	<b>40-016-04 B</b>	<b>40-017-04 B</b>	<b>40-019-04 B</b>	
5,0 mm	180 mm, 7"	<b>40-014-05 B</b>	<b>40-016-05 B</b>	<b>40-017-05 B</b>	<b>40-019-05 B</b>	
6,0 mm	180 mm, 7"	<b>40-014-06 B</b>	<b>40-016-06 B</b>	<b>40-017-06 B</b>	<b>40-019-06 B</b>	
1,0 mm	200 mm, 8"	<b>40-014-11 B</b>	<b>40-016-11 B</b>	<b>40-017-11 B</b>	<b>40-019-11 B</b>	
2,0 mm	200 mm, 8"	<b>40-014-12 B</b>	<b>40-016-12 B</b>	<b>40-017-12 B</b>	<b>40-019-12 B</b>	
3,0 mm	200 mm, 8"	<b>40-014-13 B</b>	<b>40-016-13 B</b>	<b>40-017-13 B</b>	<b>40-019-13 B</b>	
4,0 mm	200 mm, 8"	<b>40-014-14 B</b>	<b>40-016-14 B</b>	<b>40-017-14 B</b>	<b>40-019-14 B</b>	
5,0 mm	200 mm, 8"	<b>40-014-15 B</b>	<b>40-016-15 B</b>	<b>40-017-15 B</b>	<b>40-019-15 B</b>	
6,0 mm	200 mm, 8"	<b>40-014-16 B</b>	<b>40-016-16 B</b>	<b>40-017-16 B</b>	<b>40-019-16 B</b>	
1,0 mm	230 mm, 9"	<b>40-014-21 B</b>	<b>40-016-21 B</b>	<b>40-017-21 B</b>	<b>40-019-21 B</b>	
2,0 mm	230 mm, 9"	<b>40-014-22 B</b>	<b>40-016-22 B</b>	<b>40-017-22 B</b>	<b>40-019-22 B</b>	
3,0 mm	230 mm, 9"	<b>40-014-23 B</b>	<b>40-016-23 B</b>	<b>40-017-23 B</b>	<b>40-019-23 B</b>	
4,0 mm	230 mm, 9"	<b>40-014-24 B</b>	<b>40-016-24 B</b>	<b>40-017-24 B</b>	<b>40-019-24 B</b>	
5,0 mm	230 mm, 9"	<b>40-014-25 B</b>	<b>40-016-25 B</b>	<b>40-017-25 B</b>	<b>40-019-25 B</b>	
6,0 mm	230 mm, 9"	<b>40-014-26 B</b>	<b>40-016-26 B</b>	<b>40-017-26 B</b>	<b>40-019-26 B</b>	

Weitere Längen auf Anfrage  
Other lengths on request  
Otras longitudes bajo pedido  
Ulteriori lunghezze su richiesta



Für **AUSWERFER** fügen Sie ein "E" hinter die Artikelnummer (nicht möglich für 1 & 2 mm Stanzen)  
For **EJECTOR** please add "E" behind the item number (not available for 1 & 2 mm punches)  
Para el **EJECTOR** agregue por favor "E" detrás del número del artículo (no disponible para los sacadores de 1 y 2 mm)  
Per **EJECTOR** aggiunga prego la "E" dietro il numero dell'articolo (non disponibile per i punzoni da 1 & 2 mm)



Für **DÜNNE FUSSPLATTE** fügen Sie ein "F" hinter die Artikelnummer  
For **THIN FOOTPLATE** please add "F" behind the item number  
Para el **FOOTPLATE FINO** agregue por favor "F" detrás del número del artículo  
Per **FOOTPLATE SOTTILE** aggiunga prego la "F" dietro il numero dell'articolo

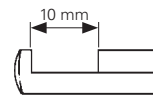
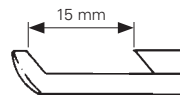
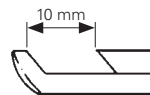


Für **DÜNNE FUSSPLATTE und AUSWERFER** (nicht möglich für 1 & 2 mm Stanzen) fügen Sie ein "FE" hinter die Artikelnummer  
For **THIN FOOTPLATE and EJECTOR** (not available for 1 & 2 mm punches) please add "FE" behind the item number  
Para **FOOTPLATE FINO y el EJECTOR** (no disponible para los sacadores de 1 y 2 mm) agregue por favor "FE" detrás del número del artículo  
Per **FOOTPLATE SOTTILE e l'ESPULSORE** (non disponibile per i punzoni da 1 & 2 mm) aggiunga prego la "FE" dietro il numero dell'articolo



**FERRIS-SMITH-KERRISON**

L



Bissbreite	Schaftlänge	40° nach oben	40° nach oben	90° nach oben
Width of bite	Length of shaft	40° upwards	40° upwards	90° upwards
Ancura de la boca	Longitud del vástago	40° hacia arriba	40° hacia arriba	90° hacia arriba
Larghezza del morso	Lunghezza dell'asta	40° verso l'alto	40° verso l'alto	90° verso l'alto

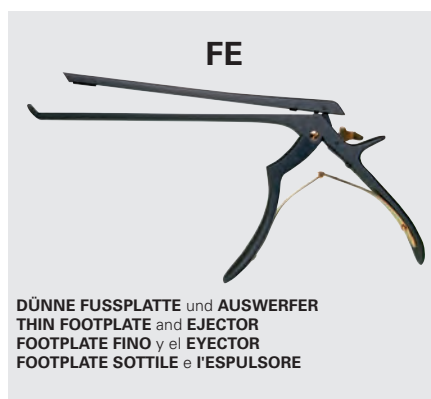
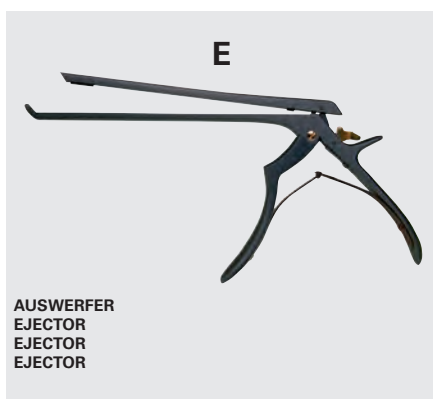
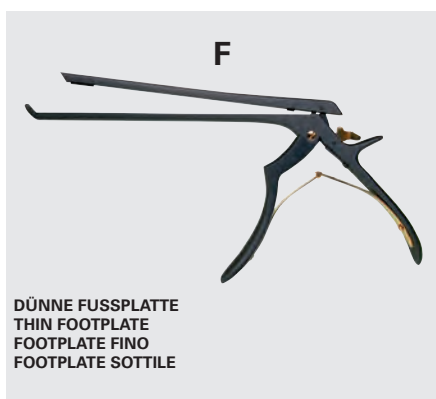
1,0 mm	180 mm, 7"	<b>40-014-01 ZB</b>		<b>40-016-01 ZB</b>
2,0 mm	180 mm, 7"	<b>40-014-02 ZB</b>		<b>40-016-02 ZB</b>
3,0 mm	180 mm, 7"	<b>40-014-03 ZB</b>		<b>40-016-03 ZBE</b>
4,0 mm	180 mm, 7"	<b>40-014-04 ZB</b>		<b>40-016-04 ZBE</b>
5,0 mm	180 mm, 7"	<b>40-014-05 ZB</b>		<b>40-016-05 ZBE</b>
6,0 mm	180 mm, 7"	<b>40-014-06 ZB</b>		<b>40-016-06 ZBE</b>
1,0 mm	200 mm, 8"	<b>40-014-11 ZB</b>		<b>40-016-11 ZB</b>
2,0 mm	200 mm, 8"	<b>40-014-12 ZB</b>	<b>40-015-12 ZBF</b>	<b>40-016-12 ZB</b>
3,0 mm	200 mm, 8"	<b>40-014-13 ZB</b>	<b>40-015-13 ZBF</b>	<b>40-016-13 ZBE</b>
4,0 mm	200 mm, 8"	<b>40-014-14 ZB</b>	<b>40-015-14 ZBF</b>	<b>40-016-14 ZBE</b>
5,0 mm	200 mm, 8"	<b>40-014-15 ZB</b>	<b>40-015-15 ZBF</b>	<b>40-016-15 ZBE</b>
6,0 mm	200 mm, 8"	<b>40-014-16 ZB</b>		<b>40-016-16 ZBE</b>
1,0 mm	230 mm, 9"	<b>40-014-21 ZB</b>		<b>40-016-21 ZB</b>
2,0 mm	230 mm, 9"	<b>40-014-22 ZB</b>		<b>40-016-22 ZB</b>
3,0 mm	230 mm, 9"	<b>40-014-23 ZB</b>		<b>40-016-23 ZBE</b>
4,0 mm	230 mm, 9"	<b>40-014-24 ZB</b>		<b>40-016-24 ZBE</b>
5,0 mm	230 mm, 9"	<b>40-014-25 ZB</b>		<b>40-016-25 ZBE</b>
6,0 mm	230 mm, 9"	<b>40-014-26 ZB</b>		<b>40-016-26 ZBE</b>

Weitere Längen auf Anfrage  
Other lengths on request  
Otras longitudes bajo pedido  
Ulteriori lunghezze su richiesta

3,0 - 6,0 mm mit Auswerfer  
3,0 - 6,0 mm with Ejector  
3,0 - 6,0 mm con Ejector  
3,0 - 6,0 mm con Ejector



Laminektomie-Stanzen, zerlegbar  
 Laminectomy punches, detachable  
 Pinzas cortantes para laminectomía, desmontable  
 Pinze per laminectomia, smontabile



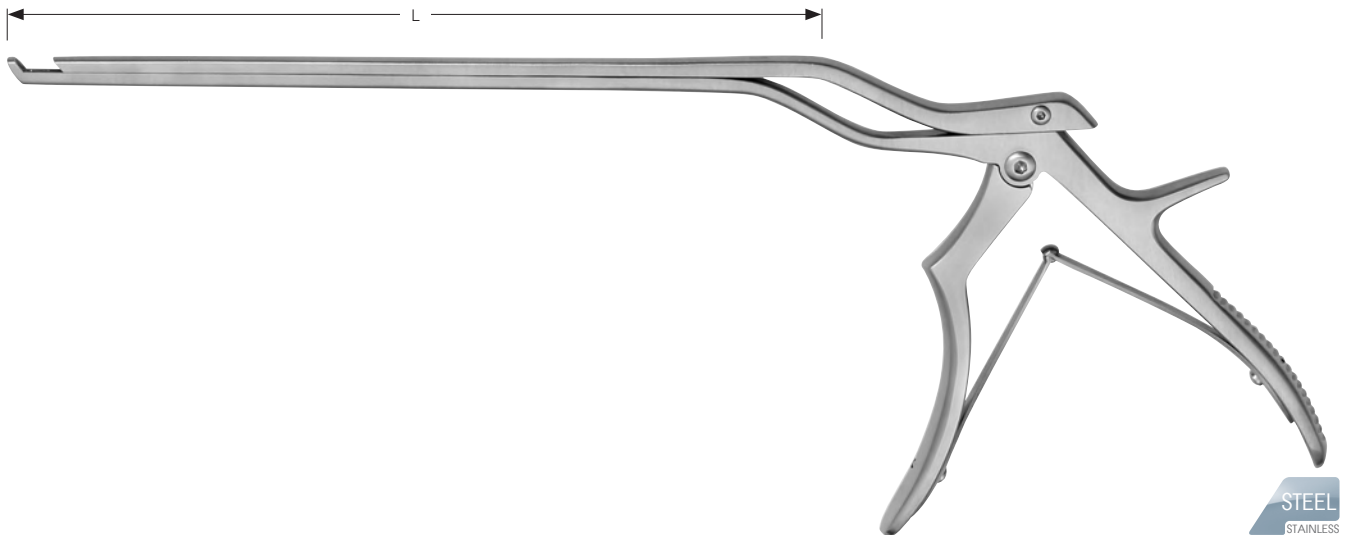
Für **AUSWERFER** fügen Sie ein "E" hinter die Artikelnummer (nicht möglich für 1 & 2 mm Stanzen & 40-015-12 ZF - 40-015-15 ZF)  
 For **EJECTOR** please add "E" behind the item number (not available for 1 & 2 mm punches & 40-015-12 ZF - 40-015-15 ZF)  
 Para el **EJECTOR** agregue por favor "E" detrás del número del artículo (no disponible para los sacadores de 1 y 2 mm & 40-015-12 ZF - 40-015-15 ZF)  
 Per **EJECTOR** aggiunga prego la "E" dietro il numero dell'articolo (non disponibile per i punzoni da 1 & 2 mm & 40-015-12 ZF - 40-015-15 ZF)



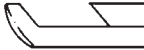
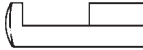
Für **DÜNNE FUSSPLATTE** fügen Sie ein "F" hinter die Artikelnummer  
 For **THIN FOOTPLATE** please add "F" behind the item number  
 Para el **FOOTPLATE FINO** agregue por favor "F" detrás del número del artículo  
 Per **FOOTPLATE SOTTILE** aggiunga prego la "F" dietro il numero dell'articolo



Für **DÜNNE FUSSPLATTE und AUSWERFER** (nicht möglich für 1 & 2 mm Stanzen & 40-015-12 ZF - 40-015-15 ZF) fügen Sie ein "FE" hinter die Artikelnummer  
 For **THIN FOOTPLATE and EJECTOR** (not available for 1 & 2 mm punches & 40-015-12 ZF - 40-015-15 ZF) please add "FE" behind the item number  
 Para **FOOTPLATE FINO y el EJECTOR** (no disponible para los sacadores de 1 y 2 mm & 40-015-12 ZF - 40-015-15 ZF) agregue por favor "FE" detrás del número del artículo  
 Per **FOOTPLATE SOTTILE e l'ESPULSORE** (non disponibile per i punzoni da 1 & 2 mm & 40-015-12 ZF - 40-015-15 ZF) aggiunga prego la "FE" dietro il numero dell'articolo



## BAYONET-KERRISON

	L		
Bissbreite	Schaftlänge	40° nach oben	90° nach oben
Width of bite	Length of shaft	40° upwards	90° upwards
Ancura de la boca	Longitud del vástago	40° hacia arriba	90° hacia arriba
Larghezza del morso	Lunghezza dell'asta	40° verso l'alto	90° verso l'alto
1,0 mm	110 mm, 4 3/8"	<b>40-020-01</b>	<b>40-021-01</b>
2,0 mm	110 mm, 4 3/8"	<b>40-020-02</b>	<b>40-021-02</b>
3,0 mm	110 mm, 4 3/8"	<b>40-020-03</b>	<b>40-021-03</b>
4,0 mm	110 mm, 4 3/8"	<b>40-020-04</b>	<b>40-021-04</b>
5,0 mm	110 mm, 4 3/8"	<b>40-020-05</b>	<b>40-021-05</b>
6,0 mm	110 mm, 4 3/8"	<b>40-020-06</b>	<b>40-021-06</b>
1,0 mm	150 mm, 6"	<b>40-020-11</b>	<b>40-021-11</b>
2,0 mm	150 mm, 6"	<b>40-020-12</b>	<b>40-021-12</b>
3,0 mm	150 mm, 6"	<b>40-020-13</b>	<b>40-021-13</b>
4,0 mm	150 mm, 6"	<b>40-020-14</b>	<b>40-021-14</b>
5,0 mm	150 mm, 6"	<b>40-020-15</b>	<b>40-021-15</b>
6,0 mm	150 mm, 6"	<b>40-020-16</b>	<b>40-021-16</b>
1,0 mm	180 mm, 7"	<b>40-020-21</b>	<b>40-021-21</b>
2,0 mm	180 mm, 7"	<b>40-020-22</b>	<b>40-021-22</b>
3,0 mm	180 mm, 7"	<b>40-020-23</b>	<b>40-021-23</b>
4,0 mm	180 mm, 7"	<b>40-020-24</b>	<b>40-021-24</b>
5,0 mm	180 mm, 7"	<b>40-020-25</b>	<b>40-021-25</b>
6,0 mm	180 mm, 7"	<b>40-020-26</b>	<b>40-021-26</b>

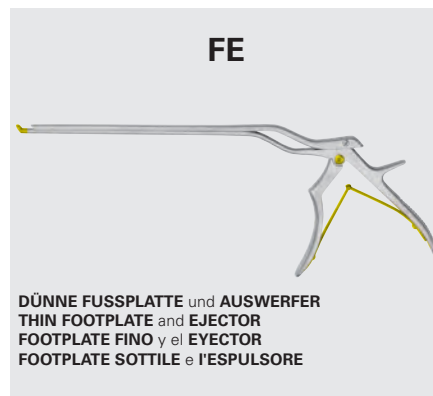
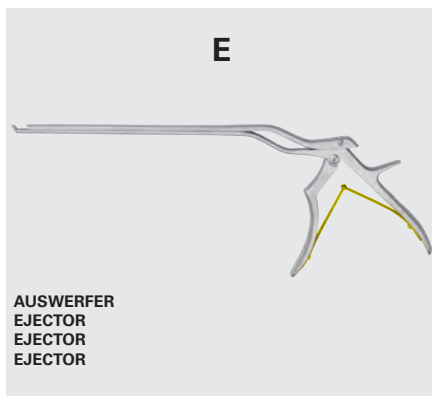
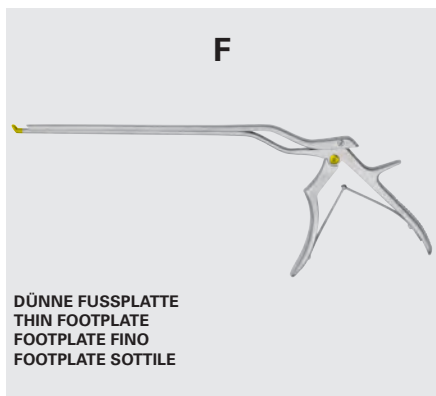
Weitere Längen auf Anfrage  
Other lengths on request  
Otras longitudes bajo pedido  
Ulteriori lunghezze su richiesta



STEEL  
STAINLESS

STEEL  
STAINLESS

STEEL  
STAINLESS



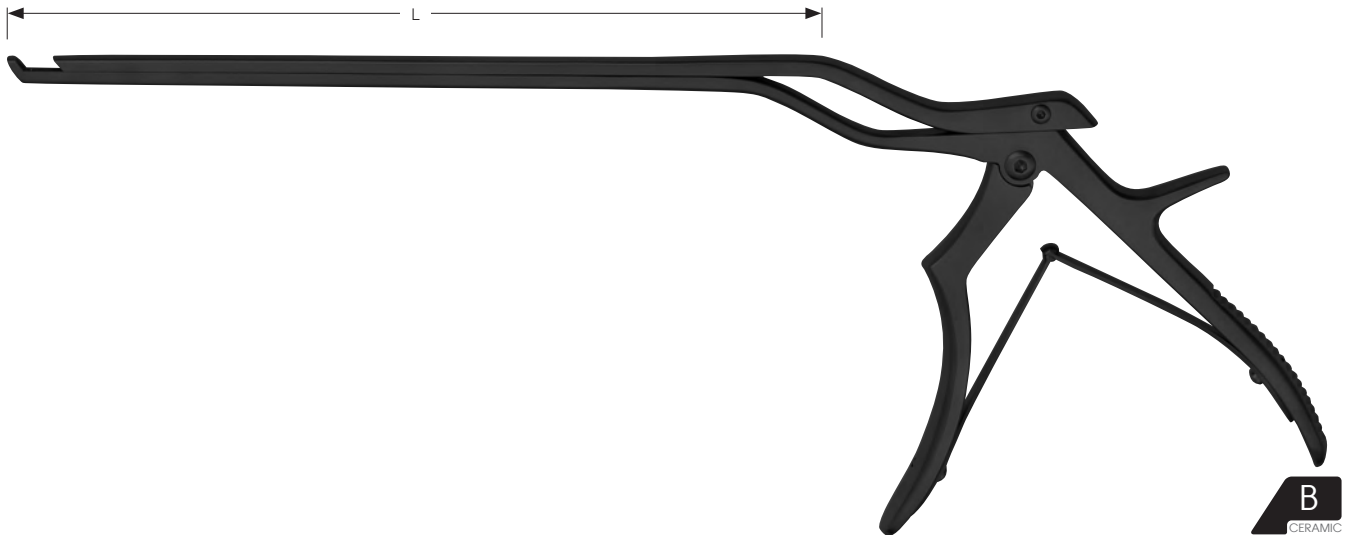
Für **AUSWERFER** fügen Sie ein "E" hinter die Artikelnummer (nicht möglich für 1 & 2 mm Stanzen)  
 For **EJECTOR** please add "E" behind the item number (not available for 1 & 2 mm punches)  
 Para el **EJECTOR** agregue por favor "E" detrás del número del artículo (no disponible para los sacadores de 1 y 2 mm)  
 Per **EJECTOR** aggiunga prego la "E" dietro il numero dell'articolo (non disponibile per i punzoni da 1 & 2 mm)



Für **DÜNNE FUSSPLATTE** fügen Sie ein "F" hinter die Artikelnummer  
 For **THIN FOOTPLATE** please add "F" behind the item number  
 Para el **FOOTPLATE FINO** agregue por favor "F" detrás del número del artículo  
 Per **FOOTPLATE SOTTILE** aggiunga prego la "F" dietro il numero dell'articolo

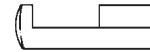
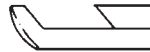


Für **DÜNNE FUSSPLATTE** und **AUSWERFER** (nicht möglich für 1 & 2 mm Stanzen) fügen Sie ein "FE" hinter die Artikelnummer  
 For **THIN FOOTPLATE** and **EJECTOR** (not available for 1 & 2 mm punches) please add "FE" behind the item number  
 Para **FOOTPLATE FINO** y el **EJECTOR** (no disponible para los sacadores de 1 y 2 mm) agregue por favor "FE" detrás del número del artículo  
 Per **FOOTPLATE SOTTILE** e **l'ESPULSORE** (non disponibile per i punzoni da 1 & 2 mm) aggiunga prego la "FE" dietro il numero dell'articolo



## BAYONET-KERRISON

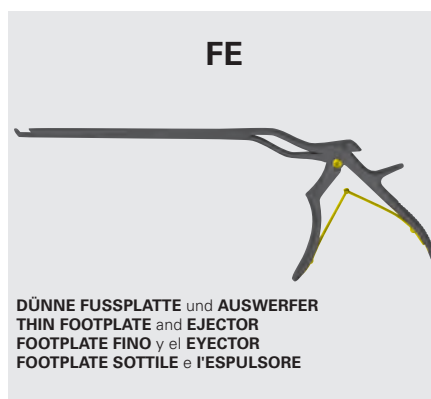
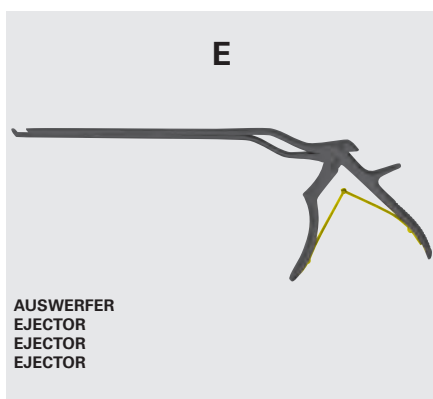
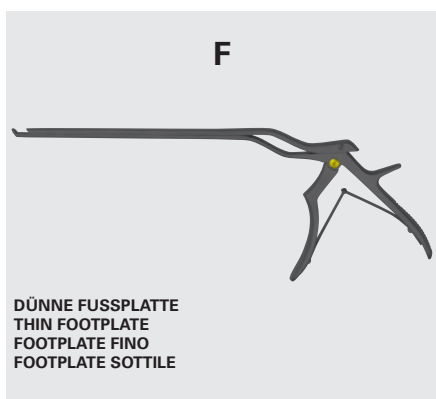
L



Bissbreite Width of bite Ancura de la boca Larghezza del morso	Schaftlänge Length of shaft Longitud del vástago Lunghezza dell'asta	40° nach oben 40° upwards 40° hacia arriba 40° verso l'alto	90° nach oben 90° upwards 90° hacia arriba 90° verso l'alto
---	---	--	--

1,0 mm	110 mm, 4 <sup>3</sup> / <sub>8</sub> "	<b>40-020-01 B</b>	<b>40-021-01 B</b>
2,0 mm	110 mm, 4 <sup>3</sup> / <sub>8</sub> "	<b>40-020-02 B</b>	<b>40-021-02 B</b>
3,0 mm	110 mm, 4 <sup>3</sup> / <sub>8</sub> "	<b>40-020-03 B</b>	<b>40-021-03 B</b>
4,0 mm	110 mm, 4 <sup>3</sup> / <sub>8</sub> "	<b>40-020-04 B</b>	<b>40-021-04 B</b>
5,0 mm	110 mm, 4 <sup>3</sup> / <sub>8</sub> "	<b>40-020-05 B</b>	<b>40-021-05 B</b>
6,0 mm	110 mm, 4 <sup>3</sup> / <sub>8</sub> "	<b>40-020-06 B</b>	<b>40-021-06 B</b>
1,0 mm	150 mm, 6 "	<b>40-020-11 B</b>	<b>40-021-11 B</b>
2,0 mm	150 mm, 6 "	<b>40-020-12 B</b>	<b>40-021-12 B</b>
3,0 mm	150 mm, 6 "	<b>40-020-13 B</b>	<b>40-021-13 B</b>
4,0 mm	150 mm, 6 "	<b>40-020-14 B</b>	<b>40-021-14 B</b>
5,0 mm	150 mm, 6 "	<b>40-020-15 B</b>	<b>40-021-15 B</b>
6,0 mm	150 mm, 6 "	<b>40-020-16 B</b>	<b>40-021-16 B</b>
1,0 mm	180 mm, 7 "	<b>40-020-21 B</b>	<b>40-021-21 B</b>
2,0 mm	180 mm, 7 "	<b>40-020-22 B</b>	<b>40-021-22 B</b>
3,0 mm	180 mm, 7 "	<b>40-020-23 B</b>	<b>40-021-23 B</b>
4,0 mm	180 mm, 7 "	<b>40-020-24 B</b>	<b>40-021-24 B</b>
5,0 mm	180 mm, 7 "	<b>40-020-25 B</b>	<b>40-021-25 B</b>
6,0 mm	180 mm, 7 "	<b>40-020-26 B</b>	<b>40-021-26 B</b>

Weitere Längen auf Anfrage  
Other lengths on request  
Otras longitudes bajo pedido  
Ulteriori lunghezze su richiesta



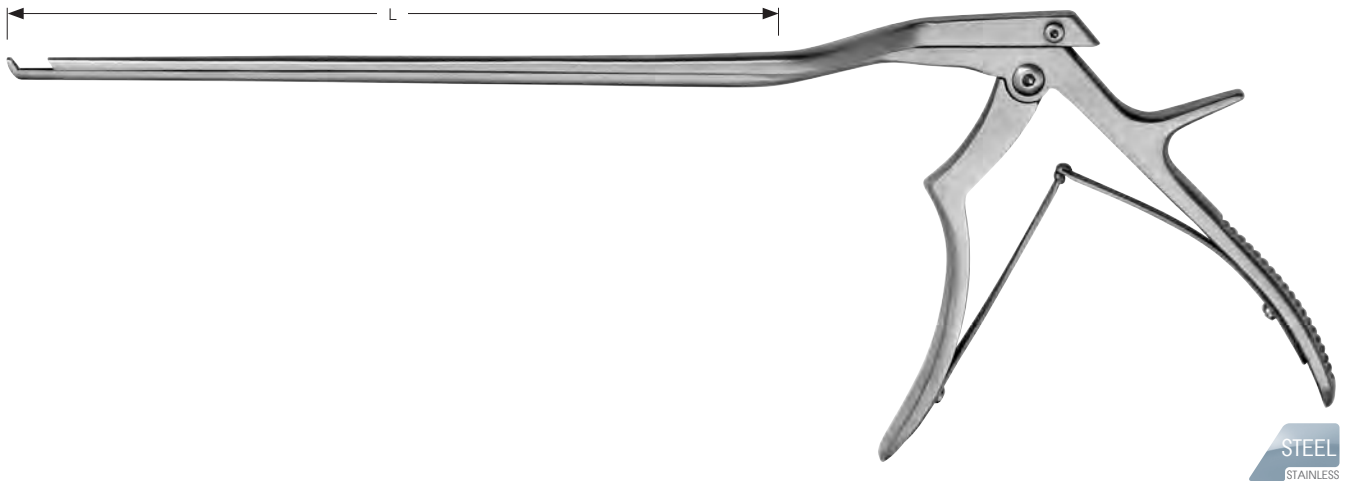
Für **AUSWERFER** fügen Sie ein "E" hinter die Artikelnummer (nicht möglich für 1 & 2 mm Stanzen)  
 For **EJECTOR** please add "E" behind the item number (not available for 1 & 2 mm punches)  
 Para el **EJECTOR** agregue por favor "E" detrás del número del artículo (no disponible para los sacadores de 1 y 2 mm)  
 Per **EJECTOR** aggiunga prego la "E" dietro il numero dell'articolo (non disponibile per i punzoni da 1 & 2 mm)



Für **DÜNNE FUSSPLATTE** fügen Sie ein "F" hinter die Artikelnummer  
 For **THIN FOOTPLATE** please add "F" behind the item number  
 Para el **FOOTPLATE FINO** agregue por favor "F" detrás del número del artículo  
 Per **FOOTPLATE SOTTILE** aggiunga prego la "F" dietro il numero dell'articolo



Für **DÜNNE FUSSPLATTE und AUSWERFER** (nicht möglich für 1 & 2 mm Stanzen) fügen Sie ein "FE" hinter die Artikelnummer  
 For **THIN FOOTPLATE and EJECTOR** (not available for 1 & 2 mm punches) please add "FE" behind the item number  
 Para **FOOTPLATE FINO y el EJECTOR** (no disponible para los sacadores de 1 y 2 mm) agregue por favor "FE" detrás del número del artículo  
 Per **FOOTPLATE SOTTILE e l'ESPULSORE** (non disponibile per i punzoni da 1 & 2 mm) aggiunga prego la "FE" dietro il numero dell'articolo



**BAYONET-KERRISON**

links | left  
izquierda | sinistra

rechts | right  
derecha | destra

L



Bissbreite Width of bite Ancura de la boca Larghezza del morso	Schaftlänge Length of shaft Longitud del vástago Lunghezza dell'asta	40° nach oben 40° upwards 40° hacia arriba 40° verso l'alto	90° nach oben 90° upwards 90° hacia arriba 90° verso l'alto	40° nach oben 40° upwards 40° hacia arriba 40° verso l'alto	90° nach oben 90° upwards 90° hacia arriba 90° verso l'alto
---	---	--	--	--	--

1,0 mm	110 mm, 4 3/8"	<b>40-022-01</b>	<b>40-023-01</b>	<b>40-022-31</b>	<b>40-023-31</b>
2,0 mm	110 mm, 4 3/8"	<b>40-022-02</b>	<b>40-023-02</b>	<b>40-022-32</b>	<b>40-023-32</b>
3,0 mm	110 mm, 4 3/8"	<b>40-022-03</b>	<b>40-023-03</b>	<b>40-022-33</b>	<b>40-023-33</b>
4,0 mm	110 mm, 4 3/8"	<b>40-022-04</b>	<b>40-023-04</b>	<b>40-022-34</b>	<b>40-023-34</b>
5,0 mm	110 mm, 4 3/8"	<b>40-022-05</b>	<b>40-023-05</b>	<b>40-022-35</b>	<b>40-023-35</b>
6,0 mm	110 mm, 4 3/8"	<b>40-022-06</b>	<b>40-023-06</b>	<b>40-022-36</b>	<b>40-023-36</b>
1,0 mm	150 mm, 6"	<b>40-022-11</b>	<b>40-023-11</b>	<b>40-022-41</b>	<b>40-023-41</b>
2,0 mm	150 mm, 6"	<b>40-022-12</b>	<b>40-023-12</b>	<b>40-022-42</b>	<b>40-023-42</b>
3,0 mm	150 mm, 6"	<b>40-022-13</b>	<b>40-023-13</b>	<b>40-022-43</b>	<b>40-023-43</b>
4,0 mm	150 mm, 6"	<b>40-022-14</b>	<b>40-023-14</b>	<b>40-022-44</b>	<b>40-023-44</b>
5,0 mm	150 mm, 6"	<b>40-022-15</b>	<b>40-023-15</b>	<b>40-022-45</b>	<b>40-023-45</b>
6,0 mm	150 mm, 6"	<b>40-022-16</b>	<b>40-023-16</b>	<b>40-022-46</b>	<b>40-023-46</b>
1,0 mm	180 mm, 7"	<b>40-022-21</b>	<b>40-023-21</b>	<b>40-022-51</b>	<b>40-023-51</b>
2,0 mm	180 mm, 7"	<b>40-022-22</b>	<b>40-023-22</b>	<b>40-022-52</b>	<b>40-023-52</b>
3,0 mm	180 mm, 7"	<b>40-022-23</b>	<b>40-023-23</b>	<b>40-022-53</b>	<b>40-023-53</b>
4,0 mm	180 mm, 7"	<b>40-022-24</b>	<b>40-023-24</b>	<b>40-022-54</b>	<b>40-023-54</b>
5,0 mm	180 mm, 7"	<b>40-022-25</b>	<b>40-023-25</b>	<b>40-022-55</b>	<b>40-023-55</b>
6,0 mm	180 mm, 7"	<b>40-022-26</b>	<b>40-023-26</b>	<b>40-022-56</b>	<b>40-023-56</b>

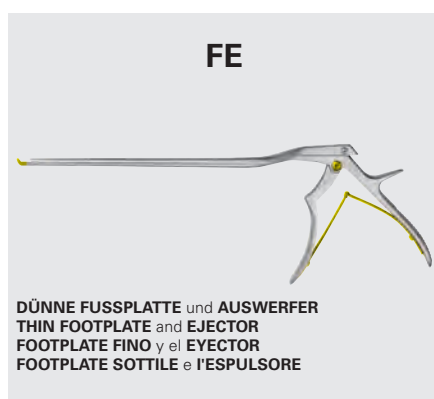
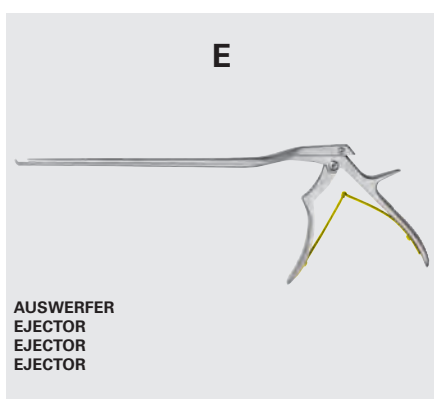
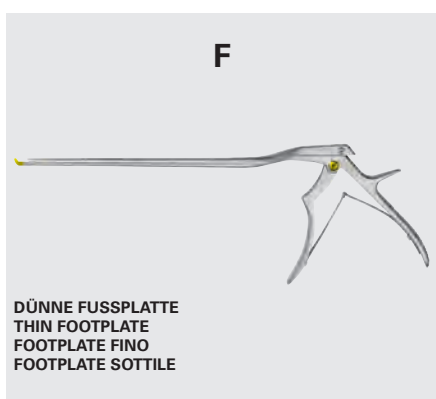
Weitere Längen auf Anfrage  
Other lengths on request  
Otras longitudes bajo pedido  
Ulteriori lunghezze su richiesta



STEEL  
 STAINLESS

STEEL  
 STAINLESS

STEEL  
 STAINLESS



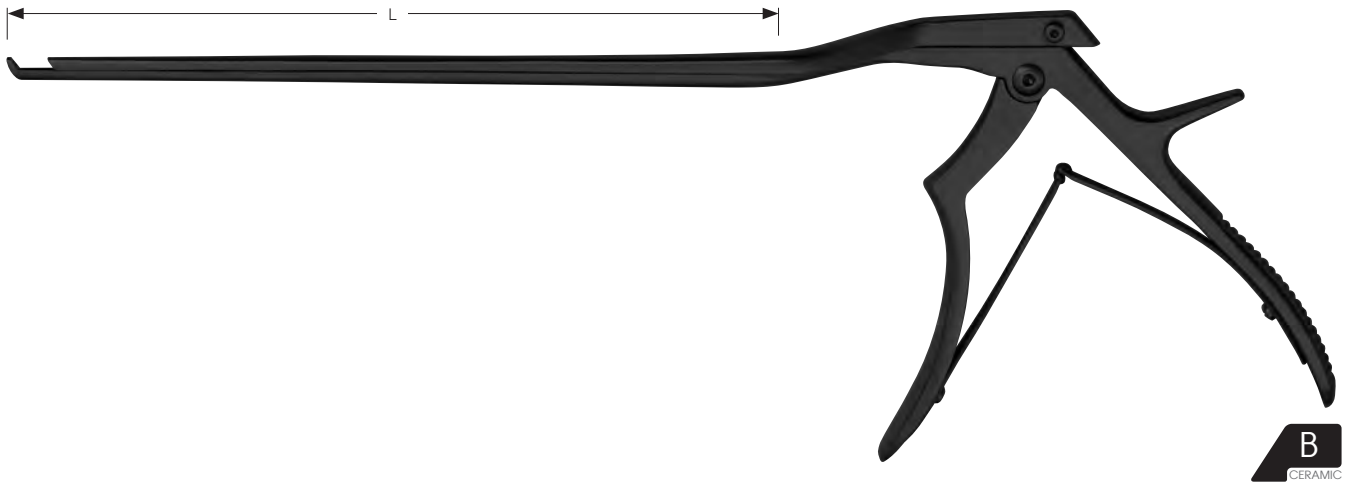
Für **AUSWERFER** fügen Sie ein "E" hinter die Artikelnummer (nicht möglich für 1 & 2 mm Stanzen)  
 For **EJECTOR** please add "E" behind the item number (not available for 1 & 2 mm punches)  
 Para el **EJECTOR** agregue por favor "E" detrás del número del artículo (no disponible para los sacadores de 1 y 2 mm)  
 Per **EJECTOR** aggiunga prego la "E" dietro il numero dell'articolo (non disponibile per i punzoni da 1 & 2 mm)



Für **DÜNNE FUSSPLATTE** fügen Sie ein "F" hinter die Artikelnummer  
 For **THIN FOOTPLATE** please add "F" behind the item number  
 Para el **FOOTPLATE FINO** agregue por favor "F" detrás del número del artículo  
 Per **FOOTPLATE SOTTILE** aggiunga prego la "F" dietro il numero dell'articolo



Für **DÜNNE FUSSPLATTE und AUSWERFER** (nicht möglich für 1 & 2 mm Stanzen) fügen Sie ein "FE" hinter die Artikelnummer  
 For **THIN FOOTPLATE and EJECTOR** (not available for 1 & 2 mm punches) please add "FE" behind the item number  
 Para **FOOTPLATE FINO y el EJECTOR** (no disponible para los sacadores de 1 y 2 mm) agregue por favor "FE" detrás del número del artículo  
 Per **FOOTPLATE SOTTILE e l'ESPULSORE** (non disponibile per i punzoni da 1 & 2 mm) aggiunga prego la "FE" dietro il numero dell'articolo



**BAYONET-KERRISON**

links | left  
izquierda | sinistra

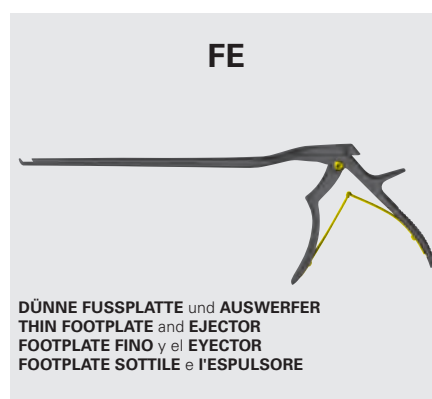
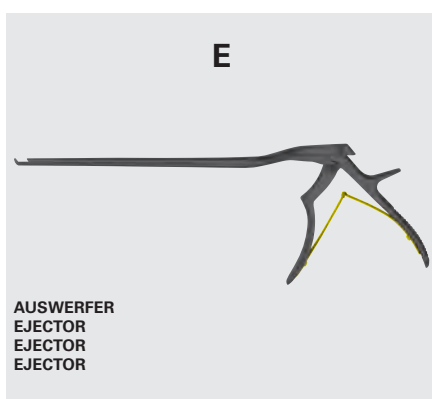
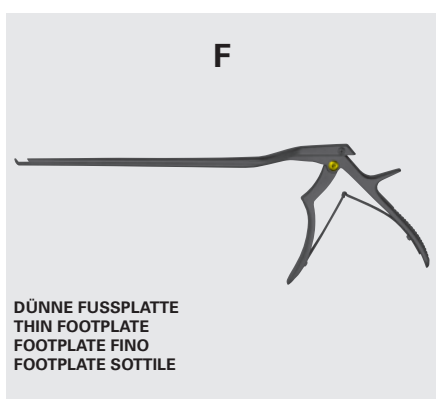
rechts | right  
derecha | destra



	L				
Bissbreite Width of bite Ancura de la boca Larghezza del morso	Schaftlänge Length of shaft Longitud del vástago Lunghezza dell'asta	40° nach oben 40° upwards 40° hacia arriba 40° verso l'alto	90° nach oben 90° upwards 90° hacia arriba 90° verso l'alto	40° nach oben 40° upwards 40° hacia arriba 40° verso l'alto	90° nach oben 90° upwards 90° hacia arriba 90° verso l'alto
1,0 mm	110 mm, 4 3/8"	<b>40-022-01 B</b>	<b>40-023-01 B</b>	<b>40-022-31 B</b>	<b>40-023-31 B</b>
2,0 mm	110 mm, 4 3/8"	<b>40-022-02 B</b>	<b>40-023-02 B</b>	<b>40-022-32 B</b>	<b>40-023-32 B</b>
3,0 mm	110 mm, 4 3/8"	<b>40-022-03 B</b>	<b>40-023-03 B</b>	<b>40-022-33 B</b>	<b>40-023-33 B</b>
4,0 mm	110 mm, 4 3/8"	<b>40-022-04 B</b>	<b>40-023-04 B</b>	<b>40-022-34 B</b>	<b>40-023-34 B</b>
5,0 mm	110 mm, 4 3/8"	<b>40-022-05 B</b>	<b>40-023-05 B</b>	<b>40-022-35 B</b>	<b>40-023-35 B</b>
6,0 mm	110 mm, 4 3/8"	<b>40-022-06 B</b>	<b>40-023-06 B</b>	<b>40-022-36 B</b>	<b>40-023-36 B</b>
1,0 mm	150 mm, 6"	<b>40-022-11 B</b>	<b>40-023-11 B</b>	<b>40-022-41 B</b>	<b>40-023-41 B</b>
2,0 mm	150 mm, 6"	<b>40-022-12 B</b>	<b>40-023-12 B</b>	<b>40-022-42 B</b>	<b>40-023-42 B</b>
3,0 mm	150 mm, 6"	<b>40-022-13 B</b>	<b>40-023-13 B</b>	<b>40-022-43 B</b>	<b>40-023-43 B</b>
4,0 mm	150 mm, 6"	<b>40-022-14 B</b>	<b>40-023-14 B</b>	<b>40-022-44 B</b>	<b>40-023-44 B</b>
5,0 mm	150 mm, 6"	<b>40-022-15 B</b>	<b>40-023-15 B</b>	<b>40-022-45 B</b>	<b>40-023-45 B</b>
6,0 mm	150 mm, 6"	<b>40-022-16 B</b>	<b>40-023-16 B</b>	<b>40-022-46 B</b>	<b>40-023-46 B</b>
1,0 mm	180 mm, 7"	<b>40-022-21 B</b>	<b>40-023-21 B</b>	<b>40-022-51 B</b>	<b>40-023-51 B</b>
2,0 mm	180 mm, 7"	<b>40-022-22 B</b>	<b>40-023-22 B</b>	<b>40-022-52 B</b>	<b>40-023-52 B</b>
3,0 mm	180 mm, 7"	<b>40-022-23 B</b>	<b>40-023-23 B</b>	<b>40-022-53 B</b>	<b>40-023-53 B</b>
4,0 mm	180 mm, 7"	<b>40-022-24 B</b>	<b>40-023-24 B</b>	<b>40-022-54 B</b>	<b>40-023-54 B</b>
5,0 mm	180 mm, 7"	<b>40-022-25 B</b>	<b>40-023-25 B</b>	<b>40-022-55 B</b>	<b>40-023-55 B</b>
6,0 mm	180 mm, 7"	<b>40-022-26 B</b>	<b>40-023-26 B</b>	<b>40-022-56 B</b>	<b>40-023-56 B</b>

Weitere Längen auf Anfrage  
Other lengths on request  
Otras longitudes bajo pedido  
Ulteriori lunghezze su richiesta





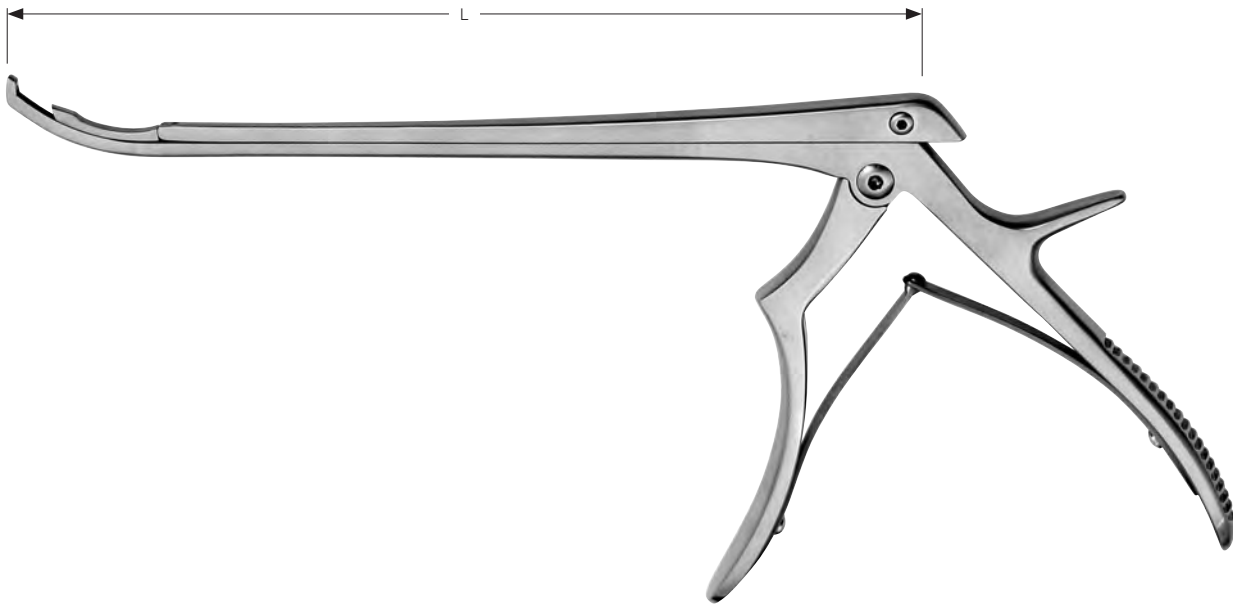
Für **AUSWERFER** fügen Sie ein "E" hinter die Artikelnummer (nicht möglich für 1 & 2 mm Stanzen)  
For **EJECTOR** please add "E" behind the item number (not available for 1 & 2 mm punches)  
Para el **EJECTOR** agregue por favor "E" detrás del número del artículo (no disponible para los sacadores de 1 y 2 mm)  
Per **EJECTOR** aggiunga prego la "E" dietro il numero dell'articolo (non disponibile per i punzoni da 1 & 2 mm)



Für **DÜNNE FUSSPLATTE** fügen Sie ein "F" hinter die Artikelnummer  
For **THIN FOOTPLATE** please add "F" behind the item number  
Para el **FOOTPLATE FINO** agregue por favor "F" detrás del número del artículo  
Per **FOOTPLATE SOTTILE** aggiunga prego la "F" dietro il numero dell'articolo



Für **DÜNNE FUSSPLATTE und AUSWERFER** (nicht möglich für 1 & 2 mm Stanzen) fügen Sie ein "FE" hinter die Artikelnummer  
For **THIN FOOTPLATE and EJECTOR** (not available for 1 & 2 mm punches) please add "FE" behind the item number  
Para **FOOTPLATE FINO y el EJECTOR** (no disponible para los sacadores de 1 y 2 mm) agregue por favor "FE" detrás del número del artículo  
Per **FOOTPLATE SOTTILE e l'ESPULSORE** (non disponibile per i punzoni da 1 & 2 mm) aggiunga prego la "FE" dietro il numero dell'articolo



STEEL  
STAINLESS

**KERRISON**

L



Bissbreite	Schaftlänge	40° nach oben	40° nach unten
Width of bite	Length of shaft	40° upwards	40° downwards
Ancura de la boca	Longitud del vástago	40° hacia arriba	40° hacia abajo
Larghezza del morso	Lunghezza dell'asta	40° verso l'alto	40° verso il basso

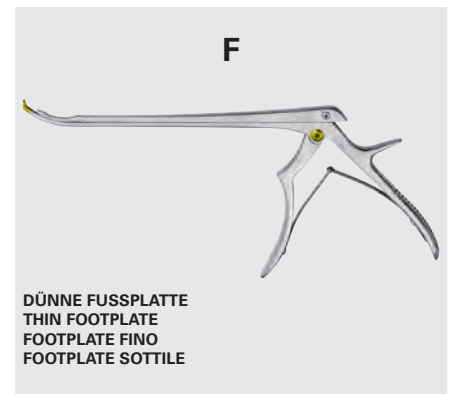
2,0 mm	180 mm, 7"	<b>40-024-02</b>	<b>40-025-02</b>
3,0 mm	180 mm, 7"	<b>40-024-03</b>	<b>40-025-03</b>
4,0 mm	180 mm, 7"	<b>40-024-04</b>	<b>40-025-04</b>
5,0 mm	180 mm, 7"	<b>40-024-05</b>	
2,0 mm	200 mm, 8"	<b>40-024-12</b>	<b>40-025-12</b>
3,0 mm	200 mm, 8"	<b>40-024-13</b>	<b>40-025-13</b>
4,0 mm	200 mm, 8"	<b>40-024-14</b>	<b>40-025-14</b>
5,0 mm	200 mm, 8"	<b>40-024-15</b>	

Weitere Längen auf Anfrage  
Other lengths on request  
Otras longitudes bajo pedido  
Ulteriori lunghezze su richiesta

STEEL  
STAINLESS



Für **DÜNNE FUSSPLATTE** fügen Sie ein "F" hinter die Artikelnummer  
For **THIN FOOTPLATE** please add "F" behind the item number  
Para el **FOOTPLATE FINO** agregue por favor "F" detrás del número del artículo  
Per **FOOTPLATE SOTTILE** aggiunga prego la "F" dietro il numero dell'articolo



**DÜNNE FUSSPLATTE**  
**THIN FOOTPLATE**  
**FOOTPLATE FINO**  
**FOOTPLATE SOTTILE**



## KERRISON

L



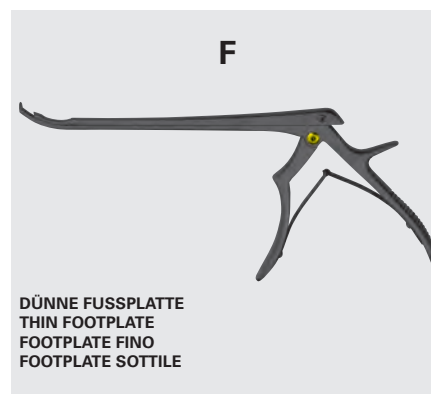
Bissbreite	Schaftlänge	40° nach oben	40° nach unten
Width of bite	Length of shaft	40° upwards	40° downwards
Ancura de la boca	Longitud del vástago	40° hacia arriba	40° hacia abajo
Larghezza del morso	Lunghezza dell'asta	40° verso l'alto	40° verso il basso

2,0 mm	180 mm, 7 "	<b>40-024-02 B</b>	<b>40-025-02 B</b>
3,0 mm	180 mm, 7 "	<b>40-024-03 B</b>	<b>40-025-03 B</b>
4,0 mm	180 mm, 7 "	<b>40-024-04 B</b>	<b>40-025-04 B</b>
5,0 mm	180 mm, 7 "	<b>40-024-05 B</b>	
2,0 mm	200 mm, 8 "	<b>40-024-12 B</b>	<b>40-025-12 B</b>
3,0 mm	200 mm, 8 "	<b>40-024-13 B</b>	<b>40-025-13 B</b>
4,0 mm	200 mm, 8 "	<b>40-024-14 B</b>	<b>40-025-14 B</b>
5,0 mm	200 mm, 8 "	<b>40-024-15 B</b>	

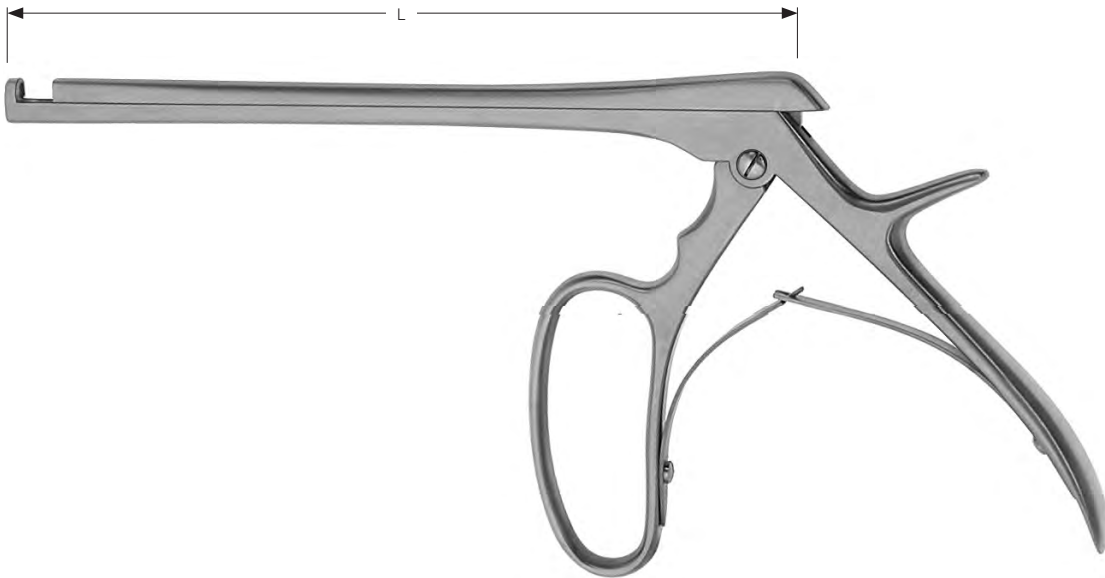
Weitere Längen auf Anfrage  
Other lengths on request  
Otras longitudes bajo pedido  
Ulteriori lunghezze su richiesta



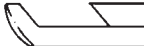

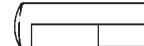
Für **DÜNNE FUSSPLATTE** fügen Sie ein "F" hinter die Artikelnummer  
For **THIN FOOTPLATE** please add "F" behind the item number  
Para el **FOOTPLATE FINO** agregue por favor "F" detrás del número del artículo  
Per **FOOTPLATE SOTTILE** aggiunga prego la "F" dietro il numero dell'articolo



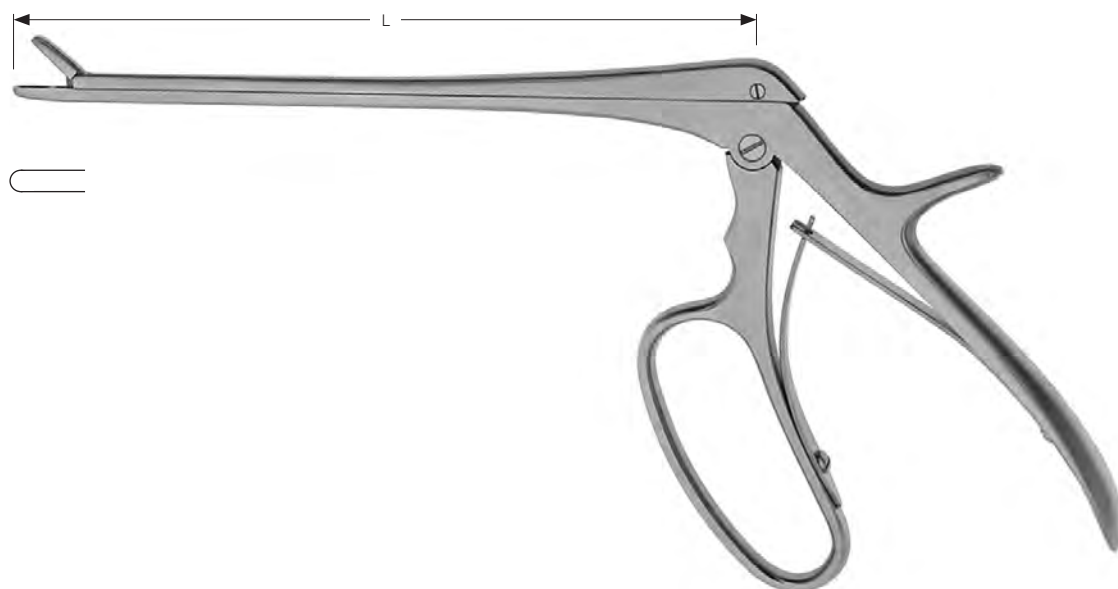
**DÜNNE FUSSPLATTE**  
**THIN FOOTPLATE**  
**FOOTPLATE FINO**  
**FOOTPLATE SOTTILE**



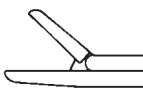
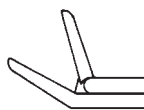
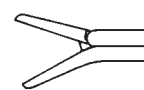
**FERRIS-SMITH-KERRISON**

	L			
Bissbreite	Schaftlänge	40° nach oben	90° nach oben	90° nach unten
Width of bite	Length of shaft	40° upwards	90° upwards	90° downwards
Ancura de la boca	Longitud del vástago	40° hacia arriba	90° hacia arriba	90° hacia abajo
Larghezza del morso	Lunghezza dell'asta	40° verso l'alto	90° verso l'alto	90° il basso
3,0 mm	180 mm, 7"	<b>40-027-23</b>	<b>40-027-03</b>	<b>40-027-13</b>
5,0 mm	180 mm, 7"	<b>40-027-25</b>	<b>40-027-05</b>	<b>40-027-15</b>

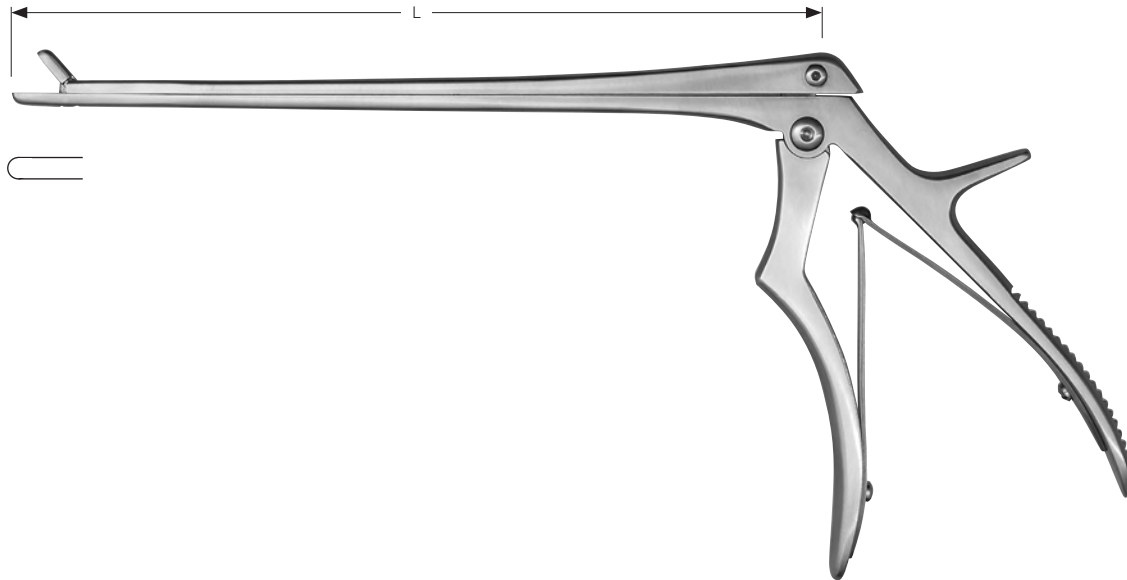
Weitere Längen auf Anfrage  
Other lengths on request  
Otras longitudes bajo pedido  
Ulteriori lunghezze su richiesta



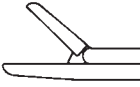
## FERRIS-SMITH-CUSHING

	L			
Bissbreite Width of bite Ancura de la boca Larghezza del morso	Schaftlänge Length of shaft Longitud del vástago Lunghezza dell'asta	gerade straight recta retta	aufgebogen 30° curved up 30° curva hacia arriba 30° curva verso l'alto 30°	abwärts gebogen 30° curved down 30° curva hacia abajo 30° curva verso il basso 30°
2,0 x 10,0 mm	180 mm, 7"	<b>40-028-02</b>	<b>40-028-12</b>	<b>40-028-22</b>
3,0 x 10,0 mm	180 mm, 7"	<b>40-028-03</b>	<b>40-028-13</b>	<b>40-028-23</b>
4,0 x 10,0 mm	180 mm, 7"	<b>40-028-04</b>	<b>40-028-14</b>	<b>40-028-24</b>
5,0 x 10,0 mm	180 mm, 7"	<b>40-028-05</b>	<b>40-028-15</b>	<b>40-028-25</b>
6,0 x 10,0 mm	180 mm, 7"	<b>40-028-06</b>	<b>40-028-16</b>	<b>40-028-26</b>

Weitere Längen auf Anfrage  
 Other lengths on request  
 Otras longitudes bajo pedido  
 Ulteriori lunghezze su richiesta



## FERRIS-SMITH-CUSHING

	L		
Bissbreite Width of bite Ancura de la boca Larghezza del morso	Schaftlänge Length of shaft Longitud del vástago Lunghezza dell'asta	gerade straight recta retta	aufgebogen 30° curved up 30° curva hacia arriba 30° curva verso l'alto 30°
2,0 x 10,0 mm	180 mm, 7"	<b>40-028-32</b>	<b>40-028-42</b>
3,0 x 10,0 mm	180 mm, 7"	<b>40-028-33</b>	<b>40-028-43</b>
4,0 x 10,0 mm	180 mm, 7"	<b>40-028-34</b>	<b>40-028-44</b>
5,0 x 10,0 mm	180 mm, 7"	<b>40-028-35</b>	<b>40-028-45</b>
6,0 x 10,0 mm	180 mm, 7"	<b>40-028-36</b>	<b>40-028-46</b>
2,0 x 10,0 mm	200 mm, 8"	<b>40-028-52</b>	<b>40-028-62</b>
3,0 x 10,0 mm	200 mm, 8"	<b>40-028-53</b>	<b>40-028-63</b>
4,0 x 10,0 mm	200 mm, 8"	<b>40-028-54</b>	<b>40-028-64</b>
5,0 x 10,0 mm	200 mm, 8"	<b>40-028-55</b>	<b>40-028-65</b>
6,0 x 10,0 mm	200 mm, 8"	<b>40-028-56</b>	<b>40-028-66</b>
2,0 x 10,0 mm	230 mm, 9"	<b>40-028-72</b>	<b>40-028-82</b>
3,0 x 10,0 mm	230 mm, 9"	<b>40-028-73</b>	<b>40-028-83</b>
4,0 x 10,0 mm	230 mm, 9"	<b>40-028-74</b>	<b>40-028-84</b>
5,0 x 10,0 mm	230 mm, 9"	<b>40-028-75</b>	<b>40-028-85</b>
6,0 x 10,0 mm	230 mm, 9"	<b>40-028-76</b>	<b>40-028-86</b>

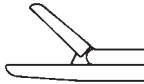
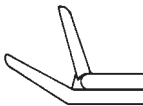
Weitere Längen auf Anfrage  
Other lengths on request  
Otras longitudes bajo pedido  
Ulteriori lunghezze su richiesta

Laminektomie-Zangen, zerlegbar  
 Laminectomy rongeurs, detachable  
 Pinzas cortantes para laminectomía, desmontable  
 Pinze per laminectomia, smontabile

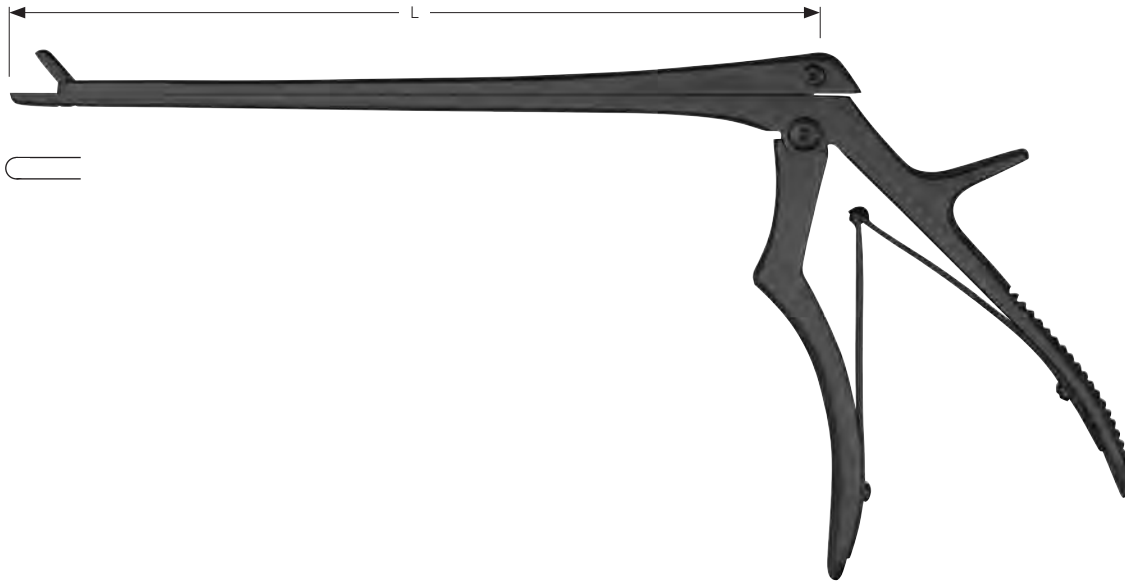


STEEL  
STAINLESS

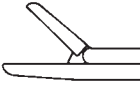
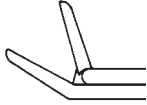
## FERRIS-SMITH-CUSHING

	L		
Bissbreite Width of bite Ancura de la boca Larghezza del morso	Schaftlänge Length of shaft Longitud del vástago Lunghezza dell'asta	gerade straight recta retta	aufgebogen 30° curved up 30° curva hacia arriba 30° curva verso l'alto 30°
2,0 x 10,0 mm	180 mm, 7 "	<b>40-028-32 Z</b>	<b>40-028-42 Z</b>
3,0 x 10,0 mm	180 mm, 7 "	<b>40-028-33 Z</b>	<b>40-028-43 Z</b>
4,0 x 10,0 mm	180 mm, 7 "	<b>40-028-34 Z</b>	<b>40-028-44 Z</b>
5,0 x 10,0 mm	180 mm, 7 "	<b>40-028-35 Z</b>	<b>40-028-45 Z</b>
6,0 x 10,0 mm	180 mm, 7 "	<b>40-028-36 Z</b>	<b>40-028-46 Z</b>
2,0 x 10,0 mm	200 mm, 8 "	<b>40-028-52 Z</b>	<b>40-028-62 Z</b>
3,0 x 10,0 mm	200 mm, 8 "	<b>40-028-53 Z</b>	<b>40-028-63 Z</b>
4,0 x 10,0 mm	200 mm, 8 "	<b>40-028-54 Z</b>	<b>40-028-64 Z</b>
5,0 x 10,0 mm	200 mm, 8 "	<b>40-028-55 Z</b>	<b>40-028-65 Z</b>
6,0 x 10,0 mm	200 mm, 8 "	<b>40-028-56 Z</b>	<b>40-028-66 Z</b>
2,0 x 10,0 mm	230 mm, 9 "	<b>40-028-72 Z</b>	<b>40-028-82 Z</b>
3,0 x 10,0 mm	230 mm, 9 "	<b>40-028-73 Z</b>	<b>40-028-83 Z</b>
4,0 x 10,0 mm	230 mm, 9 "	<b>40-028-74 Z</b>	<b>40-028-84 Z</b>
5,0 x 10,0 mm	230 mm, 9 "	<b>40-028-75 Z</b>	<b>40-028-85 Z</b>
6,0 x 10,0 mm	230 mm, 9 "	<b>40-028-76 Z</b>	<b>40-028-86 Z</b>

Weitere Längen auf Anfrage  
 Other lengths on request  
 Otras longitudes bajo pedido  
 Ulteriori lunghezze su richiesta



## FERRIS-SMITH-CUSHING

	L		
Bissbreite Width of bite Ancura de la boca Larghezza del morso	Schaftlänge Length of shaft Longitud del vástago Lunghezza dell'asta	gerade straight recta retta	aufgebogen 30° curved up 30° curva hacia arriba 30° curva verso l'alto 30°
2,0 x 10,0 mm	180 mm, 7"	<b>40-028-32 B</b>	<b>40-028-42 B</b>
3,0 x 10,0 mm	180 mm, 7"	<b>40-028-33 B</b>	<b>40-028-43 B</b>
4,0 x 10,0 mm	180 mm, 7"	<b>40-028-34 B</b>	<b>40-028-44 B</b>
5,0 x 10,0 mm	180 mm, 7"	<b>40-028-35 B</b>	<b>40-028-45 B</b>
6,0 x 10,0 mm	180 mm, 7"	<b>40-028-36 B</b>	<b>40-028-46 B</b>
2,0 x 10,0 mm	200 mm, 8"	<b>40-028-52 B</b>	<b>40-028-62 B</b>
3,0 x 10,0 mm	200 mm, 8"	<b>40-028-53 B</b>	<b>40-028-63 B</b>
4,0 x 10,0 mm	200 mm, 8"	<b>40-028-54 B</b>	<b>40-028-64 B</b>
5,0 x 10,0 mm	200 mm, 8"	<b>40-028-55 B</b>	<b>40-028-65 B</b>
6,0 x 10,0 mm	200 mm, 8"	<b>40-028-56 B</b>	<b>40-028-66 B</b>
2,0 x 10,0 mm	230 mm, 9"	<b>40-028-72 B</b>	<b>40-028-82 B</b>
3,0 x 10,0 mm	230 mm, 9"	<b>40-028-73 B</b>	<b>40-028-83 B</b>
4,0 x 10,0 mm	230 mm, 9"	<b>40-028-74 B</b>	<b>40-028-84 B</b>
5,0 x 10,0 mm	230 mm, 9"	<b>40-028-75 B</b>	<b>40-028-85 B</b>
6,0 x 10,0 mm	230 mm, 9"	<b>40-028-76 B</b>	<b>40-028-86 B</b>

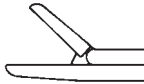
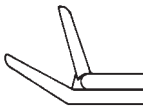
Weitere Längen auf Anfrage  
Other lengths on request  
Otras longitudes bajo pedido  
Ulteriori lunghezze su richiesta



Laminektomie-Zangen, zerlegbar  
 Laminectomy rongeurs, detachable  
 Pinzas cortantes para laminectomía, desmontable  
 Pinze per laminectomia, smontabile



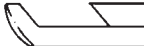

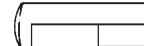
## FERRIS-SMITH-CUSHING

	L		
Bissbreite Width of bite Ancura de la boca Larghezza del morso	Schaftlänge Length of shaft Longitud del vástago Lunghezza dell'asta	gerade straight recta retta	aufgebogen 30° curved up 30° curva hacia arriba 30° curva verso l'alto 30°
2,0 x 10,0 mm	180 mm, 7 "	<b>40-028-32 ZB</b>	<b>40-028-42 ZB</b>
3,0 x 10,0 mm	180 mm, 7 "	<b>40-028-33 ZB</b>	<b>40-028-43 ZB</b>
4,0 x 10,0 mm	180 mm, 7 "	<b>40-028-34 ZB</b>	<b>40-028-44 ZB</b>
5,0 x 10,0 mm	180 mm, 7 "	<b>40-028-35 ZB</b>	<b>40-028-45 ZB</b>
6,0 x 10,0 mm	180 mm, 7 "	<b>40-028-36 ZB</b>	<b>40-028-46 ZB</b>
2,0 x 10,0 mm	200 mm, 8 "	<b>40-028-52 ZB</b>	<b>40-028-62 ZB</b>
3,0 x 10,0 mm	200 mm, 8 "	<b>40-028-53 ZB</b>	<b>40-028-63 ZB</b>
4,0 x 10,0 mm	200 mm, 8 "	<b>40-028-54 ZB</b>	<b>40-028-64 ZB</b>
5,0 x 10,0 mm	200 mm, 8 "	<b>40-028-55 ZB</b>	<b>40-028-65 ZB</b>
6,0 x 10,0 mm	200 mm, 8 "	<b>40-028-56 ZB</b>	<b>40-028-66 ZB</b>
2,0 x 10,0 mm	230 mm, 9 "	<b>40-028-72 ZB</b>	<b>40-028-82 ZB</b>
3,0 x 10,0 mm	230 mm, 9 "	<b>40-028-73 ZB</b>	<b>40-028-83 ZB</b>
4,0 x 10,0 mm	230 mm, 9 "	<b>40-028-74 ZB</b>	<b>40-028-84 ZB</b>
5,0 x 10,0 mm	230 mm, 9 "	<b>40-028-75 ZB</b>	<b>40-028-85 ZB</b>
6,0 x 10,0 mm	230 mm, 9 "	<b>40-028-76 ZB</b>	<b>40-028-86 ZB</b>

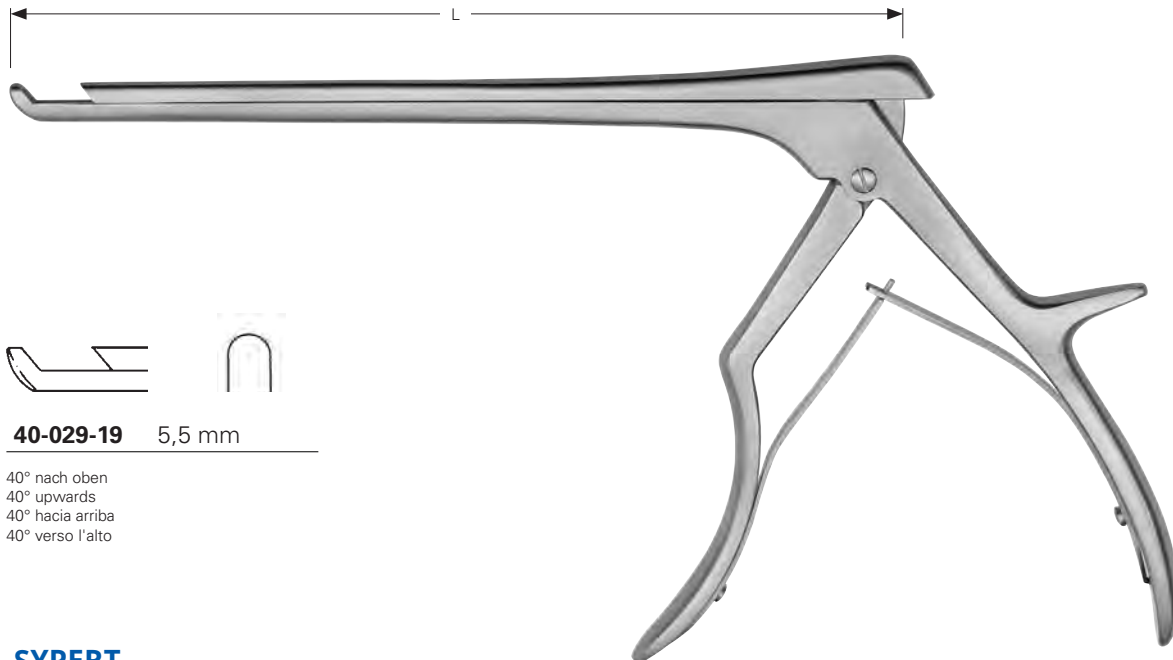
Weitere Längen auf Anfrage  
 Other lengths on request  
 Otras longitudes bajo pedido  
 Ulteriori lunghezze su richiesta



## COLCLOUGH

	L			
Bissbreite Width of bite Ancura de la boca Larghezza del morso	Schaftlänge Length of shaft Longitud del vástago Lunghezza dell'asta	40° nach oben 40° upwards 40° hacia arriba 40° verso l'alto	90° nach oben 90° upwards 90° hacia arriba 90° verso l'alto	90° nach unten 90° downwards 90° hacia abajo 90° il basso
3,0 mm	150 mm, 6"	<b>40-029-03</b>	<b>40-029-01</b>	<b>40-029-53</b>
5,0 mm	150 mm, 6"	<b>40-029-05</b>	<b>40-029-02</b>	<b>40-029-55</b>
2,0 mm	200 mm, 8"	<b>40-029-12</b>	<b>40-029-22</b>	<b>40-029-62</b>
3,0 mm	200 mm, 8"	<b>40-029-13</b>	<b>40-029-23</b>	<b>40-029-63</b>
4,0 mm	200 mm, 8"	<b>40-029-14</b>	<b>40-029-24</b>	<b>40-029-64</b>
5,0 mm	200 mm, 8"	<b>40-029-15</b>	<b>40-029-25</b>	<b>40-029-65</b>

Weitere Längen auf Anfrage  
Other lengths on request  
Otras longitudes bajo pedido  
Ulteriori lunghezze su richiesta



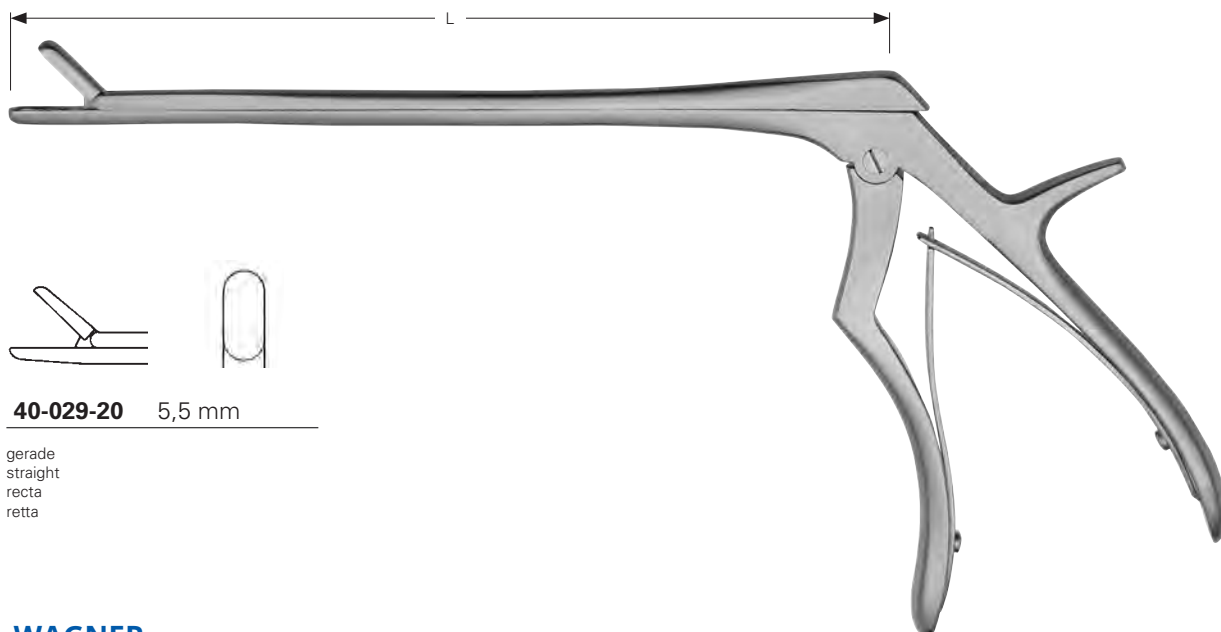
**40-029-19** 5,5 mm

40° nach oben  
40° upwards  
40° hacia arriba  
40° verso l'alto

### SYPERT

**40-029-19** 25,5 cm, 10"

STEEL  
STAINLESS



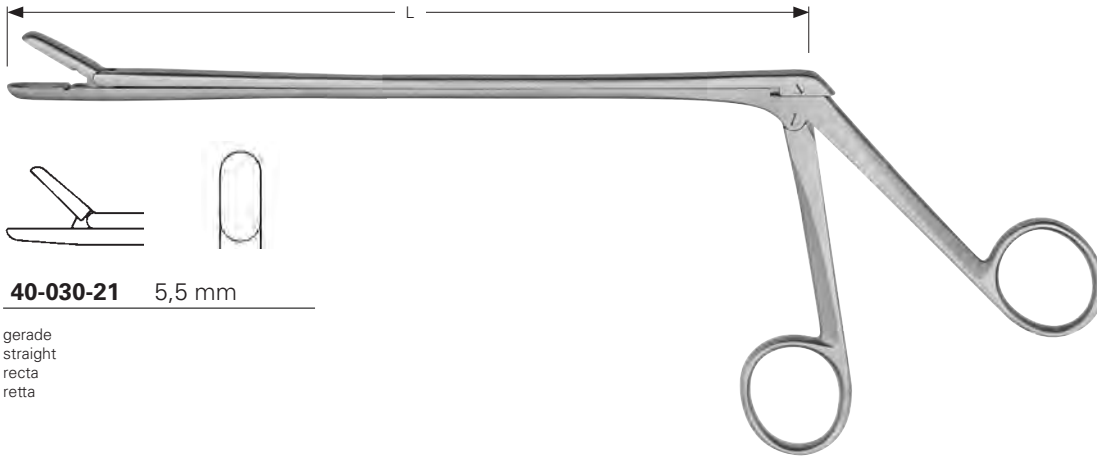
**40-029-20** 5,5 mm

gerade  
straight  
recta  
retta

### WAGNER

**40-029-20** 20,0 cm, 8"

STEEL  
STAINLESS



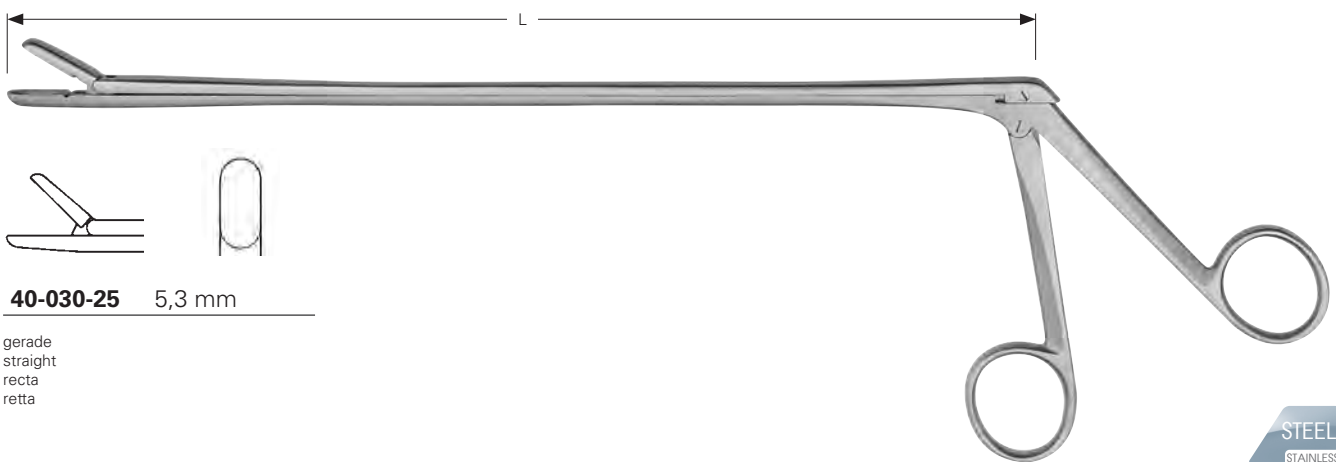
**40-030-21** 5,5 mm

gerade  
 straight  
 recta  
 retta

STEEL  
 STAINLESS

**WAGNER**

**40-030-21** 21,0 cm, 8 ¼"



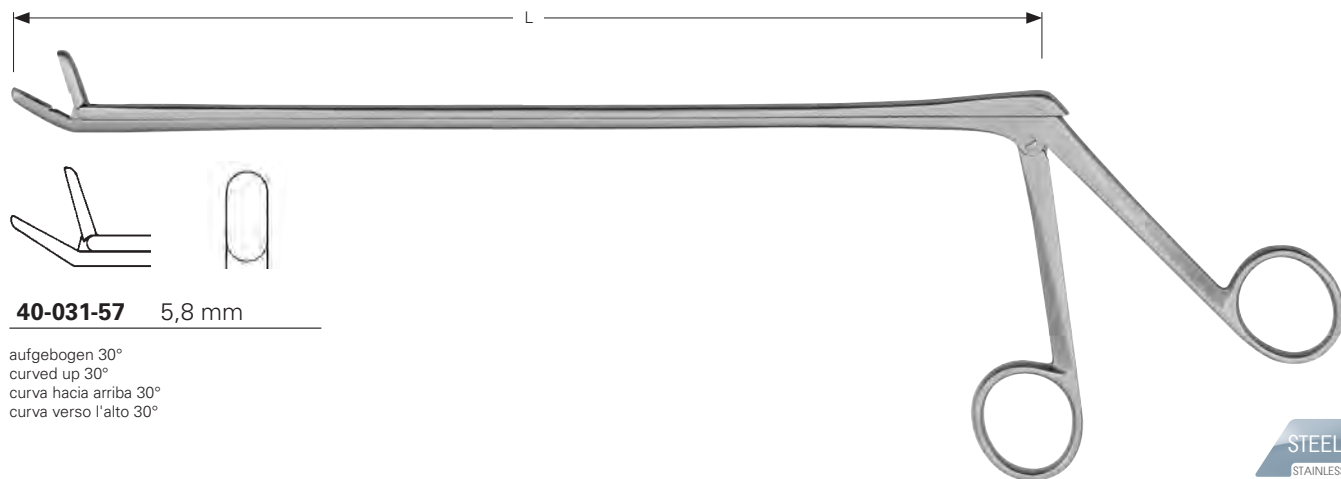
**40-030-25** 5,3 mm

gerade  
 straight  
 recta  
 retta

STEEL  
 STAINLESS

**WAGNER**

**40-030-25** 25,5 cm, 10"



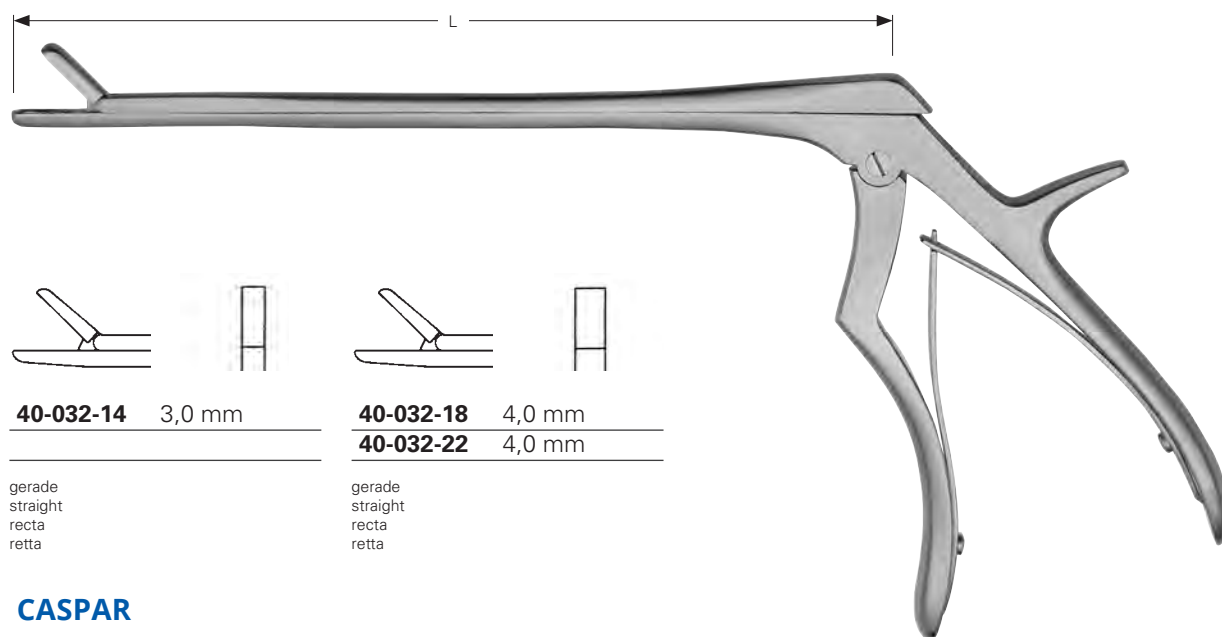
**40-031-57** 5,8 mm

aufgebogen 30°  
 curved up 30°  
 curva hacia arriba 30°  
 curva verso l'alto 30°

STEEL  
 STAINLESS

### SYPERT

**40-031-57** 25,5 cm, 10"



**40-032-14** 3,0 mm

**40-032-18** 4,0 mm

**40-032-22** 4,0 mm

gerade  
 straight  
 recta  
 retta

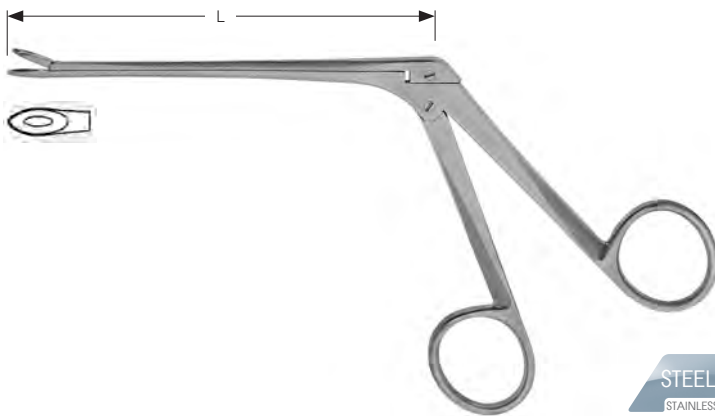
gerade  
 straight  
 recta  
 retta

STEEL  
 STAINLESS




### CASPAR

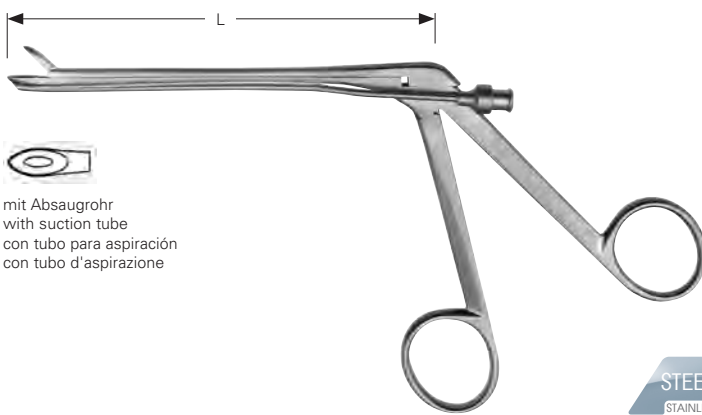
**40-032-14 - 40-032-18** 18,0 cm, 7"

**40-032-22** 22,0 cm, 8 3/4"






**WEIL-BLAKESLEY**

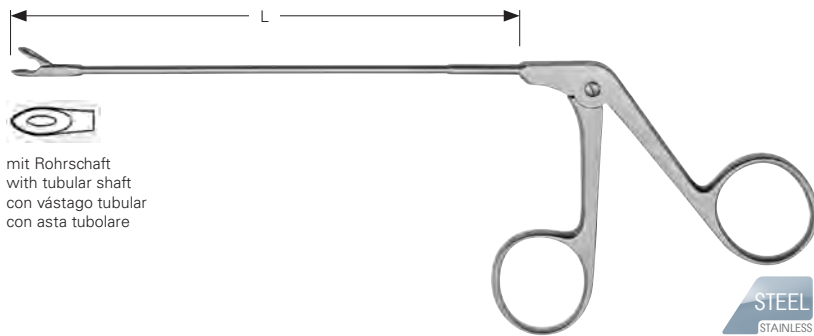
	L			
Bissbreite Width of bite Ancura de la boca Larghezza del morso	Schaftlänge Length of shaft Longitud del vástago Lunghezza dell'asta	gerade straight recta retta	aufgebogen 45° curved up 45° curva hacia arriba 45° curva verso l'alto 45°	aufgebogen 90° curved up 90° curva hacia arriba 90° curva verso l'alto 90°
3,0 mm	120 mm, 4 3/4"	<b>40-036-30</b>	<b>40-037-30</b>	<b>40-038-30</b>
3,6 mm	120 mm, 4 3/4"	<b>40-036-36</b>	<b>40-037-36</b>	<b>40-038-36</b>
4,2 mm	120 mm, 4 3/4"	<b>40-036-42</b>	<b>40-037-42</b>	<b>40-038-42</b>
4,8 mm	120 mm, 4 3/4"	<b>40-036-48</b>	<b>40-037-48</b>	<b>40-038-48</b>
5,2 mm	120 mm, 4 3/4"	<b>40-036-58</b>	<b>40-037-58</b>	<b>40-038-58</b>



mit Absaugrohr  
with suction tube  
con tubo para aspiración  
con tubo d'aspirazione




**WEIL-BLAKESLEY**

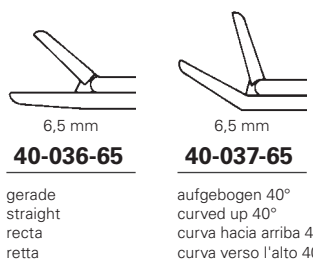
	L			
Bissbreite Width of bite Ancura de la boca Larghezza del morso	Schaftlänge Length of shaft Longitud del vástago Lunghezza dell'asta	gerade straight recta retta	aufgebogen 45° curved up 45° curva hacia arriba 45° curva verso l'alto 45°	aufgebogen 90° curved up 90° curva hacia arriba 90° curva verso l'alto 90°
2,5 mm	120 mm, 4 3/4"	<b>40-036-30 A</b>	<b>40-037-30 A</b>	
3,6 mm	120 mm, 4 3/4"	<b>40-036-36 A</b>	<b>40-037-36 A</b>	<b>40-038-36 A</b>
4,8 mm	120 mm, 4 3/4"	<b>40-036-48 A</b>	<b>40-037-48 A</b>	



mit Rohrschaft  
 with tubular shaft  
 con vástago tubular  
 con asta tubolare

### WEIL-BLAKESLEY

	L			
Bissbreite Width of bite Ancura de la boca Larghezza del morso	Schaftlänge Length of shaft Longitud del vástago Lunghhezza dell'asta	gerade straight recta retta	aufgebogen 45° curved up 45° curva hacia arriba 45° curva verso l'alto 45°	aufgebogen 90° curved up 90° curva hacia arriba 90° curva verso l'alto 90°
3,0 mm	130 mm, 5 "	<b>40-036-30 R</b>	<b>40-037-30 R</b>	
3,6 mm	130 mm, 5 "	<b>40-036-36 R</b>	<b>40-037-36 R</b>	<b>40-038-36 R</b>
4,2 mm	130 mm, 5 "	<b>40-036-42 R</b>	<b>40-037-42 R</b>	<b>40-038-42 R</b>
4,8 mm	130 mm, 5 "	<b>40-036-48 R</b>	<b>40-037-48 R</b>	<b>40-038-48 R</b>
3,0 mm	170 mm, 6 ¾ "	<b>40-036-30 RL</b>	<b>40-037-30 RL</b>	
3,6 mm	170 mm, 6 ¾ "	<b>40-036-36 RL</b>	<b>40-037-36 RL</b>	

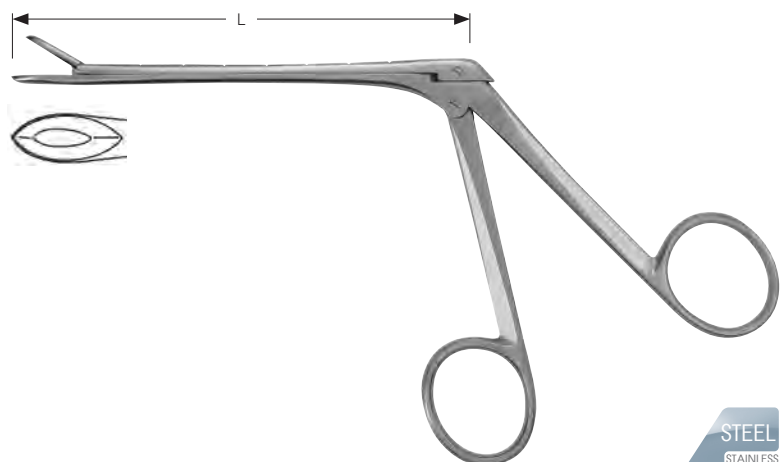


gerade  
 straight  
 recta  
 retta

aufgebogen 40°  
 curved up 40°  
 curva hacia arriba 40°  
 curva verso l'alto 40°

### TILLEY-HENCKEL

**40-036-65 - 40-037-65** 10,0 cm, 4 "



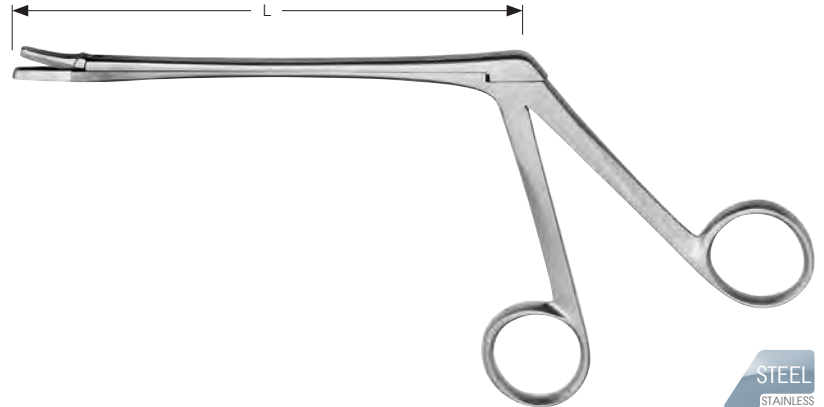


**40-038-00** 1,0 mm  
**40-038-01** 1,5 mm

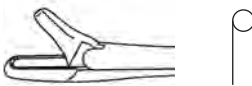
gerade, durchschneidend  
straight, through cutting  
recta, cortantes  
retta, taglienti

### STRUYKEN

**40-038-00 - 40-038-01** 12,0 cm, 4 3/4"



STEEL  
STAINLESS

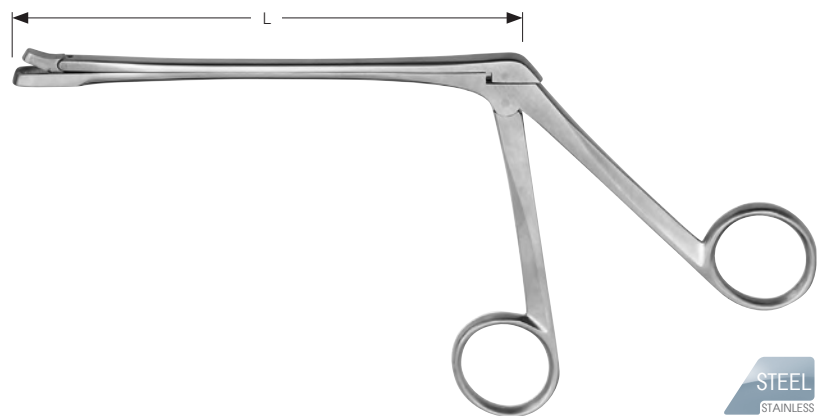


**40-038-02** 2,0 mm  
**40-038-03** 3,0 mm  
**40-038-04** 4,0 mm

gerade, durchschneidend  
straight, through cutting  
recta, cortantes  
retta, taglienti

### MYLES

**40-038-02 - 40-038-04** 12,0 cm, 4 3/4"



STEEL  
STAINLESS

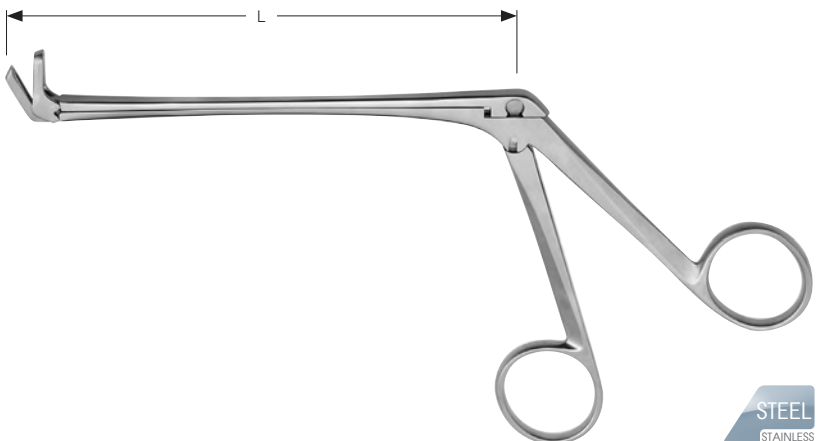


**40-038-11** 3,0 mm

aufgebogen 60°, durchschneidend  
curved up 60°, through cutting  
curva hacia arriba 60°, cortantes  
curva verso l'alto 60°, taglienti

### FRY

**40-038-11** 11,5 cm, 4 1/2"



STEEL  
STAINLESS



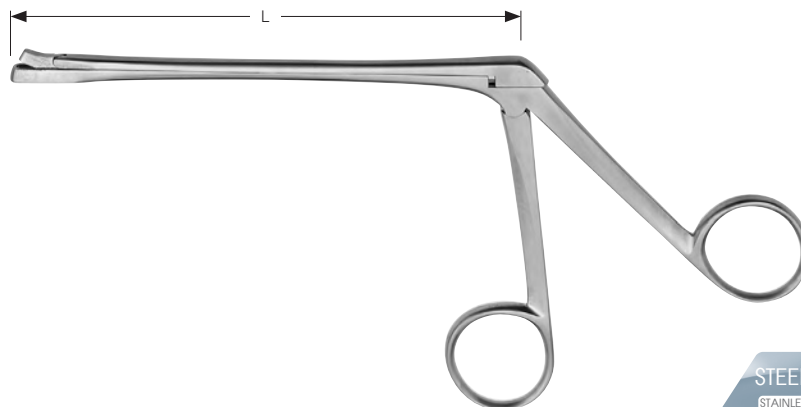


**40-038-12** 2,5 mm  
**40-038-13** 3,0 mm

gerade, durchschneidend  
 straight, through cutting  
 recta, cortantes  
 retta, taglienti

### GRUENWALD-HENKE

**40-038-12 - 40-038-13** 11,0 cm, 4 3/8 "

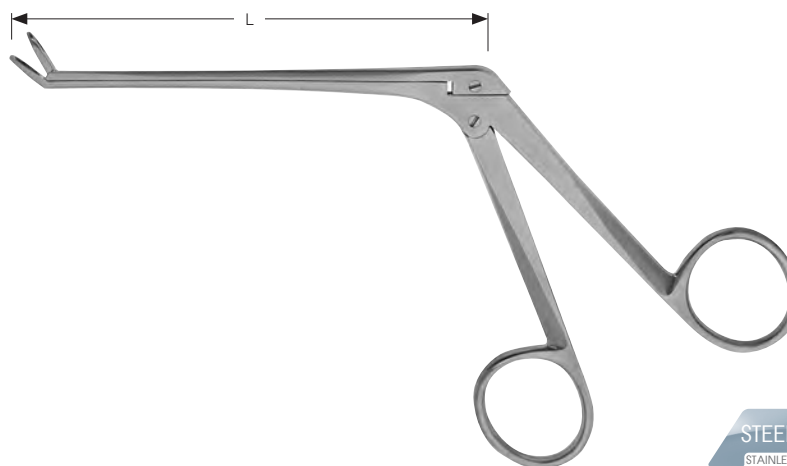


**40-038-60** 6,0 x 14,0 mm

aufgebogen 60°  
 curved up 60°  
 curva hacia arriba 60°  
 curva verso l'alto 60°

### BLAKESLEY-WIGAND

**40-038-60** 11,0 cm, 4 3/8 "

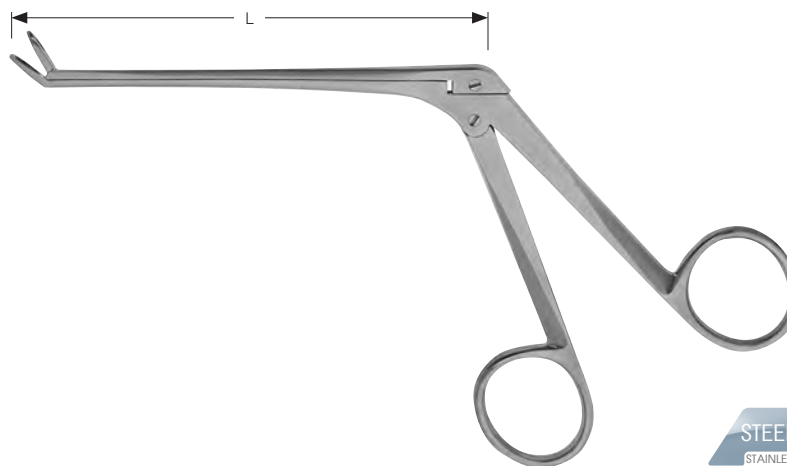


**40-039-25** 2,5 mm

aufgebogen 45°  
 curved up 45°  
 curva hacia arriba 45°  
 curva verso l'alto 45°

### HAJEK

**40-039-25** 12,0 cm, 4 3/4 "



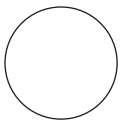
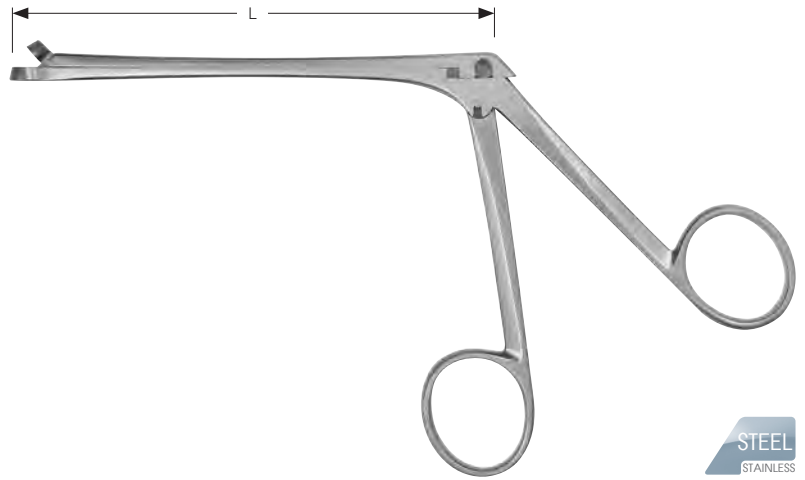


<b>40-040-05</b>	5,0 mm
<b>40-040-07</b>	7,0 mm
<b>40-040-09</b>	9,0 mm
<b>40-040-11</b>	11,0 mm

gerade, durchschneidend  
straight, through cutting  
recta, cortantes  
retta, taglienti

**HARTMANN**

**40-040-05 - 40-040-11** 12,0 cm, 4 3/4"

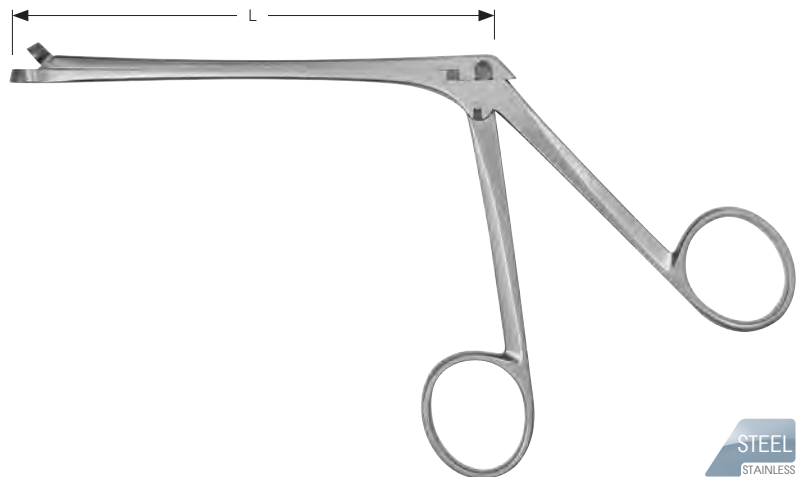


<b>40-040-13</b>	13,0 mm
<b>40-040-15</b>	15,0 mm
<b>40-040-17</b>	17,0 mm

gerade, durchschneidend  
straight, through cutting  
recta, cortantes  
retta, taglienti

**HARTMANN**

**40-040-13 - 40-040-17** 12,0 cm, 4 3/4"

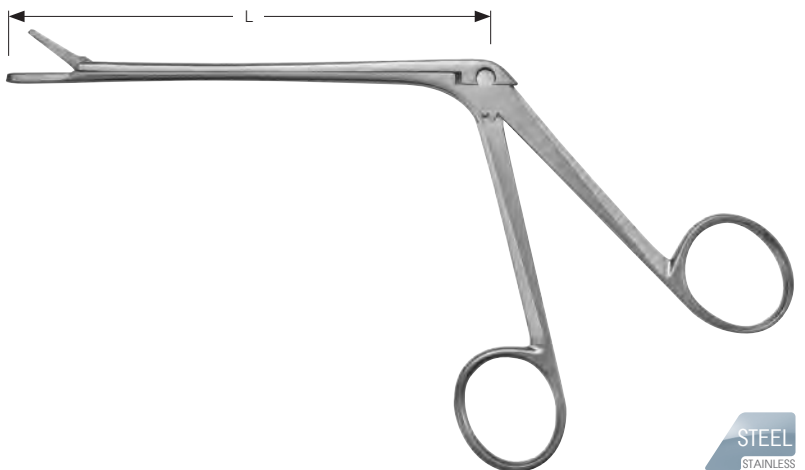


<b>40-041-11</b>	11,0 mm
<b>40-041-12</b>	12,0 mm
<b>40-041-13</b>	13,0 mm

gerade, durchschneidend  
straight, through cutting  
recta, cortantes  
retta, taglienti

**SCHMEDEN**

**40-041-11 - 40-041-13** 12,0 cm, 4 3/4"

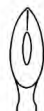




Ø 7,0 mm

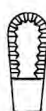
**40-042-01**

gerade  
straight  
recta  
retta



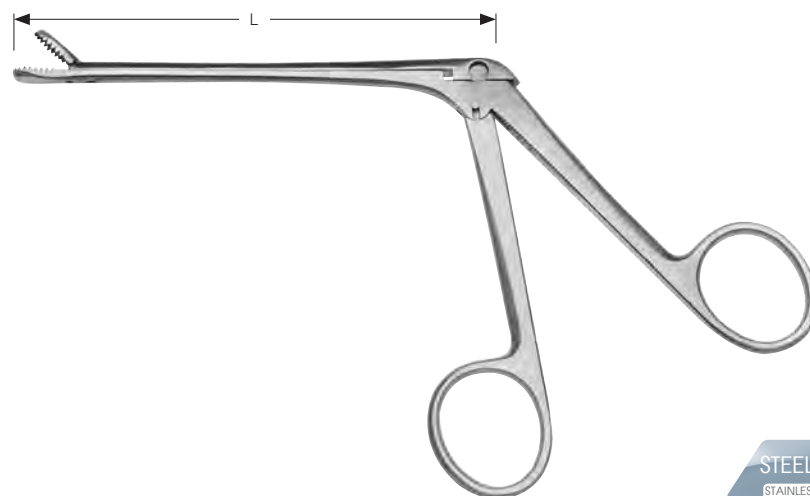
**40-042-02**

gerade  
straight  
recta  
retta



**40-042-03**

gerade  
straight  
recta  
retta



STEEL  
STAINLESS

### WATSON-WILLIAMS

**40-042-01 - 40-042-03** 12,0 cm, 4 ¾ "

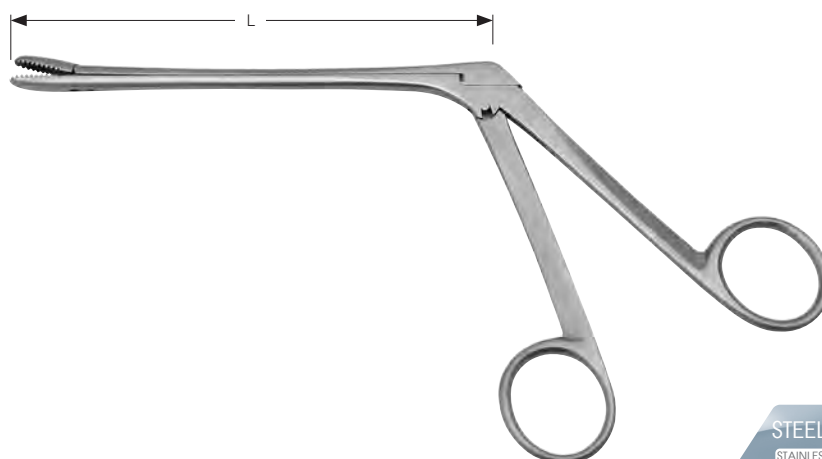


**40-042-04** 5,0 mm

**40-042-05** 7,0 mm

**40-042-06** 9,0 mm

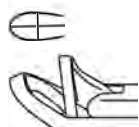
gerade  
straight  
recta  
retta



STEEL  
STAINLESS

### WATSON-WILLIAMS

**40-042-04 - 40-042-06** 12,0 cm, 4 ¾ "



3,5 mm

**40-042-11**



3,5 mm

**40-042-12**

aufgebogen 45°, durchschneidend  
curved up 45°, through cutting  
curva hacia arriba 45°, cortantes  
curva verso l'alto 45°, taglienti



STEEL  
STAINLESS

### WATSON-WILLIAMS

**40-042-11 - 40-042-12** 12,0 cm, 4 ¾ "

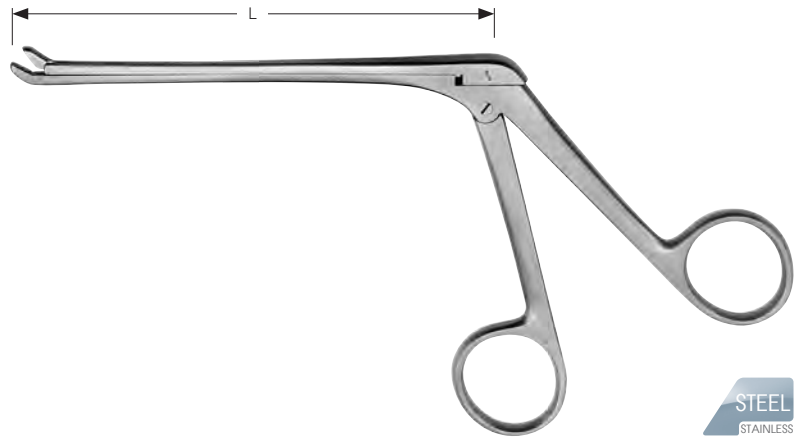


**40-043-01**

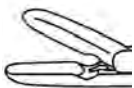
aufgebogen 45°  
 curved up 45°  
 curva hacia arriba 45°  
 curva verso l'alto 45°

**WATSON-WILLIAMS**

**40-043-01** 12,0 cm, 4 3/4"



STEEL  
 STAINLESS



3,0 mm

**40-044-03**

gerade  
 straight  
 recta  
 retta



5,0 mm

**40-044-05**

gerade  
 straight  
 recta  
 retta



3,0 mm

**40-045-03**

aufgebogen 45°  
 curved up 45°  
 curva hacia arriba 45°  
 curva verso l'alto 45°



STEEL  
 STAINLESS

**TAKAHASHI**

**40-044-03 - 40-045-03** 12,0 cm, 4 3/4"



2,0 mm

**40-046-00**

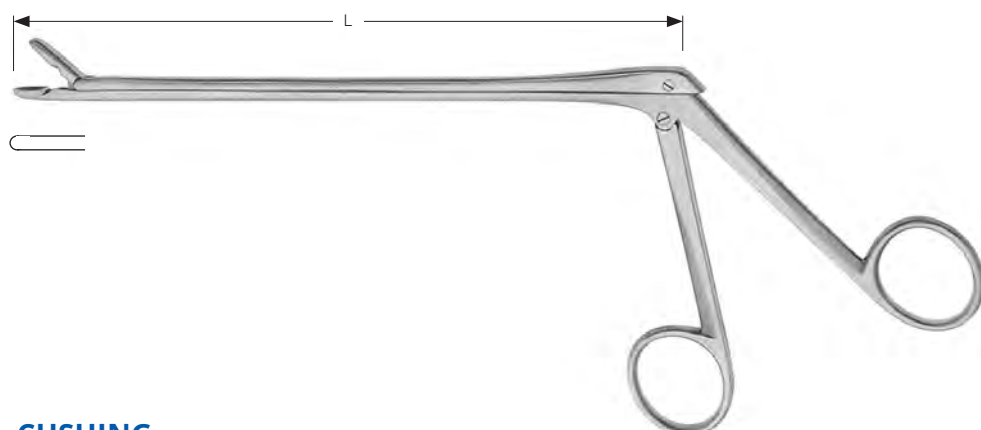
gerade  
 straight  
 recta  
 retta

**BECK**

**40-046-00** 13,0 cm, 5 1/2"



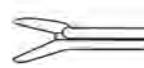


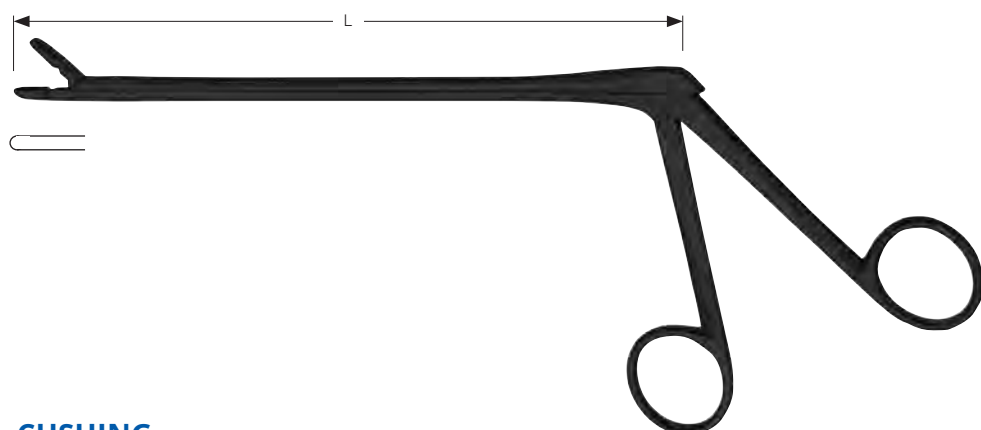
STEEL  
 STAINLESS



STEEL  
STAINLESS



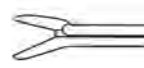
### CUSHING

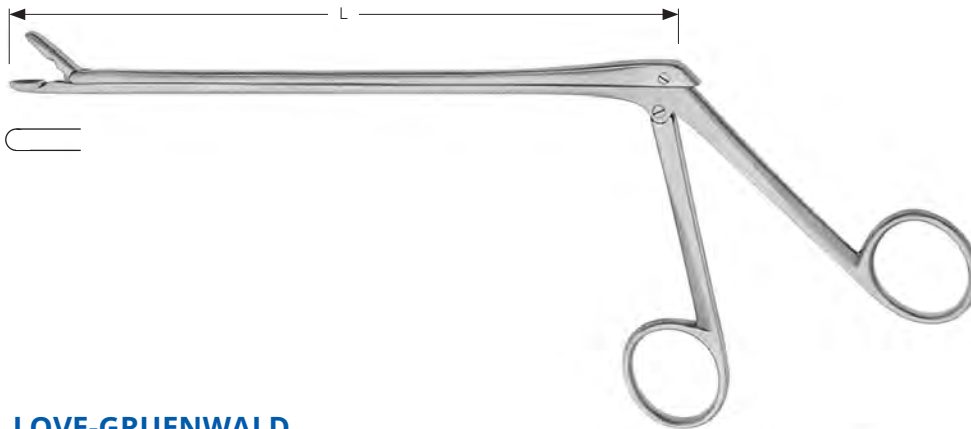
		L		
				
Bissbreite Width of bite Ancura de la boca Larghezza del morso	Schaftlänge Length of shaft Longitud del vástago Lunghezza dell'asta	gerade straight recta retta	aufgebogen 30° curved up 30° curva hacia arriba 30° curva verso l'alto 30°	abwärts gebogen 30° curved down 30° curva hacia abajo 30° curva verso il basso 30°
2,0 x 10,0 mm	130 mm, 5"	<b>40-046-02</b>	<b>40-047-02</b>	<b>40-049-02</b>
2,0 x 10,0 mm	150 mm, 6"	<b>40-050-02</b>	<b>40-051-02</b>	<b>40-053-02</b>
2,0 x 10,0 mm	180 mm, 7"	<b>40-066-02</b>	<b>40-067-02</b>	<b>40-069-02</b>
2,0 x 10,0 mm	200 mm, 8"	<b>40-066-12</b>	<b>40-067-12</b>	<b>40-069-12</b>
2,0 x 10,0 mm	230 mm, 9"	<b>40-066-22</b>		



B  
CERAMIC

### CUSHING

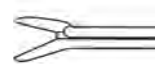
		L		
				
Bissbreite Width of bite Ancura de la boca Larghezza del morso	Schaftlänge Length of shaft Longitud del vástago Lunghezza dell'asta	gerade straight recta retta	aufgebogen 30° curved up 30° curva hacia arriba 30° curva verso l'alto 30°	abwärts gebogen 30° curved down 30° curva hacia abajo 30° curva verso il basso 30°
2,0 x 10,0 mm	130 mm, 5"	<b>40-046-02 B</b>	<b>40-047-02 B</b>	<b>40-049-02 B</b>
2,0 x 10,0 mm	150 mm, 6"	<b>40-050-02 B</b>	<b>40-051-02 B</b>	<b>40-053-02 B</b>
2,0 x 10,0 mm	180 mm, 7"	<b>40-066-02 B</b>	<b>40-067-02 B</b>	<b>40-069-02 B</b>
2,0 x 10,0 mm	200 mm, 8"	<b>40-066-12 B</b>	<b>40-067-12 B</b>	<b>40-069-12 B</b>
2,0 x 10,0 mm	230 mm, 9"	<b>40-066-22 B</b>		



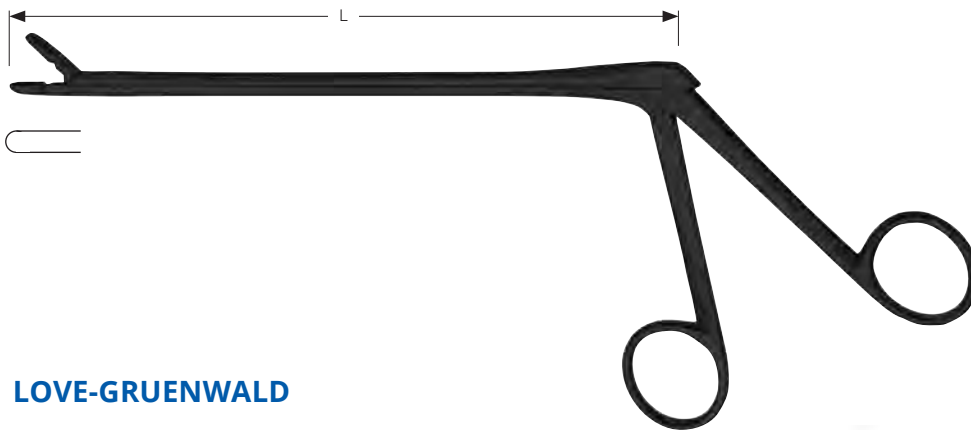
**STEEL**  
STAINLESS

**LOVE-GRUENWALD**

L



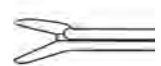
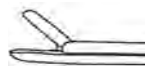
Bissbreite Width of bite Ancura de la boca Larghezza del morso	Schaftlänge Length of shaft Longitud del vástago Lunghezza dell'asta	gerade straight recta retta	aufgebogen 30° curved up 30° curva hacia arriba 30° curva verso l'alto 30°	abwärts gebogen 30° curved down 30° curva hacia abajo 30° curva verso il basso 30°
3,0 x 10,0 mm	130 mm, 5 "	<b>40-046-03</b>	<b>40-047-03</b>	<b>40-049-03</b>
3,0 x 10,0 mm	150 mm, 6 "	<b>40-050-03</b>	<b>40-051-03</b>	<b>40-053-03</b>
3,0 x 10,0 mm	180 mm, 7 "	<b>40-066-03</b>	<b>40-067-03</b>	<b>40-069-03</b>
3,0 x 10,0 mm	200 mm, 8 "	<b>40-066-13</b>	<b>40-067-13</b>	<b>40-069-13</b>
3,0 x 10,0 mm	230 mm, 9 "	<b>40-066-23</b>		



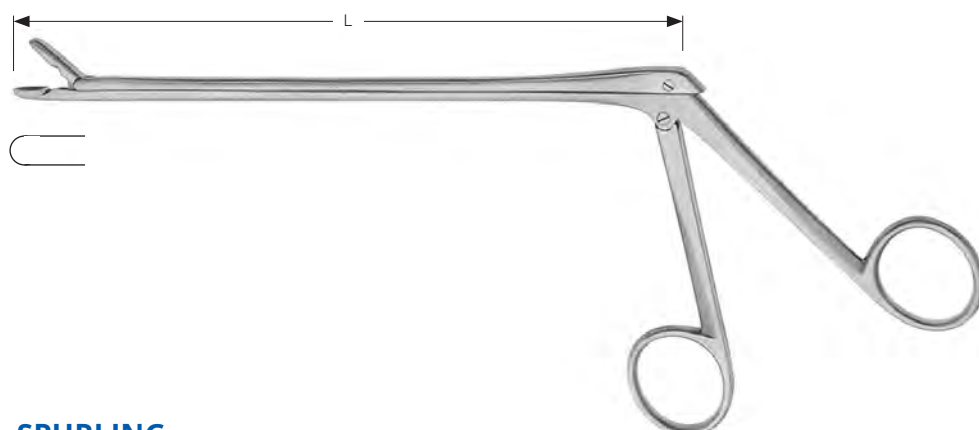
**B**  
GERAMIC

**LOVE-GRUENWALD**

L



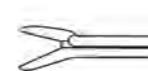
Bissbreite Width of bite Ancura de la boca Larghezza del morso	Schaftlänge Length of shaft Longitud del vástago Lunghezza dell'asta	gerade straight recta retta	aufgebogen 30° curved up 30° curva hacia arriba 30° curva verso l'alto 30°	abwärts gebogen 30° curved down 30° curva hacia abajo 30° curva verso il basso 30°
3,0 x 10,0 mm	130 mm, 5 "	<b>40-046-03 B</b>	<b>40-047-03 B</b>	<b>40-049-03 B</b>
3,0 x 10,0 mm	150 mm, 6 "	<b>40-050-03 B</b>	<b>40-051-03 B</b>	<b>40-053-03 B</b>
3,0 x 10,0 mm	180 mm, 7 "	<b>40-066-03 B</b>	<b>40-067-03 B</b>	<b>40-069-03 B</b>
3,0 x 10,0 mm	200 mm, 8 "	<b>40-066-13 B</b>	<b>40-067-13 B</b>	<b>40-069-13 B</b>
3,0 x 10,0 mm	230 mm, 9 "	<b>40-066-23 B</b>		



STEEL  
STAINLESS

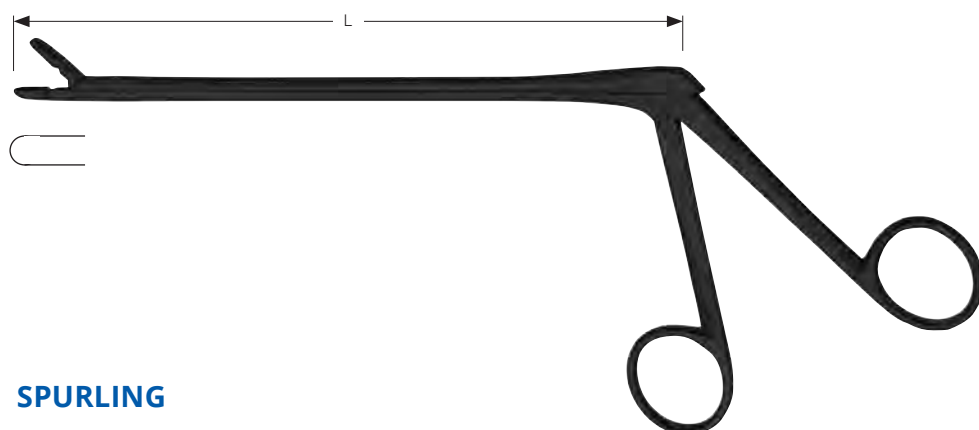
### SPURLING

L



Bissbreite Width of bite Ancura de la boca Larghezza del morso	Schaftlänge Length of shaft Longitud del vástago Lunghezza dell'asta	gerade straight recta retta	aufgebogen 30° curved up 30° curva hacia arriba 30° curva verso l'alto 30°	abwärts gebogen 30° curved down 30° curva hacia abajo 30° curva verso il basso 30°
---	---	--------------------------------------	---	---

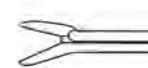
4,0 x 10,0 mm	130 mm, 5 "	<b>40-046-04</b>	<b>40-047-04</b>	<b>40-049-04</b>
4,0 x 10,0 mm	150 mm, 6 "	<b>40-050-04</b>	<b>40-051-04</b>	<b>40-053-04</b>
4,0 x 10,0 mm	180 mm, 7 "	<b>40-066-04</b>	<b>40-067-04</b>	<b>40-069-04</b>
4,0 x 10,0 mm	200 mm, 8 "	<b>40-066-14</b>	<b>40-067-14</b>	<b>40-069-14</b>
4,0 x 10,0 mm	230 mm, 9 "	<b>40-066-24</b>		



B  
CERAMIC

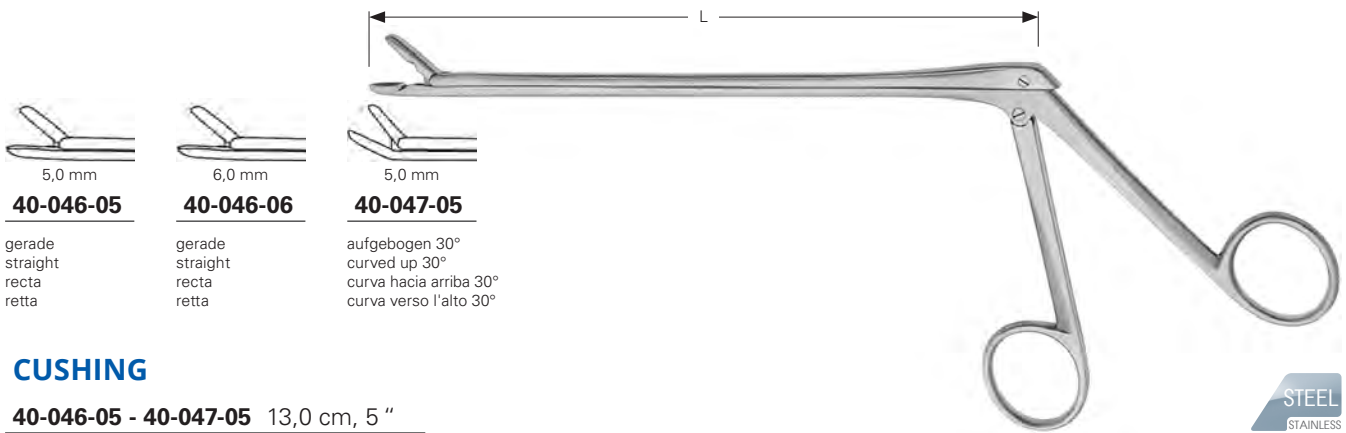
### SPURLING

L



Bissbreite Width of bite Ancura de la boca Larghezza del morso	Schaftlänge Length of shaft Longitud del vástago Lunghezza dell'asta	gerade straight recta retta	aufgebogen 30° curved up 30° curva hacia arriba 30° curva verso l'alto 30°	abwärts gebogen 30° curved down 30° curva hacia abajo 30° curva verso il basso 30°
---	---	--------------------------------------	---	---

4,0 x 10,0 mm	130 mm, 5 "	<b>40-046-04 B</b>	<b>40-047-04 B</b>	<b>40-049-04 B</b>
4,0 x 10,0 mm	150 mm, 6 "	<b>40-050-04 B</b>	<b>40-051-04 B</b>	<b>40-053-04 B</b>
4,0 x 10,0 mm	180 mm, 7 "	<b>40-066-04 B</b>	<b>40-067-04 B</b>	<b>40-069-04 B</b>
4,0 x 10,0 mm	200 mm, 8 "	<b>40-066-14 B</b>	<b>40-067-14 B</b>	<b>40-069-14 B</b>
4,0 x 10,0 mm	230 mm, 9 "	<b>40-066-24 B</b>		



5,0 mm  
**40-046-05**

gerade  
straight  
recta  
retta

6,0 mm  
**40-046-06**

gerade  
straight  
recta  
retta

5,0 mm  
**40-047-05**

aufgebogen 30°  
curved up 30°  
curva hacia arriba 30°  
curva verso l'alto 30°

**CUSHING**

**40-046-05 - 40-047-05** 13,0 cm, 5 "

STEEL  
STAINLESS

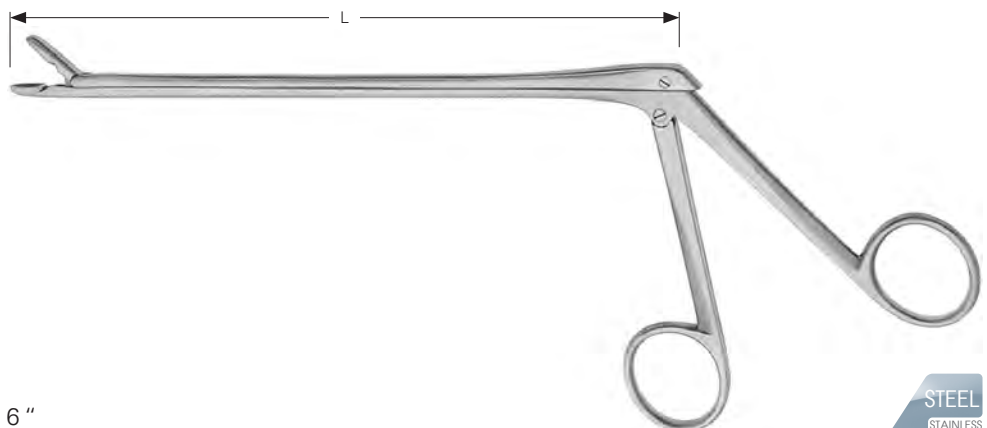


**40-048-02** 2,0 x 3,0 mm  
**40-048-03** 3,0 x 5,0 mm

gerade  
straight  
recta  
retta

**SELVERSTONE**

**40-048-02 - 40-048-03** 15,0 cm, 6 "



STEEL  
STAINLESS



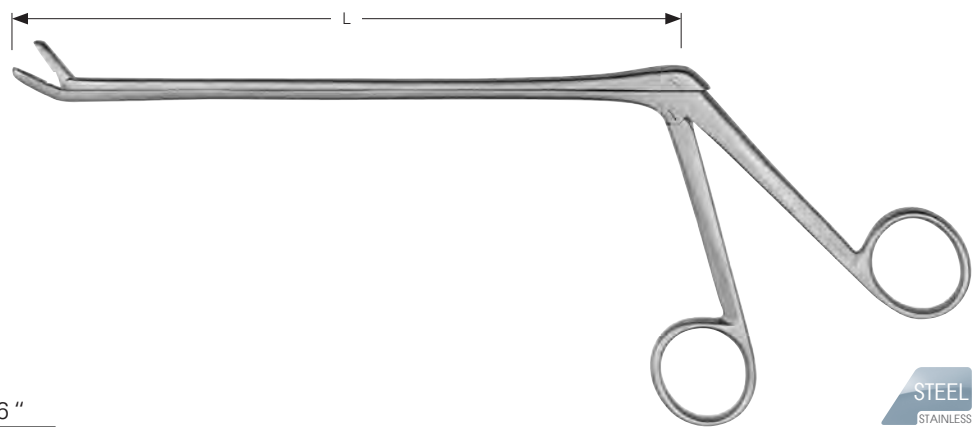


**40-048-12** 2,0 x 10,0 mm  
**40-048-13** 3,0 x 10,0 mm

aufgebogen 30°  
curved up 30°  
curva hacia arriba 30°  
curva verso l'alto 30°

## SELVERSTONE

**40-048-12 - 40-048-13** 15,0 cm, 6"

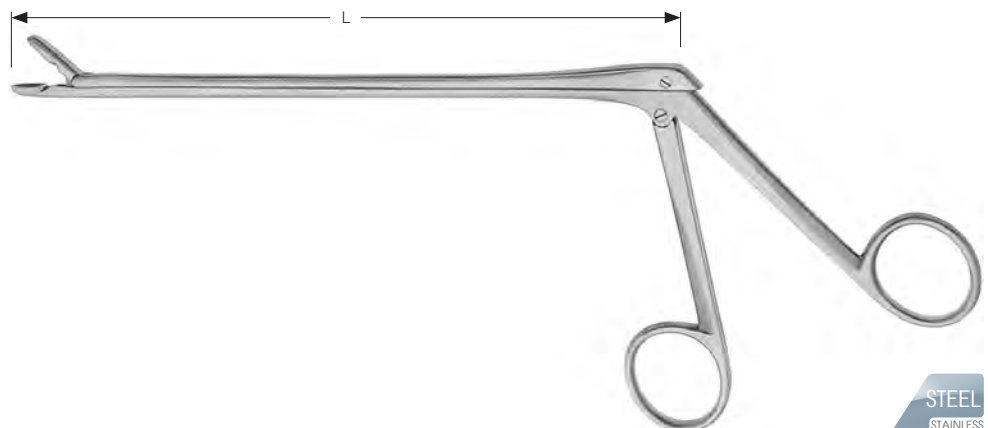


**40-050-05** 5,0 mm

gerade  
straight  
recta  
retta

## CASPAR

**40-050-05** 15,0 cm, 6"






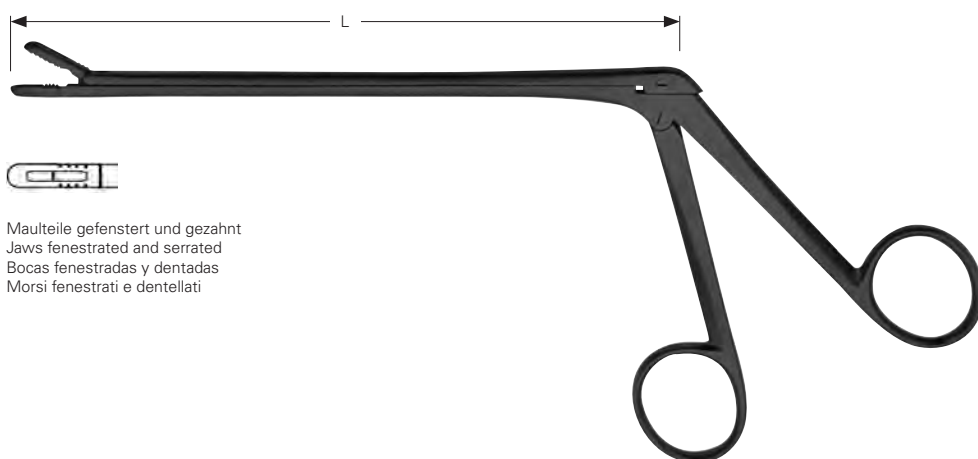


Maulteile gefenestert und gezahnt  
Jaws fenestrated and serrated  
Bocas fenestradas y dentadas  
Morsi fenestrati e dentellati

**STEEL**  
STAINLESS

**CASPAR**

	L			
Bissbreite Width of bite Ancura de la boca Larghezza del morso	Schaftlänge Length of shaft Longitud del vástago Lunghezza dell'asta	gerade straight recta retta	aufgebogen 30° curved up 30° curva hacia arriba 30° curva verso l'alto 30°	abwärts gebogen 30° curved down 30° curva hacia abajo 30° curva verso il basso 30°
2,0 x 12,0 mm	140 mm, 5 1/2"	<b>40-054-02</b>	<b>40-055-02</b>	<b>40-061-02</b>
3,0 x 12,0 mm	140 mm, 5 1/2"	<b>40-054-03</b>	<b>40-055-03</b>	<b>40-061-03</b>
4,0 x 14,0 mm	140 mm, 5 1/2"	<b>40-054-04</b>	<b>40-055-04</b>	<b>40-061-04</b>
5,0 x 14,0 mm	140 mm, 5 1/2"	<b>40-054-05</b>	<b>40-055-05</b>	<b>40-061-05</b>
6,0 x 16,0 mm	140 mm, 5 1/2"	<b>40-054-06</b>		
2,0 x 12,0 mm	160 mm, 6 1/4"	<b>40-056-02</b>	<b>40-057-02</b>	<b>40-063-02</b>
3,0 x 12,0 mm	160 mm, 6 1/4"	<b>40-056-03</b>	<b>40-057-03</b>	<b>40-063-03</b>
4,0 x 14,0 mm	160 mm, 6 1/4"	<b>40-056-04</b>	<b>40-057-04</b>	<b>40-063-04</b>
5,0 x 14,0 mm	160 mm, 6 1/4"	<b>40-056-05</b>	<b>40-057-05</b>	<b>40-063-05</b>
6,0 x 16,0 mm	160 mm, 6 1/4"	<b>40-056-06</b>		
2,0 x 12,0 mm	185 mm, 7 1/4"	<b>40-058-02</b>	<b>40-059-02</b>	<b>40-065-02</b>
3,0 x 12,0 mm	185 mm, 7 1/4"	<b>40-058-03</b>	<b>40-059-03</b>	<b>40-065-03</b>
4,0 x 14,0 mm	185 mm, 7 1/4"	<b>40-058-04</b>	<b>40-059-04</b>	<b>40-065-04</b>
5,0 x 14,0 mm	185 mm, 7 1/4"	<b>40-058-05</b>	<b>40-059-05</b>	<b>40-065-05</b>
6,0 x 16,0 mm	185 mm, 7 1/4"	<b>40-058-06</b>		



Maulteile gefenestert und gezahnt  
 Jaws fenestrated and serrated  
 Bocas fenestradas y dentadas  
 Morsi fenestrati e dentellati



## CASPAR



Bissbreite Width of bite Ancura de la boca Larghezza del morso	Schaftlänge Length of shaft Longitud del vástago Lunghezza dell'asta	L		
		gerade straight recta retta	aufgebogen 30° curved up 30° curva hacia arriba 30° curva verso l'alto 30°	abwärts gebogen 30° curved down 30° curva hacia abajo 30° curva verso il basso 30°
2,0 x 12,0 mm	140 mm, 5 1/2"	<b>40-054-02 B</b>	<b>40-055-02 B</b>	<b>40-061-02 B</b>
3,0 x 12,0 mm	140 mm, 5 1/2"	<b>40-054-03 B</b>	<b>40-055-03 B</b>	<b>40-061-03 B</b>
4,0 x 14,0 mm	140 mm, 5 1/2"	<b>40-054-04 B</b>	<b>40-055-04 B</b>	<b>40-061-04 B</b>
5,0 x 14,0 mm	140 mm, 5 1/2"	<b>40-054-05 B</b>	<b>40-055-05 B</b>	<b>40-061-05 B</b>
6,0 x 16,0 mm	140 mm, 5 1/2"	<b>40-054-06 B</b>		
2,0 x 12,0 mm	160 mm, 6 1/4"	<b>40-056-02 B</b>	<b>40-057-02 B</b>	<b>40-063-02 B</b>
3,0 x 12,0 mm	160 mm, 6 1/4"	<b>40-056-03 B</b>	<b>40-057-03 B</b>	<b>40-063-03 B</b>
4,0 x 14,0 mm	160 mm, 6 1/4"	<b>40-056-04 B</b>	<b>40-057-04 B</b>	<b>40-063-04 B</b>
5,0 x 14,0 mm	160 mm, 6 1/4"	<b>40-056-05 B</b>	<b>40-057-05 B</b>	<b>40-063-05 B</b>
6,0 x 16,0 mm	160 mm, 6 1/4"	<b>40-056-06 B</b>		
2,0 x 12,0 mm	185 mm, 7 1/4"	<b>40-058-02 B</b>	<b>40-059-02 B</b>	<b>40-065-02 B</b>
3,0 x 12,0 mm	185 mm, 7 1/4"	<b>40-058-03 B</b>	<b>40-059-03 B</b>	<b>40-065-03 B</b>
4,0 x 14,0 mm	185 mm, 7 1/4"	<b>40-058-04 B</b>	<b>40-059-04 B</b>	<b>40-065-04 B</b>
5,0 x 14,0 mm	185 mm, 7 1/4"	<b>40-058-05 B</b>	<b>40-059-05 B</b>	<b>40-065-05 B</b>
6,0 x 16,0 mm	185 mm, 7 1/4"	<b>40-058-06 B</b>		



Maulteile gefenstert und gezahnt  
 Jaws fenestrated and serrated  
 Bocas fenestradas y dentadas  
 Morsi fenestrati e dentellati

**STEEL**  
STAINLESS

**CASPAR**

	<b>L</b>		
Bissbreite Width of bite Ancura de la boca Larghezza del morso	Schaftlänge Length of shaft Longitud del vástago Lunghezza dell'asta	gerade straight recta retta	aufgebogen 30° curved up 30° curva hacia arriba 30° curva verso l'alto 30°
2,0 mm	180 mm, 7"	<b>40-058-02 Z</b>	<b>40-059-02 Z</b>
3,0 mm	180 mm, 7"	<b>40-058-03 Z</b>	<b>40-059-03 Z</b>
4,0 mm	180 mm, 7"	<b>40-058-04 Z</b>	<b>40-059-04 Z</b>
5,0 mm	180 mm, 7"	<b>40-058-05 Z</b>	<b>40-059-05 Z</b>
6,0 mm	180 mm, 7"	<b>40-058-06 Z</b>	<b>40-059-06 Z</b>
2,0 mm	200 mm, 8"	<b>40-058-12 Z</b>	<b>40-059-12 Z</b>
3,0 mm	200 mm, 8"	<b>40-058-13 Z</b>	<b>40-059-13 Z</b>
4,0 mm	200 mm, 8"	<b>40-058-14 Z</b>	<b>40-059-14 Z</b>
5,0 mm	200 mm, 8"	<b>40-058-15 Z</b>	<b>40-059-15 Z</b>
6,0 mm	200 mm, 8"	<b>40-058-16 Z</b>	<b>40-059-16 Z</b>
2,0 mm	230 mm, 9"	<b>40-058-22 Z</b>	<b>40-059-22 Z</b>
3,0 mm	230 mm, 9"	<b>40-058-23 Z</b>	<b>40-059-23 Z</b>
4,0 mm	230 mm, 9"	<b>40-058-24 Z</b>	<b>40-059-24 Z</b>
5,0 mm	230 mm, 9"	<b>40-058-25 Z</b>	<b>40-059-25 Z</b>
6,0 mm	230 mm, 9"	<b>40-058-26 Z</b>	<b>40-059-26 Z</b>

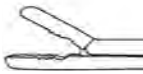
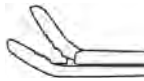
Laminektomie-Zangen, zerlegbar  
 Laminectomy rongeurs, detachable  
 Pinzas cortantes para laminectomía, desmontable  
 Pinze per laminectomia, smontabile

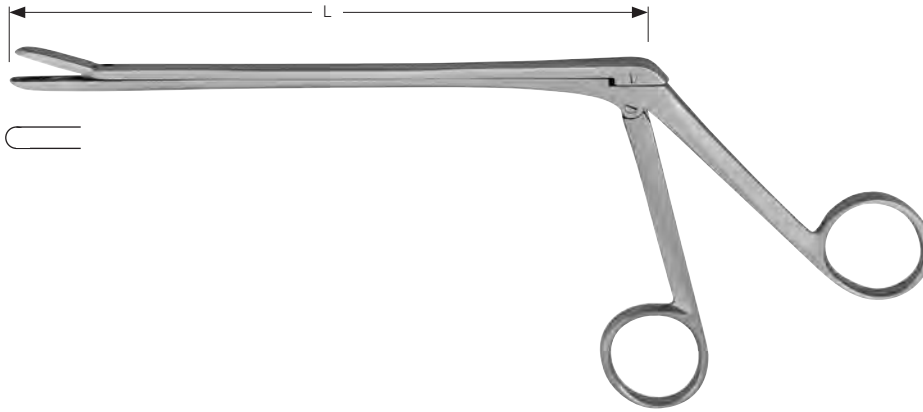


Maulteile gefenestert und gezahnt  
 Jaws fenestrated and serrated  
 Bocas fenestradas y dentadas  
 Morsi fenestrati e dentellati





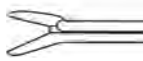
## CASPAR

	L		
Bissbreite Width of bite Ancura de la boca Larghezza del morso	Schaftlänge Length of shaft Longitud del vástago Lunghezza dell'asta	gerade straight recta retta	aufgebogen 30° curved up 30° curva hacia arriba 30° curva verso l'alto 30°
2,0 mm	180 mm, 7 "	<b>40-058-02 ZB</b>	<b>40-059-02 ZB</b>
3,0 mm	180 mm, 7 "	<b>40-058-03 ZB</b>	<b>40-059-03 ZB</b>
4,0 mm	180 mm, 7 "	<b>40-058-04 ZB</b>	<b>40-059-04 ZB</b>
5,0 mm	180 mm, 7 "	<b>40-058-05 ZB</b>	<b>40-059-05 ZB</b>
6,0 mm	180 mm, 7 "	<b>40-058-06 ZB</b>	<b>40-059-06 ZB</b>
2,0 mm	200 mm, 8 "	<b>40-058-12 ZB</b>	<b>40-059-12 ZB</b>
3,0 mm	200 mm, 8 "	<b>40-058-13 ZB</b>	<b>40-059-13 ZB</b>
4,0 mm	200 mm, 8 "	<b>40-058-14 ZB</b>	<b>40-059-14 ZB</b>
5,0 mm	200 mm, 8 "	<b>40-058-15 ZB</b>	<b>40-059-15 ZB</b>
6,0 mm	200 mm, 8 "	<b>40-058-16 ZB</b>	<b>40-059-16 ZB</b>
2,0 mm	230 mm, 9 "	<b>40-058-22 ZB</b>	<b>40-059-22 ZB</b>
3,0 mm	230 mm, 9 "	<b>40-058-23 ZB</b>	<b>40-059-23 ZB</b>
4,0 mm	230 mm, 9 "	<b>40-058-24 ZB</b>	<b>40-059-24 ZB</b>
5,0 mm	230 mm, 9 "	<b>40-058-25 ZB</b>	<b>40-059-25 ZB</b>
6,0 mm	230 mm, 9 "	<b>40-058-26 ZB</b>	<b>40-059-26 ZB</b>



STEEL  
STAINLESS

**CASPAR**

	L			
Bissbreite Width of bite Ancura de la boca Larghezza del morso	Schaftlänge Length of shaft Longitud del vástago Lunghezza dell'asta	gerade straight recta retta	aufgebogen 30° curved up 30° curva hacia arriba 30° curva verso l'alto 30°	abwärts gebogen 30° curved down 30° curva hacia abajo 30° curva verso il basso 30°
2,0 x 12,0 mm	155 mm, 6 1/8"	<b>40-070-02</b>	<b>40-070-12</b>	<b>40-070-22</b>
3,0 x 13,0 mm	155 mm, 6 1/8"	<b>40-070-03</b>	<b>40-070-13</b>	<b>40-070-23</b>
4,0 x 14,0 mm	155 mm, 6 1/8"	<b>40-070-04</b>	<b>40-070-14</b>	<b>40-070-24</b>
5,0 x 14,0 mm	155 mm, 6 1/8"	<b>40-070-05</b>	<b>40-070-15</b>	<b>40-070-25</b>



**40-072-03** 3,0 mm

gerade  
straight  
recta  
retta

**PENNYBACKER**

**40-072-03** 12,0 cm, 4 3/4"



STEEL  
STAINLESS



**40-072-07** Ø 7,0 mm

gerade  
straight  
recta  
retta

### OLDBERG

**40-072-07** 18,0 cm, 7 "

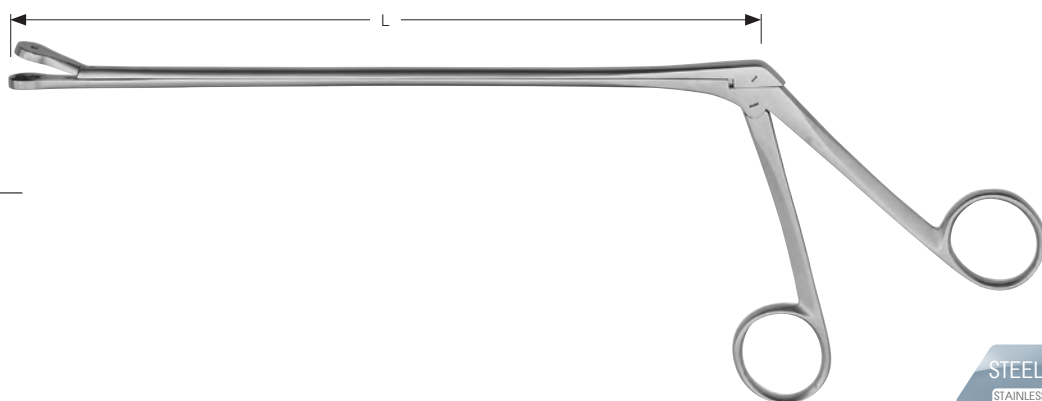


**40-074-09** Ø 9,0 mm

gerade  
straight  
recta  
retta

### LANDOLT

**40-074-09** 20,0 cm, 8 "



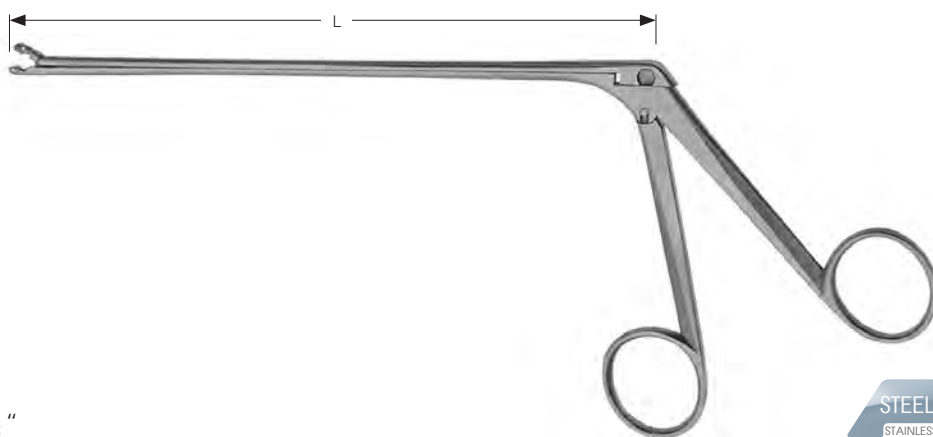
**40-076-22** Ø 2,2 mm

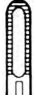
**40-076-35** Ø 3,5 mm

gerade  
straight  
recta  
retta

### YASARGIL

**40-076-22 - 40-076-35** 19,0 cm, 7 ½ "



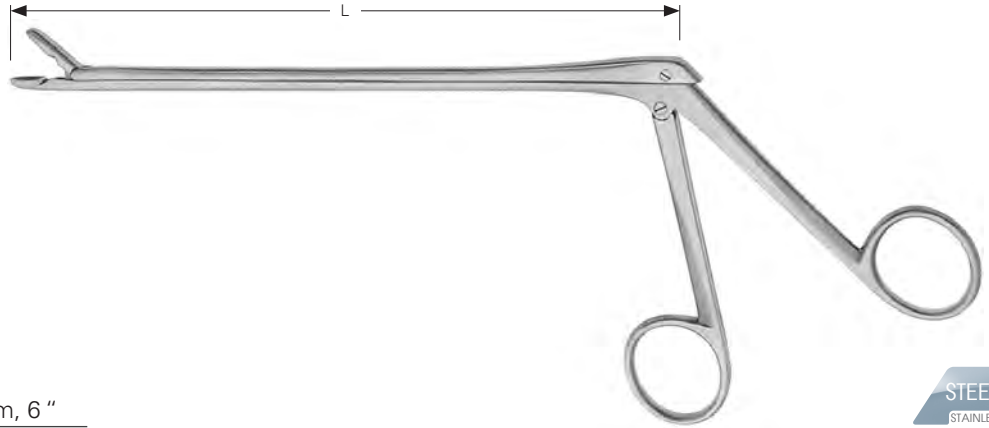


<b>40-078-02</b>	2,0 x 10,0 mm
<b>40-078-03</b>	3,0 x 10,0 mm
<b>40-078-04</b>	4,0 x 10,0 mm

gerade  
straight  
recta  
retta

**SCHLESINGER**

**40-078-02 - 40-078-04** 15,0 cm, 6 "



STEEL  
STAINLESS



6,0 x 10 mm

**40-078-16**

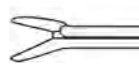
gerade  
straight  
recta  
retta



6,0 x 10 mm

**40-078-26**

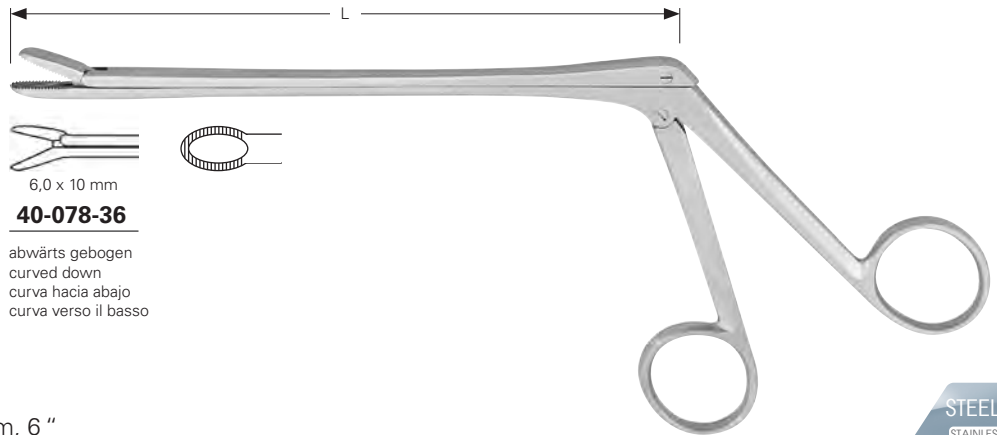
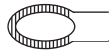
aufgebogen  
curved up  
curva hacia arriba  
curva verso l'alto



6,0 x 10 mm

**40-078-36**

abwärts gebogen  
curved down  
curva hacia abajo  
curva verso il basso



STEEL  
STAINLESS

**CLOWARD**

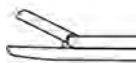
**40-078-16 - 40-078-36** 15,0 cm, 6 "



2,0 x 6,0 mm

**40-080-15**

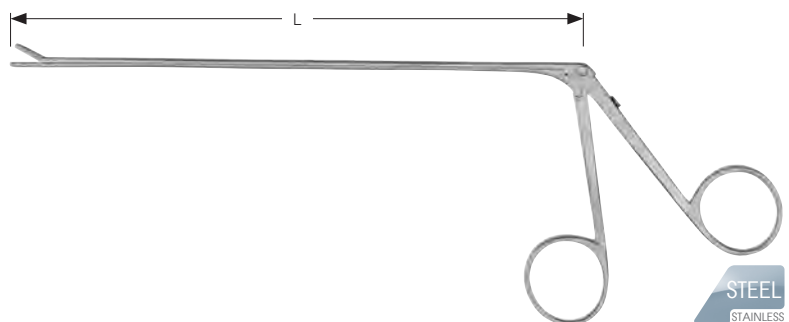
gerade  
straight  
recta  
retta



2,0 x 6,0 mm

**40-081-15**

nach links gebogen  
curved to left  
curvado al lado izquierdo  
curvo alla parte di sinistra

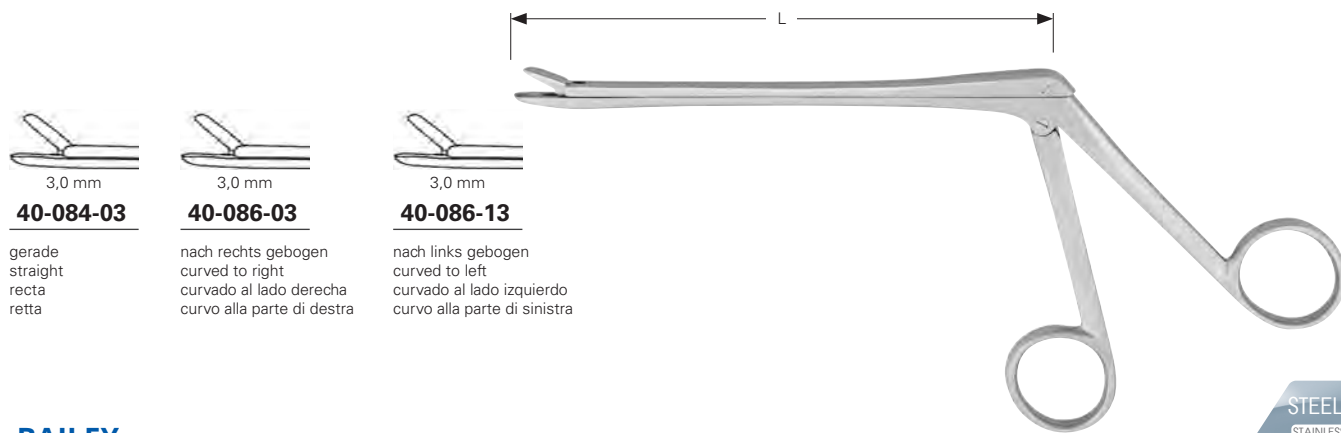


STEEL  
STAINLESS

**DECKER**

**40-080-15 - 40-081-15** 15,0 cm, 6 "





3,0 mm  
**40-084-03**

gerade  
 straight  
 recta  
 retta

3,0 mm  
**40-086-03**

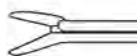
nach rechts gebogen  
 curved to right  
 curvado al lado derecha  
 curvo alla parte di destra

3,0 mm  
**40-086-13**

nach links gebogen  
 curved to left  
 curvado al lado izquierdo  
 curvo alla parte di sinistra

### BAILEY

**40-084-03 - 40-086-13** 11,5 cm, 4 ½ "

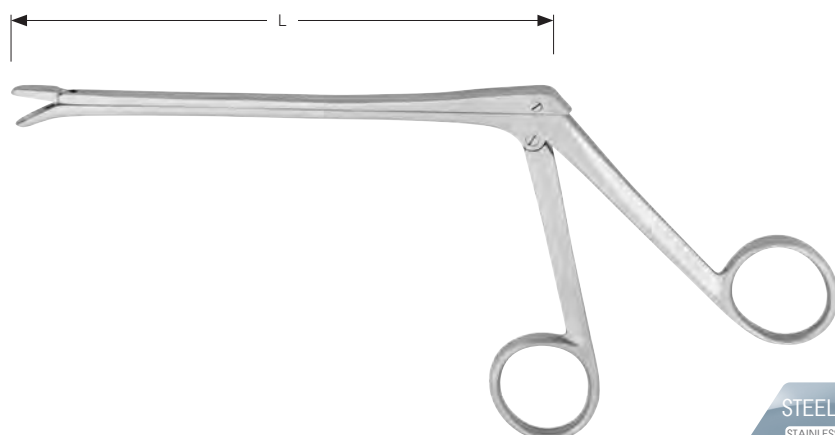


**40-085-03** 3,0 mm | 25°

**40-085-13** 3,0 mm | 70°

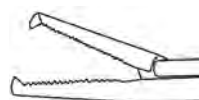
**40-085-23** 3,0 mm | 90°

abwärts gebogen  
 curved down  
 curva hacia abajo  
 curva verso il basso



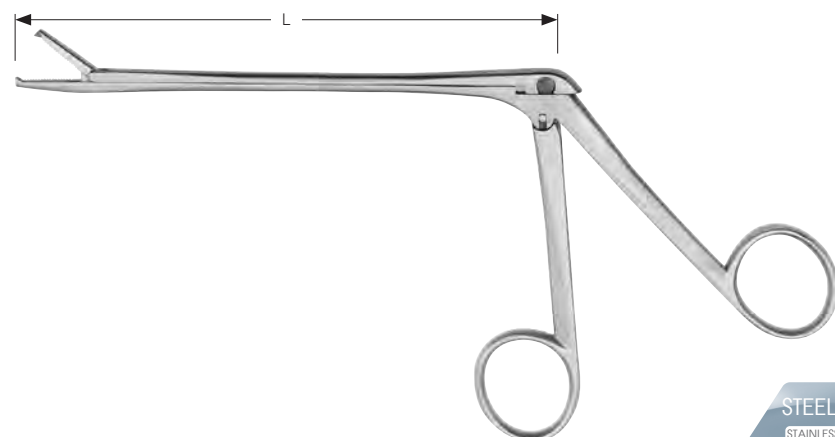
### BAILEY

**40-085-03 - 40-085-23** 11,5 cm, 4 ½ "



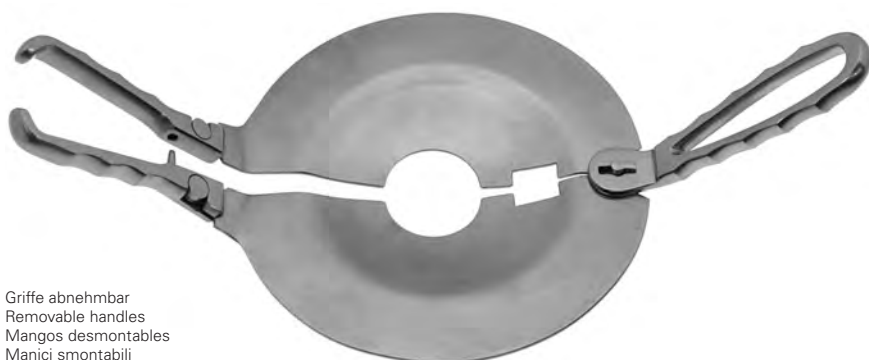
**40-090-14**

gerade  
 straight  
 recta  
 retta



### HOEN

**40-090-14** 14,0 cm, 5 ½ "



Griffe abnehmbar  
Removable handles  
Mangos desmontables  
Manici smontabili

## PERCY

40-117-01

---



Griffe umlegbar  
Reversible handles  
Mangos reversibles  
Manici reversibili

## PERCY

40-117-02

---



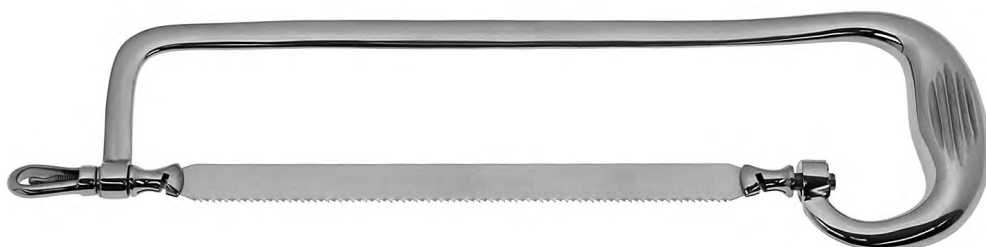
### CHARRIÈRE

**40-120-00** 35,0 cm, 13<sup>3</sup>/<sub>4</sub> "

mit 2 austauschbaren Sägeblättern 12 mm und 18 mm  
 with 2 interchangeable saw blades 12 mm and 18 mm  
 con 2 hojas de sierras intercambiables 12 mm y 18 mm  
 con 2 lame intercambiabili 12 mm e 18 mm

<b>40-120-12</b>	12,0 x 215 mm
<b>40-120-15</b>	15,0 x 215 mm
<b>40-120-20</b>	18,0 x 215 mm

Ersatzsägeblatt  
 Spare saw blade  
 Hoja de repuesto  
 Lama di ricambio



### RUST

**40-121-00** 39,0 cm, 15<sup>1</sup>/<sub>2</sub> "

mit 4 austauschbaren Sägeblättern 6 mm, 8 mm, 15 mm und 18 mm  
 with 4 interchangeable saw blades 6 mm, 8 mm, 15 mm and 18 mm  
 con 4 hojas de sierras intercambiables 6 mm, 8 mm, 15 mm y 18 mm  
 con 4 lame intercambiabili 6 mm, 8 mm, 15 mm e 18 mm

<b>40-121-06</b>	6,0 x 235 mm
<b>40-121-08</b>	8,0 x 235 mm
<b>40-121-15</b>	15,0 x 235 mm
<b>40-121-20</b>	18,0 x 235 mm

Ersatzsägeblatt  
 Spare saw blade  
 Hoja de repuesto  
 Lama di ricambio



### HELFERICH-BIER

**40-122-00** 40,5 cm, 16 "

mit 3 austauschbaren Sägeblättern 4 mm, 6 mm und 8 mm  
 with 3 interchangeable saw blades 4 mm, 6 mm and 8 mm  
 con 3 hojas de sierras intercambiables 4 mm, 6 mm y 8 mm  
 con 3 lame intercambiabili 4 mm, 6 mm e 8 mm

<b>40-122-04</b>	4,0 x 270 mm
<b>40-122-06</b>	6,0 x 270 mm
<b>40-122-08</b>	8,0 x 270 mm

Ersatzsägeblatt  
 Spare saw blade  
 Hoja de repuesto  
 Lama di ricambio



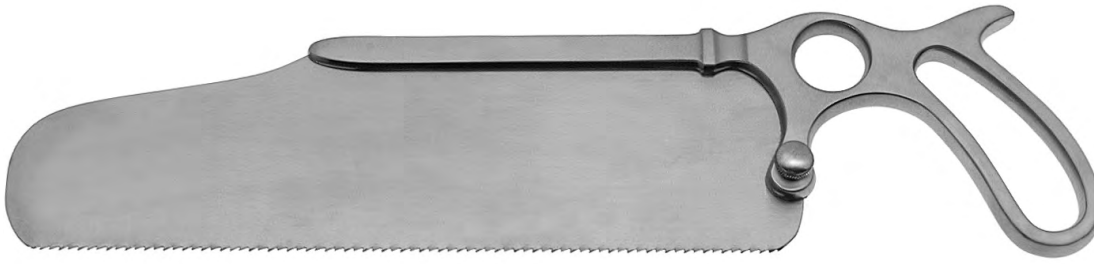
### CHARRIÈRE

**40-124-00** 27,0 cm, 10<sup>3</sup>/<sub>4</sub> "

mit 1 austauschbarem Sägeblatt  
 with 1 interchangeable saw blade  
 con 1 hojas de sierras intercambiables  
 con 1 lame intercambiabili

<b>40-124-99</b>	180 mm
------------------	--------

Ersatzsägeblatt  
 Spare saw blade  
 Hoja de repuesto  
 Lama di ricambio



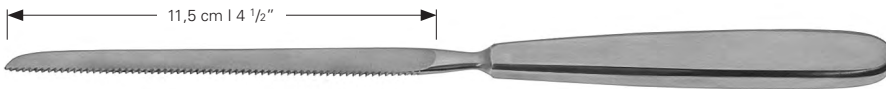
**SATTERLEE**

**40-126-00** 29,0 cm, 11 1/2"

mit 1 austauschbarem Sägeblatt  
 with 1 interchangeable saw blade  
 con 1 hojas de sierras intercambiables  
 con 1 lame intercambiabili

**40-126-99** 200 mm

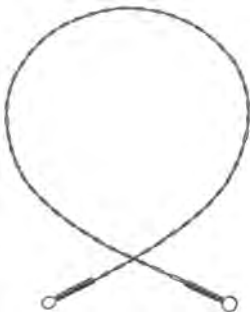
Ersatzsägeblatt  
 Spare saw blade  
 Hoja de repuesto  
 Lama di ricambio



**LANGENBECK**

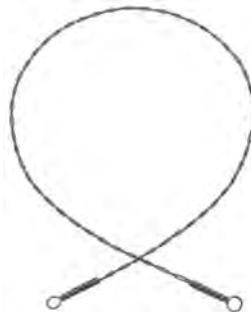
**40-128-00** 23,5 cm, 9 1/4"

fein  
 fine  
 fina  
 delicata



**OLIVECRONA**

**40-130-30** 30,0 cm, 12 "  
**40-130-40** 40,0 cm, 16 "  
**40-130-50** 50,0 cm, 20 "  
**40-130-60** 60,0 cm, 24 "  
**40-130-70** 70,0 cm, 28 "



**GIGLI**

**40-132-30** 30,0 cm, 12 "  
**40-132-40** 40,0 cm, 16 "  
**40-132-50** 50,0 cm, 20 "  
**40-132-60** 60,0 cm, 24 "  
**40-132-70** 70,0 cm, 28 "

Handgriff für Drahtsägen  
 T-Bar handle for wire saws  
 Mango con gancho, para sierras de hilo  
 Manico ad uncino per fili per sega



**GIGLI**

**40-135-00** 7,0 cm, 2 1/4"



**40-137-01**

Ersatzsägeblatt  
Spare saw blade  
Hoja de repuesto  
Lama di ricambio

**MARTIN**

**40-137-00** 17,0 cm, 6 3/4 "



**40-138-01**

Ersatzsägeblatt  
Spare saw blade  
Hoja de repuesto  
Lama di ricambio

**WALTON**

**40-138-00** 16,0 cm, 6 1/4 "



**40-139-01**

Ersatzsägeblatt  
Spare saw blade  
Hoja de repuesto  
Lama di ricambio

**40-139-00** 17,0 cm, 6 3/4 "



**40-140-01**

Ersatzsägeblatt  
Spare saw blade  
Hoja de repuesto  
Lama di ricambio

**40-140-00** 17,0 cm, 6 3/4 "



**40-150-14** 14,0 cm, 5 1/2"  
**40-150-16** 16,0 cm, 6 1/4"



**40-151-15**

**ADSON**  
**40-151-15** 15,0 cm, 6"



**ADSON**  
**40-152-14** 14,0 cm, 5 1/2"



**PERTHES**  
**40-154-18** 18,0 cm, 7"



**PERTHES**  
**40-156-21** 21,0 cm, 8 1/4"



Ø 10,0 mm  
**40-158-18**

**ZANDER**  
**40-158-18** 24,5 cm, 9 2/3"



**40-158-30** 30,0 cm, 13 1/8"





HW 320 g  
TW 420 g

Ø 26,0 mm

**40-200-22**

Ersatzbacken  
Spare discs  
Tapas de repuesto  
Piastrre di ricambio

**MEAD**

**40-200-20** 19,0 cm, 7 1/2"



HW 140 g  
TW 240 g

Ø 25,0 mm

**40-201-99**

Ersatzbacken  
Spare discs  
Tapas de repuesto  
Piastrre di ricambio



**MEAD**

**40-201-25** 18,5 cm, 7 1/4"



HW 240 g  
TW 340 g

Ø 30,0 mm

**40-202-30**

1 Seite flach  
1 Seite convex  
1 side flat  
1 side convex  
1 lato piano  
1 lato convexo  
1 lato piatto  
1 lato convesso

**COTTLE**

**40-202-30** 19,0 cm, 7 1/2"



HW 100 g  
TW 140 g

Ø 20,0 mm

**40-203-22**

mit Bleifüllung  
lead filled head  
cabezal relleno de plomo  
testa di piombo

**40-203-22** 16,5 cm, 6 1/2"



HW 160 g  
TW 220 g

Ø 22,0 mm

**40-204-22**

mit Bleifüllung  
lead filled head  
cabezal relleno de plomo  
testa di piombo

**40-204-22** 19,0 cm, 7 1/2"



HW 160 g  
TW 220 g

Ø 27,0 mm

**40-205-27**

**HAJEK**

**40-205-27** 20,0 cm, 8"



HW 180 g  
TW 240 g  
Ø 25,0 mm

**40-206-26**

Ersatzbacken  
Spare discs  
Tapas de repuesto  
Piastrre di ricambio



**40-206-25** 19,0 cm, 7 1/2 "



HW 230 g  
TW 360 g  
Ø 30,0 mm

**40-206-32**

Ersatzbacken  
Spare discs  
Tapas de repuesto  
Piastrre di ricambio



**40-206-30** 25,0 cm, 10 "



HW 230 g  
TW 360 g  
Ø 30,0 mm

**40-206-32**

Ersatzbacken  
Spare discs  
Tapas de repuesto  
Piastrre di ricambio



**40-206-30 P** 25,0 cm, 10 "



HW 290 g  
TW 480 g  
Ø 35,0 mm

**40-208-37**

Ersatzbacken  
Spare discs  
Tapas de repuesto  
Piastrre di ricambio



komplett  
complete  
completo  
completo

**WAGNER**

**40-208-35** 24,5 cm, 9 3/4 "



HW 470 g  
TW 660 g  
Ø 35,0 mm

**40-208-36**

Ersatzbacken  
Spare discs  
Tapas de repuesto  
Piastrre di ricambio



Ersatz-Schlüssel  
Spare wrench  
Llave de repuesto  
Chiave di ricambio

**WAGNER**

**40-208-38**



HW 100 g  
TW 200 g  
Ø 35,0 mm

**40-210-35**

HW 170 g  
TW 260 g  
Ø 42,0 mm

**40-210-42**

HW 220 g  
TW 320 g  
Ø 50,0 mm

**40-210-50**



**40-210-35 - 40-210-50** 26,0 cm, 10 1/4 "





HW 300 g  
TW 480 g  
Ø 30,0 mm

**40-211-30**

**BERGMANN**

**40-211-30** 23,5 cm, 9 ¼ "



HW 380 g  
TW 560 g  
Ø 45,0 mm

**40-211-45**

**BERGMANN**

**40-211-45** 25,0 cm, 10 "



HW 420 g  
TW 600 g  
Ø 29 | 42 mm

**40-212-42**

**40-212-42** 25,0 cm, 10 "



HW 560 g  
TW 740 g  
Ø 40,0 mm

**40-213-40**

**OMBREDANNE**

**40-213-40** 25,0 cm, 10 "



HW 700 g  
TW 860 g  
Ø 40,0 mm

**40-214-40**

**HEATH**

**40-214-40** 18,5 cm, 7 ¼ "



HW 1000 g  
TW 1160 g  
Ø 45,0 mm

**40-214-45**

**HEATH**

**40-214-45** 20,0 cm, 8 "



HW 160 g  
TW 320 g

Ø 26,0 mm

**40-215-26**

mit Bleifüllung  
lead filled head  
cabezal relleno de plomo  
testa di piombo

HW 240 g  
TW 380 g

Ø 30,0 mm

**40-215-30**

mit Bleifüllung  
lead filled head  
cabezal relleno de plomo  
testa di piombo

**WILLIGER**

**40-215-26 - 40-215-30** 24,0 cm, 9 ½"



HW 100 g  
TW 120 g

Ø 25,0 mm

**40-216-25**

HW 140 g  
TW 180 g

Ø 30,0 mm

**40-216-30**

HW 220 g  
TW 240 g

Ø 35,0 mm

**40-216-35**

**DOYEN**

**40-216-25 - 40-216-35** 19,5 cm, 7 ¾"



HW 220 g  
TW 240 g

Ø 30,0 mm

**40-217-30**

**COLLIN**

**40-217-30** 20,0 cm, 8"



HW 120 g  
TW 200 g

Ø 19,0 mm

**40-218-19**

HW 140 g  
TW 240 g

Ø 25,0 mm

**40-218-25**

HW 160 g  
TW 260 g

Ø 30,0 mm

**40-218-30**

**LUCAE**

**40-218-19 - 40-218-30** 19,5 cm, 7 ¾"



HW 100 g  
TW 140 g  
Ø 20,0 mm

**40-219-20**

mit Bleifüllung  
lead filled head  
cabezal relleno de plomo  
testa di piombo

HW 75 g  
TW 130 g  
Ø 20,0 mm

**40-219-21**

mit Messingfüllung  
brass filled head  
cabezal relleno de latón  
testa di ottone

**40-219-20 - 40-219-21** 16,5 cm, 6 ½ "



HW 260 g  
TW 360 g  
Ø 25,0 mm

**40-220-01**

mit Bleifüllung  
lead filled head  
cabezal relleno de plomo  
testa di piombo

**GERZOG**

**40-220-01** 19,0 cm, 7 ½ "



HW 680 g  
TW 780 g  
Ø 40,0 mm

**40-220-02**

**KIRK**

**40-220-02** 21,0 cm, 8 ¼ "



HW 160 g  
TW 200 g  
Ø 22,0 mm

**40-222-22**

mit Bleifüllung  
lead filled head  
cabezal relleno de plomo  
testa di piombo

HW 120 g  
TW 160 g  
Ø 22,0 mm

**40-222-23**

**PARTSCH**

**40-222-22 - 40-222-23** 19,0 cm, 7 ½ "



HW 300 g  
TW 500 g  
Ø 30,0 mm

**40-221-30**



**40-221-30** 26,5 cm, 10 ½ "



HW 300 g  
TW 500 g  
Ø 30,0 mm

**40-221-30 P**



**40-221-30 P** 26,5 cm, 10 ½ "



HW 300 g  
TW 360 g  
Ø 80 x 60 mm  
**40-223-60**



**STEINBACH**

**40-223-60** 24,0 cm, 9 ½"



HW 250 g  
TW 350 g  
Ø 42,0 mm  
**40-224-42**

mit Bleifüllung  
lead filled head  
cabezal relleno de plomo  
testa di piombo



**40-224-42** 26,0 cm, 10 ¼"



HW 170 g  
TW 260 g  
Ø 42,0 mm  
**40-225-42**



**40-225-42** 26,0 cm, 10 ¼"



HW 240 g  
TW 340 g  
Ø 42,0 mm  
**40-226-42**

mit Bleifüllung  
lead filled head  
cabezal relleno de plomo  
testa di piombo



**40-226-42** 26,0 cm, 10 ¼"



HW 45 g  
TW 125 g  
Ø 33,0 mm  
**40-227-30**



**40-227-30** 22,0 cm, 8 ¾"



HW 440 g  
TW 640 g  
Ø 30 | 42 mm  
**40-228-42**



**40-228-42** 26,0 cm, 10 ¼"



HW 440 g  
TW 640 g  
Ø 30 | 42 mm  
**40-228-42 P**



HW 500 g  
TW 700 g  
Ø 30,0 mm  
**40-229-99**

Ersatzbacken  
Spare discs  
Tapas de repuesto  
Piastrre di ricambio



HW 500 g  
TW 700 g  
Ø 30,0 mm  
**40-229-99**

Ersatzbacken  
Spare discs  
Tapas de repuesto  
Piastrre di ricambio



**40-228-42 P** 26,0 cm, 10 ¼"

**40-229-29** 26,5 cm, 10 ½"

**40-229-29 P** 26,5 cm, 10 ½"



HW 450 g  
TW 640 g  
Ø 30,0 mm  
**40-230-45**



HW 900 g  
TW 1100 g  
Ø 50,0 mm  
**40-230-90**



HW 450 g  
TW 640 g  
Ø 30,0 mm  
**40-230-45 P**



HW 900 g  
TW 1100 g  
Ø 50,0 mm  
**40-230-90 P**

**40-230-45 - 40-230-90** 26,5 cm, 10 ¼"

**40-230-45 P - 40-230-90 P** 26,5 cm, 10 ¼"

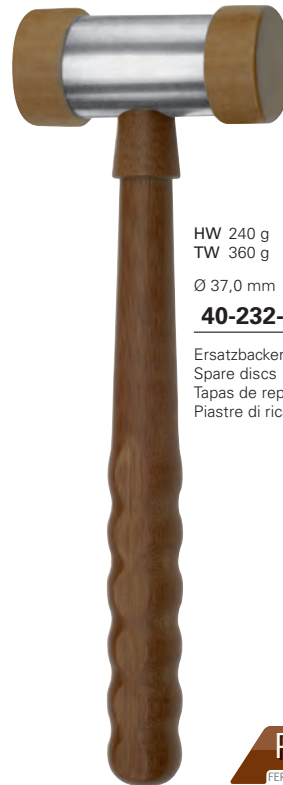


HW 380 g  
TW 460 g  
Ø 30,0 mm

**40-231-48**



**40-231-48** 24,0 cm, 9 1/2"



HW 240 g  
TW 360 g  
Ø 37,0 mm

**40-232-42**

Ersatzbacken  
Spare discs  
Tapas de repuesto  
Piastrre di ricambio



**40-232-37** 24,0 cm, 9 1/2"



HW 180 g  
TW 300 g  
Ø 30,0 mm

**40-234-35**

HW 350 g  
TW 500 g  
Ø 40,0 mm

**40-234-70**



**40-234-35 - 40-234-70** 24,0 cm, 9 1/2"



HW 420 g  
TW 600 g

Ø 24 | 14 mm

**40-235-00**

**40-235-00** 23,5 cm, 9 1/4"



HW 260 g  
TW 400 g

Ø 20,0 mm

**40-236-23**

**40-236-23** 23,0 cm, 9"



Autopsie-Besteck  
 Post mortem set  
 Juego de autopsia  
 Set per autopsia

**40-240-00**



**40-240-14** 14,0 cm, 5 1/2"



**VIRCHOW**

**40-240-15** 7,5 cm, 3"



**40-241-23**



Osteotom  
 Osteotome  
 Osteotómo  
 Osteotomo

**40-241-23** 13,0 cm, 5 1/8"



**40-242-22** 22,0 cm, 8 3/4"





- Robuste Konstruktion
- Hohe Belastbarkeit im Dauerbetrieb
- Vibrationsarm
- Eingebauter Überlastungsschutz
- Construcción robusta
- Alta capacidad de carga también en régimen continuo
- Amortiguación de la vibración
- Protección incorporada contra sobrecarga
- Robust construction
- Maximum capacity also in permanent service
- Low vibration
- Built-in overload protection
- Construzione robusta
- Alta capacità di carica a regime continuo
- Vibrazioni attenuate al minimo
- Protezione di sovraccarico incorporata

Standard Modell  
Standard pattern  
Modelo estándar  
Modello standard



**ELECTRO POWER**

**40-244-00** 230 V | 50 Hz  
**40-244-01** 110 V | 60 Hz

Komplett, bestehend aus:

1 Oszillierende Autopsiesäge	
1 Sägeblatt, Ø 50 mm	<b>48-110-50</b>
1 Sägeblatt, Ø 65 mm	<b>48-110-65</b>
1 Sägeblatt, Ø 65 mm	<b>48-130-65</b>
1 Gabelschlüssel, paar	<b>48-110-01</b>

Complete, consisting of:

1 Oscillating autopsy saw	
1 Saw blade, Ø 50 mm	<b>48-110-50</b>
1 Saw blade, Ø 65 mm	<b>48-110-65</b>
1 Saw blade, Ø 65 mm	<b>48-130-65</b>
1 Wrench, pair	<b>48-110-01</b>

Completo, compuesto de:

1 Sierra oscilante para autopsia	
1 Hoja de sierra, Ø 50 mm	<b>48-110-50</b>
1 Hoja de sierra, Ø 65 mm	<b>48-110-65</b>
1 Hoja de sierra, Ø 65 mm	<b>48-130-65</b>
1 Llaves de boca, par	<b>48-110-01</b>

Completo, composto da:

1 Seghe oscillante per autopsia	
1 Sega, Ø 50 mm	<b>48-110-50</b>
1 Sega, Ø 65 mm	<b>48-110-65</b>
1 Sega, Ø 65 mm	<b>48-130-65</b>
1 Chiavi fisse, paio	<b>48-110-01</b>

Aufnahme mit Dreikantschaft  
Triangular shaft adaptor for saw blades  
Vestago adaptador triangular para hojas de sierra  
Adattatore ad asta trianolare per lame da sega



**ELECTRO POWER**

**40-244-03** 230 V | 50 Hz  
**40-244-04** 110 V | 60 Hz

Komplett, bestehend aus:

1 Oszillierende Autopsiesäge	
1 Sägeblatt, Ø 50 mm	<b>48-110-50</b>
1 Sägeblatt, Ø 65 mm	<b>48-110-65</b>
1 Sägeblatt, Ø 65 mm	<b>48-130-65</b>
1 Gabelschlüssel, paar	<b>48-110-01</b>

Complete, consisting of:

1 Oscillating autopsy saw	
1 Saw blade, Ø 50 mm	<b>48-110-50</b>
1 Saw blade, Ø 65 mm	<b>48-110-65</b>
1 Saw blade, Ø 65 mm	<b>48-130-65</b>
1 Wrench, pair	<b>48-110-01</b>

Completo, compuesto de:

1 Sierra oscilante para autopsia	
1 Hoja de sierra, Ø 50 mm	<b>48-110-50</b>
1 Hoja de sierra, Ø 65 mm	<b>48-110-65</b>
1 Hoja de sierra, Ø 65 mm	<b>48-130-65</b>
1 Llaves de boca, par	<b>48-110-01</b>

Completo, composto da:

1 Seghe oscillante per autopsia	
1 Sega, Ø 50 mm	<b>48-110-50</b>
1 Sega, Ø 65 mm	<b>48-110-65</b>
1 Sega, Ø 65 mm	<b>48-130-65</b>
1 Chiavi fisse, paio	<b>48-110-01</b>

Technische Daten

Anschlußspannung 230 V~, 50 Hz / 110 V~, 60 Hz  
Leistung 500 Watt  
Schwingungen 6.500 bis 24.000 Schwingungen / Minute stufenlos regulierbar.  
Anschlußkabel 5 Meter-Kabel mit Euro-Flachstecker (230 V)  
3 Meter-Kabel mit USA-Stecker (110 V)

Datos técnicos

Tensión de alimentación 230 V~, 50 Hz / 110 V~, 60 Hz  
Potencia absorbida 500 Watt  
Oscilaciones de 6.500 a 24.000 oscilaciones por minuto regulación progresiva.  
Cable de alimentación: Cable de 5 metros con enchufe plano para Europa (230 V) Cable de 3 metros con enchufe para EE.UU. (110 V)

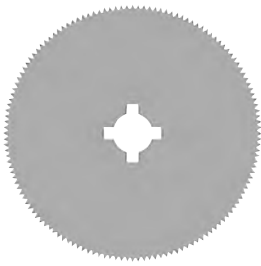
Technical data

Supply voltage 230 V~, 50 Hz / 110 V~, 60 Hz  
Power 500 Watt  
Oscillations 6.500 to 24.000 oscillations / minute steplessly adjustable  
Connection cable 5 meter cable with Euro-plug (230 V)  
3 meter cable with USA-plug (110 V)

Dati tecnici

Tensione di collagamento 230 V~, 50 Hz / 110 V~, 60 Hz  
Potenza assorbita 500 Watt  
Oscillazioni da 6.500 a 24.000 oscillazioni al minuto, con regolazione continua  
Cavo di collegamento: Cavo da 5 metri con spina piatta europea (230 V)  
Cavo di 3 metri con spina USA (110 V)



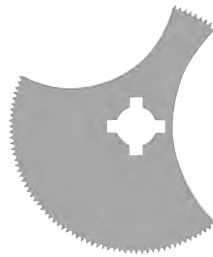


**48-110-45** Ø 45,0 mm

**48-110-50** Ø 50,0 mm

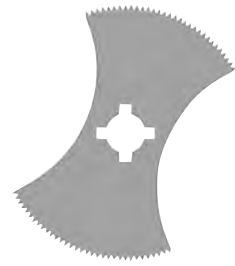
**48-110-65** Ø 65,0 mm

Sägeblatt für Naturgipsverbände  
 Saw blade for normal plaster  
 Hoja de sierra para vendaje de yeso  
 Segha per bendaggi in gesso naturale



**48-130-65** Ø 65,0 mm

Sägeblatt Autopsie für Naturgipsverbände  
 Autopsy saw blade for normal plaster  
 Hoja de sierra de autopsia para vendaje de yeso  
 Segha autopsia per bendaggi in gesso naturale



**48-150-65** Ø 65,0 mm

Sägeblatt Segment für Naturgipsverbände  
 Segmented saw blade for normal plaster  
 Hoja de sierra de segmentos para vendaje de yeso  
 Segha segmento per bendaggi in gesso naturale

**48-120-45** Ø 45,0 mm

**48-120-50** Ø 50,0 mm

**48-120-65** Ø 65,0 mm

Sägeblatt für synthetische Hartverbände  
 Saw blade for synthetic casts  
 Hoja de sierra de profundidad para vendajes sintéticos rígidos  
 Segha per bendaggi duri sintetici

**48-140-65** Ø 65,0 mm

Sägeblatt Autopsie für synthetische Hartverbände  
 Autopsy saw blade for synthetic casts  
 Hoja de sierra de autopsia para vendajes sintéticos rígidos  
 Segha autopsia per bendaggi duri sintetici

**48-160-65** Ø 65,0 mm

Sägeblatt Segment für synthetische Hartverbände  
 Segmented saw blade for synthetic casts  
 Hoja de sierra de segmentos para vendajes sintéticos rígidos  
 Segha segmento per bendaggi duri sintetici



**48-170-08** 8,0 mm

**48-170-20** 20,0 mm

Tiefensägeblatt für Naturgipsverbände  
 Deep saw blade for normal plaster  
 Hoja de sierra de profundidad para vendaje de yeso  
 Segha a taglio di profondità per bendaggi in gesso naturale



**48-190-99** Ø 65,0 mm

Exzentrische Begrenzungsscheibe für Tiefenbegrenzung  
 Excentric disc to limit depth of cut  
 Disco de tope excéntrico para tope de profundidad  
 Disco di limitazione eccentrico per limitazione della profondità



**48-110-01**

Gabelschlüssel für Sägeblattwechsel, Paar  
 Wrenches for exchange of saw blades, pair  
 Llaves de boca para cambiar la hoja de sierra, par  
 Chiavi per cambiare la lama per sega, paio

**48-180-08** 8,0 mm

**48-180-20** 20,0 mm

Tiefensägeblatt für synthetische Hartverbände  
 Deep saw blade for synthetic casts  
 Hoja de sierra de profundidad para vendaje sintéticos rígidos  
 Segha a taglio di profondità per bendaggi duri sintetici



**48-110-02**

Transportkoffer, blau, inklusive Formeinlage für BLUE oder ELEKTRO POWER  
 Transport case, blue, including inlay for BLUE or ELECTRO POWER  
 Transporte valija, azul, inclusive pieza postiza per BLUE o ELECTRO POWER  
 Cargo valigetta, blu, incluso inserto per BLUE o ELECTRO POWER



<b>40-250-25</b>	2,5 mm
<b>40-250-35</b>	3,5 mm



**PASSOW**

**40-250-25 - 40-250-35** 12,0 cm, 4 3/4"



<b>40-251-02</b>	Ø 2,0 mm
<b>40-251-03</b>	Ø 3,0 mm
<b>40-251-04</b>	Ø 4,0 mm
<b>40-251-05</b>	Ø 5,0 mm
<b>40-251-06</b>	Ø 6,0 mm
<b>40-251-08</b>	Ø 8,0 mm
<b>40-251-10</b>	Ø 10,0 mm



**40-251-02 - 40-251-10** 16,0 cm, 6 1/4"



<b>40-252-03</b>	Ø 3,0 mm
<b>40-252-05</b>	Ø 5,0 mm
<b>40-252-08</b>	Ø 8,0 mm
<b>40-252-12</b>	Ø 12,0 mm
<b>40-252-14</b>	Ø 14,0 mm
<b>40-252-16</b>	Ø 16,0 mm



**CASPAR**

**40-252-03 - 40-252-16** 20,0 cm, 8"

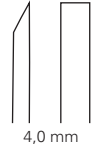


<b>40-252-03 P</b>	Ø 3,0 mm
<b>40-252-05 P</b>	Ø 5,0 mm
<b>40-252-08 P</b>	Ø 8,0 mm
<b>40-252-12 P</b>	Ø 12,0 mm
<b>40-252-14 P</b>	Ø 14,0 mm
<b>40-252-16 P</b>	Ø 16,0 mm



**40-252-03 P - 40-252-16 P** 20,0 cm, 8"



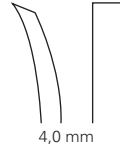


**40-254-04**

Flachmeißel  
 Chisel  
 Cincele  
 Scalpelli

**FREER**

**40-254-04** 17,0 cm, 6 3/4"

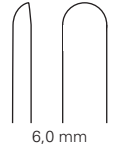


**40-255-04**

Flachmeißel  
 Chisel  
 Cincele  
 Scalpelli

**FREER**

**40-255-04** 17,0 cm, 6 3/4"

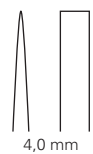


**40-256-06**

Hohlmeißel  
 Gouge  
 Gubia  
 Sgorbie

**FREER**

**40-256-06** 15,0 cm, 6"

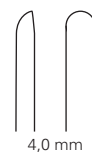


**40-258-04**

Flachmeißel  
 Chisel  
 Cincele  
 Scalpelli

**WEST**

**40-258-04** 16,0 cm, 6 1/4"

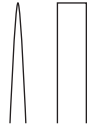
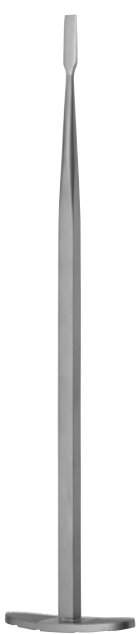


**40-259-04**

Hohlmeißel  
 Gouge  
 Gubia  
 Sgorbie

**WEST**

**40-259-04** 16,0 cm, 6 1/4"



**40-260-04** 4,0 mm

**40-260-06** 6,0 mm

**40-260-08** 8,0 mm

Osteotome  
Osteotomes  
Osteótomos  
Osteotomi

**DUNN-DAUTREY**

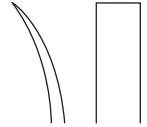
**40-260-04 - 40-260-08** 16,5 cm, 6 1/2"



6,0 mm

**40-261-01**

Osteotome  
Osteotomes  
Osteótomos  
Osteotomi



6,0 mm

**40-261-03**

Osteotome  
Osteotomes  
Osteótomos  
Osteotomi

**DUNN-DAUTREY**

**40-261-01** 17,0 cm, 6 3/4"

**DUNN-DAUTREY**

**40-261-03** 17,0 cm, 6 3/4"



**40-262-55** 5,0 mm

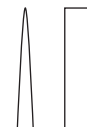
**40-262-77** 7,0 mm

**40-262-99** 9,0 mm

Osteotome  
Osteotomes  
Osteótomos  
Osteotomi

**GILLIES**

**40-262-55 - 40-262-99** 14,0 cm, 5 1/2"



**40-262-04** 4,0 mm

**40-262-06** 6,0 mm

**40-262-08** 8,0 mm

**40-262-10** 10,0 mm

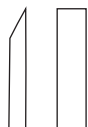
**40-262-12** 12,0 mm

**40-262-14** 14,0 mm

**40-262-16** 16,0 mm

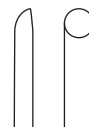
Osteotome  
Osteotomes  
Osteótomos  
Osteotomi

**40-262-04 - 40-262-16** 14,0 cm, 5 1/2"



<b>40-263-04</b>	4,0 mm
<b>40-263-06</b>	6,0 mm
<b>40-263-08</b>	8,0 mm
<b>40-263-10</b>	10,0 mm
<b>40-263-12</b>	12,0 mm
<b>40-263-14</b>	14,0 mm
<b>40-263-16</b>	16,0 mm

Flachmeißel  
 Chisels  
 Cinceles  
 Scalpelli

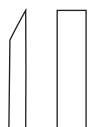


<b>40-264-04</b>	4,0 mm
<b>40-264-06</b>	6,0 mm
<b>40-264-08</b>	8,0 mm
<b>40-264-10</b>	10,0 mm
<b>40-264-12</b>	12,0 mm
<b>40-264-14</b>	14,0 mm
<b>40-264-16</b>	16,0 mm

Hohlmeißel  
 Gouges  
 Gubias  
 Sgorbie

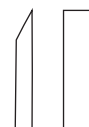
**40-263-04 - 40-263-16** 14,0 cm, 5 ½"

**40-264-04 - 40-264-16** 14,0 cm, 5 ½"



<b>40-265-02</b>	2,0 mm
<b>40-265-03</b>	3,0 mm
<b>40-265-04</b>	4,0 mm
<b>40-265-05</b>	5,0 mm
<b>40-265-06</b>	6,0 mm
<b>40-265-08</b>	8,0 mm
<b>40-265-10</b>	10,0 mm
<b>40-265-12</b>	12,0 mm

Flachmeißel  
 Chisels  
 Cinceles  
 Scalpelli



<b>40-266-02</b>	2,0 mm
<b>40-266-03</b>	3,0 mm
<b>40-266-04</b>	4,0 mm
<b>40-266-05</b>	5,0 mm
<b>40-266-06</b>	6,0 mm
<b>40-266-07</b>	7,0 mm
<b>40-266-08</b>	8,0 mm

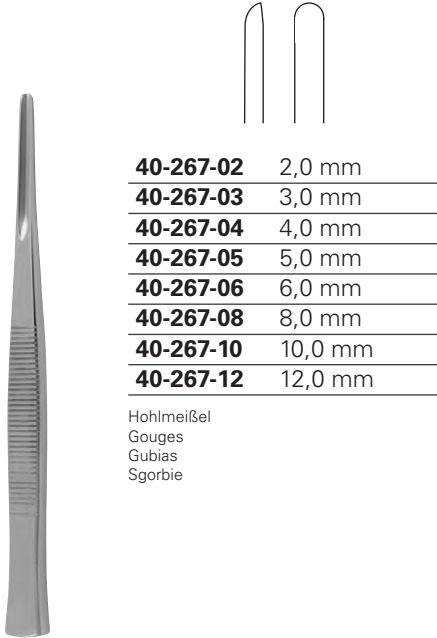
Flachmeißel  
 Chisels  
 Cinceles  
 Scalpelli

**PARTSCH**

**40-265-02 - 40-265-12** 14,0 cm, 5 ½"

**PARTSCH**

**40-266-02 - 40-266-08** 17,0 cm, 6 ¾"

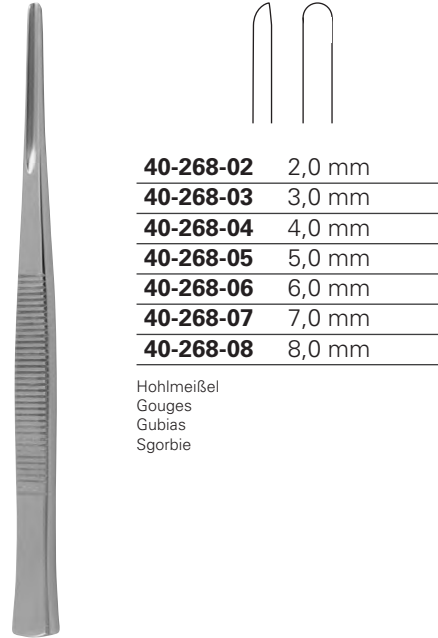


<b>40-267-02</b>	2,0 mm
<b>40-267-03</b>	3,0 mm
<b>40-267-04</b>	4,0 mm
<b>40-267-05</b>	5,0 mm
<b>40-267-06</b>	6,0 mm
<b>40-267-08</b>	8,0 mm
<b>40-267-10</b>	10,0 mm
<b>40-267-12</b>	12,0 mm

Hohlmeißel  
Gouges  
Gubias  
Sgorbie

**PARTSCH**

**40-267-02 - 40-267-12** 14,0 cm, 5 1/2"



<b>40-268-02</b>	2,0 mm
<b>40-268-03</b>	3,0 mm
<b>40-268-04</b>	4,0 mm
<b>40-268-05</b>	5,0 mm
<b>40-268-06</b>	6,0 mm
<b>40-268-07</b>	7,0 mm
<b>40-268-08</b>	8,0 mm

Hohlmeißel  
Gouges  
Gubias  
Sgorbie

**PARTSCH**

**40-268-02 - 40-268-08** 17,0 cm, 6 3/4"



3,4 mm

**40-268-34**

Meißel  
Chisels  
Cinceles  
Scalpelli

**40-268-34** 13,5 cm, 5 1/4"

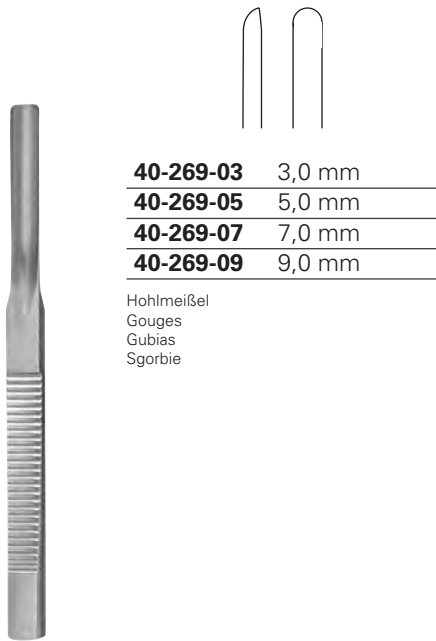


3,4 mm

**40-268-35**

Meißel  
Chisels  
Cinceles  
Scalpelli

**40-268-35** 13,5 cm, 5 1/4"

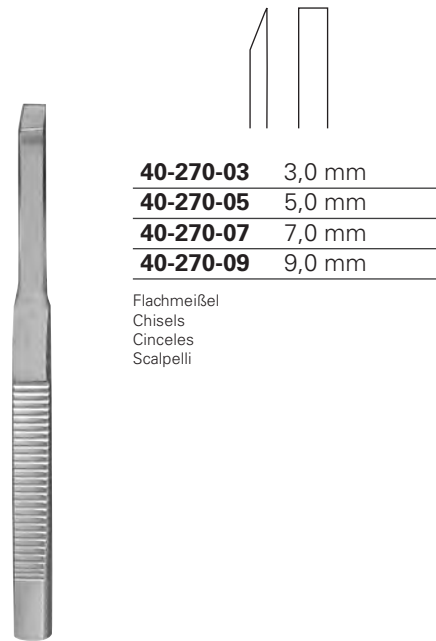


<b>40-269-03</b>	3,0 mm
<b>40-269-05</b>	5,0 mm
<b>40-269-07</b>	7,0 mm
<b>40-269-09</b>	9,0 mm

Hohlmeißel  
 Gouges  
 Gubias  
 Sgorbie

### TRAUTMANN

**40-269-03 - 40-269-09** 14,0 cm, 5 ½"

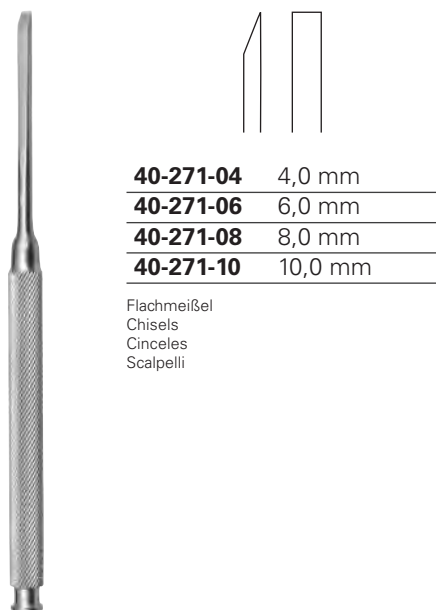


<b>40-270-03</b>	3,0 mm
<b>40-270-05</b>	5,0 mm
<b>40-270-07</b>	7,0 mm
<b>40-270-09</b>	9,0 mm

Flachmeißel  
 Chisels  
 Cinceles  
 Scalpelli

### TRAUTMANN

**40-270-03 - 40-270-09** 14,0 cm, 5 ½"

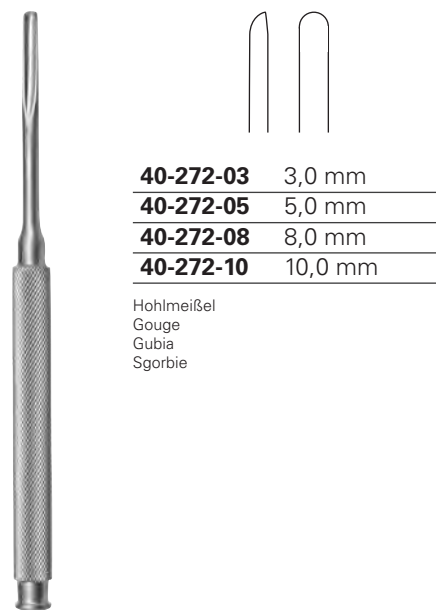


<b>40-271-04</b>	4,0 mm
<b>40-271-06</b>	6,0 mm
<b>40-271-08</b>	8,0 mm
<b>40-271-10</b>	10,0 mm

Flachmeißel  
 Chisels  
 Cinceles  
 Scalpelli

### BRUENINGS-LUCAS

**40-271-04 - 40-271-10** 16,0 cm, 6 ¼"

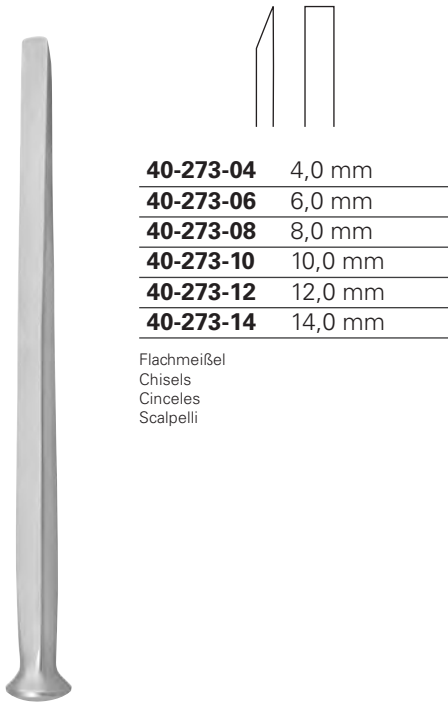


<b>40-272-03</b>	3,0 mm
<b>40-272-05</b>	5,0 mm
<b>40-272-08</b>	8,0 mm
<b>40-272-10</b>	10,0 mm

Hohlmeißel  
 Gouge  
 Gubia  
 Sgorbie

### BRUENINGS-LUCAS

**40-272-03 - 40-272-10** 16,0 cm, 6 ¼"

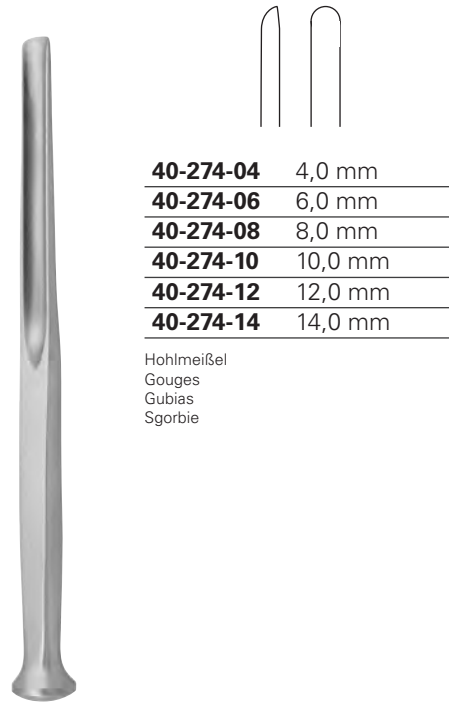


<b>40-273-04</b>	4,0 mm
<b>40-273-06</b>	6,0 mm
<b>40-273-08</b>	8,0 mm
<b>40-273-10</b>	10,0 mm
<b>40-273-12</b>	12,0 mm
<b>40-273-14</b>	14,0 mm

Flachmeißel  
 Chisels  
 Cinceles  
 Scalpelli

**ALEXANDER**

**40-273-04 - 40-273-14** 17,5 cm, 7 "

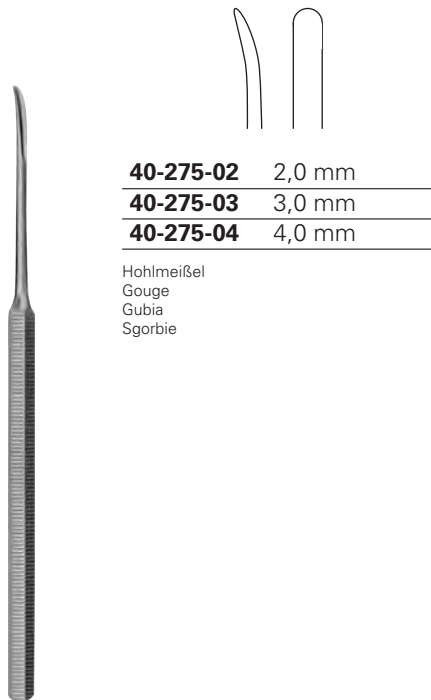


<b>40-274-04</b>	4,0 mm
<b>40-274-06</b>	6,0 mm
<b>40-274-08</b>	8,0 mm
<b>40-274-10</b>	10,0 mm
<b>40-274-12</b>	12,0 mm
<b>40-274-14</b>	14,0 mm

Hohlmeißel  
 Gouges  
 Gubias  
 Sgorbie

**ALEXANDER**

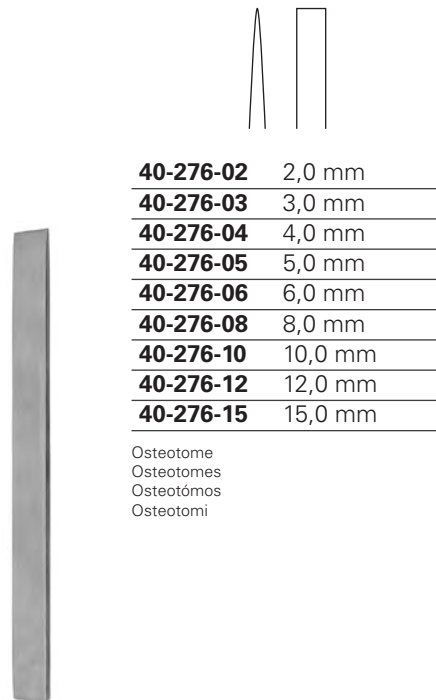
**40-274-04 - 40-274-14** 17,5 cm, 7 "



<b>40-275-02</b>	2,0 mm
<b>40-275-03</b>	3,0 mm
<b>40-275-04</b>	4,0 mm

Hohlmeißel  
 Gouge  
 Gubia  
 Sgorbie

**40-275-02 - 40-275-04** 16,0 cm, 6 ¼ "



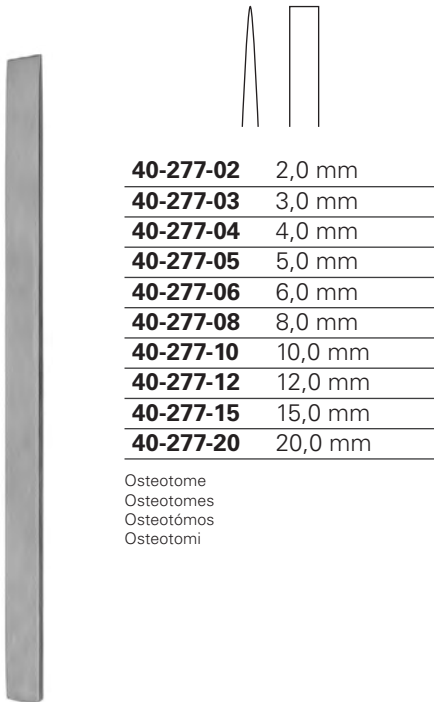
<b>40-276-02</b>	2,0 mm
<b>40-276-03</b>	3,0 mm
<b>40-276-04</b>	4,0 mm
<b>40-276-05</b>	5,0 mm
<b>40-276-06</b>	6,0 mm
<b>40-276-08</b>	8,0 mm
<b>40-276-10</b>	10,0 mm
<b>40-276-12</b>	12,0 mm
<b>40-276-15</b>	15,0 mm

Osteotome  
 Osteotomes  
 Osteótomos  
 Osteotomi

**MINI-LAMBOTTE**

**40-276-02 - 40-276-15** 12,5 cm, 5 "



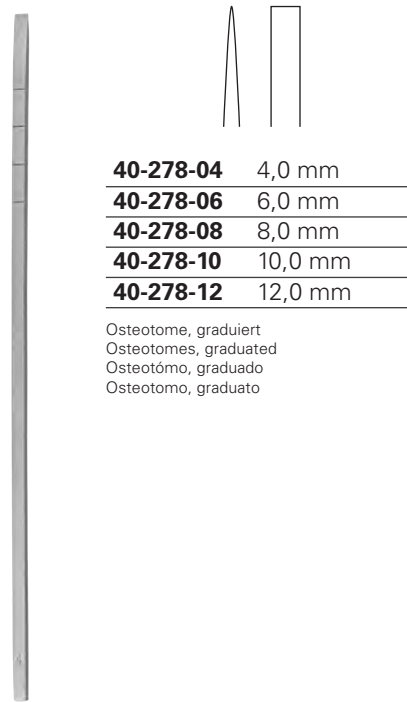


<b>40-277-02</b>	2,0 mm
<b>40-277-03</b>	3,0 mm
<b>40-277-04</b>	4,0 mm
<b>40-277-05</b>	5,0 mm
<b>40-277-06</b>	6,0 mm
<b>40-277-08</b>	8,0 mm
<b>40-277-10</b>	10,0 mm
<b>40-277-12</b>	12,0 mm
<b>40-277-15</b>	15,0 mm
<b>40-277-20</b>	20,0 mm

Osteotome  
 Osteotomes  
 Osteótomos  
 Osteotomi

### MINI-LAMBOTTE

**40-277-02 - 40-276-20** 17,0 cm, 6 ¾ "

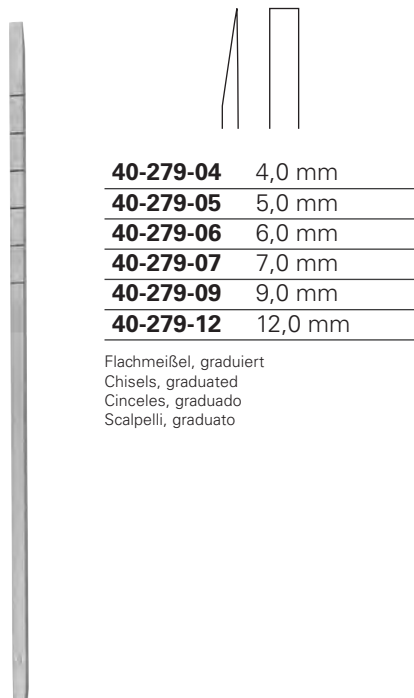


<b>40-278-04</b>	4,0 mm
<b>40-278-06</b>	6,0 mm
<b>40-278-08</b>	8,0 mm
<b>40-278-10</b>	10,0 mm
<b>40-278-12</b>	12,0 mm

Osteotome, graduiert  
 Osteotomes, graduated  
 Osteótomo, graduado  
 Osteotomo, graduato

### COTTLE

**40-278-04 - 40-278-12** 18,0 cm, 7 "

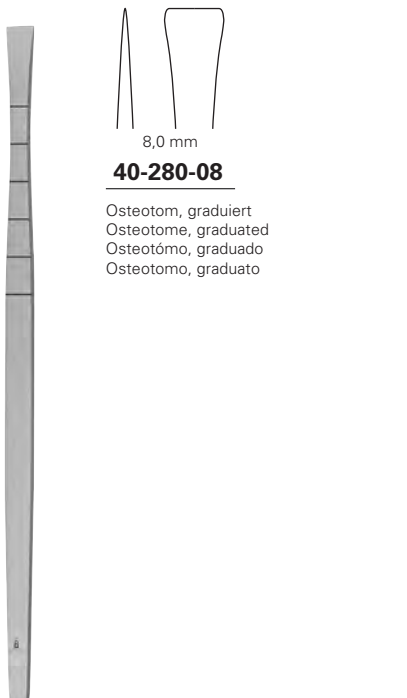


<b>40-279-04</b>	4,0 mm
<b>40-279-05</b>	5,0 mm
<b>40-279-06</b>	6,0 mm
<b>40-279-07</b>	7,0 mm
<b>40-279-09</b>	9,0 mm
<b>40-279-12</b>	12,0 mm

Flachmeißel, graduiert  
 Chisels, graduated  
 Cinceles, graduado  
 Scalpelli, graduato

### COTTLE

**40-279-04 - 40-279-12** 18,0 cm, 7 "



8,0 mm  
**40-280-08**

Osteotom, graduiert  
 Osteotome, graduated  
 Osteótomo, graduado  
 Osteotomo, graduato

### COTTLE

**40-280-08** 18,0 cm, 7 "

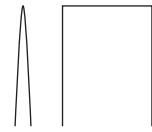


<b>40-282-08</b>	8,0 mm
<b>40-282-10</b>	10,0 mm
<b>40-282-12</b>	12,0 mm
<b>40-282-15</b>	15,0 mm
<b>40-282-20</b>	20,0 mm
<b>40-282-25</b>	25,0 mm

Flachmeißel  
 Chisels  
 Cinceles  
 Scalpelli

**STILLE**

**40-282-08 - 40-282-25** 20,0 cm, 8 "

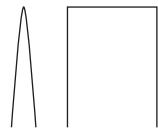


<b>40-286-10</b>	10,0 mm
<b>40-286-12</b>	12,0 mm
<b>40-286-15</b>	15,0 mm
<b>40-286-20</b>	20,0 mm
<b>40-286-25</b>	25,0 mm

Osteotome, fein  
 Osteotomes, delicate  
 Osteótomos, fino  
 Osteotomi, fino

**STILLE**

**40-286-10 - 40-286-25** 20,0 cm, 8 "

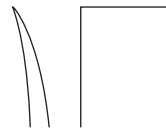


<b>40-284-06</b>	6,0 mm
<b>40-284-08</b>	8,0 mm
<b>40-284-10</b>	10,0 mm
<b>40-284-12</b>	12,0 mm
<b>40-284-15</b>	15,0 mm
<b>40-284-20</b>	20,0 mm
<b>40-284-25</b>	25,0 mm
<b>40-284-30</b>	30,0 mm

Osteotome  
 Osteotomes  
 Osteótomos  
 Osteotomi

**STILLE**

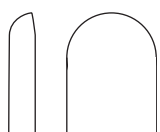
**40-284-06 - 40-285-30** 20,0 cm, 8 "



<b>40-285-06</b>	6,0 mm
<b>40-285-08</b>	8,0 mm
<b>40-285-10</b>	10,0 mm
<b>40-285-12</b>	12,0 mm
<b>40-285-15</b>	15,0 mm
<b>40-285-20</b>	20,0 mm
<b>40-285-25</b>	25,0 mm
<b>40-285-30</b>	30,0 mm

Osteotome  
 Osteotomes  
 Osteótomos  
 Osteotomi

Osteotome, Hohlmeißel  
 Osteotomes, Gouges  
 Osteótomos, Gubias  
 Osteotomi, Sgorbie

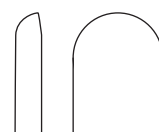


<b>40-288-10</b>	10,0 mm
<b>40-288-12</b>	12,0 mm
<b>40-288-15</b>	15,0 mm
<b>40-288-20</b>	20,0 mm
<b>40-288-25</b>	25,0 mm

Hohlmeißel  
 Gouges  
 Gubias  
 Sgorbie

### STILLE

**40-288-10 - 40-288-25** 20,0 cm, 8"

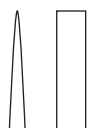


<b>40-289-10</b>	10,0 mm
<b>40-289-15</b>	15,0 mm

Hohlmeißel  
 Gouges  
 Gubias  
 Sgorbie

### WALTER

**40-289-10 - 40-289-15** 20,0 cm, 8"



<b>40-290-02</b>	2,0 mm
<b>40-290-03</b>	3,0 mm
<b>40-290-05</b>	5,0 mm
<b>40-290-07</b>	7,0 mm
<b>40-290-10</b>	10,0 mm
<b>40-290-14</b>	14,0 mm
<b>40-290-16</b>	16,0 mm

Osteotome  
 Osteotomes  
 Osteótomos  
 Osteotomi

### TESSIER

**40-290-02 - 40-290-16** 16,0 cm, 6 ¼"

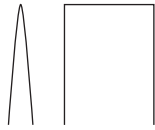


<b>40-291-05</b>	5,0 mm
<b>40-291-07</b>	7,0 mm
<b>40-291-10</b>	10,0 mm

Osteotome  
 Osteotomes  
 Osteótomos  
 Osteotomi

### TESSIER

**40-291-05 - 40-291-10** 16,0 cm, 6 ¼"

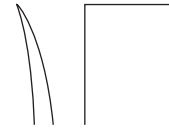


<b>40-292-04</b>	4,0 mm
<b>40-292-06</b>	6,0 mm
<b>40-292-08</b>	8,0 mm
<b>40-292-10</b>	10,0 mm
<b>40-292-13</b>	13,0 mm
<b>40-292-15</b>	15,0 mm
<b>40-292-18</b>	18,0 mm
<b>40-292-20</b>	20,0 mm
<b>40-292-25</b>	25,0 mm
<b>40-292-30</b>	30,0 mm
<b>40-292-38</b>	38,0 mm
<b>40-292-44</b>	44,0 mm
<b>40-292-50</b>	50,0 mm

Osteotome  
Osteotomes  
Osteótomos  
Osteotomi

### LAMBOTTE

**40-292-04 - 40-292-50** 24,0 cm, 9 ½"

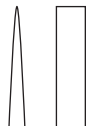


<b>40-293-04</b>	4,0 mm
<b>40-293-06</b>	6,0 mm
<b>40-293-08</b>	8,0 mm
<b>40-293-10</b>	10,0 mm
<b>40-293-13</b>	13,0 mm
<b>40-293-15</b>	15,0 mm
<b>40-293-18</b>	18,0 mm
<b>40-293-20</b>	20,0 mm
<b>40-293-25</b>	25,0 mm
<b>40-293-30</b>	30,0 mm
<b>40-293-38</b>	38,0 mm
<b>40-293-44</b>	44,0 mm
<b>40-293-50</b>	50,0 mm

Osteotome  
Osteotomes  
Osteótomos  
Osteotomi

### LAMBOTTE

**40-293-04 - 40-293-50** 24,0 cm, 9 ½"

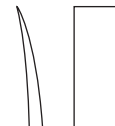


<b>40-294-04</b>	4,0 mm
<b>40-294-06</b>	6,0 mm
<b>40-294-08</b>	8,0 mm
<b>40-294-10</b>	10,0 mm
<b>40-294-12</b>	12,0 mm
<b>40-294-14</b>	14,0 mm
<b>40-294-16</b>	16,0 mm

Osteotome  
Osteotomes  
Osteótomos  
Osteotomi

### DAUTREY-MUNRO

**40-294-04 - 40-294-16** 16,0 cm, 6 ¼"

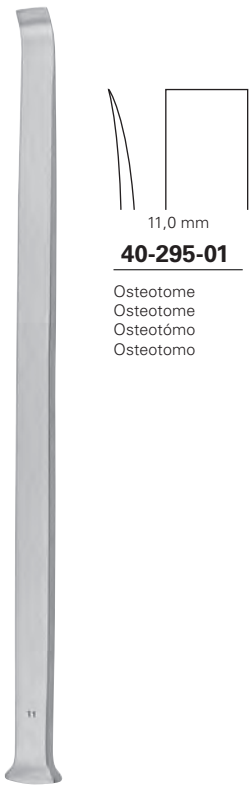


<b>40-294-74</b>	4,0 mm
<b>40-294-76</b>	6,0 mm
<b>40-294-78</b>	8,0 mm
<b>40-294-80</b>	10,0 mm
<b>40-294-82</b>	12,0 mm
<b>40-294-84</b>	14,0 mm
<b>40-294-86</b>	16,0 mm

Osteotome  
Osteotomes  
Osteótomos  
Osteotomi

### DAUTREY-MUNRO

**40-294-74 - 40-294-86** 16,0 cm, 6 ¼"



11,0 mm  
**40-295-01**  
 Osteotome  
 Osteotome  
 Osteótomo  
 Osteotomo

**OBWEGESER**

**40-295-01** 23,5 cm, 9 ¼ "



**40-295-08** 8,0 mm  
**40-295-12** 12,0 mm  
**40-295-16** 16,0 mm  
 Keilosteotome  
 Wedge osteotomes  
 Osteótomos de cuña  
 Osteotomi a forma di cuneo



**OBWEGESER**

**40-295-08 - 40-295-16** 22,0 cm, 8 ¾ "



**40-295-21** 7,0 mm  
**40-295-22** 10,0 mm  
 Spaltungsosteotome  
 Splitting osteotomes  
 Osteótomos hendedores  
 Osteotomi fenditori



**OBWEGESER**

**40-295-21 - 40-295-22** 22,0 cm, 8 ¾ "

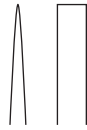


**40-296-01** 8,0 mm  
**40-296-02** 12,0 mm  
**40-296-03** 16,0 mm  
**40-296-04** 20,0 mm  
 Blattosteotome  
 Blade osteotomes  
 Osteótomos de hoja  
 Osteotomi a forma di lama



**OBWEGESER**

**40-296-01 - 40-296-04** 22,0 cm, 8 ¾ "

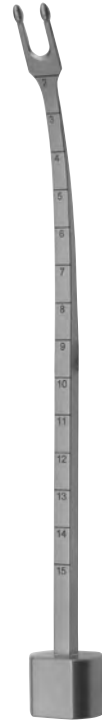


<b>40-295-25</b>	3,0 mm
<b>40-295-40</b>	4,0 mm
<b>40-295-65</b>	6,5 mm

Interdentale Osteotome  
Interdental osteotomes  
Osteótomos interdientales  
Osteotomi interdientai

**OBWEGESER**

**40-295-25 - 40-295-65** 15,0 cm, 6 "

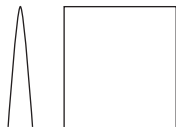


<b>40-297-24</b>	4,0 mm
<b>40-297-26</b>	6,0 mm
<b>40-297-28</b>	8,0 mm

Osteotome, graduiert  
Osteotomes, graduated  
Osteótomos, graduado  
Osteotomi, graduato

**OBWEGESER**

**40-297-24 - 40-297-28** 18,5 cm, 7 ¼ "

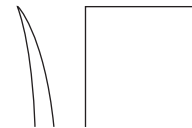


<b>40-296-10</b>	10,0 mm
<b>40-296-15</b>	15,0 mm
<b>40-296-20</b>	20,0 mm
<b>40-296-30</b>	30,0 mm

Osteotome  
Osteotomes  
Osteótomos  
Osteotomi

**TESSIER**

**40-296-10 - 40-296-30** 20,0 cm, 8 "

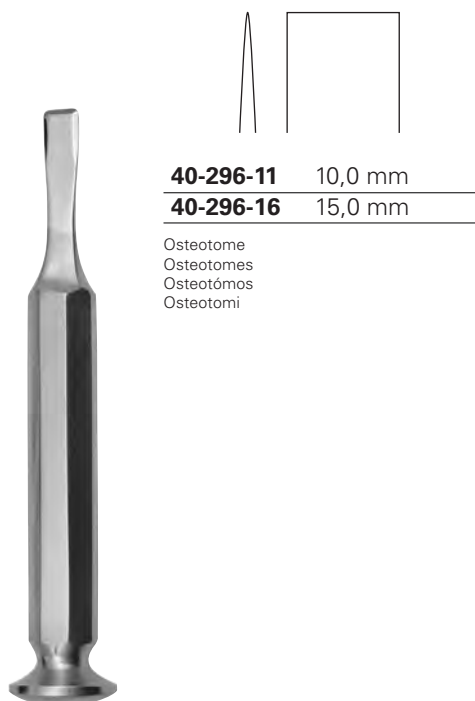


<b>40-297-10</b>	10,0 mm
<b>40-297-15</b>	15,0 mm

Osteotome  
Osteotomes  
Osteótomos  
Osteotomi

**TESSIER**

**40-297-10 - 40-297-15** 20,0 cm, 8 "



<b>40-296-11</b>	10,0 mm
<b>40-296-16</b>	15,0 mm

Osteotome  
 Osteotomes  
 Osteótomos  
 Osteotomi

### TESSIER

**40-296-11 - 40-296-16** 16,0 cm, 6 ¼"

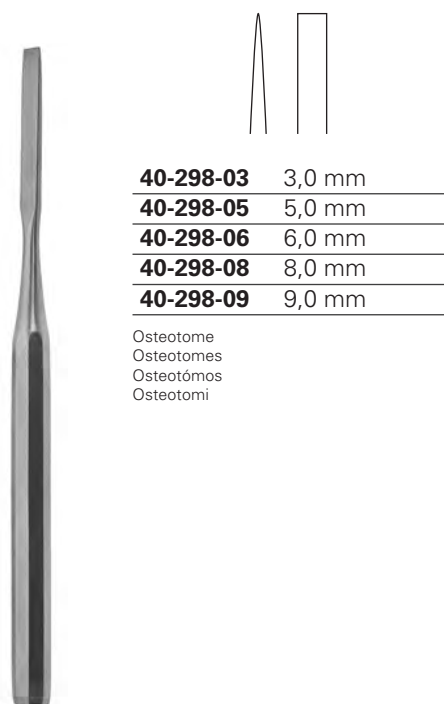


<b>40-297-11</b>	10,0 mm
<b>40-297-16</b>	15,0 mm

Osteotome  
 Osteotomes  
 Osteótomos  
 Osteotomi

### TESSIER

**40-297-11 - 40-297-16** 16,0 cm, 6 ¼"

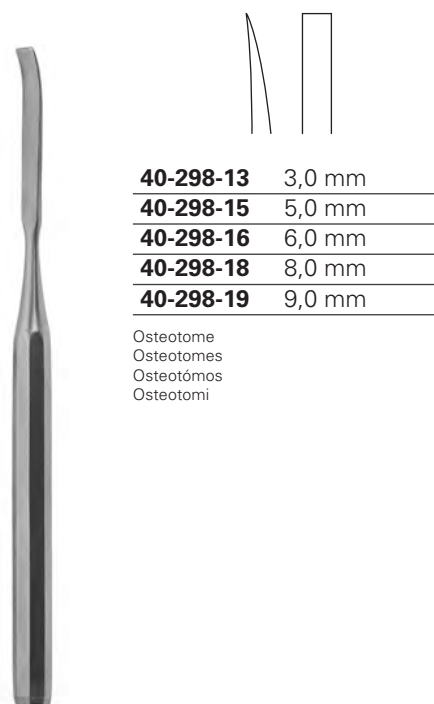


<b>40-298-03</b>	3,0 mm
<b>40-298-05</b>	5,0 mm
<b>40-298-06</b>	6,0 mm
<b>40-298-08</b>	8,0 mm
<b>40-298-09</b>	9,0 mm

Osteotome  
 Osteotomes  
 Osteótomos  
 Osteotomi

### HOKE

**40-298-03 - 40-298-09** 17,0 cm, 6 ¾"

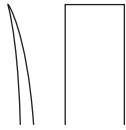


<b>40-298-13</b>	3,0 mm
<b>40-298-15</b>	5,0 mm
<b>40-298-16</b>	6,0 mm
<b>40-298-18</b>	8,0 mm
<b>40-298-19</b>	9,0 mm

Osteotome  
 Osteotomes  
 Osteótomos  
 Osteotomi

### HOKE

**40-298-13 - 40-298-19** 17,0 cm, 6 ¾"

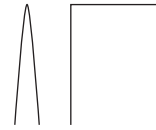


<b>40-299-08</b>	8,0 mm
<b>40-299-10</b>	10,0 mm

Osteotome  
 Osteotomes  
 Osteótomos  
 Osteotomi

**NIEDERDELMANN**

**40-299-08 - 40-299-10** 25,0 cm, 9 3/4"

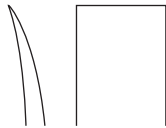


<b>40-300-06</b>	6,0 mm
<b>40-300-09</b>	9,0 mm
<b>40-300-13</b>	13,0 mm
<b>40-300-16</b>	16,0 mm
<b>40-300-19</b>	19,0 mm
<b>40-300-25</b>	25,0 mm
<b>40-300-32</b>	32,0 mm

Osteotome  
 Osteotomes  
 Osteótomos  
 Osteotomi

**HIBBS**

**40-300-06 - 40-300-32** 24,5 cm, 9 2/3"



<b>40-301-06</b>	6,0 mm
<b>40-301-13</b>	13,0 mm
<b>40-301-19</b>	19,0 mm
<b>40-301-25</b>	25,0 mm
<b>40-301-32</b>	32,0 mm

Osteotome  
 Osteotomes  
 Osteótomos  
 Osteotomi

**HIBBS**

**40-301-06 - 40-301-32** 24,5 cm, 9 2/3"



<b>40-302-06</b>	6,0 mm
<b>40-302-13</b>	13,0 mm
<b>40-302-19</b>	19,0 mm
<b>40-302-25</b>	25,0 mm
<b>40-302-32</b>	32,0 mm

Flachmeißel  
 Chisels  
 Cinceles  
 Scalpelli

**HIBBS**

**40-302-06 - 40-302-32** 24,5 cm, 9 2/3"



Osteotome, Hohlmeißel  
 Osteotomes, Gouges  
 Osteótomos, Gubias  
 Osteotomi, Sgorbie

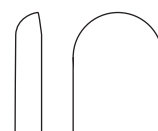


<b>40-303-06</b>	6,0 mm
<b>40-303-13</b>	13,0 mm
<b>40-303-19</b>	19,0 mm
<b>40-303-25</b>	25,0 mm
<b>40-303-32</b>	32,0 mm

Hohlmeißel  
 Gouges  
 Gubias  
 Sgorbie

### HIBBS

**40-303-06 - 40-303-32** 24,5 cm, 9 2/3 "

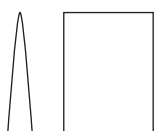


<b>40-304-06</b>	6,0 mm
<b>40-304-13</b>	13,0 mm
<b>40-304-19</b>	19,0 mm
<b>40-304-25</b>	25,0 mm
<b>40-304-32</b>	32,0 mm

Hohlmeißel  
 Gouges  
 Gubias  
 Sgorbie

### HIBBS

**40-304-06 - 40-304-32** 24,5 cm, 9 2/3 "

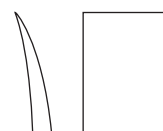


<b>40-306-06</b>	6,0 mm
<b>40-306-09</b>	9,0 mm
<b>40-306-13</b>	13,0 mm
<b>40-306-16</b>	16,0 mm
<b>40-306-19</b>	19,0 mm
<b>40-306-25</b>	25,0 mm
<b>40-306-32</b>	32,0 mm

Osteotome  
 Osteotomes  
 Osteótomos  
 Osteotomi

### SMITH-PETERSEN

**40-306-06 - 40-306-32** 20,5 cm, 8 "

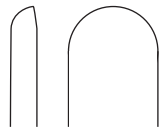


<b>40-307-06</b>	6,0 mm
<b>40-307-09</b>	9,0 mm
<b>40-307-13</b>	13,0 mm
<b>40-307-16</b>	16,0 mm
<b>40-307-19</b>	19,0 mm
<b>40-307-25</b>	25,0 mm
<b>40-307-32</b>	32,0 mm

Osteotome  
 Osteotomes  
 Osteótomos  
 Osteotomi

### SMITH-PETERSEN

**40-307-06 - 40-307-32** 20,5 cm, 8 "

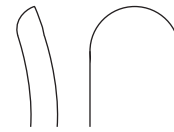


<b>40-308-06</b>	6,0 mm
<b>40-308-09</b>	9,0 mm
<b>40-308-13</b>	13,0 mm
<b>40-308-16</b>	16,0 mm
<b>40-308-19</b>	19,0 mm
<b>40-308-25</b>	25,0 mm
<b>40-308-32</b>	32,0 mm

Hohlmeißel  
 Gouges  
 Gubias  
 Sgorbie

**SMITH-PETERSEN**

**40-308-06 - 40-308-32** 20,5 cm, 8"



<b>40-309-06</b>	6,0 mm
<b>40-309-09</b>	9,0 mm
<b>40-309-13</b>	13,0 mm
<b>40-309-16</b>	16,0 mm
<b>40-309-19</b>	19,0 mm
<b>40-309-25</b>	25,0 mm
<b>40-309-32</b>	32,0 mm

Hohlmeißel  
 Gouges  
 Gubias  
 Sgorbie

**SMITH-PETERSEN**

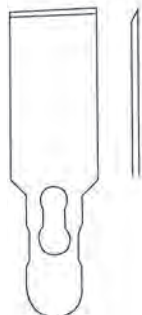
**40-309-06 - 40-309-32** 20,5 cm, 8"



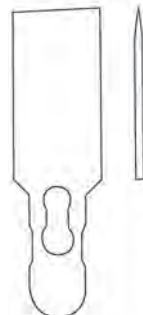
**40-310-80**

Schlüssel  
 Key  
 Llave  
 Chiave

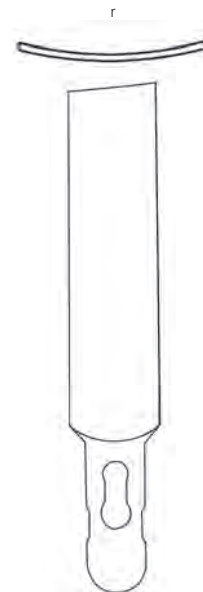
Handgriff mit Schlüssel  
 Handle with key  
 Mango con llave  
 Manico con chiave



Flachmeißel  
 Chisel  
 Cincele  
 Scalpelli



Osteotome  
 Osteotomes  
 Osteótomos  
 Osteotomi



Hohlmeißel  
 Gouge  
 Gubia  
 Sgorbie

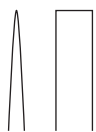


<b>40-310-01</b>	5,0 mm
<b>40-310-02</b>	10,0 mm
<b>40-310-03</b>	16,0 mm
<b>40-310-04</b>	25,0 mm

<b>40-310-05</b>	5,0 mm
<b>40-310-06</b>	10,0 mm
<b>40-310-07</b>	16,0 mm
<b>40-310-08</b>	25,0 mm

<b>40-310-09</b>	r = 50,0 mm
<b>40-310-10</b>	r = 60,0 mm
<b>40-310-11</b>	r = 70,0 mm

**40-310-00** 18,5 cm, 7 1/4"



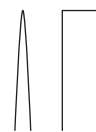
<b>40-316-04</b>	4,0 mm
<b>40-316-06</b>	6,0 mm
<b>40-316-08</b>	8,0 mm
<b>40-316-10</b>	10,0 mm
<b>40-316-12</b>	12,0 mm
<b>40-316-15</b>	15,0 mm

Osteotome  
 Osteotomes  
 Osteótomos  
 Osteotomi



### LEXER-MINI

**40-316-04 - 40-316-15** 18,5 cm, 7 ¼ "



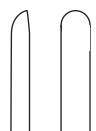
<b>40-316-04 P</b>	4,0 mm
<b>40-316-06 P</b>	6,0 mm
<b>40-316-08 P</b>	8,0 mm
<b>40-316-10 P</b>	10,0 mm
<b>40-316-12 P</b>	12,0 mm

Osteotome  
 Osteotomes  
 Osteótomos  
 Osteotomi



### LEXER-MINI

**40-316-04 P - 40-316-12 P** 18,5 cm, 7 ¼ "



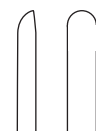
<b>40-318-04</b>	4,0 mm
<b>40-318-06</b>	6,0 mm
<b>40-318-08</b>	8,0 mm
<b>40-318-10</b>	10,0 mm
<b>40-318-12</b>	12,0 mm

Hohlmeißel  
 Gouges  
 Gubias  
 Sgorbie



### LEXER-MINI

**40-318-04 - 40-318-12** 18,5 cm, 7 ¼ "



<b>40-318-04 P</b>	4,0 mm
<b>40-318-06 P</b>	6,0 mm
<b>40-318-08 P</b>	8,0 mm
<b>40-318-10 P</b>	10,0 mm
<b>40-318-12 P</b>	12,0 mm

Hohlmeißel  
 Gouges  
 Gubias  
 Sgorbie



### LEXER-MINI

**40-318-04 P - 40-318-12 P** 18,5 cm, 7 ¼ "



<b>40-320-01</b>	10,0 mm
<b>40-320-02</b>	15,0 mm
<b>40-320-03</b>	20,0 mm

Flachmeißel  
Chisels  
Cinceles  
Scalpelli



**LEXER**

**40-320-01 - 40-320-03** 20,0 cm, 8"



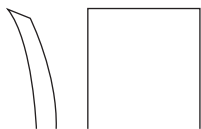
<b>40-320-01 P</b>	10,0 mm
<b>40-320-02 P</b>	15,0 mm
<b>40-320-03 P</b>	20,0 mm

Flachmeißel  
Chisels  
Cinceles  
Scalpelli



**LEXER**

**40-320-01 P - 40-320-03 P** 20,0 cm, 8"



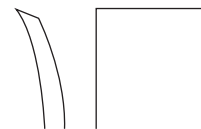
<b>40-321-01</b>	10,0 mm
<b>40-321-02</b>	15,0 mm
<b>40-321-03</b>	20,0 mm

Flachmeißel  
Chisels  
Cinceles  
Scalpelli



**LEXER**

**40-321-01 - 40-321-03** 20,0 cm, 8"



<b>40-321-01 P</b>	10,0 mm
<b>40-321-02 P</b>	15,0 mm
<b>40-321-03 P</b>	20,0 mm

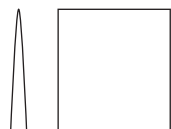
Flachmeißel  
Chisels  
Cinceles  
Scalpelli



**LEXER**

**40-321-01 P - 40-321-03 P** 20,0 cm, 8"

Osteotome, Hohlmeißel  
 Osteotomes, Gouges  
 Osteótomos, Gubias  
 Osteotomi, Sgorbie



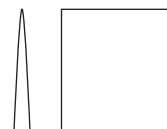
<b>40-320-05</b>	5,0 mm
<b>40-320-07</b>	7,0 mm
<b>40-320-10</b>	10,0 mm
<b>40-320-12</b>	12,0 mm
<b>40-320-15</b>	15,0 mm
<b>40-320-20</b>	20,0 mm
<b>40-320-25</b>	25,0 mm
<b>40-320-30</b>	30,0 mm

Osteotome  
 Osteotomes  
 Osteótomos  
 Osteotomi



**LEXER**

**40-320-05 - 40-320-30** 22,0 cm, 8 ¾ "



<b>40-320-05 P</b>	5,0 mm
<b>40-320-07 P</b>	7,0 mm
<b>40-320-10 P</b>	10,0 mm
<b>40-320-12 P</b>	12,0 mm
<b>40-320-15 P</b>	15,0 mm
<b>40-320-20 P</b>	20,0 mm
<b>40-320-25 P</b>	25,0 mm
<b>40-320-30 P</b>	30,0 mm

Osteotome  
 Osteotomes  
 Osteótomos  
 Osteotomi



**LEXER**

**40-320-05 P - 40-320-30 P** 22,0 cm, 8 ¾ "



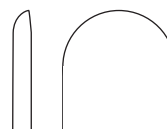
<b>40-322-05</b>	5,0 mm
<b>40-322-07</b>	7,0 mm
<b>40-322-10</b>	10,0 mm
<b>40-322-12</b>	12,0 mm
<b>40-322-15</b>	15,0 mm
<b>40-322-20</b>	20,0 mm
<b>40-322-25</b>	25,0 mm
<b>40-322-30</b>	30,0 mm

Hohlmeißel  
 Gouges  
 Gubias  
 Sgorbie



**LEXER**

**40-322-05 - 40-322-30** 22,0 cm, 8 ¾ "



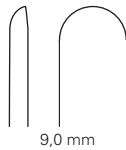
<b>40-322-05 P</b>	5,0 mm
<b>40-322-07 P</b>	7,0 mm
<b>40-322-10 P</b>	10,0 mm
<b>40-322-12 P</b>	12,0 mm
<b>40-322-15 P</b>	15,0 mm
<b>40-322-20 P</b>	20,0 mm
<b>40-322-25 P</b>	25,0 mm
<b>40-322-30 P</b>	30,0 mm

Hohlmeißel  
 Gouges  
 Gubias  
 Sgorbie



**LEXER**

**40-322-05 P - 40-322-30 P** 22,0 cm, 8 ¾ "



**40-324-09**

Hohlmeißel zum Freilegen  
abgebrochener Schrauben

Gouge for removing of  
broken screws

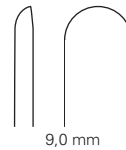
Gubia para exteriorizar  
tornillos truncados

Sgorbie per rimuovere  
viti rotte



**LEXER**

**40-324-09** 22,0 cm, 8 3/4 "



**40-324-09 P**

Hohlmeißel zum Freilegen  
abgebrochener Schrauben

Gouge for removing of  
broken screws

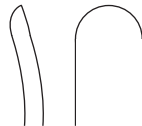
Gubia para exteriorizar  
tornillos truncados

Sgorbie per rimuovere  
viti rotte



**LEXER**

**40-324-09 P** 22,0 cm, 8 3/4 "



**40-325-55** 5,5 mm

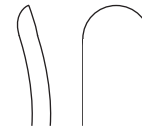
**40-325-90** 9,0 mm

Hohlmeißel für Skoliose Operationen  
Gouges for scoliosis operations  
Gubias para operaciones scoliosis  
Sgorbie per interventi di scoliosi



**ZIELKE**

**40-325-55 - 40-325-90** 23,0 cm, 9 "



**40-325-55 P** 5,5 mm

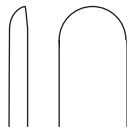
**40-325-90 P** 9,0 mm

Hohlmeißel für Skoliose Operationen  
Gouges for scoliosis operations  
Gubias para operaciones scoliosis  
Sgorbie per interventi di scoliosi



**ZIELKE**

**40-325-55 P - 40-325-90 P** 23,0 cm, 9 "



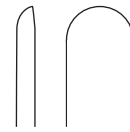
<b>40-326-05</b>	5,0 mm
<b>40-326-10</b>	10,0 mm
<b>40-326-15</b>	15,0 mm

Spongiosa Hohlmeißel  
Spongiosa gouges  
Gubias de esponjosa  
Sgorbie per tessuto osseo spugnoso



**LEXER**

**40-326-05 - 40-326-15** 25,0 cm, 9 3/4 "



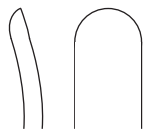
<b>40-326-05 P</b>	5,0 mm
<b>40-326-10 P</b>	10,0 mm
<b>40-326-15 P</b>	15,0 mm

Spongiosa Hohlmeißel  
Spongiosa gouges  
Gubias de esponjosa  
Sgorbie per tessuto osseo spugnoso



**LEXER**

**40-326-05 P - 40-326-15 P** 25,0 cm, 9 3/4 "



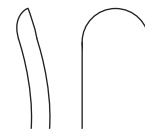
<b>40-327-05</b>	5,0 mm
<b>40-327-10</b>	10,0 mm
<b>40-327-15</b>	15,0 mm

Spongiosa Hohlmeißel  
Spongiosa gouges  
Gubias de esponjosa  
Sgorbie per tessuto osseo spugnoso



**LEXER**

**40-327-05 - 40-327-15** 25,0 cm, 9 3/4 "



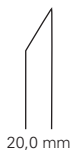
<b>40-327-05 P</b>	5,0 mm
<b>40-327-10 P</b>	10,0 mm
<b>40-327-15 P</b>	15,0 mm

Spongiosa Hohlmeißel  
Spongiosa gouges  
Gubias de esponjosa  
Sgorbie per tessuto osseo spugnoso



**LEXER**

**40-327-05 P - 40-327-15 P** 25,0 cm, 9 3/4 "



20,0 mm

**40-328-20**

Flachmeißel  
Chisel  
Cincele  
Scalpelli



20,0 mm

**40-328-20 P**

Flachmeißel  
Chisel  
Cincele  
Scalpelli



16,0 mm

**40-329-16**

Flachmeißel  
Chisel  
Cincele  
Scalpelli



16,0 mm

**40-329-16 P**

Flachmeißel  
Chisel  
Cincele  
Scalpelli



**40-328-20** 24,5 cm, 9 3/4"

**40-328-20 P** 22,0 cm, 8 3/4"

**40-329-16** 26,5 cm, 10 1/2"

**40-329-16 P** 26,5 cm, 10 1/2"





15,0 mm  
**40-330-15**  
 Osteotom  
 Osteotome  
 Osteótomo  
 Osteotomi



15,0 mm  
**40-330-15 P**  
 Osteotom  
 Osteotome  
 Osteótomo  
 Osteotomi



10,0 mm  
**40-331-10**  
 15,0 mm  
**40-331-15**  
 Osteotome  
 Osteotomes  
 Osteótomo  
 Osteotomi



10,0 mm  
**40-331-10 P**  
 15,0 mm  
**40-331-15 P**  
 Osteotome  
 Osteotomes  
 Osteótomo  
 Osteotomi



**LEXER**

**40-330-15** 27,5 cm, 10 3/4"

**LEXER**

**40-330-15 P** 27,5 cm, 10 3/4"

**LEXER**

**40-331-10** 27,5 cm, 10 3/4"  
**40-331-15** 27,5 cm, 10 3/4"

**LEXER**

**40-331-10 P** 27,5 cm, 10 3/4"  
**40-331-15 P** 27,5 cm, 10 3/4"



**LEXER**

**40-333-10** 27,5 cm, 10 3/4"  
**40-333-15** 27,5 cm, 10 3/4"

**LEXER**

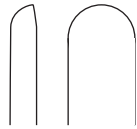
**40-333-10 P** 27,5 cm, 10 3/4"  
**40-333-15 P** 27,5 cm, 10 3/4"

**LEXER**

**40-334-07** 27,5 cm, 10 3/4"  
**40-334-10** 27,5 cm, 10 3/4"

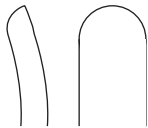
**LEXER**

**40-334-07 P** 27,5 cm, 10 3/4"  
**40-334-10 P** 27,5 cm, 10 3/4"



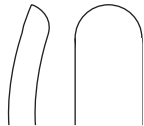
<b>40-336-09</b>	9,0 mm
<b>40-336-15</b>	10,0 mm
<b>40-336-30</b>	30,0 mm

Hohlmeißel  
 Gouges  
 Gubias  
 Sgorbie



<b>40-337-09</b>	9,0 mm
<b>40-337-15</b>	10,0 mm
<b>40-337-30</b>	30,0 mm

Hohlmeißel  
 Gouges  
 Gubias  
 Sgorbie



<b>40-339-09</b>	9,0 mm
<b>40-339-15</b>	10,0 mm
<b>40-339-30</b>	30,0 mm

Hohlmeißel  
 Gouges  
 Gubias  
 Sgorbie



**40-340-01**

Meißel  
 Chisel  
 Cinceles  
 Scalpelli



**40-340-02**

Meißel  
 Chisel  
 Cinceles  
 Scalpelli

**WAGNER**

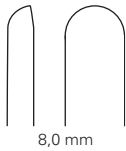
**40-336-09 - 40-339-30** 34,0 cm, 13 1/2 "

**BRUNETTI**

**40-340-01** 28,0 cm, 11 "

**BRUNETTI**

**40-340-02** 28,0 cm, 11 "



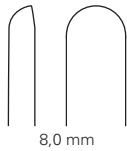
**40-341-01**

Spinal Hohlmeißel  
Spinal gouge  
Gubia espinal  
Sgorbie spinali



**COBB**

**40-341-01** 27,0 cm, 10<sup>3</sup>/<sub>4</sub>"



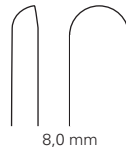
**40-341-02**

Spinal Hohlmeißel  
Spinal gouge  
Gubia espinal  
Sgorbie spinali



**COBB**

**40-341-02** 27,0 cm, 10<sup>3</sup>/<sub>4</sub>"



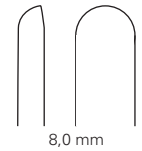
**40-341-03**

Spinal Hohlmeißel  
Spinal gouge  
Gubia espinal  
Sgorbie spinali



**COBB**

**40-341-03** 27,0 cm, 10<sup>3</sup>/<sub>4</sub>"



**40-341-04**

Spinal Hohlmeißel  
Spinal gouge  
Gubia espinal  
Sgorbie spinali



**COBB**

**40-341-04** 27,0 cm, 10<sup>3</sup>/<sub>4</sub>"



## DAHMEN

**40-342-04 - 40-343-25** 30,0 cm, 11 3/4"



## DAHMEN

**40-344-04 - 40-345-25** 30,0 cm, 11 3/4"



**40-348-01**

Elevator  
 Elevator  
 Elevator  
 Elevatori

Griff aus Titanium  
 Titanium handle  
 Mango de titanio  
 Manico di titanio



**VICKERS**

**40-348-01** 17,0 cm, 6 <sup>3</sup>/<sub>4</sub> "



**40-348-02**

Dissektor  
 Dissector  
 Dissectore  
 Dissettori

Griff aus Titanium  
 Titanium handle  
 Mango de titanio  
 Manico di titanio



**VICKERS**

**40-348-02** 17,0 cm, 6 <sup>3</sup>/<sub>4</sub> "

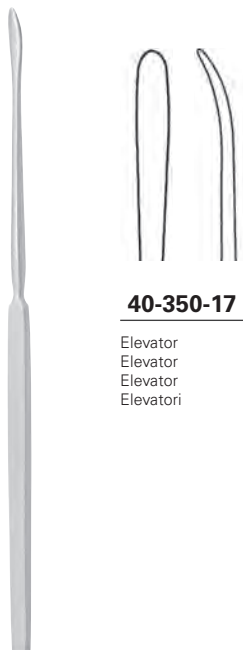


**40-349-20**

Raspatorium  
 Raspatory  
 Periostótomó  
 Periostotomi

**SEWALL**

**40-349-20** 20,0 cm, 8 "



**40-350-17**

Elevator  
 Elevator  
 Elevator  
 Elevatori

**40-350-17** 17,0 cm, 6 <sup>3</sup>/<sub>4</sub> "

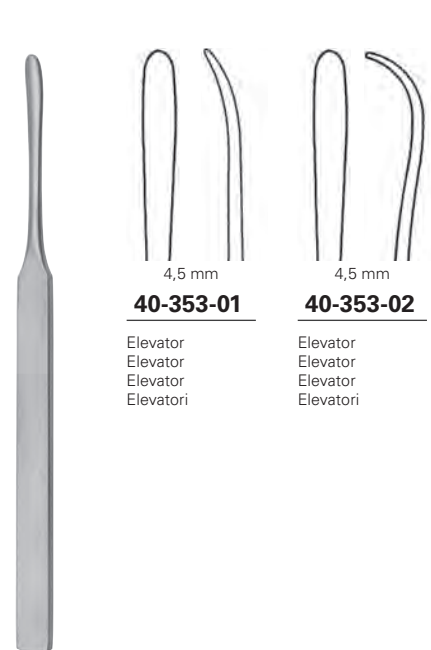


**40-351-14**

Raspatorium  
 Raspatory  
 Periostótomó  
 Periostotomi

**PARTSCH-LANGE**

**40-351-14** 14,5 cm, 5 <sup>3</sup>/<sub>4</sub> "



**40-353-01**

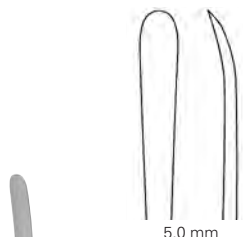
**40-353-02**

Elevator  
 Elevator  
 Elevator  
 Elevatori

Elevator  
 Elevator  
 Elevator  
 Elevatori

**KOENIG**

**40-353-01 - 40-353-02** 15,5 cm, 6 <sup>1</sup>/<sub>8</sub> "



5,0 mm

**40-353-15**

Raspatorium  
Raspatory  
Periostótomo  
Periostotomi



### KOENIG

**40-353-15** 15,5 cm, 6 1/8"



8,0 mm

**40-354-15**

Raspatorium  
Raspatory  
Periostótomo  
Periostotomi



### TRELAT

**40-354-15** 15,0 cm, 6"



4,2 mm

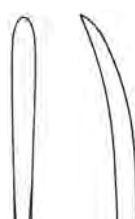
**40-355-14**

Raspatorium  
Raspatory  
Periostótomo  
Periostotomi



### WILLIGER

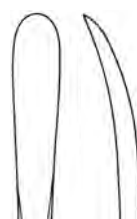
**40-355-14** 13,0 cm, 5 1/8"



3,0 mm

**40-355-15**

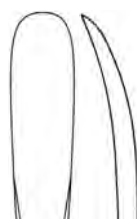
Raspatorium  
Raspatory  
Periostótomo  
Periostotomi



6,0 mm

**40-355-16**

Raspatorium  
Raspatory  
Periostótomo  
Periostotomi



8,0 mm

**40-355-17**

Raspatorium  
Raspatory  
Periostótomo  
Periostotomi

### WILLIGER

**40-355-15 - 40-355-17** 16,0 cm, 6 1/4"



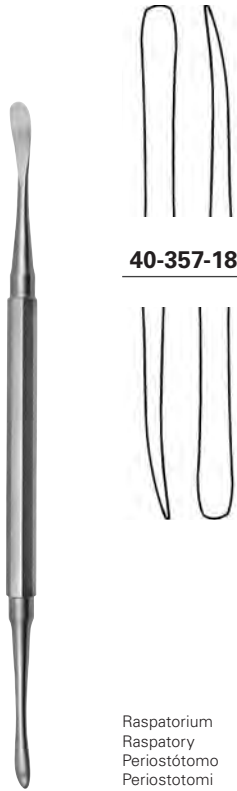
4,0 mm

**40-356-17**

Raspatorium  
Raspatory  
Periostótomo  
Periostotomi

### JOSEPH

**40-356-17** 17,0 cm, 6 3/4"



**40-357-18**

Raspatorium  
 Raspatory  
 Periostótomos  
 Periostotomi

**MOLT**

**40-357-18** 18,0 cm, 7"



**40-358-19**

stumpf  
 blunt  
 romo  
 smusso

Elevator  
 Elevator  
 Elevator  
 Elevatori

**FREER**

**40-358-19** 19,0 cm, 7 1/2"



**40-359-19**

scharf  
 sharp  
 agudo  
 acuto

Elevator  
 Elevator  
 Elevator  
 Elevatori

**FREER**

**40-359-19** 19,0 cm, 7 1/2"



**40-361-16**

Raspatorium  
 Raspatory  
 Periostótomos  
 Periostotomi

**WULLSTEIN**

**40-361-16** 16,0 cm, 6 1/4"



**40-361-17**

Raspatorium  
 Raspatory  
 Periostótomos  
 Periostotomi

**WULLSTEIN**

**40-361-17** 16,0 cm, 6 1/4"



**40-362-16**

Raspatorium  
 Raspatory  
 Periostótomos  
 Periostotomi

**LEMPERT**

**40-362-16** 16,0 cm, 6 1/4"



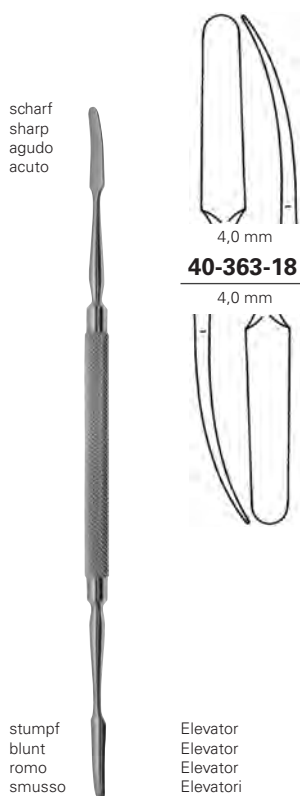
**40-362-19**

Raspatorium  
 Raspatory  
 Periostótomos  
 Periostotomi

**LEMPERT**

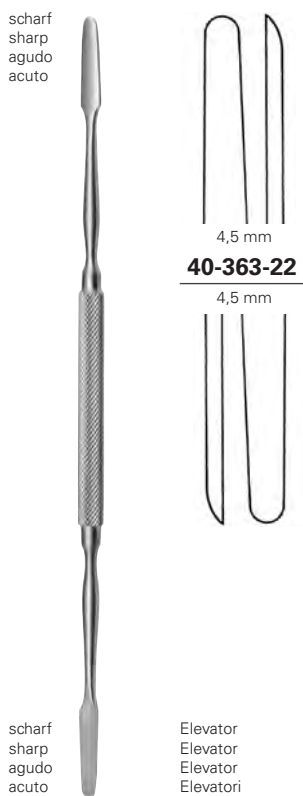
**40-362-19** 16,0 cm, 6 1/4"





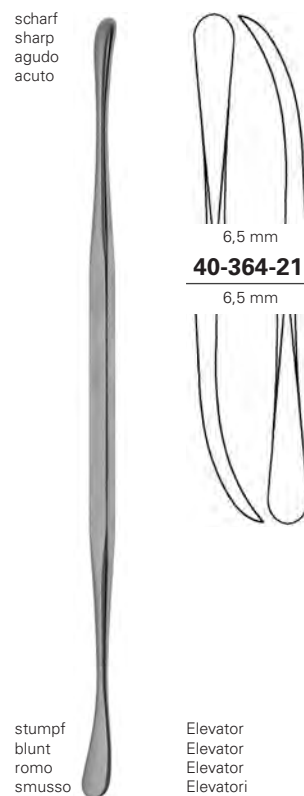
**KILLIAN**

**40-363-18** 18,0 cm, 7 "



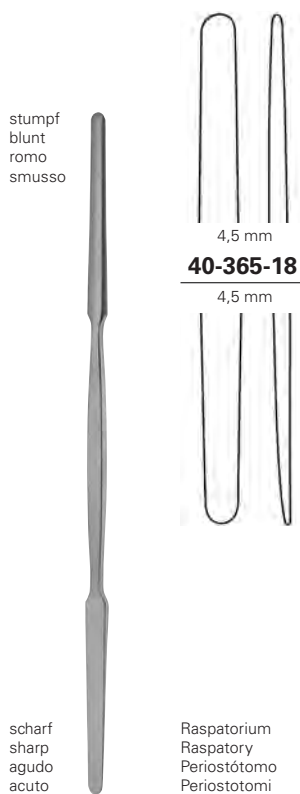
**KILLIAN**

**40-363-22** 22,0 cm, 8 3/4 "



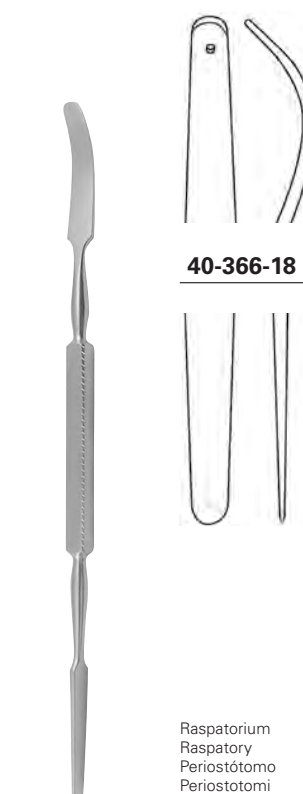
**ADLERDYCE**

**40-364-21** 21,0 cm, 8 1/4 "



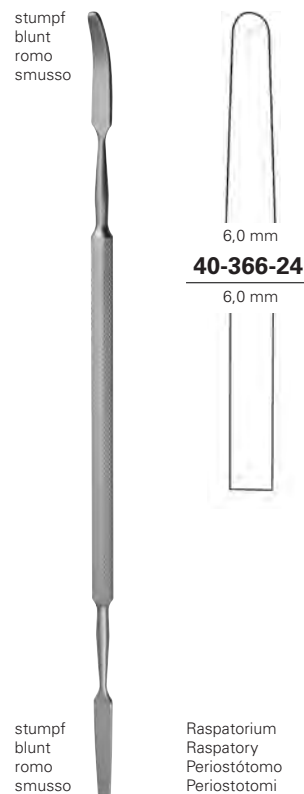
**KILLIAN**

**40-365-18** 18,0 cm, 7 "



**MC DONALD**

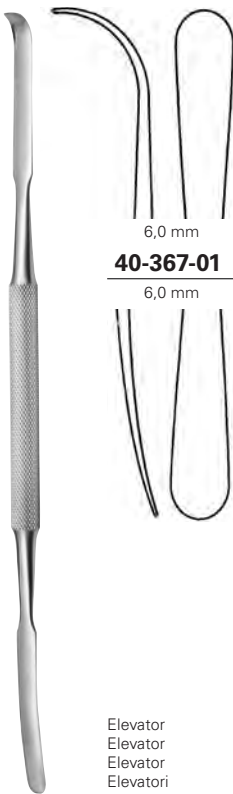
**40-366-18** 18,5 cm, 7 1/4 "



**COHEN**

**40-366-24** 24,0 cm, 9 1/2 "

stumpf  
blunt  
romo  
smusso



**40-367-01**  
6,0 mm

stumpf  
blunt  
romo  
smusso

Elevator  
Elevator  
Elevator  
Elevatori

**OBWEGESER**

**40-367-01** 21,0 cm, 8 ¼"

stumpf  
blunt  
romo  
smusso



**40-367-02**  
6,0 mm

scharf  
sharp  
agudo  
acuto

Elevator  
Elevator  
Elevator  
Elevatori

**OBWEGESER**

**40-367-02** 21,0 cm, 8 ¼"



**40-371-13**  
2,0 mm



Dissektor  
Dissector  
Dissectore  
Dissettori

**WATSON-CHEYNE**

**40-371-13** 13,0 cm, 5 ⅛"



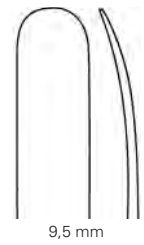
**40-371-19**  
2,0 mm



Dissektor  
Dissector  
Dissectore  
Dissettori

**WATSON-CHEYNE**

**40-371-19** 19,0 cm, 7 ½"



**40-372-17**  
9,5 mm



Dissektor  
Dissector  
Dissectore  
Dissettori

**WATSON-CHEYNE**

**40-372-17** 17,0 cm, 6 ¾"



**40-369-18**

Unterkieferkörperhaken  
 Mandibular body retractor  
 Separador para el cuerpo mandibular  
 Separatore per il corpo mandibulare

**HARGIS**

**40-369-18** 18,0 cm, 7"



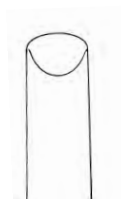
**40-369-19**

Vorderrandstripper  
 Anterior border stripper  
 Separador para el borde anterior  
 Separatore per il borde anteriore



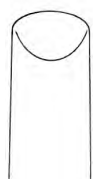
**HARGIS**

**40-369-19** 19,0 cm, 7 1/2"



8,0 mm

**40-373-08**



10,0 mm

**40-373-10**



Progenierinnen Haken  
 Channel retractors  
 Separadores mandibulares  
 Separatori mandibulari

**OBWEGESER**

**40-373-08 - 40-373-10** 16,5 cm, 6 1/2"



Kinnhalter  
 Chin retractor  
 Gancho de mentón  
 Guancio per mento

**OBWEGESER**

**40-373-16** 16,5 cm, 6 1/2"



**40-374-01**

**OBWEGESER**

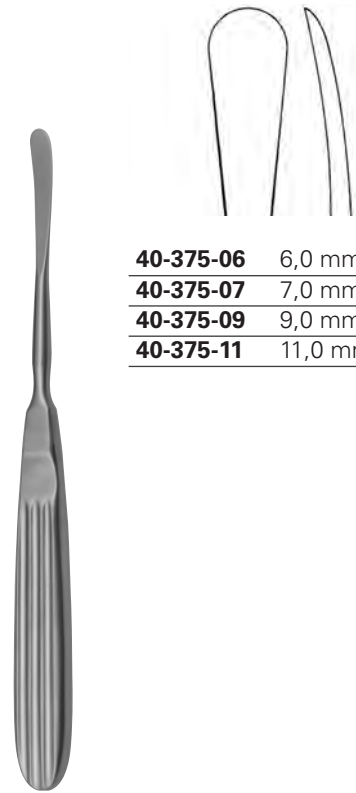
**40-374-01** 17,5 cm, 7 "



**40-374-02**

**OBWEGESER**

**40-374-02** 17,5 cm, 7 "



**40-375-06** 6,0 mm

**40-375-07** 7,0 mm

**40-375-09** 9,0 mm

**40-375-11** 11,0 mm

**OBWEGESER**

**40-375-06 - 40-375-11** 17,5 cm, 7 "



**40-376-01**

**TESSIER**

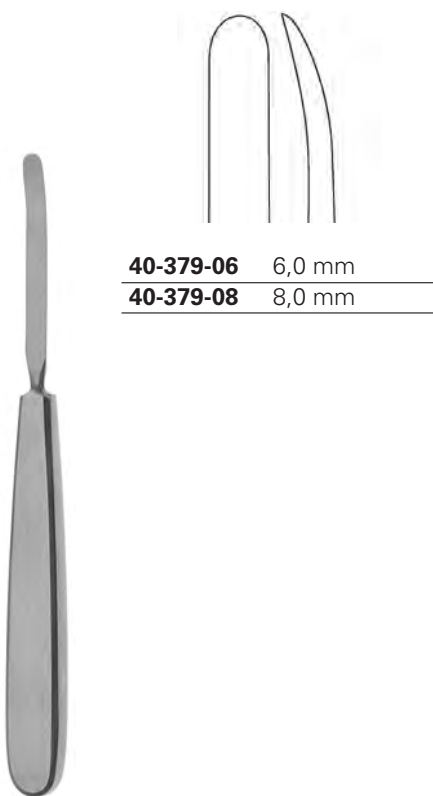
**40-376-01** 18,5 cm, 7 ¼ "



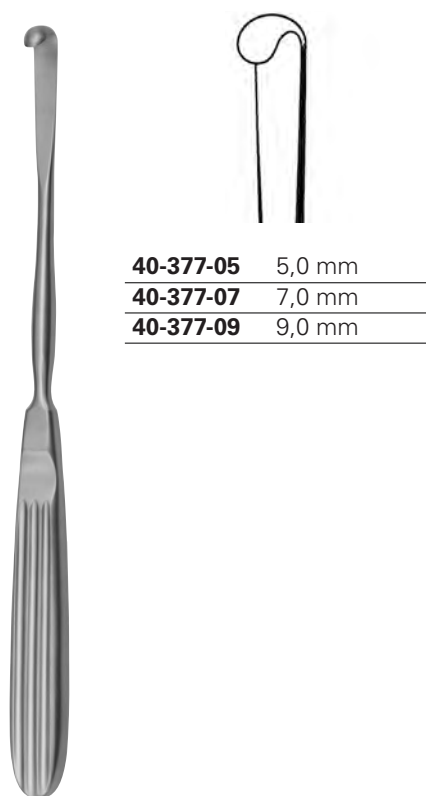
**40-376-02**

**TESSIER**

**40-376-02** 18,5 cm, 7 ¼ "



**40-379-06** 6,0 mm  
**40-379-08** 8,0 mm

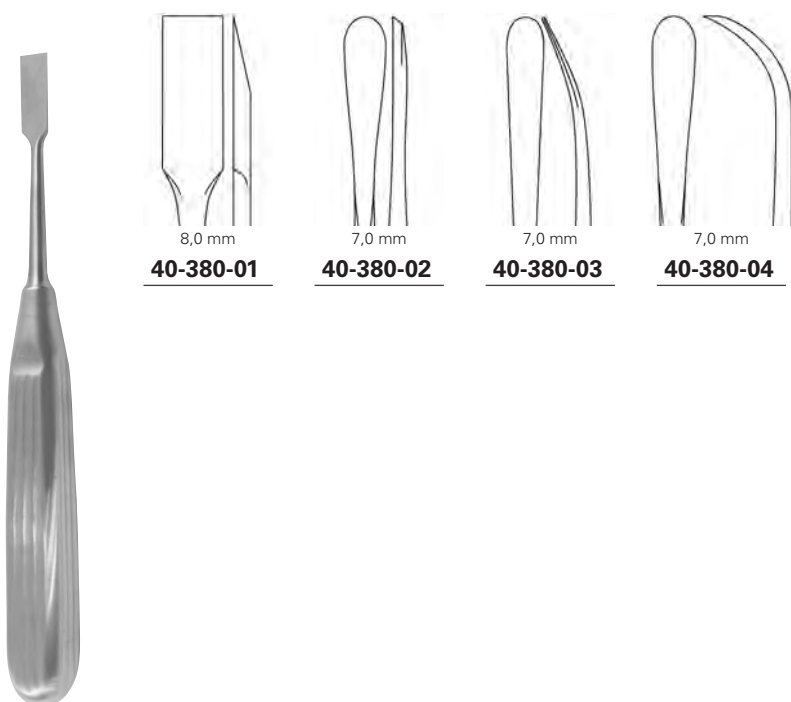


**40-377-05** 5,0 mm  
**40-377-07** 7,0 mm  
**40-377-09** 9,0 mm

**OBWEGESER**

**40-379-06 - 40-379-08** 17,0 cm, 6 3/4 "

**40-377-05 - 40-377-09** 20,5 cm, 8 "



**40-380-01** 8,0 mm  
**40-380-02** 7,0 mm  
**40-380-03** 7,0 mm  
**40-380-04** 7,0 mm

**ADSON**

**40-380-01 - 40-380-04** 17,0 cm, 6 3/4 "



**40-381-19**

**SEWALL**

**40-381-19** 19,0 cm, 7 1/2"



8,0 mm  
**40-382-19**

**COTTLE**

**40-382-19** 19,0 cm, 7 1/2"



9,0 mm  
**40-383-09**

**JANSEN**

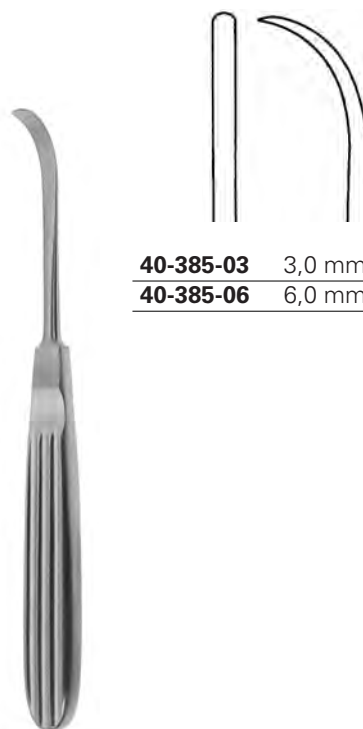
**40-383-09** 19,5 cm, 7 3/4"



14,0 mm  
**40-383-14**

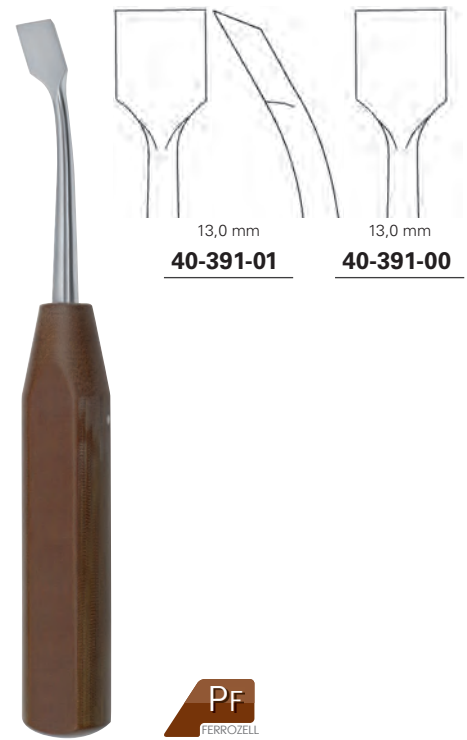
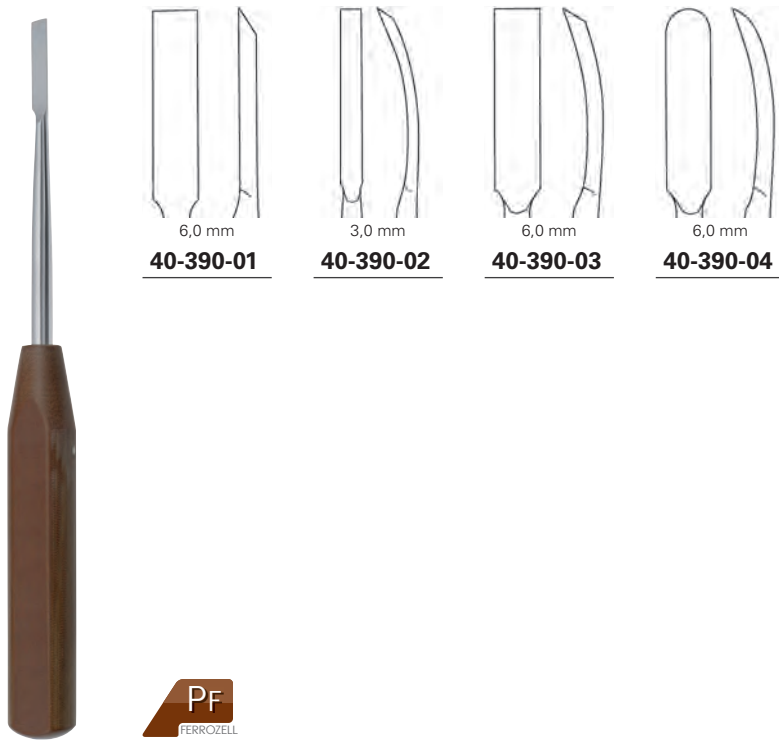
**JANSEN**

**40-383-14** 19,5 cm, 7 3/4"



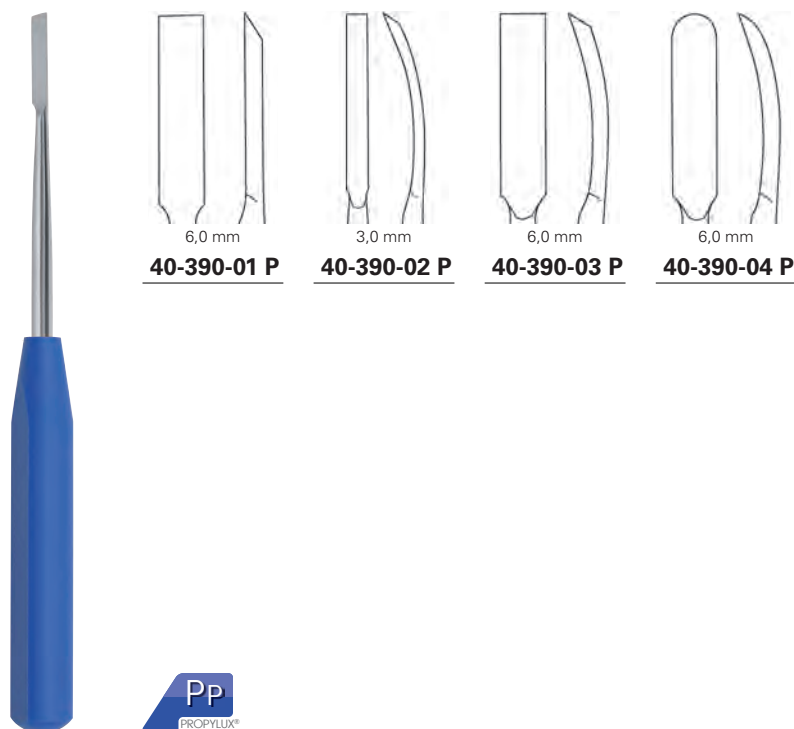
**40-385-03** 3,0 mm  
**40-385-06** 6,0 mm

**40-385-03 - 40-385-06** 17,0 cm, 6 3/4"



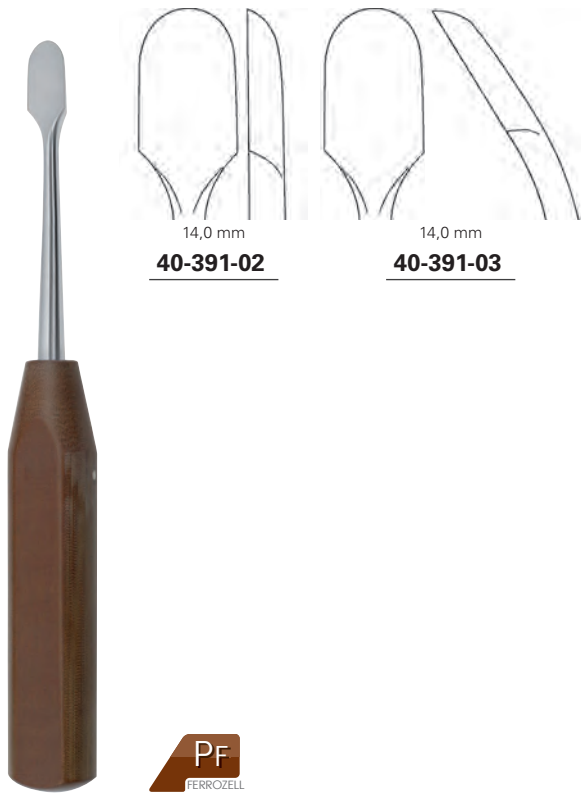
**40-390-01 - 40-390-04** 19,0 cm, 7 ½"

**40-391-00 - 40-391-01** 19,0 cm, 7 ½"



**40-390-01 P - 40-390-04 P** 19,0 cm, 7 ½"

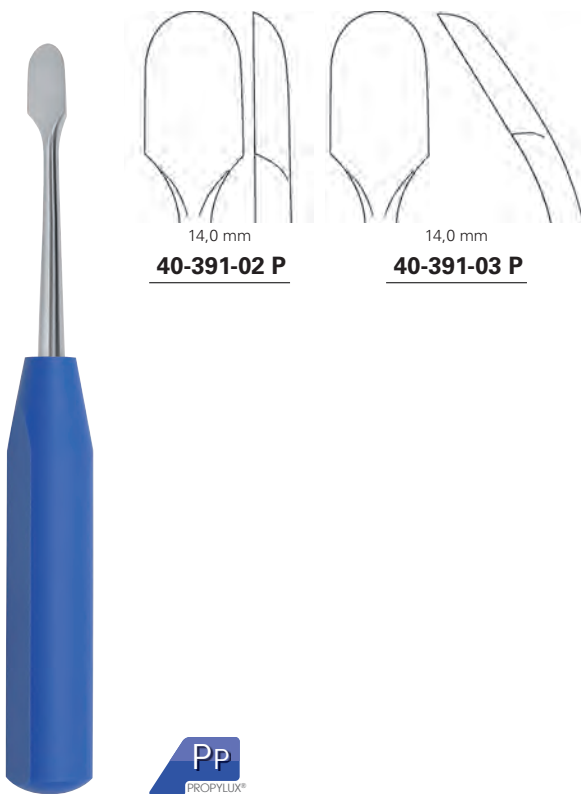
**40-391-00 P - 40-391-01 P** 23,0 cm, 9"



**40-391-02 - 40-391-03** 20,0 cm, 8"



**40-391-04** 20,5 cm, 8"

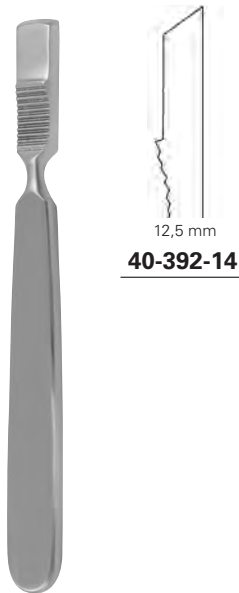


**40-391-02 P - 40-391-03 P** 19,0 cm, 7 1/2"



**40-391-04 P** 20,5 cm, 8"

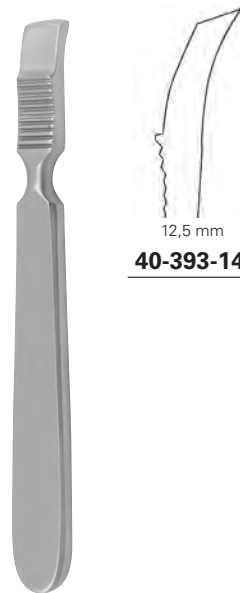




12,5 mm  
**40-392-14**

**FARABEUF**

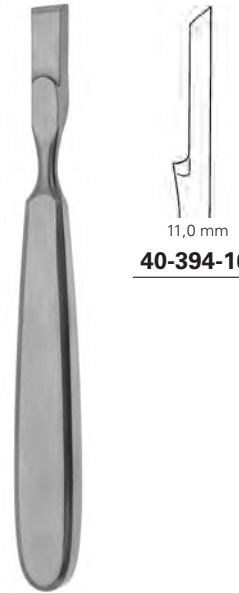
**40-392-14** 15,0 cm, 6"



12,5 mm  
**40-393-14**

**FARABEUF**

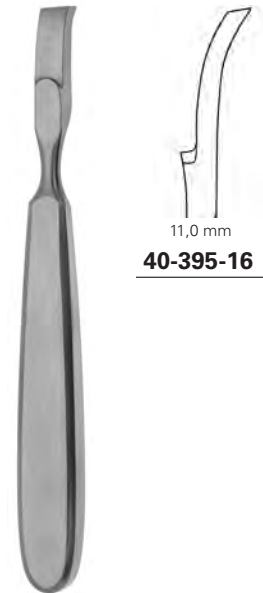
**40-393-14** 15,0 cm, 6"



11,0 mm  
**40-394-16**

**FARABEUF-COLLIN**

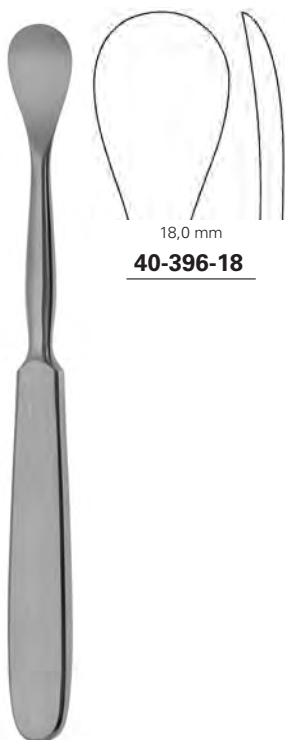
**40-394-16** 16,0 cm, 6 3/4"



11,0 mm  
**40-395-16**

**FARABEUF-COLLIN**

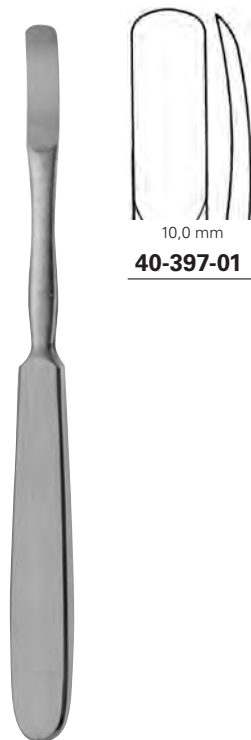
**40-395-16** 16,0 cm, 6 3/4"



18,0 mm  
**40-396-18**

**SEDILLOT**

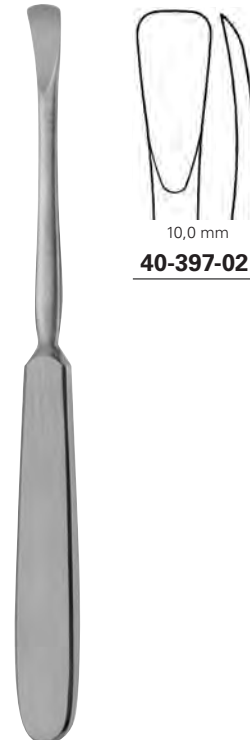
**40-396-18** 18,5 cm, 7 1/4"



10,0 mm  
**40-397-01**

**KRAEMER**

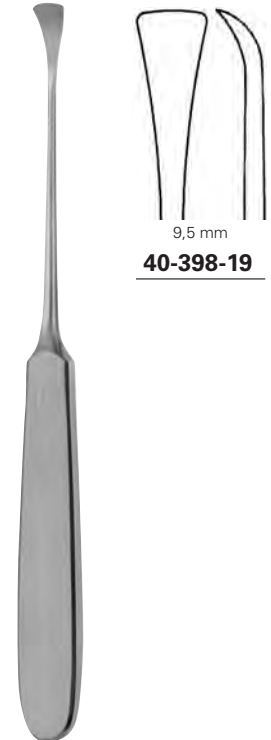
**40-397-01** 18,5 cm, 7 1/4"



10,0 mm  
**40-397-02**

**KRAEMER**

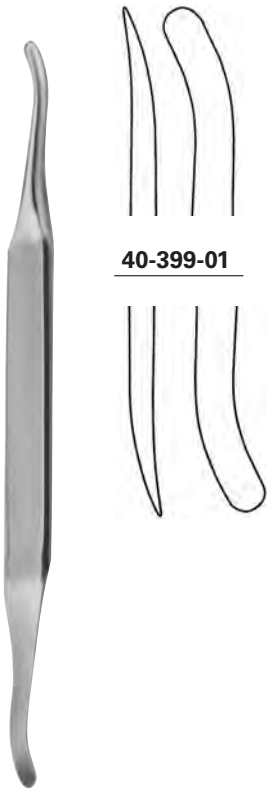
**40-397-02** 19,0 cm, 7 1/2"



9,5 mm  
**40-398-19**

**BUECHS**

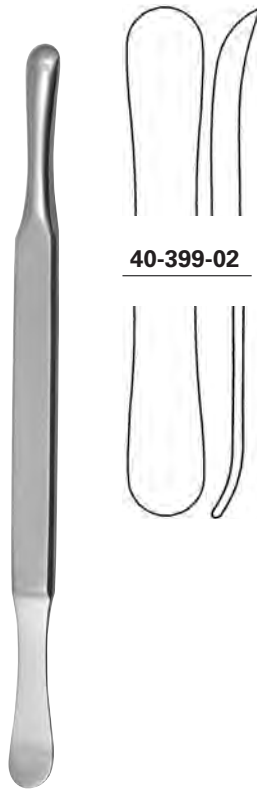
**40-398-19** 19,0 cm, 7 1/2"



**40-399-01**

**SELDIN**

**40-399-01** 19,5 cm, 7 3/4"



**40-399-02**

**SELDIN**

**40-399-02** 19,5 cm, 7 3/4"



15,0 mm  
**40-400-16**

**JANSEN**

**40-400-16** 16,5 cm, 6 1/2"



14,0 mm  
**40-401-01**

**LANGENBECK**

**40-401-01** 18,0 cm, 7"



16,0 mm  
**40-401-02**

**LANGENBECK**

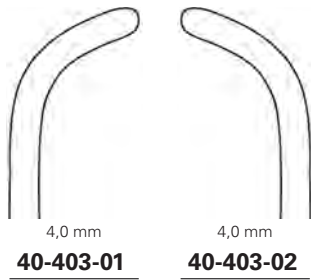
**40-401-02** 19,0 cm, 7 1/2"



13,0 mm  
**40-402-01**

**SCHNEIDER**

**40-402-01** 17,5 cm, 7"



**40-403-01**

**40-403-02**

**40-403-01 - 40-403-02** 14,0 cm, 5 ½"



**40-405-05** 5,0 mm

**40-405-10** 10,0 mm

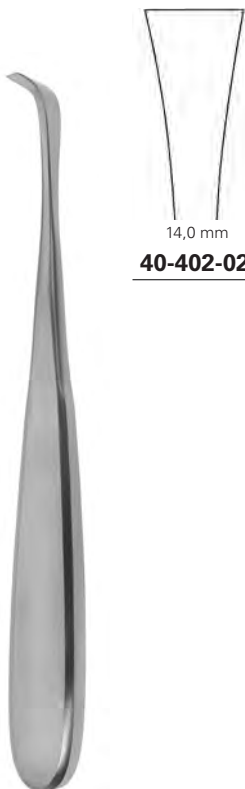
**40-405-15** 15,0 mm

**40-405-20** 20,0 mm

**40-405-25** 25,0 mm

### LAMBOTTE

**40-405-05 - 40-405-25** 21,0 cm, 8 ¼"



**40-402-02**

### SCHNEIDER-SAUERBRUCH

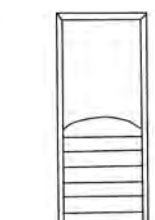
**40-402-02** 19,0 cm, 7 ½"



**40-404-21**

### SEDILLOT

**40-404-21** 21,0 cm, 8 ¼"



**40-406-21**

### ALEXANDER

**40-406-21** 21,0 cm, 8 ¼"



**SEMB**

**40-408-01 - 40-408-03** 19,0 cm, 7 1/2"

**40-408-02 - 40-408-04** 22,0 cm, 8 3/4"

**40-408-05 - 40-408-07** 23,0 cm, 9"



**40-409-01**

für Kinder, links  
for children, left  
para niños, izquierda  
per bambini, sinistra

**DOYEN**

**40-409-01** 17,0 cm, 6 3/4"



**40-409-02**

für Kinder, rechts  
for children, right  
para niños, derecha  
per bambini, destra

**DOYEN**

**40-409-02** 17,0 cm, 6 3/4"



**40-410-01**

für Erwachsene, links  
for adults, left  
para adultos, izquierda  
per adultii, sinistra

**DOYEN**

**40-410-01** 17,0 cm, 6  $\frac{3}{4}$ ''



**40-410-02**

für Erwachsene, rechts  
for adults, right  
para adultos, derecha  
per adultii, destra

**DOYEN**

**40-410-02** 17,0 cm, 6  $\frac{3}{4}$ ''



**40-411-01**

für Erwachsene, links  
for adults, left  
para adultos, izquierda  
per adultii, sinistra

**DOYEN**

**40-411-01** 24,0 cm, 9  $\frac{1}{2}$ ''



**40-411-02**

für Erwachsene, rechts  
for adults, right  
para adultos, derecha  
per adultii, destra

**DOYEN**

**40-411-02** 24,0 cm, 9  $\frac{1}{2}$ ''



<b>40-412-09</b>	9,0 mm
<b>40-412-11</b>	11,0 mm
<b>40-412-13</b>	13,0 mm
<b>40-412-15</b>	15,0 mm
<b>40-412-17</b>	17,0 mm

**MC GLAMRY**

**40-412-09 - 40-412-17** 17,0 cm, 6 3/4"



7,0 mm  
**40-413-16**



**HOEN**

**40-413-16** 16,0 cm, 6 1/4"



<b>40-413-18</b>	15,0 mm
<b>40-413-19</b>	20,0 mm



**HOEN**

**40-413-18 - 40-413-19** 19,0 cm, 7 1/2"



6,0 mm  
**40-414-06**

10,0 mm  
**40-414-10**

13,0 mm  
**40-414-13**

19,0 mm  
**40-414-19**

25,0 mm  
**40-414-25**

**KEY**

<b>40-414-06</b>	18,0 cm, 7"
<b>40-414-10 - 40-414-13</b>	19,0 cm, 7 1/2"
<b>40-414-19</b>	20,0 cm, 8"
<b>40-414-25</b>	21,0 cm, 8 1/4"



20,0 mm  
**40-415-27**

**PF**  
FERROZELL

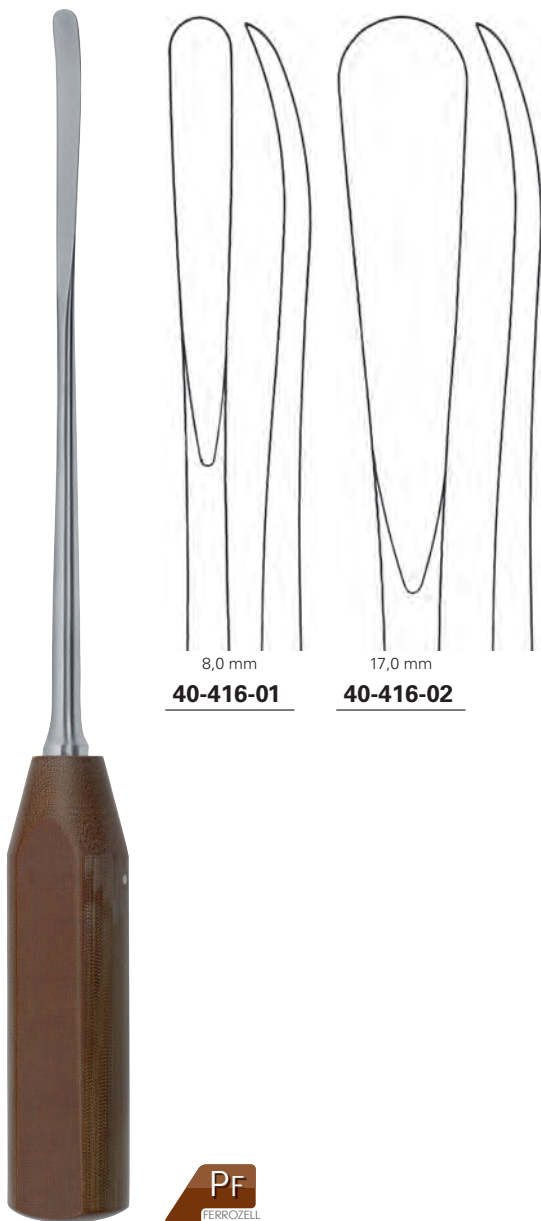
**40-415-27** 27,0 cm, 10 <sup>3</sup>/<sub>4</sub> "



20,0 mm  
**40-415-27 P**

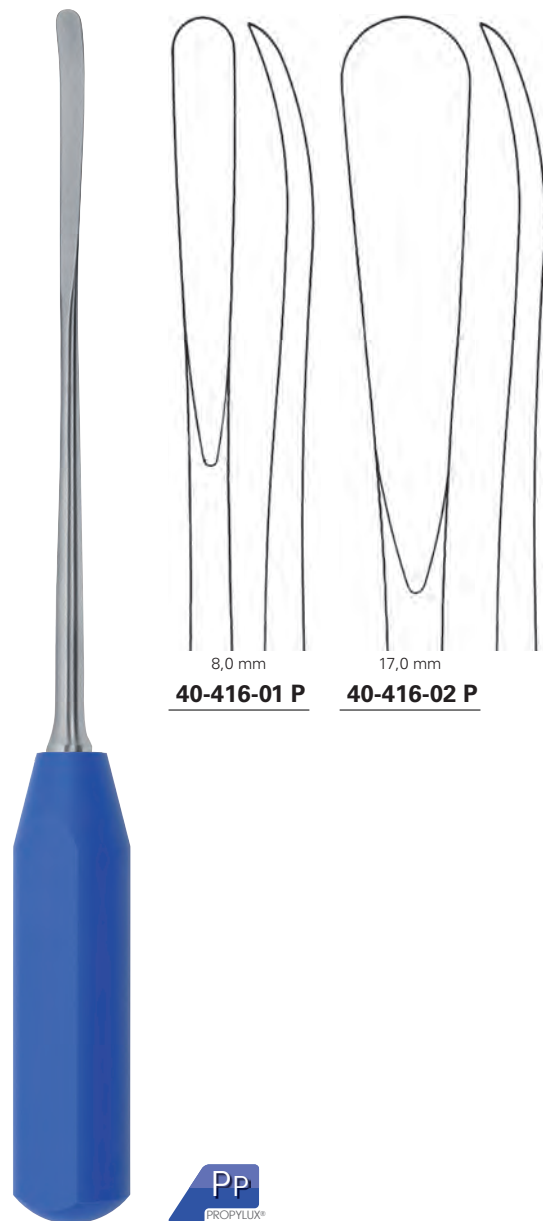
**PP**  
PROPYLUX®

**40-415-27 P** 27,0 cm, 10 <sup>3</sup>/<sub>4</sub> "



**WAGNER**

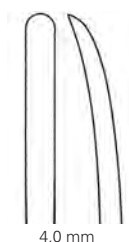
**40-416-01 - 40-416-02** 33,0 cm, 13"



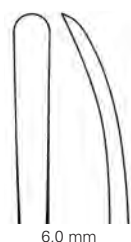
**WAGNER**

**40-416-01 P - 40-416-02 P** 33,0 cm, 13"

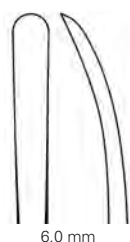




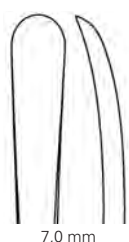
4,0 mm  
**40-417-01**



6,0 mm  
**40-417-02**



6,0 mm  
**40-417-03**



7,0 mm  
**40-417-04**



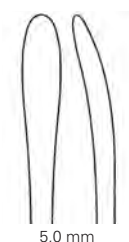
8,0 mm  
**40-417-05**

### MARTIN-CUSHING

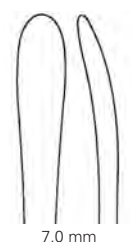
**40-417-01 - 40-417-02** 17,0 cm, 6 <sup>3</sup>/<sub>4</sub> "  
**40-417-03 - 40-417-04** 19,5 cm, 7 <sup>3</sup>/<sub>4</sub> "

### MARTIN-CUSHING

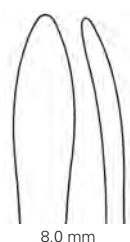
**40-417-05** 17,0 cm, 6 <sup>3</sup>/<sub>4</sub> "



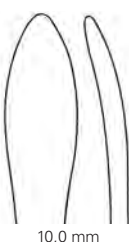
5,0 mm  
**40-420-05**



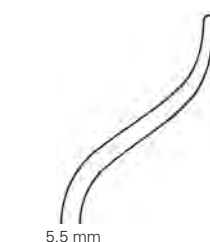
7,0 mm  
**40-420-07**



8,0 mm  
**40-420-08**



10,0 mm  
**40-420-10**



5,5 mm  
**40-421-16**

### MARTIN-LANGENBECK

**40-420-05 - 40-420-08** 17,0 cm, 6 <sup>3</sup>/<sub>4</sub> "  
**40-420-10** 19,5 cm, 7 <sup>3</sup>/<sub>4</sub> "

**40-421-16** 16,0 cm, 6 <sup>1</sup>/<sub>4</sub> "



Fig. 1 | 10,0 mm  
**40-418-01**



Fig. 2 | 13,0 mm  
**40-418-02**



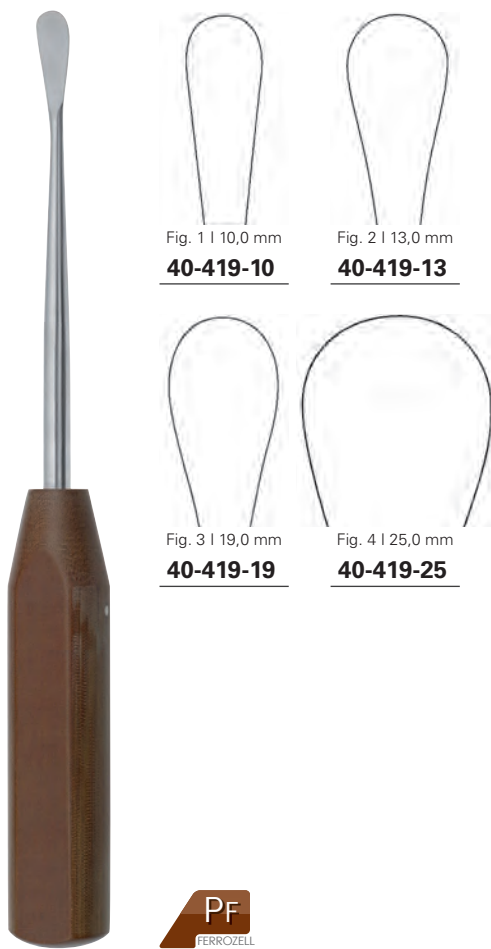
Fig. 3 | 19,0 mm  
**40-418-03**



Fig. 4 | 25,0 mm  
**40-418-04**

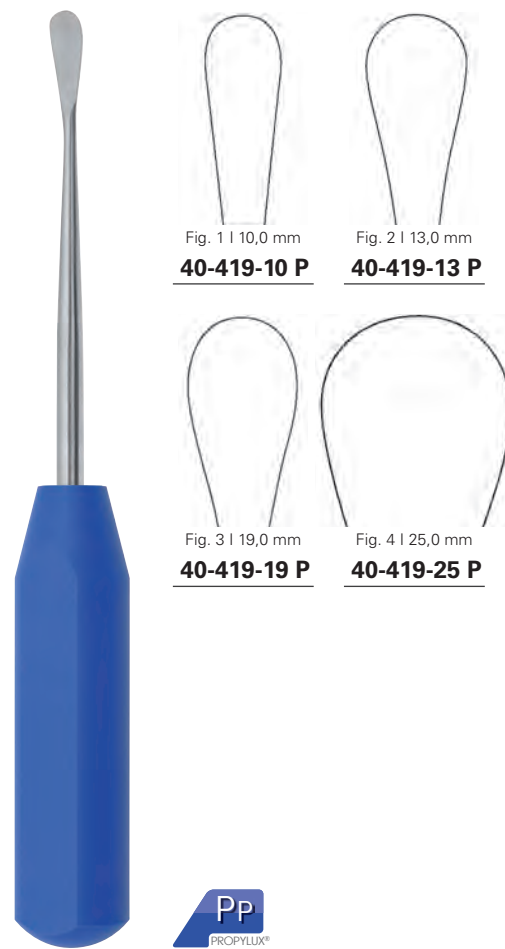
**COBB**

**40-418-01 - 40-418-04** 28,0 cm, 11 "



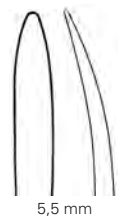
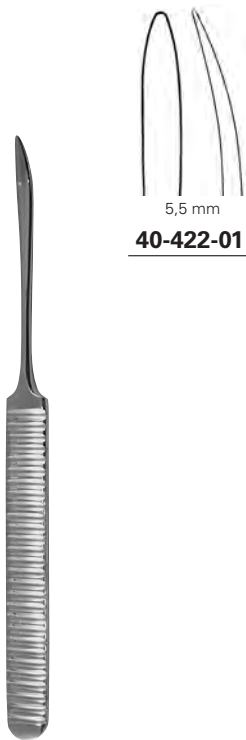
**COBB**

**40-419-10 - 40-419-25** 25,0 cm, 10"

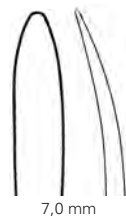


**COBB**

**40-419-10 P - 40-419-25 P** 25,0 cm, 10"



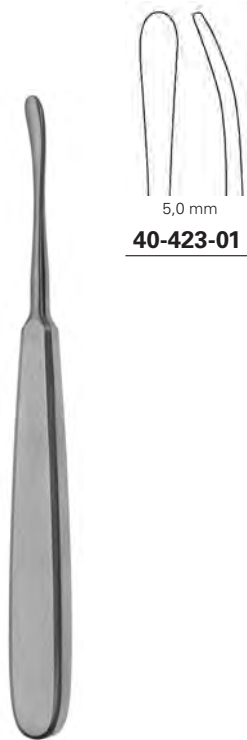
**40-422-01**



**40-422-02**

**WILLIGER**

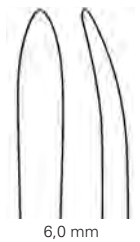
**40-422-01** 16,0 cm, 6 1/4 "  
**40-422-02** 17,0 cm, 6 3/4 "



**40-423-01**

**SEBILEAU**

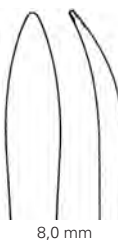
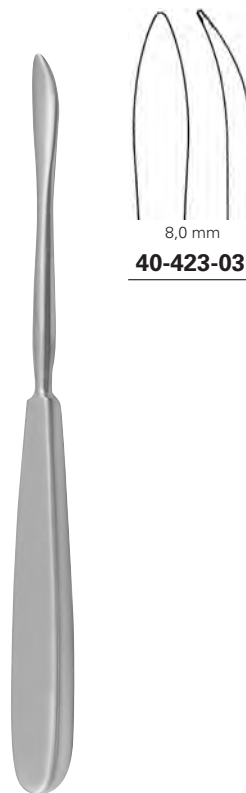
**40-423-01** 17,0 cm, 6 3/4 "



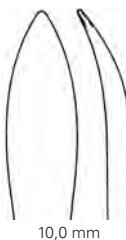
**40-423-02**

**QUERVAIN**

**40-423-02** 19,5 cm, 7 3/4 "



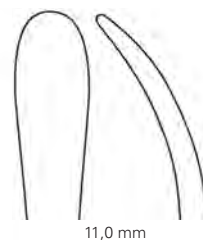
**40-423-03**



**40-423-04**

**LANGENBECK**

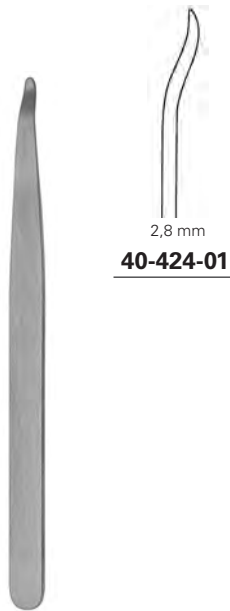
**40-423-03 - 40-423-04** 19,5 cm, 7 3/4 "



**40-423-05**

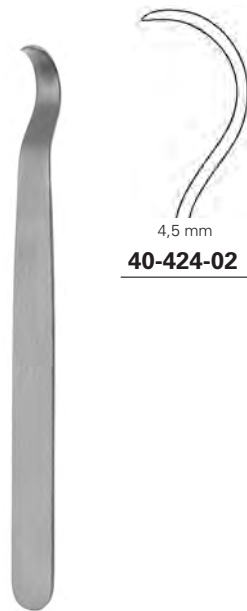
**LANGENBECK**

**40-423-05** 23,0 cm, 9 "



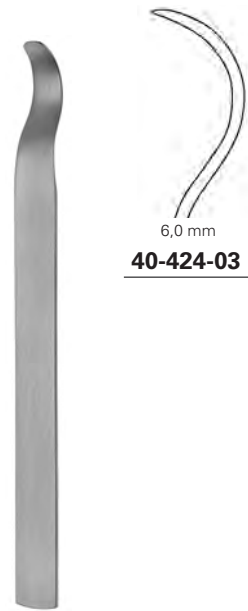
**40-424-01**

**40-424-01** 14,0 cm, 5 1/2 "



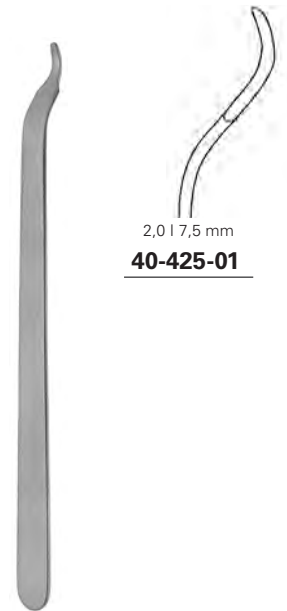
**40-424-02**

**40-424-02** 15,0 cm, 6 "



**40-424-03**

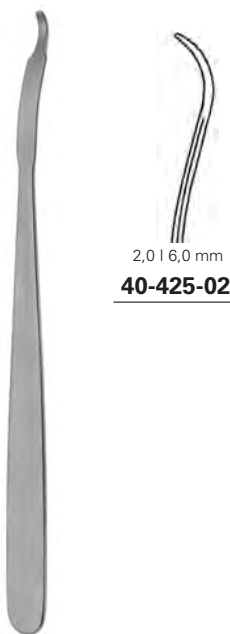
**40-424-03** 15,0 cm, 6 "



**40-425-01**

**BUCK-GRAMCKO**

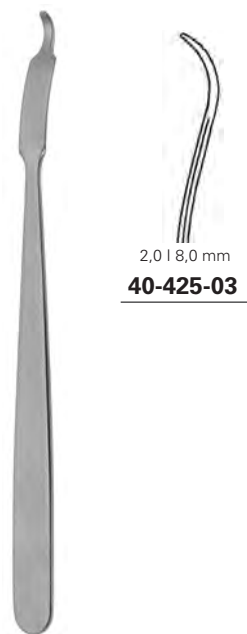
**40-425-01** 15,0 cm, 6 "



**40-425-02**

**MINI-HOHMANN**

**40-425-02** 16,0 cm, 6 1/4 "



**40-425-03**

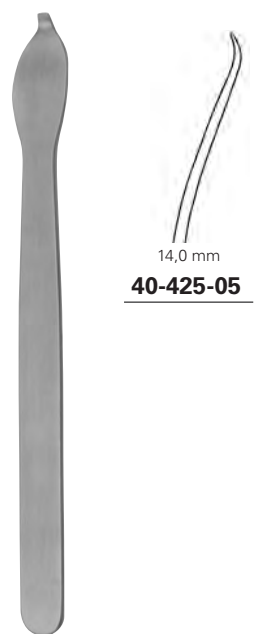
**MINI-HOHMANN**

**40-425-03** 16,0 cm, 6 1/4 "



**40-425-04**

**40-425-04** 12,0 cm, 4 3/4 "



**40-425-05**

**40-425-05** 16,0 cm, 6 1/4 "



**LANE-TRETHOWAN**

**40-426-21** 21,5 cm, 8 ½"



**LANE**

**40-426-26** 25,5 cm, 10"

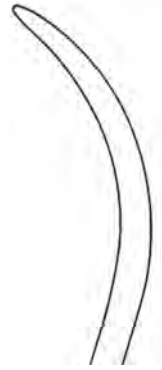


**WATSON-JONES**

**40-426-28** 28,0 cm, 11"



**40-426-28**



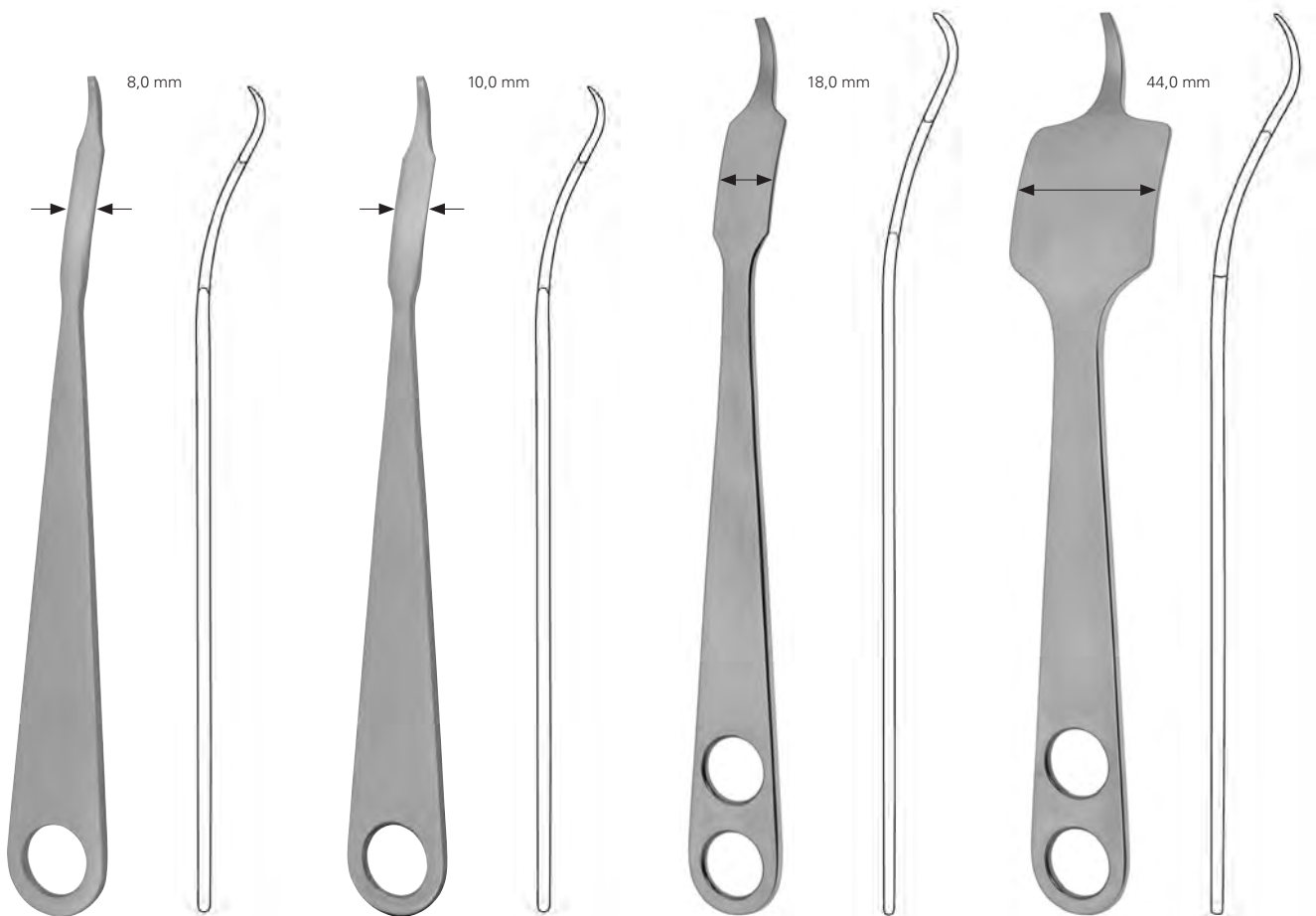
**40-427-33**



**WAGNER**

**40-427-33** 33,0 cm, 13"





**HOHMANN**

**40-428-00** 22,0 cm, 8 <sup>3</sup>/<sub>4</sub> "

**HOHMANN**

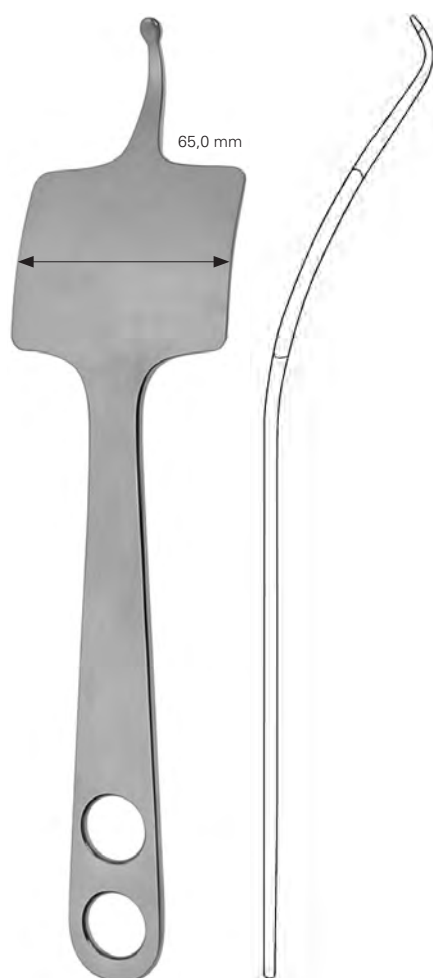
**40-428-01** 22,0 cm, 8 <sup>3</sup>/<sub>4</sub> "

**HOHMANN**

**40-428-02** 24,0 cm, 9 <sup>1</sup>/<sub>2</sub> "

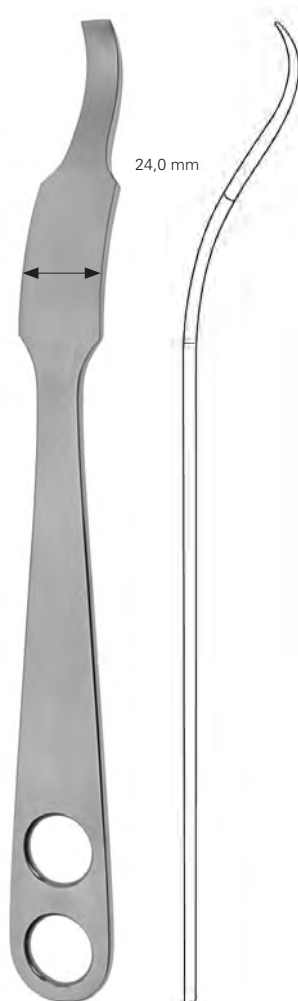
**HOHMANN**

**40-428-03** 24,0 cm, 9 <sup>1</sup>/<sub>2</sub> "



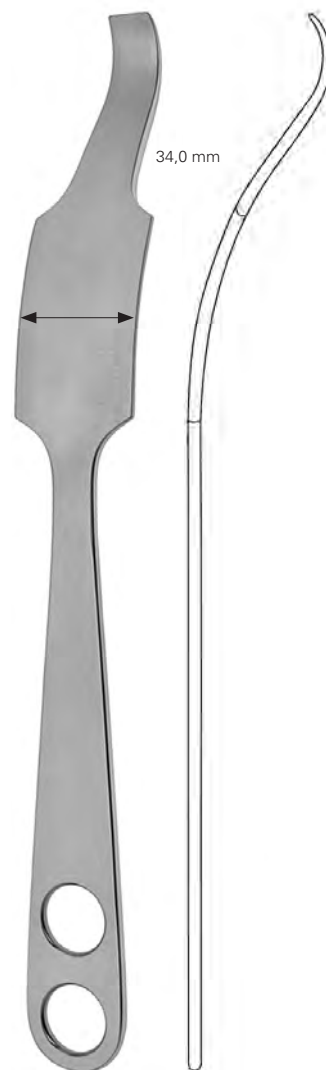
**HOHMANN**

**40-428-04** 25,5 cm, 10 "



**HOHMANN**

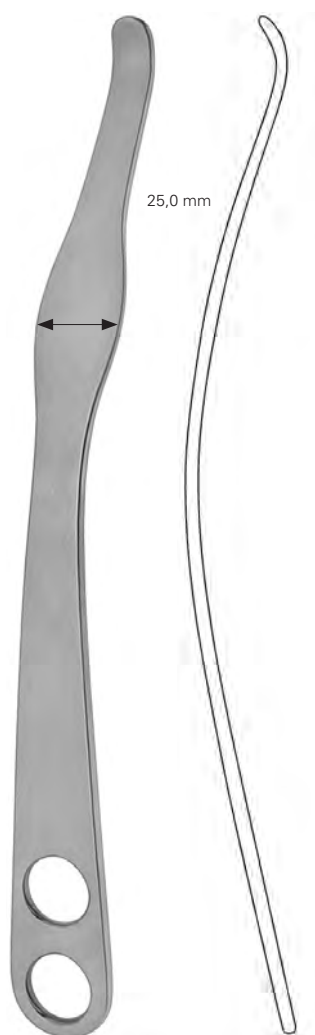
**40-428-06** 26,0 cm, 10 ¼ "



**HOHMANN**

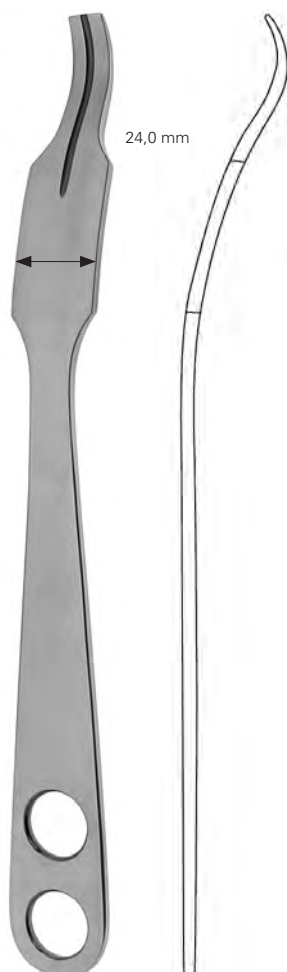
**40-428-07** 28,5 cm, 11 ¼ "





**HOHMANN**

**40-428-08** 27,0 cm, 10 <sup>3</sup>/<sub>4</sub>''



**LANGE-HOHMANN**

**40-428-09** 25,0 cm, 10''



**HOHMANN**

**40-428-10** 23,5 cm, 9 <sup>1</sup>/<sub>4</sub>''



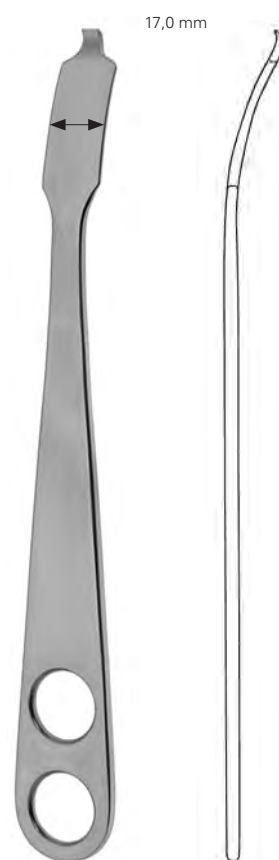
**LANGE-HOHMANN**

**40-429-01** 26,5 cm, 10 1/2"



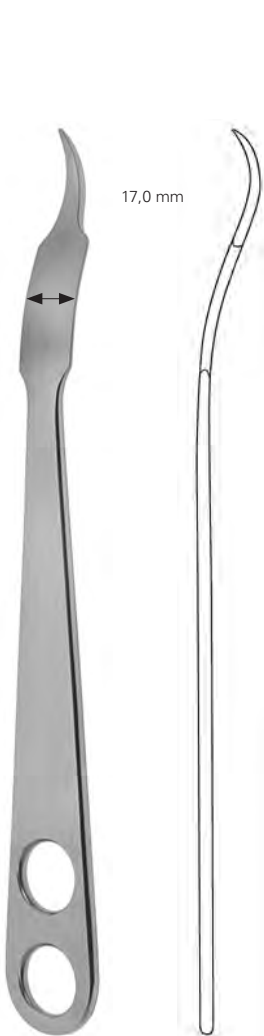
**LANGE-HOHMANN**

**40-429-02** 28,0 cm, 11"



**WAGNER**

**40-430-01** 22,0 cm, 8 3/4"

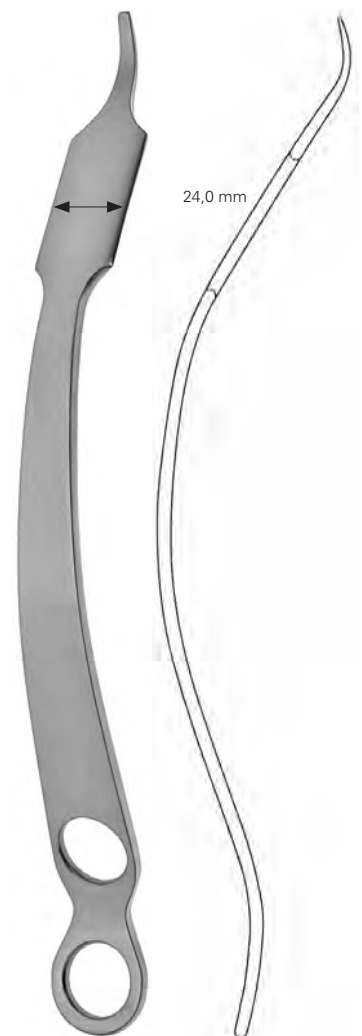


**WAGNER**

**40-430-02** 24,0 cm, 9 1/2"

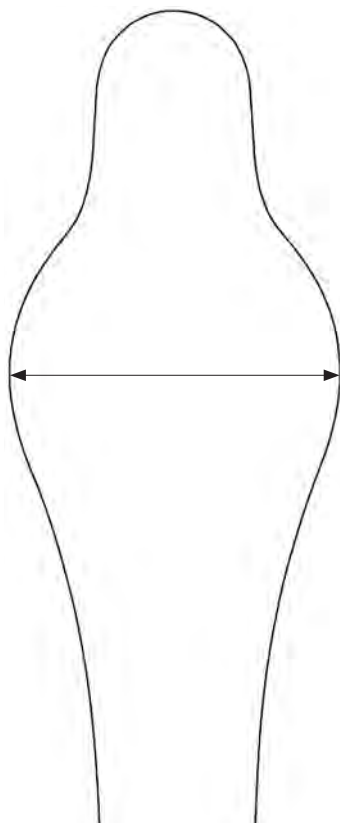


**40-430-03** 27,0 cm, 10 3/4"

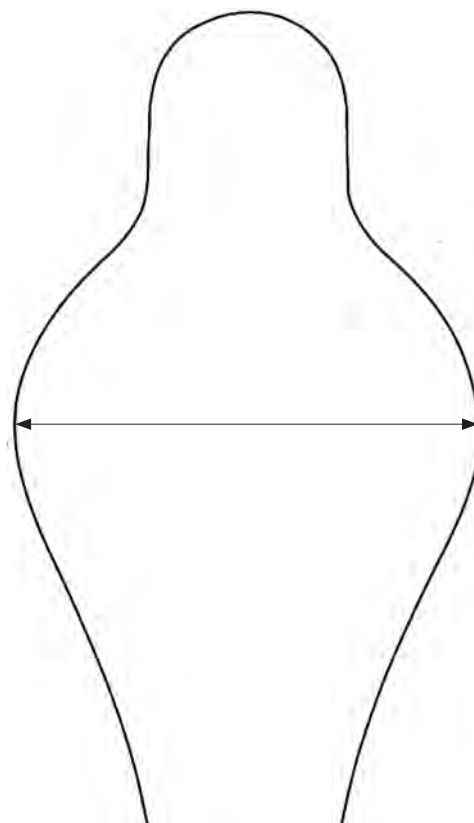


**ALDINGER**

**40-431-27** 27,0 cm, 10 3/4"



25,0 | 43,0 mm  
**40-434-23**



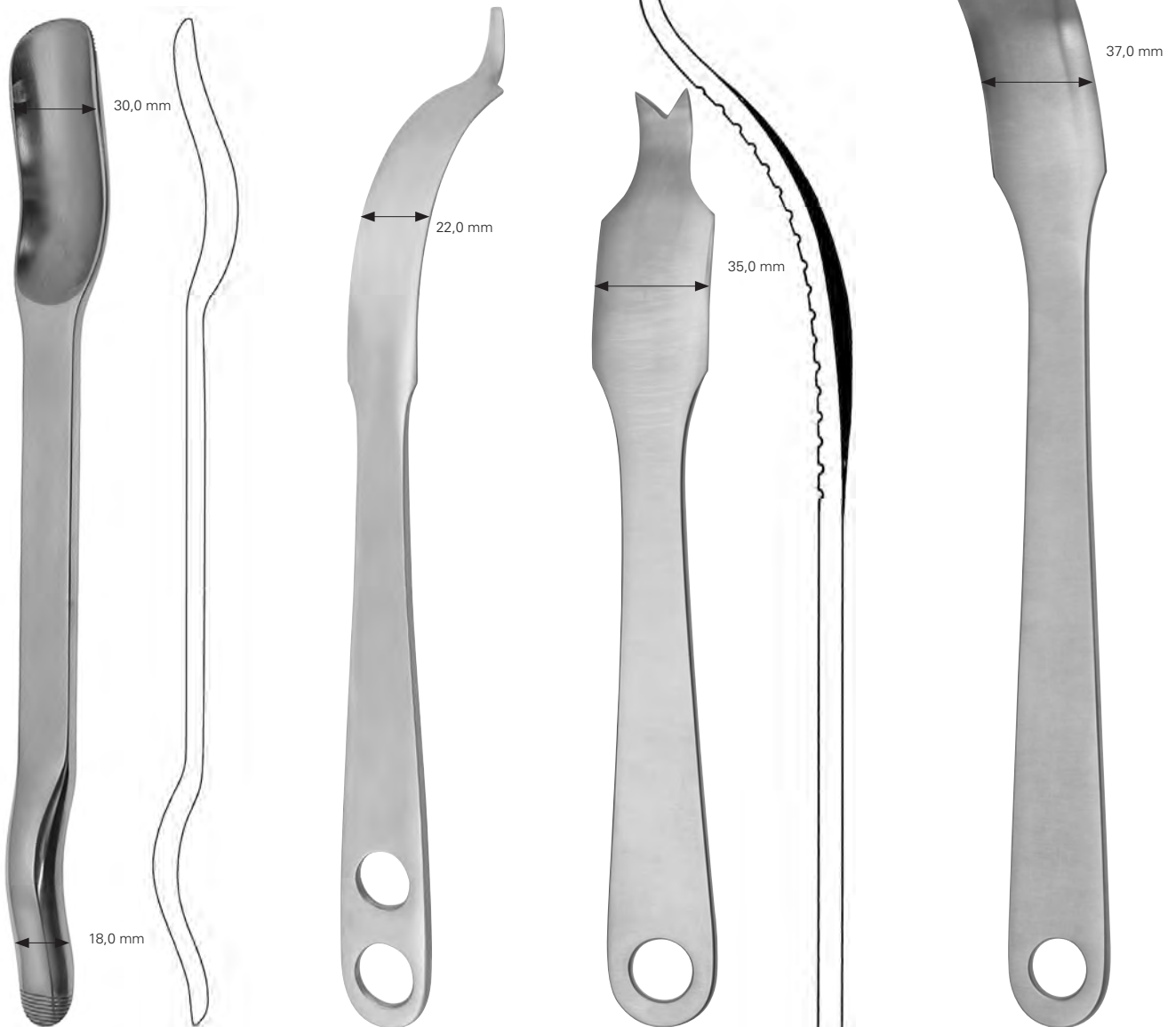
25,0 | 63,0 mm  
**40-434-24**

**BENNET**

**40-434-23 - 40-434-24** 24,0 cm, 9 ½"



Luxationsheber  
 Luxation lever  
 Elevador para luxación  
 Leva per lussazione



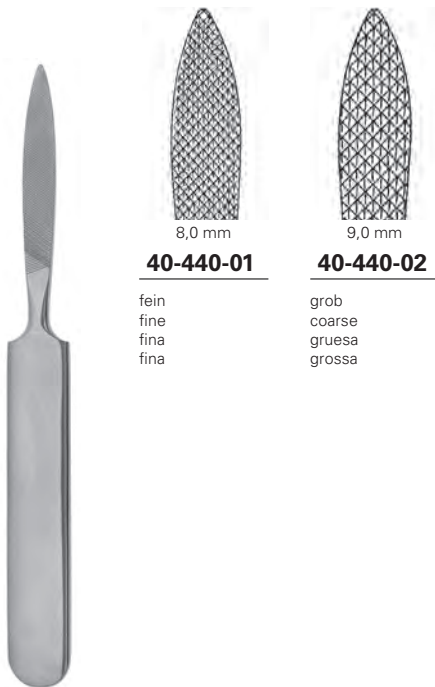
### MURPHY-LANE

**40-435-34** 30,0 cm, 13 1/8"

**40-436-24** 30,0 cm, 13 1/8"

**40-437-28** 28,0 cm, 11"

**40-437-35** 35,0 cm, 13 3/4"



**40-440-01**

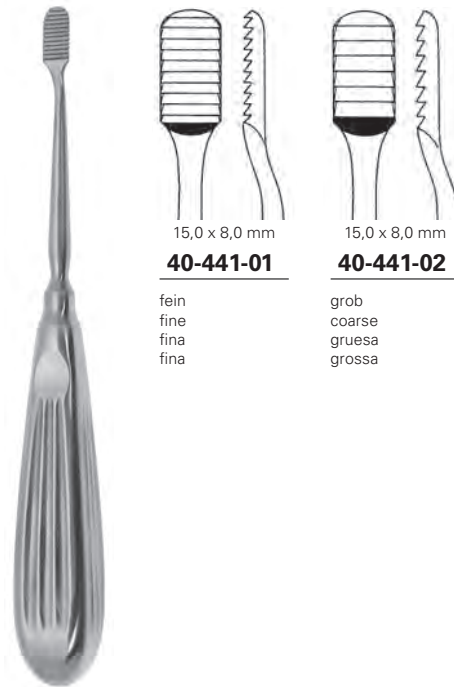
fein  
fine  
fina  
fina

**40-440-02**

grob  
coarse  
gruesa  
grossa

**JOSEPH**

**40-440-01 - 40-440-02** 16,5 cm, 6 ½"



**40-441-01**

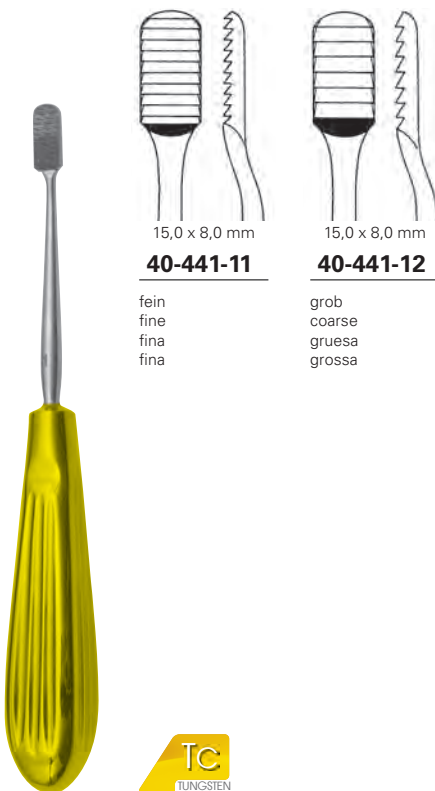
fein  
fine  
fina  
fina

**40-441-02**

grob  
coarse  
gruesa  
grossa

**LEWIS**

**40-441-01 - 40-441-02** 18,0 cm, 7"



**40-441-11**

fein  
fine  
fina  
fina

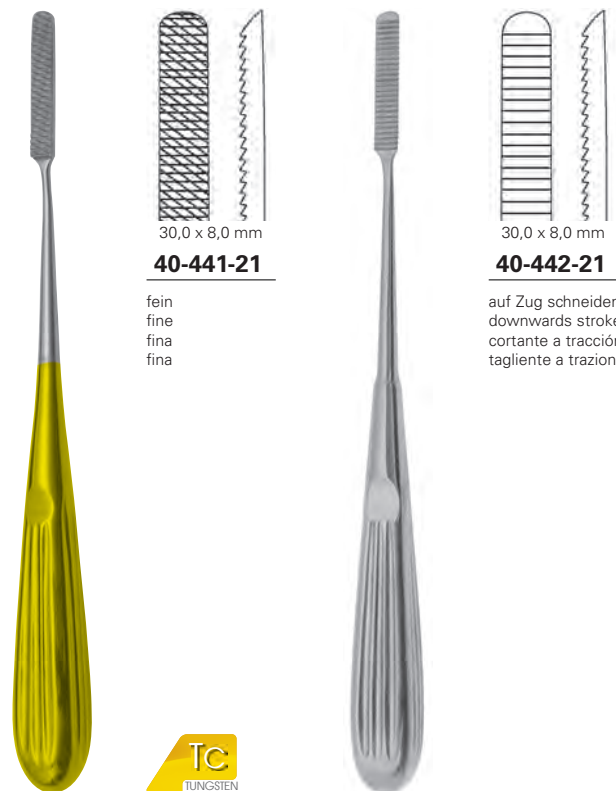
**40-441-12**

grob  
coarse  
gruesa  
grossa



**LEWIS**

**40-441-11 - 40-441-12** 18,0 cm, 7"



**40-441-21**

fein  
fine  
fina  
fina

**40-442-21**

auf Zug schneidend  
downwards stroke  
cortante a tracción  
tagliante a trazione

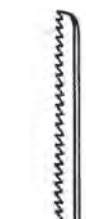


**COTTLE**

**40-441-21** 21,0 cm, 8 ¼"

**COTTLE**

**40-442-21** 21,0 cm, 8 ¼"



**40-442-01**

auf Druck schneidend  
upwards stroke  
cortante a empuje  
tagliante a urto



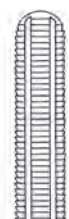
**40-442-02**

auf Zug schneidend  
downwards stroke  
cortante a tracción  
tagliante a trazione



## MALTZ

**40-442-01 - 40-442-02** 17,5 cm, 7"



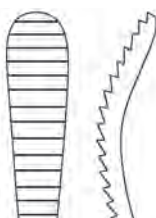
40,0 x 9,0 mm

**40-442-18**

auf Zug schneidend  
downwards stroke  
cortante a tracción  
tagliante a trazione

## MALTZ

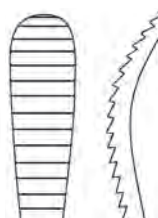
**40-442-18** 18,0 cm, 7"



32,0 x 9,0 mm

**40-443-01**

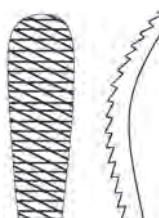
auf Druck schneidend  
upwards stroke  
cortante a empuje  
tagliante a urto



32,0 x 9,0 mm

**40-443-02**

auf Zug schneidend  
downwards stroke  
cortante a tracción  
tagliante a trazione



32,0 x 9,0 mm

**40-443-03**

auf Druck schneidend  
upwards stroke  
cortante a empuje  
tagliante a urto

auf Zug schneidend  
downwards stroke  
cortante a tracción  
tagliante a trazione



45,0 x 6,0 mm

**40-444-01**



45,0 x 6,0 mm

**40-444-02**



45,0 x 6,0 mm

**40-444-03**

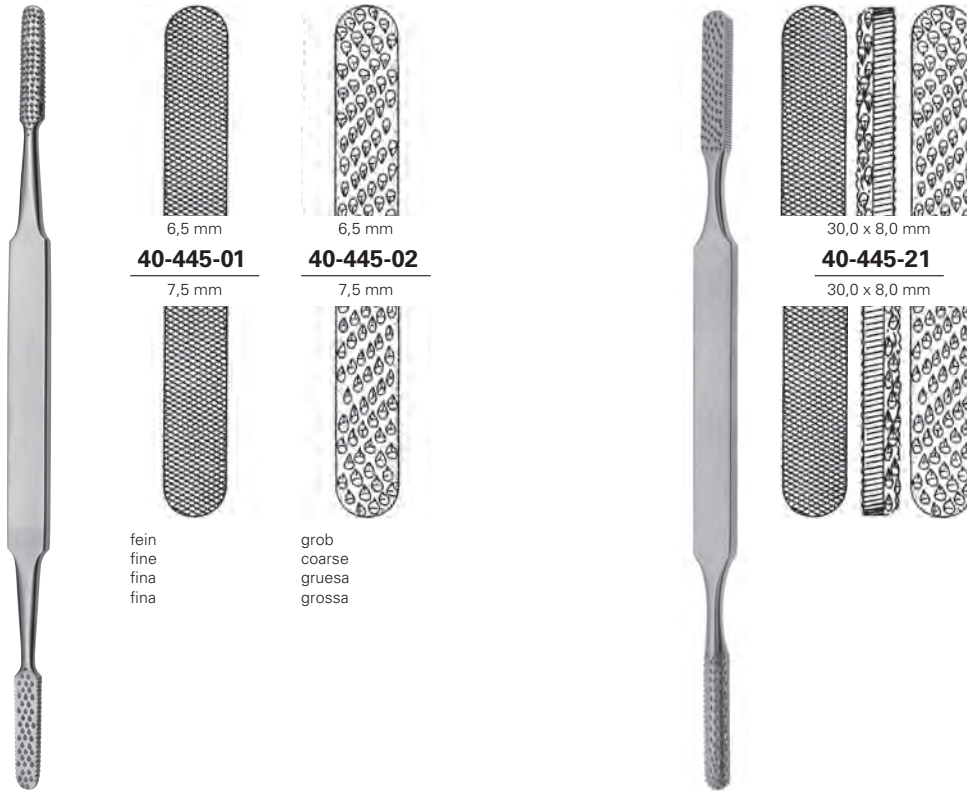


## AUFRICHT

**40-443-01 - 40-443-03** 21,0 cm, 8 1/4"

## GALLAHER

**40-444-01 - 40-444-03** 17,0 cm, 6 3/4"



**40-445-01**  
6,5 mm  
7,5 mm

**40-445-02**  
6,5 mm  
7,5 mm

**40-445-21**  
30,0 x 8,0 mm  
30,0 x 8,0 mm

fein  
fine  
fina  
fina

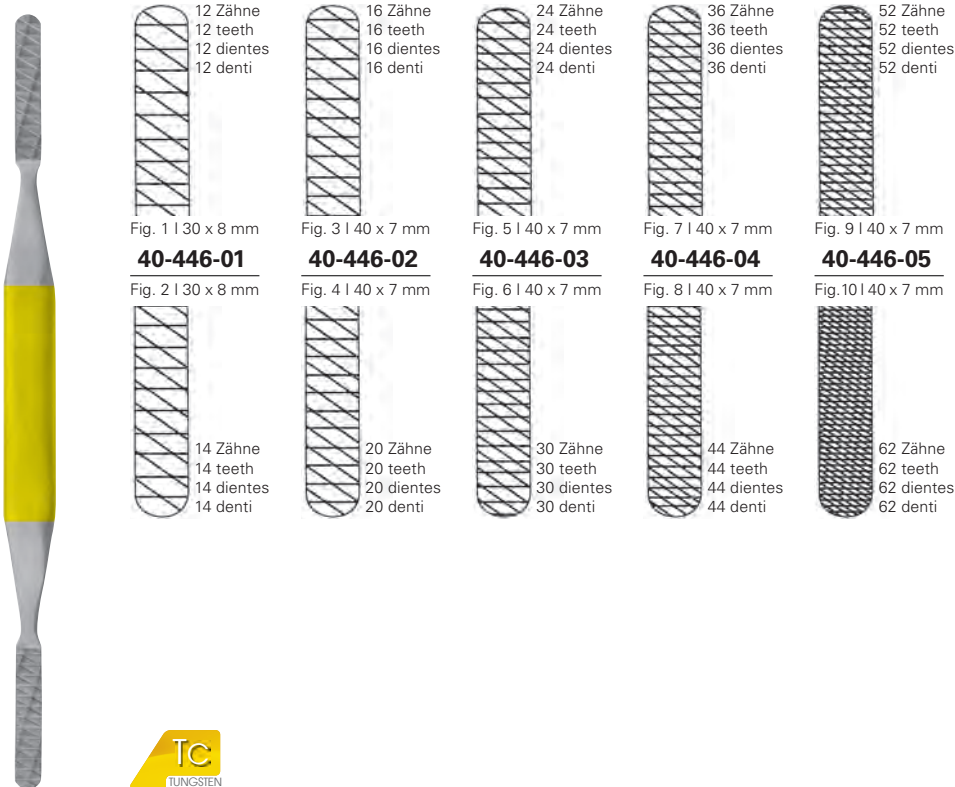
grob  
coarse  
gruesa  
grossa

**FOMON**

**40-445-01 - 40-445-02** 21,0 cm, 8 ¼"

**FOMON**

**40-445-21** 21,0 cm, 8 ¼"



12 Zähne  
12 teeth  
12 dientes  
12 denti  
Fig. 1 | 30 x 8 mm  
**40-446-01**  
Fig. 2 | 30 x 8 mm

16 Zähne  
16 teeth  
16 dientes  
16 denti  
Fig. 3 | 40 x 7 mm  
**40-446-02**  
Fig. 4 | 40 x 7 mm

24 Zähne  
24 teeth  
24 dientes  
24 denti  
Fig. 5 | 40 x 7 mm  
**40-446-03**  
Fig. 6 | 40 x 7 mm

36 Zähne  
36 teeth  
36 dientes  
36 denti  
Fig. 7 | 40 x 7 mm  
**40-446-04**  
Fig. 8 | 40 x 7 mm

52 Zähne  
52 teeth  
52 dientes  
52 denti  
Fig. 9 | 40 x 7 mm  
**40-446-05**  
Fig. 10 | 40 x 7 mm

14 Zähne  
14 teeth  
14 dientes  
14 denti

20 Zähne  
20 teeth  
20 dientes  
20 denti

30 Zähne  
30 teeth  
30 dientes  
30 denti

44 Zähne  
44 teeth  
44 dientes  
44 denti

62 Zähne  
62 teeth  
62 dientes  
62 denti



**40-446-01 - 40-446-05** 20,5 cm, 8"





- 40-446-11** Fig. 1 | 12T
- 40-446-12** Fig. 2 | 14T
- 40-446-13** Fig. 3 | 16T
- 40-446-14** Fig. 4 | 20T
- 40-446-15** Fig. 5 | 24T
- 40-446-16** Fig. 6 | 30T
- 40-446-17** Fig. 7 | 36T
- 40-446-18** Fig. 8 | 44T
- 40-446-19** Fig. 9 | 52T
- 40-446-20** Fig. 10 | 62T

T = Zähne  
 T = teeth  
 T = dientes  
 T = denti



**PARKS**

**40-446-11 - 40-446-20** 21,0 cm, 8 ¼"



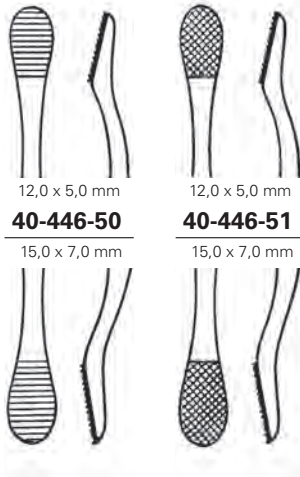
- 40-446-21** Fig. 1 | 12T
- 40-446-22** Fig. 2 | 14T
- 40-446-23** Fig. 3 | 16T
- 40-446-24** Fig. 4 | 20T
- 40-446-25** Fig. 5 | 24T
- 40-446-26** Fig. 6 | 30T
- 40-446-27** Fig. 7 | 36T
- 40-446-28** Fig. 8 | 44T
- 40-446-29** Fig. 9 | 52T
- 40-446-30** Fig. 10 | 62T

T = Zähne  
 T = teeth  
 T = dientes  
 T = denti



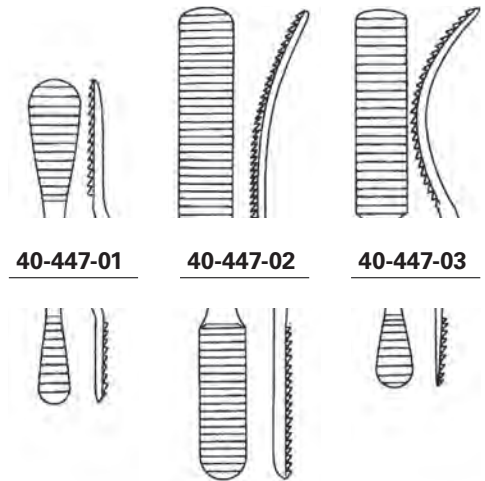
**MALTZ**

**40-446-21 - 40-446-30** 17,0 cm, 6 ¾"



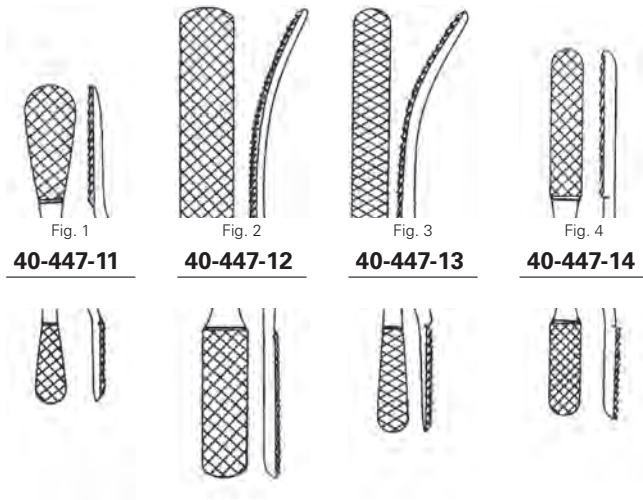
**MILLER**

**40-446-50 - 40-446-51** 19,0 cm, 7 ½"



**MILLER**

**40-447-01 - 40-447-03** 18,0 cm, 7"



**40-447-11**

**40-447-12**

**40-447-13**

**40-447-14**

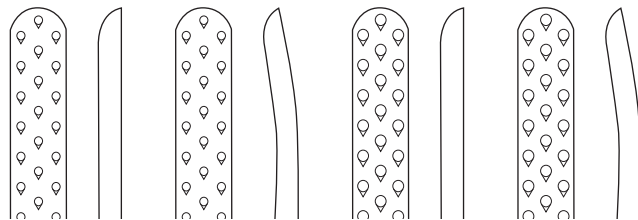


20,0 mm

**MILLER-COLBURN**

**40-447-11 - 40-447-14** 18,0 cm, 7 "

**40-448-22** 22,0 cm, 8 3/4 "



**40-447-51**

**40-447-53**

**40-447-52**

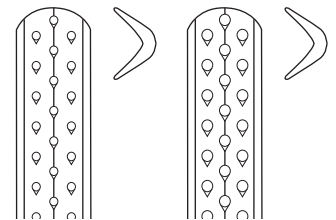
**40-447-54**

fein  
fine  
fina  
fina

fein  
fine  
fina  
fina

halbfine  
semi fine  
semifina  
semifina

halbfine  
semi fine  
semifina  
semifina



**40-447-55**

**40-447-56**

fein  
fine  
fina  
fina

halbfine  
semi fine  
semifina  
semifina

auf Druck schneidend, auf Zug schneidend  
 upwards stroke, downwards stroke  
 cortante a empuje, cortante a tracción  
 tagliente a urto, tagliente a trazione



**OBWEGESER**

**40-447-51 - 40-447-54** 19,5 cm, 7 3/4 "

**OBWEGESER**

**40-447-55 - 40-447-56** 19,5 cm, 7 3/4 "



13,0 mm

**40-449-24** 24,0 cm, 9 1/2"



20,0 mm

**40-449-28** 28,0 cm, 11"



20,0 mm

**PUTTI**

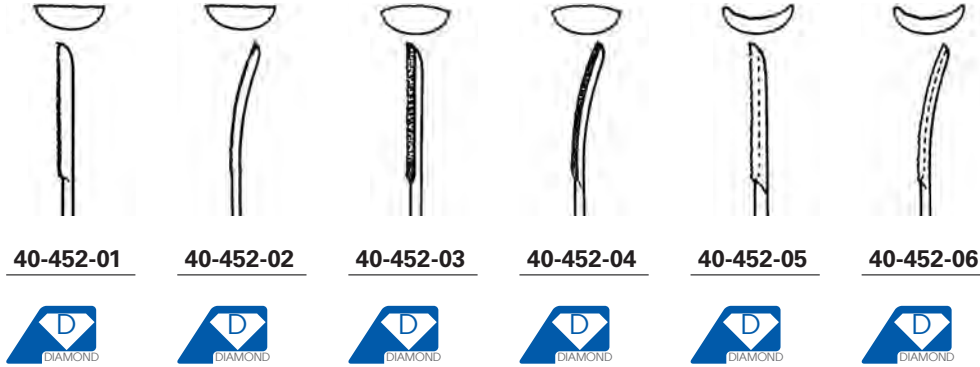
**40-451-27** 27,0 cm, 10 3/4"



10,0 mm

**PUTTI**

**40-451-30** 30,0 cm, 11 3/4"



**40-452-01**

**40-452-02**

**40-452-03**

**40-452-04**

**40-452-05**

**40-452-06**

mit Diamantaufgabe  
with diamond jaw  
con la quijada del diamante  
con la mascella del diamante

**40-452-01 - 40-452-06** 19,0 cm, 7 ½"



**40-453-20**

mit Diamantaufgabe  
with diamond jaw  
con la quijada del diamante  
con la mascella del diamante

**AUFRICHT**

**40-453-20** 20,0 cm, 8"



**40-454-21**

mit Diamantaufgabe  
with diamond jaw  
con la quijada del diamante  
con la mascella del diamante

**FOMON**

**40-454-21** 21,0 cm, 8 ¼"



<b>40-448-04</b>	Ø 4,0 mm
<b>40-448-05</b>	Ø 5,0 mm
<b>40-448-07</b>	Ø 7,0 mm
<b>40-448-10</b>	Ø 10,0 mm

**MOD. SCHWEDEN**

**40-448-04 - 40-448-10** 19,5 cm, 7 ¾ "



**40-459-01**

2,8 mm



**40-459-02**

3,2 mm



**LUCAS**

**40-459-01 - 40-459-02** 18,0 cm, 7 "



**40-460-00**



**JACOBSON**

**40-460-00** 14,0 cm, 5 ½ "



**MARTINI**

**40-460-01 - 40-460-03** 14,0 cm, 5 ½ "



Fig. 0010



Fig. 011



Fig. 112



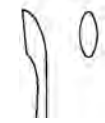
**JANSEN**

**40-460-05** 16,0 cm, 6 ¼ "



**40-460-05**





**40-460-06**



**BARTH**

**40-460-06** 18,0 cm, 7 "



**40-460-07**



**40-460-07** 21,0 cm, 8 ¼ "



**40-461-01**  
**40-461-02**  
**40-461-03**  
**40-461-04**



**VOLKMANN**

**40-461-01** 13,0 cm, 5 ⅛ "  
**40-461-02** 14,0 cm, 5 ½ "  
**40-461-03** 17,0 cm, 6 ¾ "  
**40-461-04** 20,0 cm, 8 "



**40-462-01**



**40-462-02**



**40-462-03**

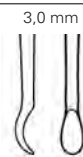


**VOLKMANN**

**40-462-01** 13,0 cm, 5 ⅛ "  
**40-462-02** 16,0 cm, 6 ¼ "  
**40-462-03** 20,0 cm, 8 "



**40-463-01**



**MILLER**

**40-463-01** 18,0 cm, 7 "

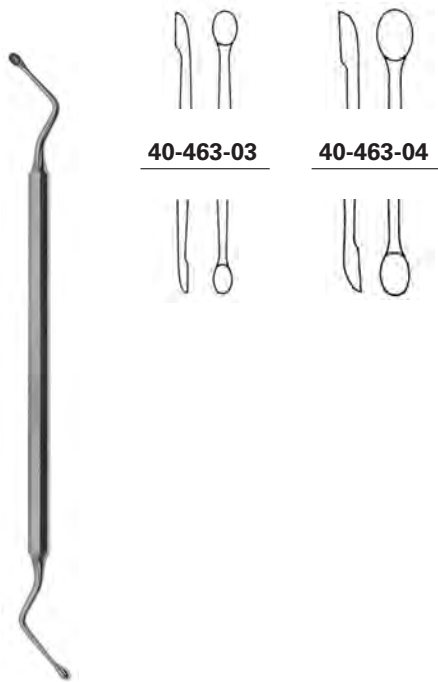


**40-463-02**



**JANSEN**

**40-463-02** 16,0 cm, 6 ¼ "



**40-463-03**

**40-463-04**

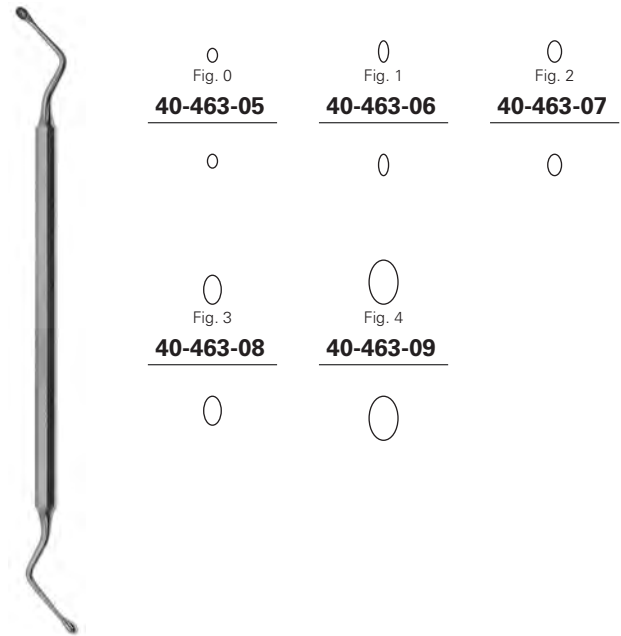


Fig. 0  
**40-463-05**

Fig. 1  
**40-463-06**

Fig. 2  
**40-463-07**

Fig. 3  
**40-463-08**

Fig. 4  
**40-463-09**

**HEMINGWAY**

**40-463-03 - 40-463-04** 17,0 cm, 6 3/4"

**HEMINGWAY**

**40-463-05 - 40-463-09** 17,0 cm, 6 3/4"

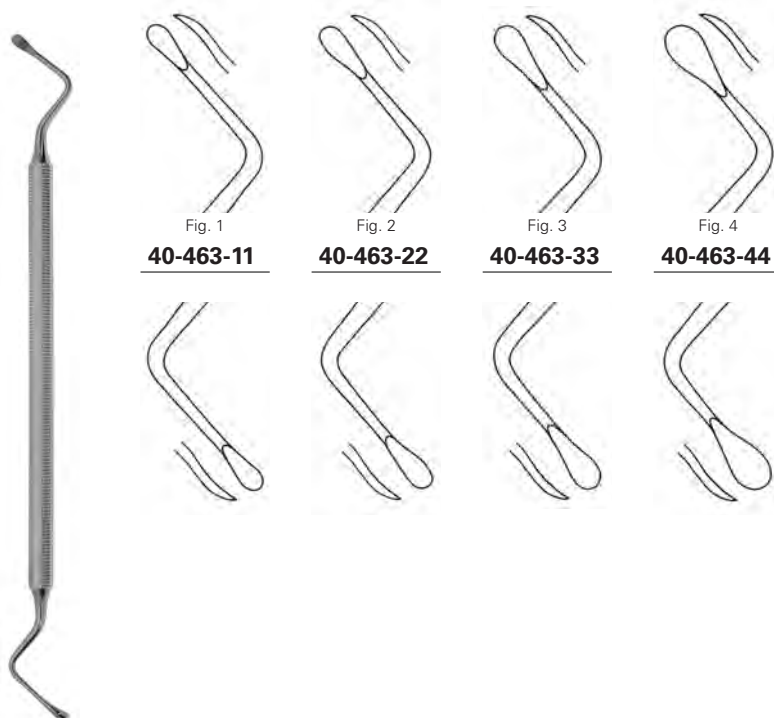


Fig. 1  
**40-463-11**

Fig. 2  
**40-463-22**

Fig. 3  
**40-463-33**

Fig. 4  
**40-463-44**

**HEMINGWAY**

**40-463-11 - 40-463-44** 18,0 cm, 7"

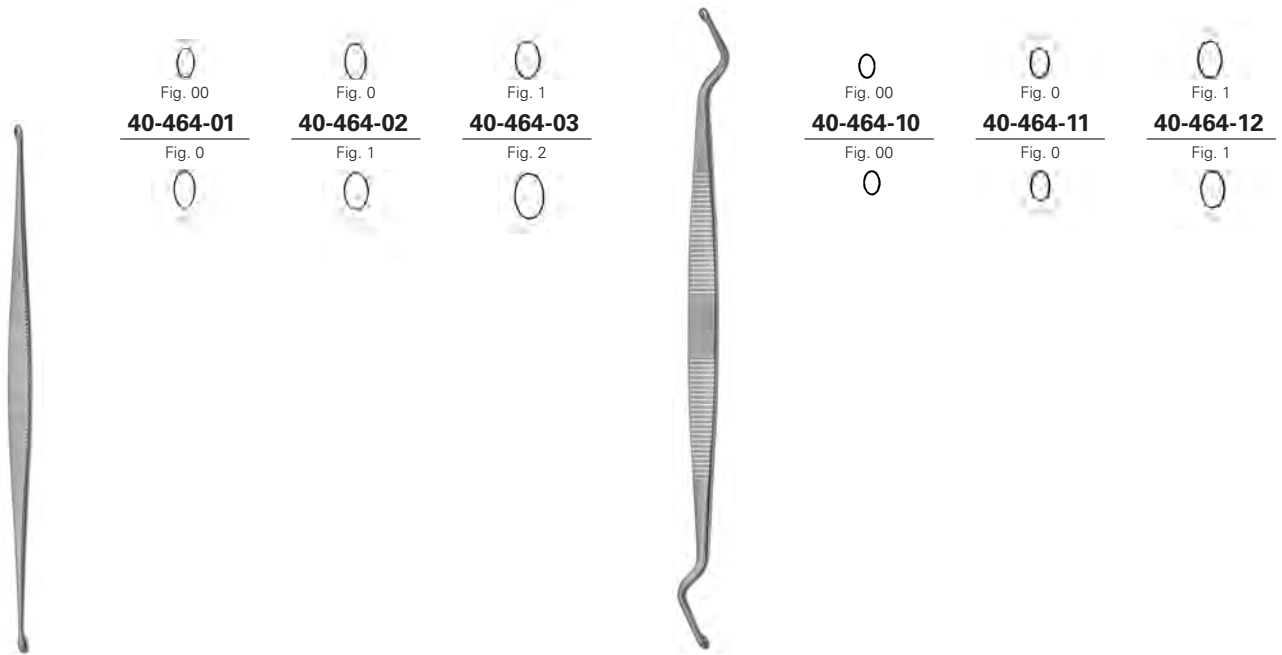


Fig. 00  
**40-464-01**  
Fig. 0

Fig. 0  
**40-464-02**  
Fig. 1

Fig. 1  
**40-464-03**  
Fig. 2

Fig. 00  
**40-464-10**  
Fig. 00

Fig. 0  
**40-464-11**  
Fig. 0

Fig. 1  
**40-464-12**  
Fig. 1

**WILLIGER**

**40-464-01 - 40-464-03** 13,0 cm, 5 1/8"

**WILLIGER**

**40-464-10 - 40-464-12** 17,0 cm, 6 3/4"

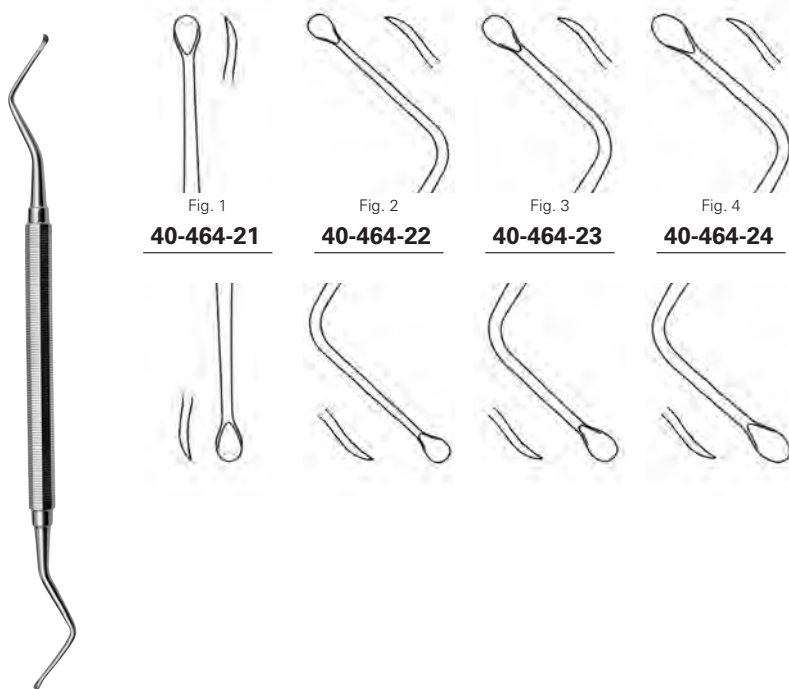


Fig. 1  
**40-464-21**

Fig. 2  
**40-464-22**

Fig. 3  
**40-464-23**

Fig. 4  
**40-464-24**

**MILLER-COLBURN**

**40-464-21 - 40-464-24** 17,0 cm, 6 3/4"





Fig. 5

**40-465-09**

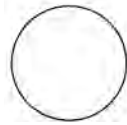


Fig. 6

**40-465-10**



Fig. 3

**40-465-07**



Fig. 4

**40-465-08**



Fig. 1

**40-465-05**



Fig. 2

**40-465-06**



Fig. 00

**40-465-03**



Fig. 0

**40-465-04**



Fig. 4

**40-466-08**



Fig. 2

**40-466-06**



Fig. 3

**40-466-07**



Fig. 0

**40-466-04**



Fig. 1

**40-466-05**



Fig. 0000

**40-465-01**



Fig. 000

**40-465-02**



Fig. 000

**40-466-02**



Fig. 00

**40-466-03**



**BRUNS**

**40-465-01 - 40-465-10** 17,0 cm, 6 3/4"



**SCHEDE**

**40-466-02 - 40-466-08** 17,0 cm, 6 3/4"



Fig. 5

**40-467-09**



Fig. 6

**40-467-10**



Fig. 3

**40-467-07**



Fig. 4

**40-467-08**



Fig. 1

**40-467-05**



Fig. 2

**40-467-06**



Fig. 00

**40-467-03**



Fig. 0

**40-467-04**



Fig. 1 | 3,4 mm

**40-466-13**



Fig. 2 | 5,2 mm

**40-466-15**



Fig. 0000

**40-467-01**



Fig. 000

**40-467-02**

**WILLIGER**

**40-466-13 - 40-466-15** 17,0 cm, 6 3/4"

**VOLKMANN**

**40-467-01 - 40-467-10** 17,0 cm, 6 3/4"



Fig. 5

**40-468-09**



Fig. 6

**40-468-10**



Fig. 5

**40-468-18**



Fig. 6

**40-468-19**



Fig. 3

**40-468-07**



Fig. 4

**40-468-08**



Fig. 3

**40-468-16**



Fig. 4

**40-468-17**



Fig. 1

**40-468-05**



Fig. 2

**40-468-06**



Fig. 1

**40-468-14**



Fig. 2

**40-468-15**



Fig. 00

**40-468-03**



Fig. 0

**40-468-04**



Fig. 00

**40-468-12**



Fig. 0

**40-468-13**



Fig. 0000

**40-468-01**



Fig. 000

**40-468-02**



Fig. 000

**40-468-11**



**SPRATT**

**40-468-01 - 40-468-10** 17,0 cm, 6 3/4"



**SPRATT**

**40-468-11 - 40-468-19** 20,0 cm, 8"



3,3 mm

**40-469-06**



2,7 mm

**40-469-04**



3,0 mm

**40-469-05**



2,0 mm

**40-469-02**



2,4 mm

**40-469-03**



1,0 mm

**40-469-00**



1,7 mm

**40-469-01**



Fig. 3 | 6,0 mm

**40-470-03**



Fig. 1 | 4,0 mm

**40-470-01**



Fig. 2 | 5,0 mm

**40-470-02**



**LEMPERT**

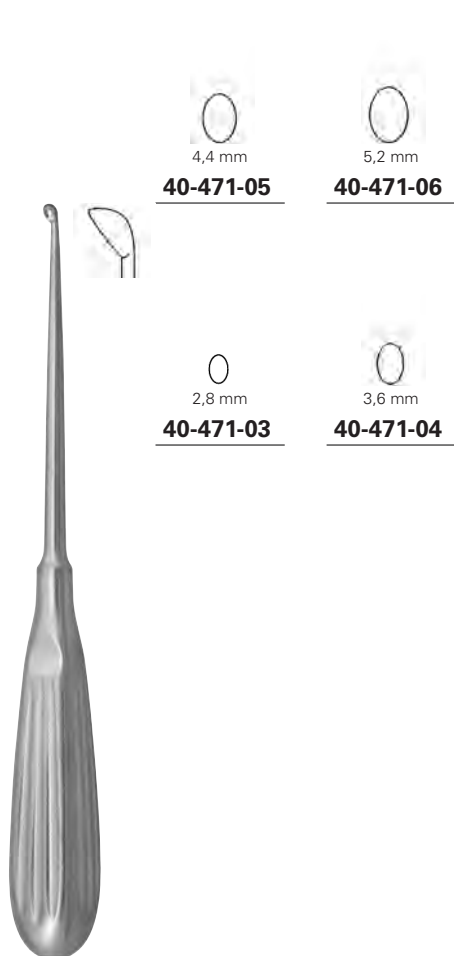
**40-469-00 - 40-469-06** 21,0 cm, 8 ¼"



biegsam  
 malleable  
 malleable  
 maleable  
 malleabile

**HALLE**

**40-470-01 - 40-470-03** 21,0 cm, 8 ¼"



### DAUBENSPECK

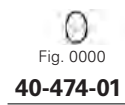
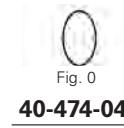
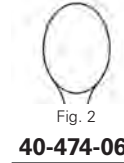
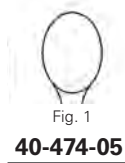
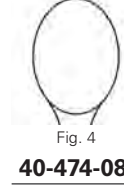
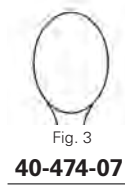
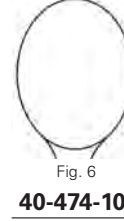
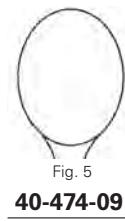
**40-471-03 - 40-471-06** 20,0 cm, 8"



**40-472-02 - 40-472-05** 25,0 cm, 9 3/4"



**40-473-02 - 40-473-05** 25,0 cm, 9 3/4"



**SIMON**

**40-474-01 - 40-474-10** 24,0 cm, 9 1/2"



**CASPAR**

**40-475-02 - 40-475-04** 22,0 cm, 8 3/4 "



**CASPAR**

**40-475-02 P - 40-475-04 P** 22,0 cm, 8 3/4 "



**CASPAR**

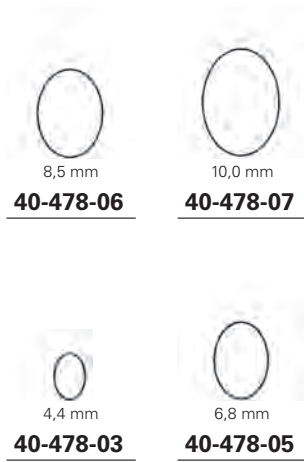
**40-476-02 - 40-476-04** 22,0 cm, 8 3/4"



**CASPAR**

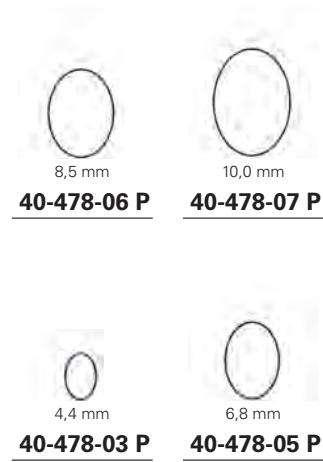
**40-476-02 P - 40-476-04 P** 22,0 cm, 8 3/4"





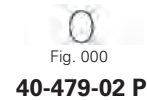
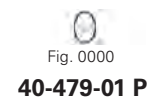
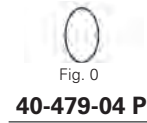
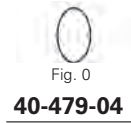
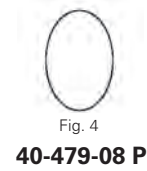
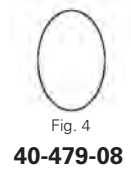
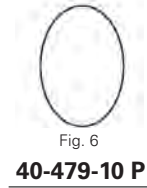
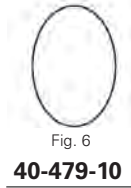
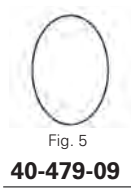
### CASPAR

**40-478-03 - 40-478-07** 27,0 cm, 10<sup>3</sup>/<sub>4</sub>"



### CASPAR

**40-478-03 P - 40-478-07 P** 27,0 cm, 10<sup>3</sup>/<sub>4</sub>"



**VOLKMANN**

**40-479-01 - 40-479-10** 18,5 cm, 7 ¼"



**VOLKMANN**

**40-479-01 P - 40-479-10 P** 18,5 cm, 7 ¼"



### VOLKMANN

**40-480-04 - 40-480-09** 27,5 cm, 10<sup>3</sup>/<sub>4</sub>"



### VOLKMANN

**40-480-04 P - 40-480-09 P** 27,5 cm, 10<sup>3</sup>/<sub>4</sub>"



**40-481-03**



**40-481-01**



**40-481-02**

**SCOVILLE**

**40-481-01 - 40-481-03** 25,0 cm, 9 3/4"



Fig. 5

**40-482-09**



Fig. 6

**40-482-10**



Fig. 3

**40-482-07**



Fig. 4

**40-482-08**



Fig. 1

**40-482-05**



Fig. 2

**40-482-06**



Fig. 00

**40-482-03**



Fig. 0

**40-482-04**



Fig. 0000

**40-482-01**

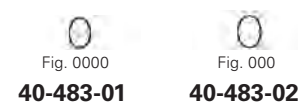
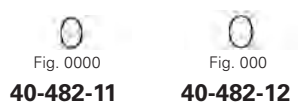
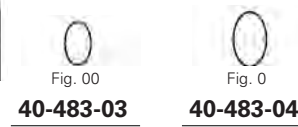
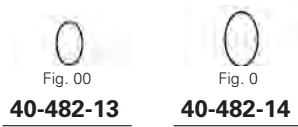
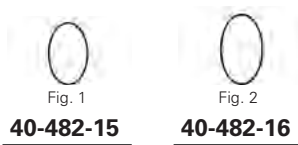
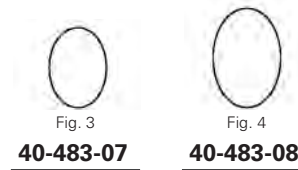
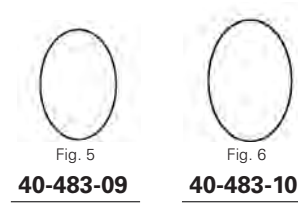
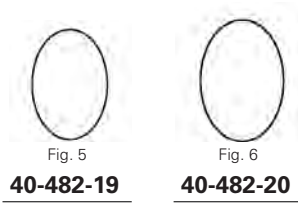


Fig. 000

**40-482-02**

**BRUNS**

**40-482-01 - 40-482-10** 23,0 cm, 9"



**BRUNS**

**40-482-11 - 40-482-20** 23,0 cm, 9"

**BRUNS**

**40-483-01 - 40-483-10** 23,0 cm, 9"



Fig. 1

**40-484-01**



Fig. 2

**40-484-02**



Fig. 3

**40-484-03**



Fig. 4

**40-484-04**



Fig. 5

**40-484-05**



Fig. 6

**40-484-06**

**MOD. USA**

**40-484-01 - 40-484-06** 16,0 cm, 6 ¼"



Fig. 5

**40-485-05**



Fig. 6

**40-485-06**



Fig. 3

**40-485-03**



Fig. 4

**40-485-04**



Fig. 1

**40-485-01**



Fig. 2

**40-485-02**



**MOD. USA**

**40-485-01 - 40-485-06** 16,0 cm, 6 ¼"



Fig. 5

**40-486-05**



Fig. 6

**40-486-06**



Fig. 3

**40-486-03**



Fig. 4

**40-486-04**



Fig. 1

**40-486-01**



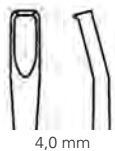
Fig. 2

**40-486-02**



**MOD. USA**

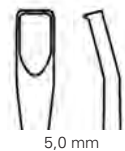
**40-486-01 - 40-486-06** 16,0 cm, 6 ¼"



4,0 mm

**40-490-04**

gezahnt  
serrated  
dentado  
dentellato



5,0 mm

**40-490-05**

gezahnt  
serrated  
dentado  
dentellato

Küretten  
Curettes  
Curetas  
Curette

**CASPAR**

**40-490-04 - 40-490-05** 25,0 cm, 10"



3,0 mm

**40-491-03**

gezahnt  
serrated  
dentado  
dentellato



4,0 mm

**40-491-04**

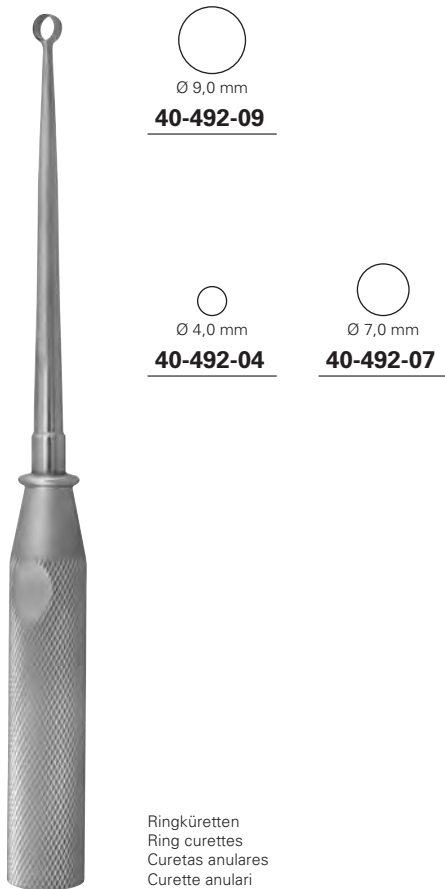
gezahnt  
serrated  
dentado  
dentellato

Küretten  
Curettes  
Curetas  
Curette

**CASPAR**

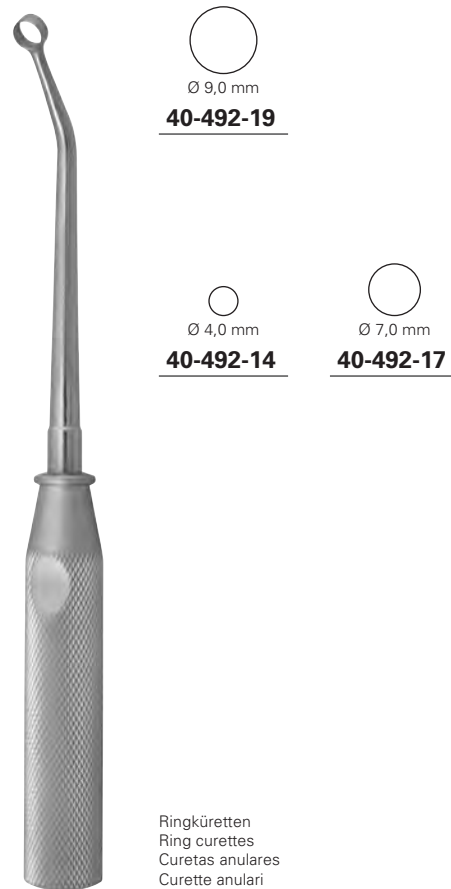
**40-491-03 - 40-491-04** 27,0 cm, 10 3/4"





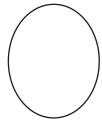
## CONE

**40-492-04 - 40-492-09** 23,0 cm, 9"



## CONE

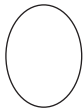
**40-492-14 - 40-492-19** 23,0 cm, 9"



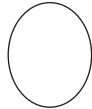
12,2 x 15,2 mm  
**40-494-09**



10,5 x 16,8 mm  
**40-494-18**



10,2 x 13,7 mm  
**40-494-07**



11,2 x 14,0 mm  
**40-494-08**



8,5 x 12,5 mm  
**40-494-16**



9,5 x 14,5 mm  
**40-494-17**



8,1 x 10,2 mm  
**40-494-05**



9,1 x 11,4 mm  
**40-494-06**



6,0 x 9,0 mm  
**40-494-14**



7,0 x 11,0 mm  
**40-494-15**



6,1 x 7,6 mm  
**40-494-03**



7,1 x 8,9 mm  
**40-494-04**



4,5 x 6,4 mm  
**40-494-12**



5,0 x 8,0 mm  
**40-494-13**



4,0 x 5,0 mm  
**40-494-01**



5,0 x 6,4 mm  
**40-494-02**



3,0 x 5,0 mm  
**40-494-10**



3,5 x 5,5 mm  
**40-494-11**



Küretten  
Curettes  
Curetas  
Curette

**COBB**

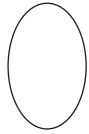
**40-494-01 - 40-494-09** 28,0 cm, 11 "



Scharfe Löffel  
Bone curettes  
Cucharillas cortantes  
Curette per ossa

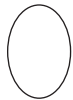
**HATFIELD**

**40-494-10 - 40-494-18** 23,0 cm, 9 "



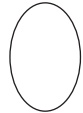
10,5 x 16,8 mm

**40-494-28**



8,5 x 12,5 mm

**40-494-26**



9,5 x 14,5 mm

**40-494-27**



6,0 x 9,0 mm

**40-494-24**



7,0 x 11,0 mm

**40-494-25**



4,5 x 6,4 mm

**40-494-22**



5,0 x 8,0 mm

**40-494-23**



3,0 x 5,0 mm

**40-494-20**



3,5 x 5,5 mm

**40-494-21**



5,0 mm

**40-498-03**



3,0 mm

**40-498-01**



4,0 mm

**40-498-02**



Scharfe Löffel  
 Bone currettes  
 Cucharillas cortantes  
 Curette per ossa



Scharfe Löffel  
 Bone currettes  
 Cucharillas cortantes  
 Curette per ossa

## HATFIELD

**40-494-20 - 40-494-28** 28,0 cm, 11 "

## BUSHE

**40-498-01 - 40-498-03** 25,0 cm, 10 "



**40-495-01**

**UFFENORDE**

**40-495-01** 17,0 cm, 6 3/4"



**40-495-02**

**UFFENORDE**

**40-495-02** 17,0 cm, 6 3/4"



**40-496-01**



**40-496-02**

**KERPEL**

**40-496-01 - 40-496-02** 14,5 cm, 5 3/4"



**40-497-01**



**40-497-02**

**KERPEL**

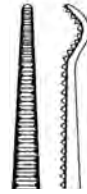
**40-497-01 - 40-497-02** 14,5 cm, 5 3/4"



**40-501-01**



**40-501-01** 9,5 cm, 3 ¾"



**40-502-14**



**40-502-14** 14,0 cm, 5 ½"



**40-503-13** 13,5 cm, 5 ¼"

für Kieferrepositionen  
 for maxillary reposition  
 para la reducción maxilar  
 per riposizione mascellare



**40-506-12**



**40-505-13** 13,5 cm, 5 ¼"



**40-506-12** 12,0 cm, 4 ¾"

für Unterkieferfrakturen  
 for mandibular fractures  
 para fracturas del mandibulo  
 per fratture mandibulare



**HAASE**

**40-507-16** 16,5 cm, 4 ¾"



**LEWIN**

**40-508-17** 17,5 cm, 7"



**REILL**

**40-511-17** 17,0 cm, 6 3/4"



**40-513-20** 20,5 cm, 8"



Ø 1,0 mm

**40-515-01**

**MEYER**

**40-515-01** 17,0 cm, 6 3/4"



Ø 2,0 mm

**40-515-02**

**MEYER**

**40-515-02** 20,5 cm, 8"

Patellazangen, Knöchelfasszangen, Knochenhaltezange  
 Patella forceps, Malleolar forceps, Bone holding forceps  
 Pinza para rotula, Pinzas para el maleolo, Pinza para huesos  
 Pinza per rotula, Pinze per malleolo, Tenaglie per ossa



**40-516-18**  
**40-516-21**

Patellazangen  
 Patella forceps  
 Pinza para rotula  
 Pinza per rotula



**40-518-21**

Knöchelfasszange  
 Malleolar forceps  
 Pinza para el maleolo  
 Pinza per malleolo

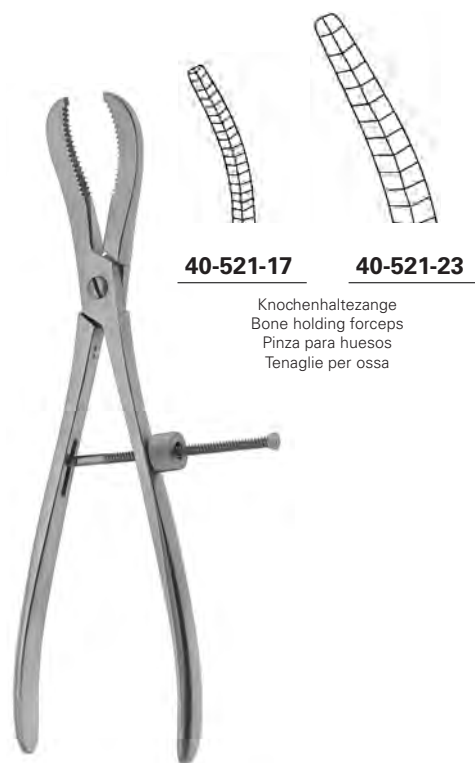


Knochenhaltezange  
 Bone holding forceps  
 Pinza para huesos  
 Tenaglie per ossa

**40-516-18** 18,5 cm, 7 ¼"  
**40-516-21** 21,0 cm, 8 ¼"

**40-518-21** 21,0 cm, 8 ¼"

**40-519-18** 18,0 cm, 7"



**40-521-17**

**40-521-23**

Knochenhaltezange  
 Bone holding forceps  
 Pinza para huesos  
 Tenaglie per ossa



**40-523-18**

Knochenhaltezange  
 Bone holding forceps  
 Pinza para huesos  
 Tenaglie per ossa



**40-523-19**

Knochenhaltezange  
 Bone holding forceps  
 Pinza para huesos  
 Tenaglie per ossa

**40-521-17** 17,0 cm, 6 ¾"  
**40-521-23** 23,5 cm, 9 ¼"

**DINGMANN**

**40-523-18** 18,5 cm, 7 ¼"

**DINGMANN MODIF.**

**40-523-19** 18,5 cm, 7 ¼"



Sequesterzangen  
 Sequestrum forceps  
 Pinzas para secuestro  
 Pinze per frammento osseo

**40-524-20** 20,0 cm, 8"



Sequesterzangen  
 Sequestrum forceps  
 Pinzas para secuestro  
 Pinze per frammento osseo

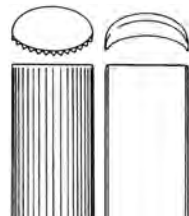
**40-525-20** 20,0 cm, 8"



Sequesterzangen  
 Sequestrum forceps  
 Pinzas para secuestro  
 Pinze per frammento osseo

**VAN BUREN**

**40-527-23** 23,0 cm, 9"



11,0 mm

**40-526-22**

Knochenformzange  
 Bone contouring forceps  
 Pinza para formar huesos  
 Pinza per formare osso

**TESSIER**

**40-526-22** 22,0 cm, 8 3/4"



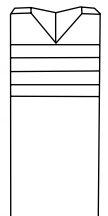
5,0 mm

**40-528-20**

Knochenhaltezange  
 Bone holding forceps  
 Pinza para huesos  
 Tenaglie per ossa

**LANGENBECK**

**40-528-20** 20,0 cm, 8"



11,0 mm

**40-530-20**

Knochenhaltezange  
 Bone holding forceps  
 Pinza para huesos  
 Tenaglie per ossa

**LANGENBECK**

**40-530-20** 20,0 cm, 8"





12,0 mm  
**40-532-20**

**FERGUSSON**

**40-532-20** 20,5 cm, 8 "



8,0 mm  
**40-533-19**

**SEMB**

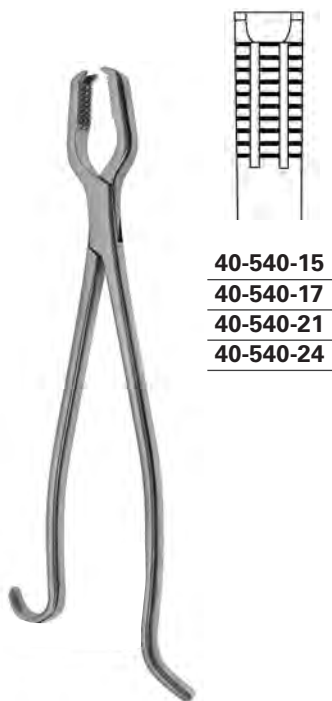
**40-533-19** 19,0 cm, 7 ½ "



8,0 mm  
**40-535-19**

**SEMB**

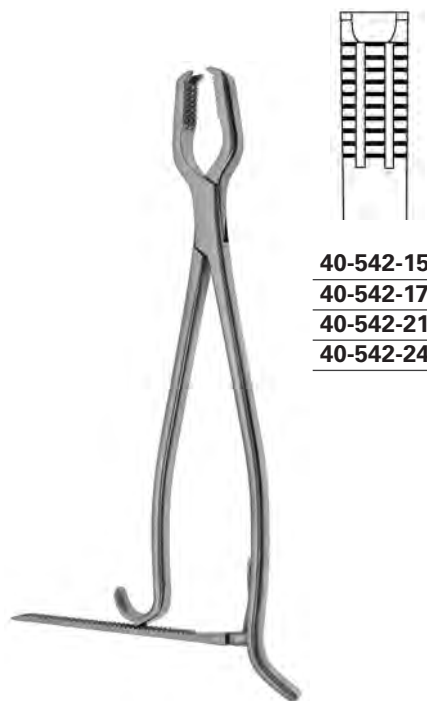
**40-535-19** 19,0 cm, 7 ½ "



**40-540-15**  
**40-540-17**  
**40-540-21**  
**40-540-24**

**KERN-LANE**

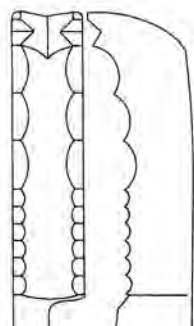
**40-540-15** 15,0 cm, 6 "  
**40-540-17** 17,0 cm, 6 ¾ "  
**40-540-21** 21,0 cm, 8 ¼ "  
**40-540-24** 24,0 cm, 9 ½ "



**40-542-15**  
**40-542-17**  
**40-542-21**  
**40-542-24**

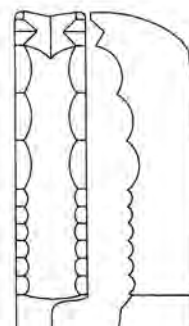
**KERN-LANE**

**40-542-15** 15,0 cm, 6 "  
**40-542-17** 17,0 cm, 6 ¾ "  
**40-542-21** 21,0 cm, 8 ¼ "  
**40-542-24** 24,0 cm, 9 ½ "



**40-536-23** 9,0 mm  
**40-536-25** 11,0 mm

verstellbar  
adjustable  
ajustable  
regolabili



11,0 mm  
**40-538-25**

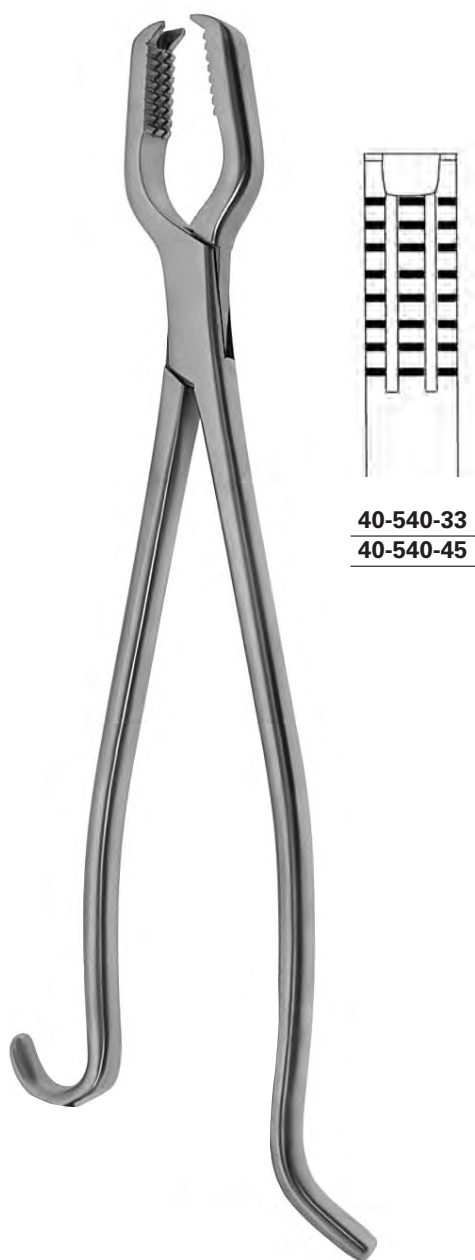
verstellbar  
adjustable  
ajustable  
regolabili

### FARABEUF

**40-536-23** 23,0 cm, 9 "  
**40-536-25** 25,5 cm, 10 "

### FARABEUF-LAMBOTTE

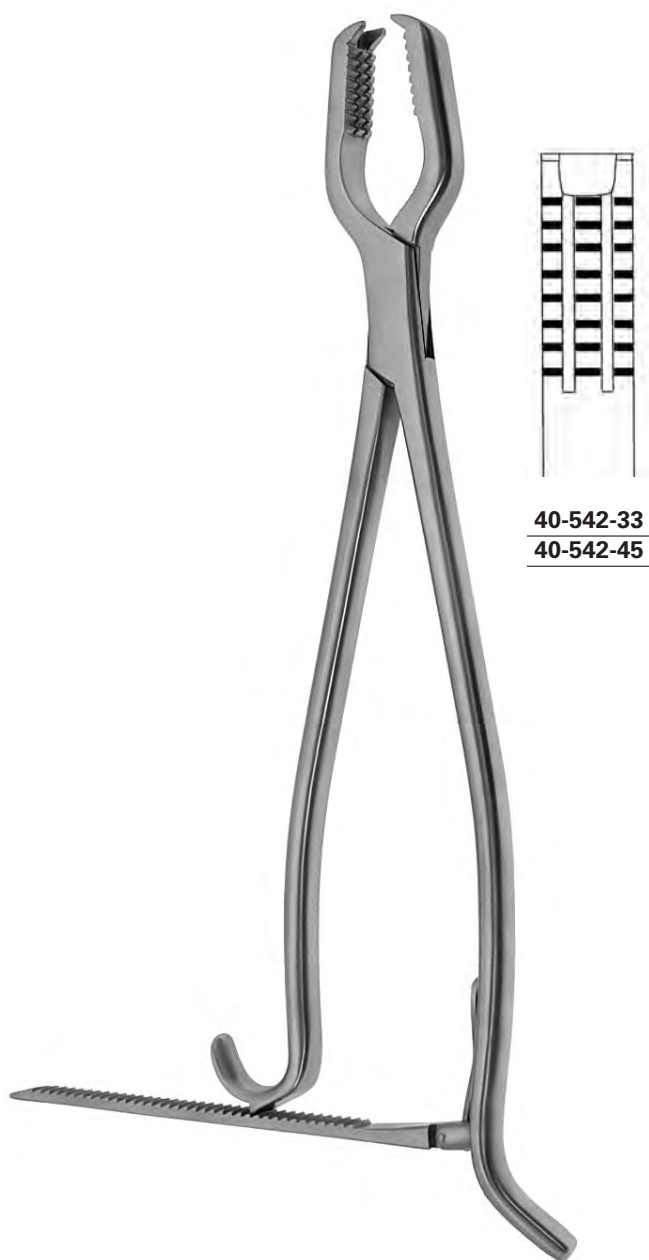
**40-538-25** 25,5 cm, 10 "



**40-540-33**  
**40-540-45**

### **KERN-LANE**

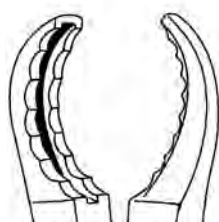
**40-540-33** 33,0 cm, 13 "  
**40-540-45** 45,0 cm, 17 <sup>3</sup>/<sub>4</sub> "



**40-542-33**  
**40-542-45**

### **KERN-LANE**

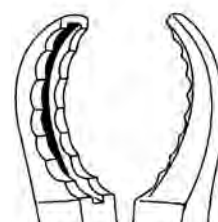
**40-542-33** 33,0 cm, 13 "  
**40-542-45** 45,0 cm, 17 <sup>3</sup>/<sub>4</sub> "



**40-546-18**  
**40-546-23**  
**40-546-25**  
**40-546-28**

**ULRICH**

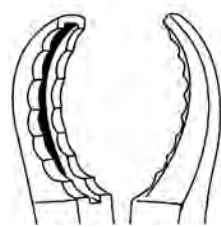
<b>40-546-18</b>	18,0 cm, 7 "
<b>40-546-23</b>	23,0 cm, 9 "
<b>40-546-25</b>	25,0 cm, 9 ¾ "
<b>40-546-28</b>	28,0 cm, 11 "



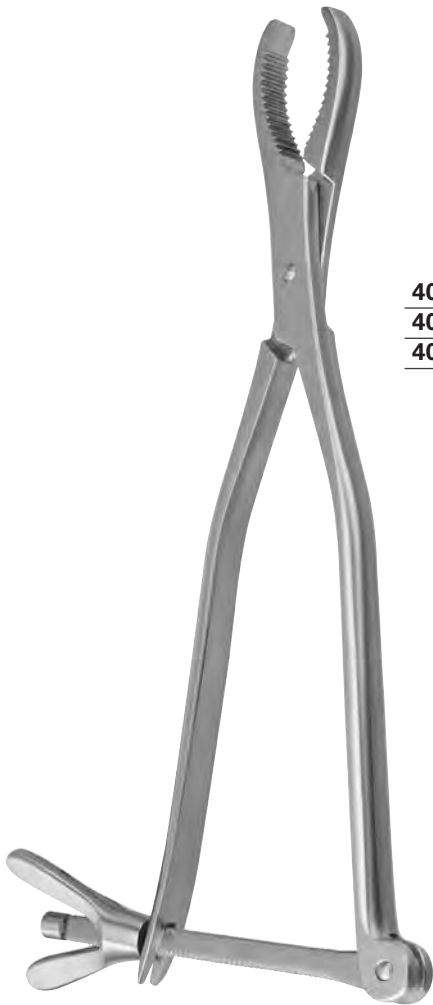
**40-547-22**  
**40-547-24**  
**40-547-28**

**ULRICH**

<b>40-547-22</b>	22,0 cm, 8 ¾ "
<b>40-547-24</b>	24,0 cm, 9 ½ "
<b>40-547-28</b>	28,0 cm, 11 "

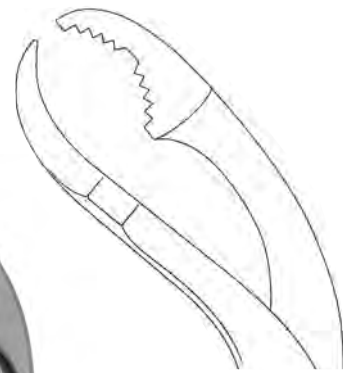


<b>40-548-21</b>	6,5 mm
<b>40-548-27</b>	7,5 mm
<b>40-548-30</b>	8,5 mm



### HEY-GROVES

<b>40-548-21</b>	21,0 cm, 8 ¼ "
<b>40-548-27</b>	27,0 cm, 10 ¾ "
<b>40-548-30</b>	30,5 cm, 12 "

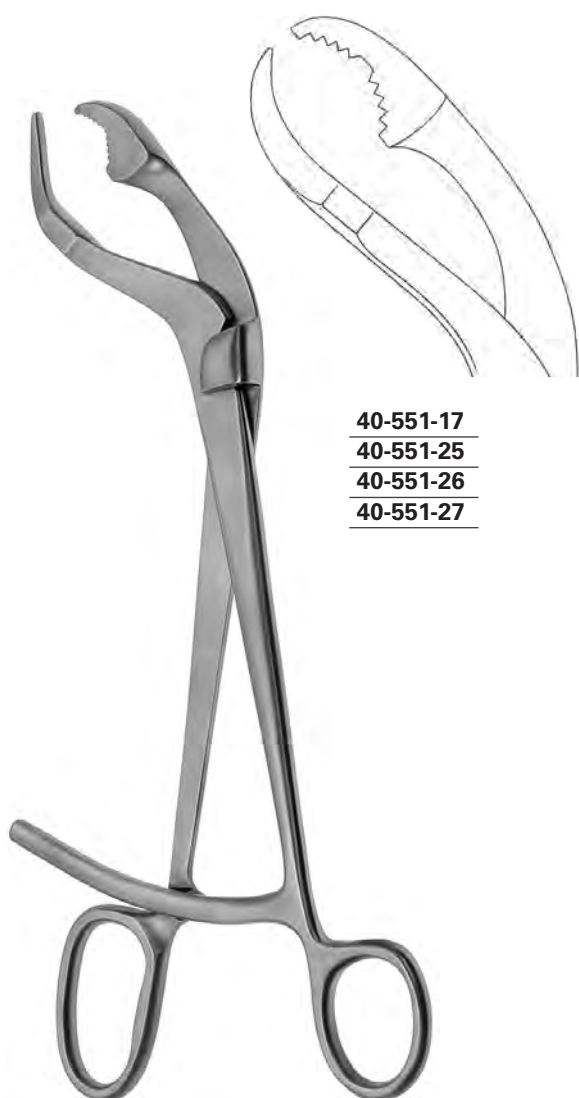


<b>40-549-15</b>
<b>40-549-19</b>
<b>40-549-24</b>
<b>40-549-26</b>
<b>40-549-28</b>



selbstzentrierend  
 self-centering  
 autocentrante  
 autocentranti

<b>40-549-15</b>	15,0 cm, 6 "
<b>40-549-19</b>	19,0 cm, 7 ½ "
<b>40-549-24</b>	24,0 cm, 9 ½ "
<b>40-549-26</b>	26,0 cm, 10 ½ "
<b>40-549-28</b>	28,0 cm, 11 "



40-551-17  
40-551-25  
40-551-26  
40-551-27

### VERBRUGGE

<b>40-551-17</b>	17,0 cm, 6 $\frac{3}{4}$ "
<b>40-551-25</b>	25,0 cm, 10 "
<b>40-551-26</b>	26,0 cm, 10 $\frac{1}{2}$ "
<b>40-551-27</b>	27,0 cm, 10 $\frac{3}{4}$ "



verstellbar  
adjustable  
ajustable  
regolabili

### LAMBOTTE

<b>40-552-22</b>	22,0 cm, 8 $\frac{3}{4}$ "
<b>40-552-27</b>	27,0 cm, 10 $\frac{3}{4}$ "
<b>40-552-30</b>	30,0 cm, 12 "



### LAMBOTTE

<b>40-554-22</b>	22,0 cm, 8 3/4 "
<b>40-554-26</b>	26,0 cm, 10 1/4 "
<b>40-554-33</b>	33,0 cm, 13 "



verstellbar  
adjustable  
ajustable  
regolabili

### LAMBOTTE

<b>40-555-19</b>	19,0 cm, 7 1/2 "
<b>40-555-23</b>	23,0 cm, 9 "
<b>40-555-26</b>	26,0 cm, 10 1/4 "



**LOWMAN**

<b>40-561-12</b>	12,0 cm, 4 3/4"
<b>40-561-18</b>	18,0 cm, 7"
<b>40-561-20</b>	20,0 cm, 8"
<b>40-561-22</b>	22,0 cm, 8 3/4"



**LOWMAN-HOGLUND**

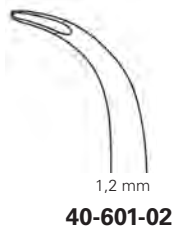
<b>40-563-12</b>	12,0 cm, 4 3/4"
<b>40-563-18</b>	18,0 cm, 7"
<b>40-563-20</b>	20,0 cm, 8"

Distraktionsklammer für Knochenhalteklammern  
 Traction bar for bone clamps  
 Barra de tracción para pinzas porta-huesos  
 Barra di trazione per tenaglie per ossa

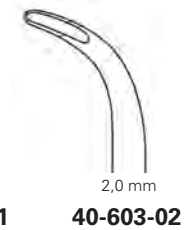


**GERSTER**

<b>40-564-00</b>	15,0 cm, 6"
------------------	-------------



<b>40-601-01 - 40-601-02</b>	13,0 cm, 5 1/8"
------------------------------	-----------------



<b>40-603-01 - 40-603-02</b>	13,0 cm, 5 1/8"
------------------------------	-----------------





**40-603-14**



**KLEINERT-KUTZ**

**40-603-14** 14,0 cm, 5 ½"



**40-604-01**



**HEANLEY**

**40-604-01** 18,0 cm, 7"



**40-605-01**



**40-605-02**



**STELLBRINK**

**40-605-01** 17,5 cm, 8"

**40-605-02** 16,5 cm, 6 ½"



**40-607-12**



**FRIEDMANN-MINI**

**40-607-12** 12,5 cm, 5"



**40-607-14**

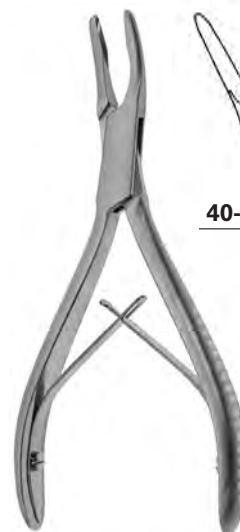


**LUER-FRIEDMANN**

**40-607-14** 14,5 cm, 5 ¾"

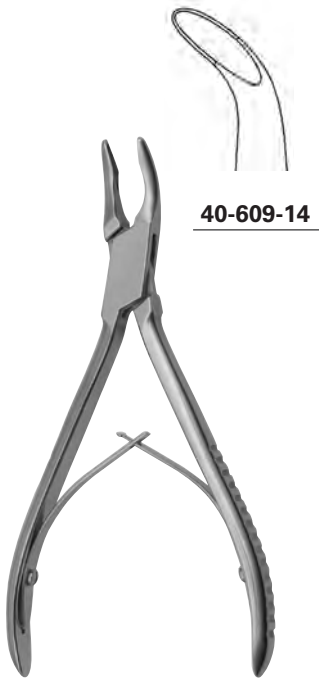


**40-608-14**



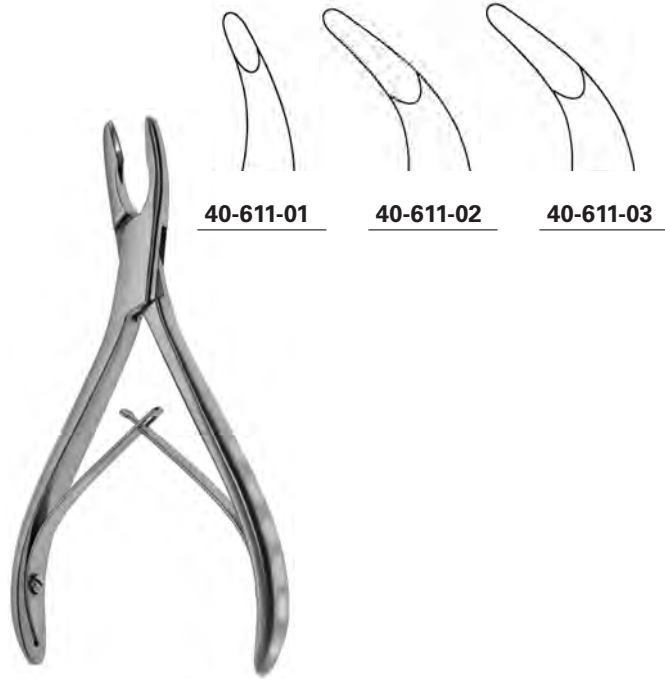
**FRIEDMANN-VICKERS**

**40-608-14** 14,0 cm, 5 ½"



**40-609-14**

**40-609-14** 14,0 cm, 5 ½"



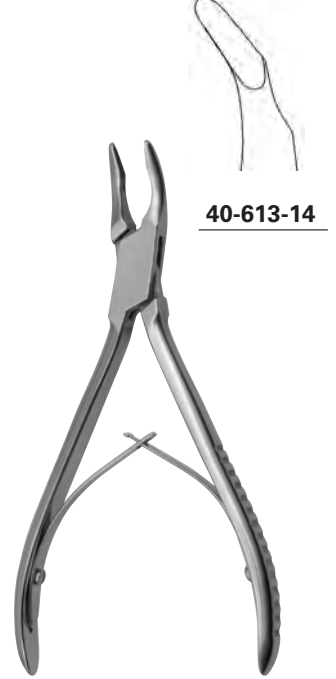
**40-611-01**

**40-611-02**

**40-611-03**

**LUER**

**40-611-01 - 40-611-03** 15,0 cm, 6"



**40-613-14**

**CLEVELAND**

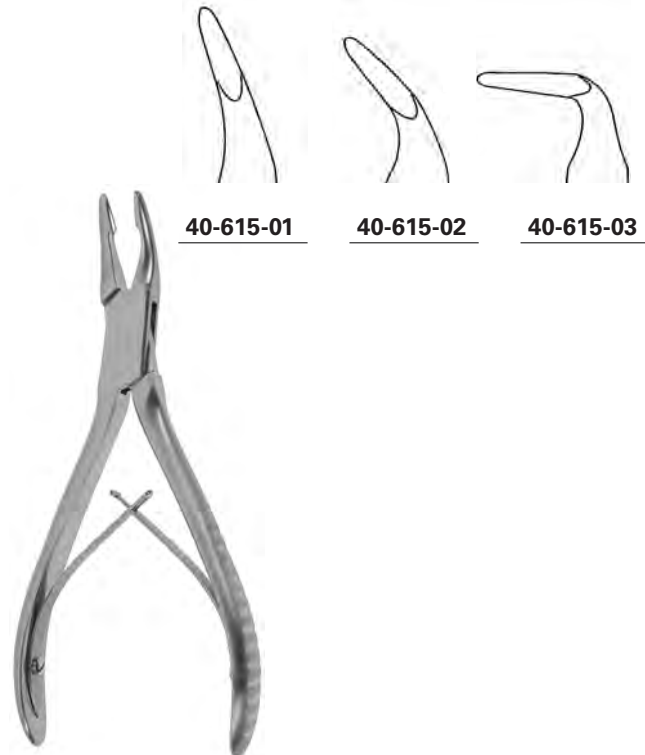
**40-613-14** 14,0 cm, 5 ½"



**40-613-17**

**CLEVELAND**

**40-613-17** 17,0 cm, 6 ¾"



**40-615-01**

**40-615-02**

**40-615-03**

**BLUMENTHAL**

**40-615-01 - 40-615-03** 15,5 cm, 6 ⅞"



**40-616-17**

**HAKANSSON**

**40-616-17** 17,0 cm, 6 ¾"



**JANSEN**

**40-617-16 - 40-618-17** 17,5 cm, 6 ¾ "



**JANSEN**

**40-617-19** 19,0 cm, 7 ½ "



**HARTMANN**

**40-619-17** 17,0 cm, 6 ¾ "



**BACON**

**40-621-19** 19,5 cm, 7 ¾ "



**40-622-16**  
**40-622-20**



**40-623-16**  
**40-623-20**

**LEMPERT**

**40-622-16 - 40-623-16** 16,0 cm, 6 ¼"  
**40-622-20 - 40-623-20** 20,0 cm, 8"



**40-625-18**

**BEYER**

**40-625-18** 18,0 cm, 7"



**40-627-01**



**40-627-02**

**MEAD**

**40-627-01 - 40-627-02** 16,5 cm, 6 ½"



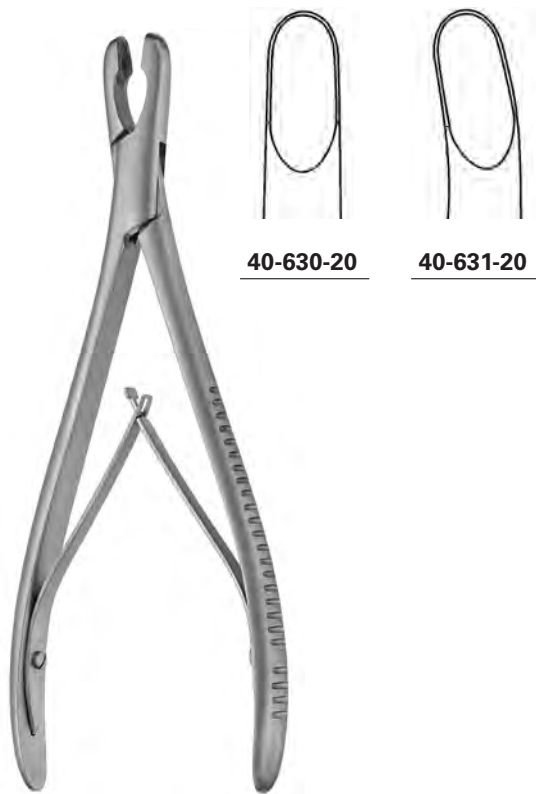
**40-628-17**



**40-629-17**

**LUER**

**40-628-17 - 40-629-17** 17,5 cm, 7"

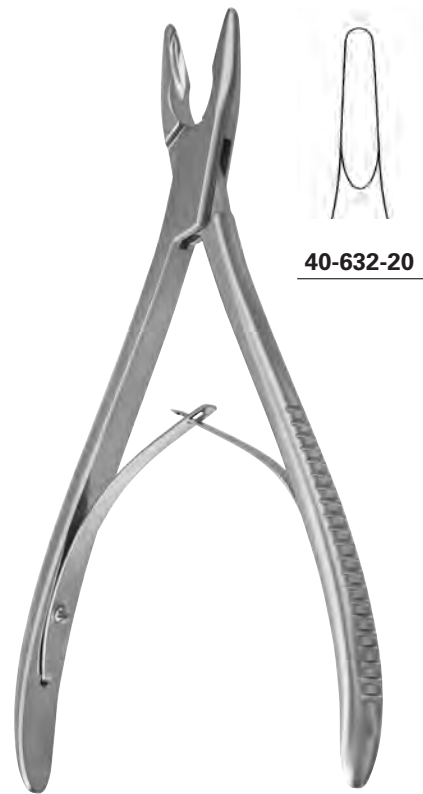


**40-630-20**

**40-631-20**

**ADSON**

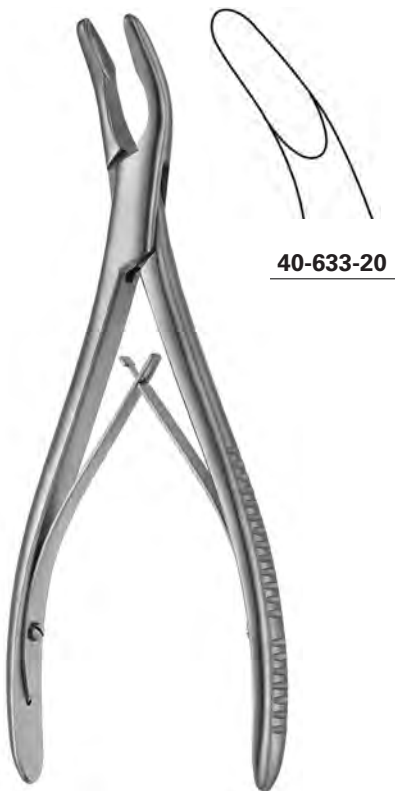
**40-630-20 - 40-631-20** 20,0 cm, 8"



**40-632-20**

**PENNYBACKER**

**40-632-20** 20,5 cm, 8"



**40-633-20**

**OLIVECRONA**

**40-633-20** 20,0 cm, 8"



**40-635-20**

**GULEKE**

**40-635-20** 20,5 cm, 8"



<b>40-640-02</b>	2,0 mm
<b>40-640-03</b>	3,0 mm
<b>40-640-04</b>	4,0 mm
<b>40-640-05</b>	5,0 mm



<b>40-641-02</b>	2,0 mm
<b>40-641-03</b>	3,0 mm
<b>40-641-04</b>	4,0 mm
<b>40-641-05</b>	5,0 mm



**40-641-15**



**BOEHLER**

**40-640-02 - 40-641-05** 15,5 cm, 6 1/8"

**BOEHLER**

**40-641-15** 15,5 cm, 6 1/8"



**40-643-01**



**40-643-02**



**40-645-17**



**KLEINERT-KUTZ**

**40-643-01 - 40-643-02** 14,0 cm, 5 1/2"

**MAYFIELD**

**40-645-17** 18,0 cm, 7"



**40-647-20**

**MARQUARDT**

**40-647-20** 20,0 cm, 8 "



**40-649-18**

**BEYER**

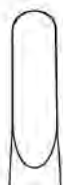
**40-649-18** 18,0 cm, 7 "



**40-651-18**

**ZAUFAL-JANSEN**

**40-651-18** 18,0 cm, 7 "



- 40-652-04** 4,0 mm
- 40-652-05** 5,0 mm
- 40-652-06** 6,0 mm
- 40-652-07** 7,0 mm



- 40-653-04** 4,0 mm
- 40-653-05** 5,0 mm
- 40-653-06** 6,0 mm
- 40-653-07** 7,0 mm

**RUSKIN**

**40-652-04 - 40-653-07** 18,0 cm, 7 "





3,0 mm

**40-657-24**



3,0 mm

**40-657-23**



**40-655-05** 5,0 mm

**40-655-06** 6,0 mm

**40-655-07** 7,0 mm



3,0 mm

**40-656-24**



**ROETTGEN-RUSKIN**

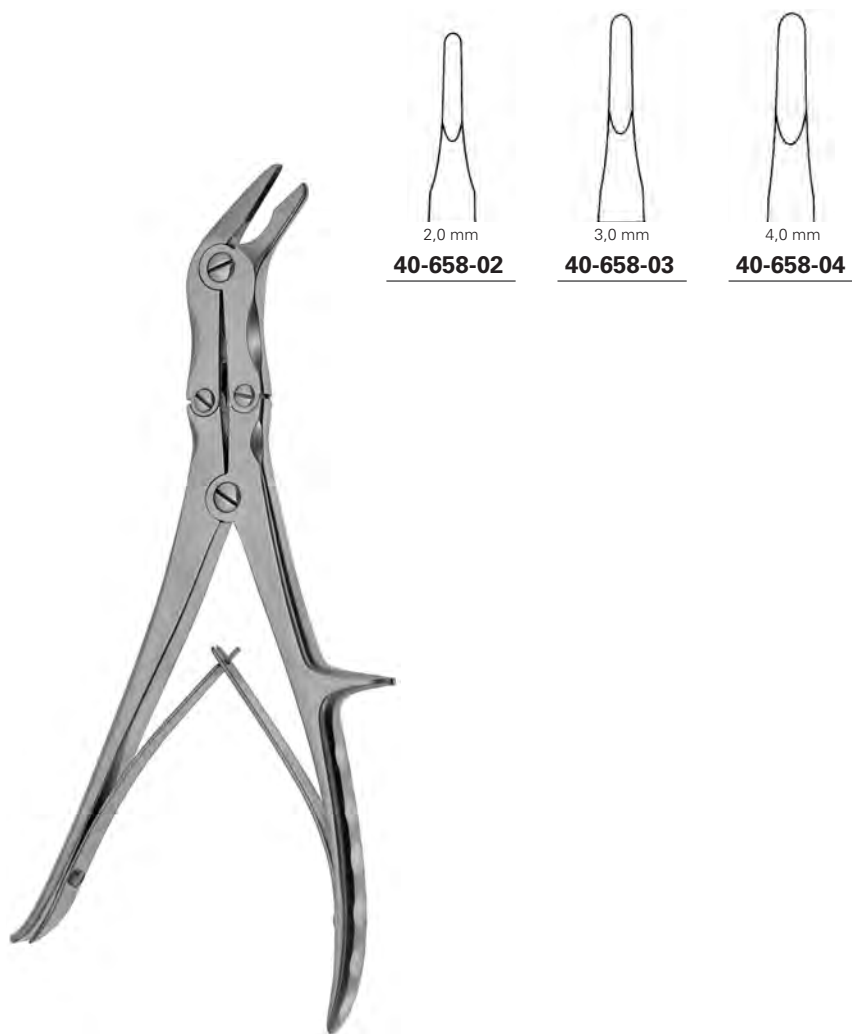
**40-655-05 - 40-655-07** 24,0 cm, 9 1/2"



**SMITH-PETERSEN**

**40-656-24 - 40-657-24** 24,0 cm, 9 1/2"





**ECHLIN**

**40-658-02 - 40-658-04** 23,0 cm, 9"



**40-659-24**

**FRYKHOLM**

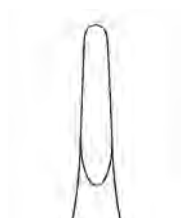
**40-659-24** 24,0 cm, 9 ½"



**40-660-06**

**STILLE**

**40-660-06** 23,0 cm, 9"



<b>40-662-03</b>	3,0 mm
<b>40-662-04</b>	4,0 mm
<b>40-662-05</b>	5,0 mm
<b>40-662-06</b>	6,0 mm
<b>40-662-07</b>	7,0 mm
<b>40-662-08</b>	8,0 mm



<b>40-662-13</b>	3,0 mm
<b>40-662-14</b>	4,0 mm
<b>40-662-15</b>	5,0 mm
<b>40-662-16</b>	6,0 mm
<b>40-662-17</b>	7,0 mm
<b>40-662-18</b>	8,0 mm

### LEKSELL-STILLE

**40-662-03 - 40-662-08** 24,0 cm, 9 1/2"

### LEKSELL

**40-662-13 - 40-662-18** 24,0 cm, 9 1/2"



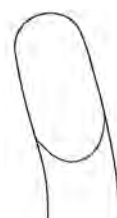
40-663-24

**STILLE-RUSKIN**

40-663-24 23,0 cm, 9"



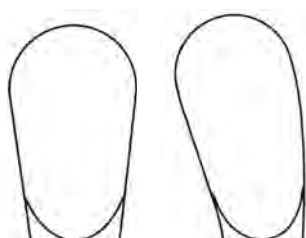
40-664-22



40-665-22

**LUER-STILLE**

40-664-22 - 40-665-22 22,0 cm, 8 3/4"



40-664-23  
40-666-27

40-665-23  
40-667-27



40-669-19



40-669-24

### LUER-STILLE

40-664-23 - 40-665-23 23,0 cm, 9"  
40-666-27 - 40-667-27 27,0 cm, 10<sup>3</sup>/<sub>4</sub>"

### MARKWALDER

40-669-19 19,0 cm, 7 1/2"

### SEMB

40-669-24 24,0 cm, 9 1/2"



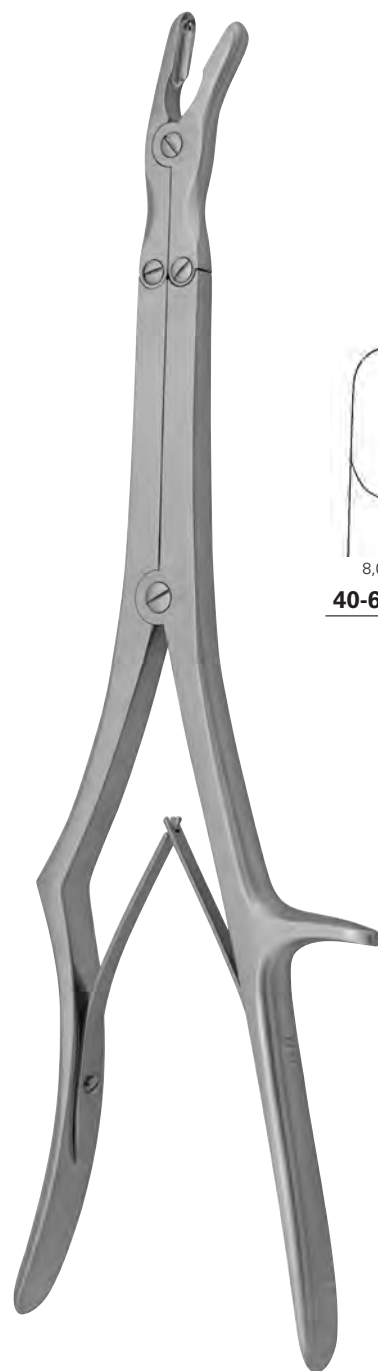
**40-670-01**



**40-670-02**

**SAUERBRUCH-CORYLLOS**

**40-670-01 - 40-670-02** 31,0 cm, 12 ¼"



8,0 mm

**40-672-08**

**SYPERT**

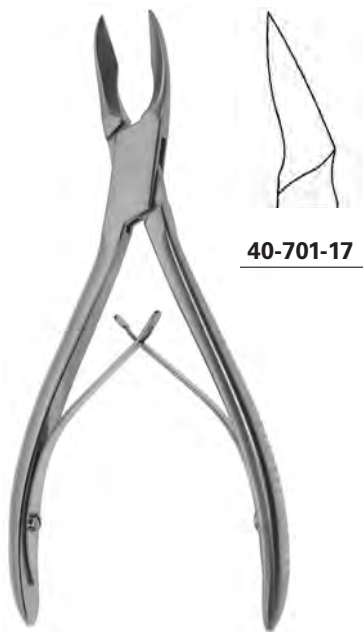
**40-672-08** 36,0 cm, 14 ½"



**40-701-15**

**CLEVELAND**

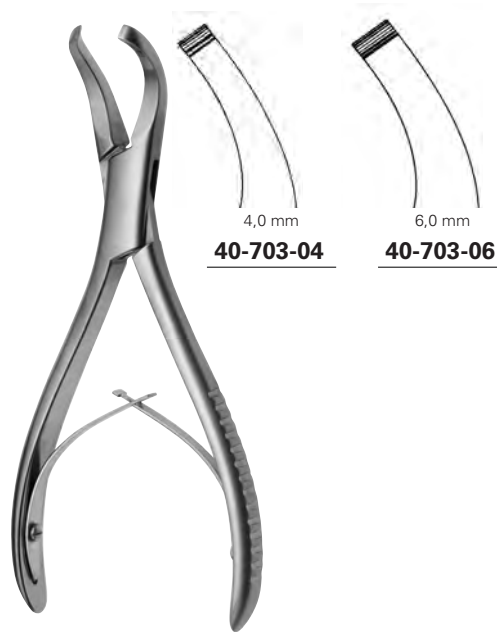
**40-701-15** 15,0 cm, 6 "



**40-701-17**

**CLEVELAND**

**40-701-17** 17,0 cm, 6 3/4 "



**40-703-04**

**40-703-06**

**GARDNER**

**40-703-04 - 40-703-06** 16,0 cm, 6 1/4 "



**40-704-19**

**COTTLE-KAZANJIAN**

**40-704-19** 19,0 cm, 7 1/4 "



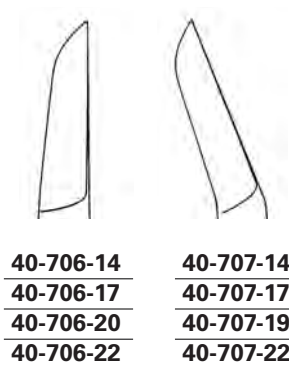
**LISTON**

**40-706-14 - 40-707-14** 14,0 cm, 5 1/2 "

**40-706-17 - 40-707-17** 17,0 cm, 6 3/4 "

**40-706-20 - 40-707-19** 20,0 cm, 8 "

**40-706-22 - 40-707-22** 22,0 cm, 8 3/4 "



**40-706-14**

**40-706-17**

**40-706-20**

**40-706-22**

**40-707-14**

**40-707-17**

**40-707-19**

**40-707-22**



**40-708-15**



**40-709-15**



**40-710-17**



**BOEHLER**

**43-708-15 - 40-709-15** 14,5 cm, 5 ¾"

**40-710-17** 17,0 cm, 6 ¾"



**40-712-19**



**40-713-19**



**40-711-18**



**RUSKIN-LISTON**

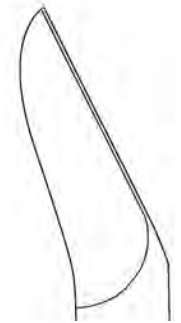
**40-712-19 - 40-713-19** 19,0 cm, 7 ½"

**MC INDOE**

**40-711-18** 17,5 cm, 7"



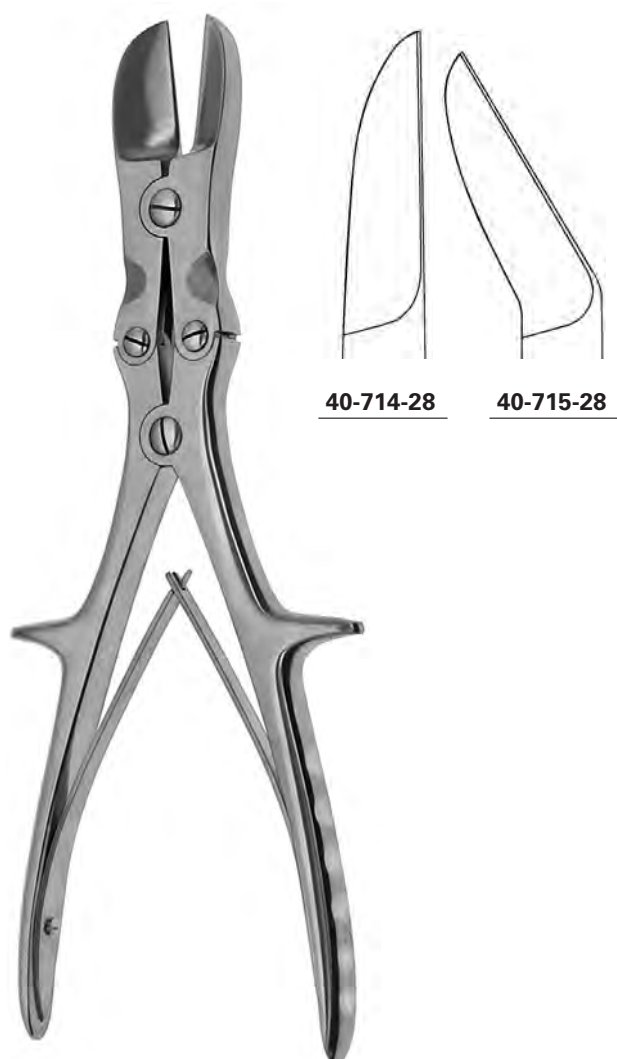
**40-715-24**



**LISTON**

**40-715-24** 24,0 cm, 9 ½"





40-714-28

40-715-28



40-717-27

### LISTON

40-714-28 - 40-715-28 28,0 cm, 11 "

### LISTON-STILLE

40-717-27 27,0 cm, 10<sup>3</sup>/<sub>4</sub> "



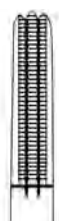
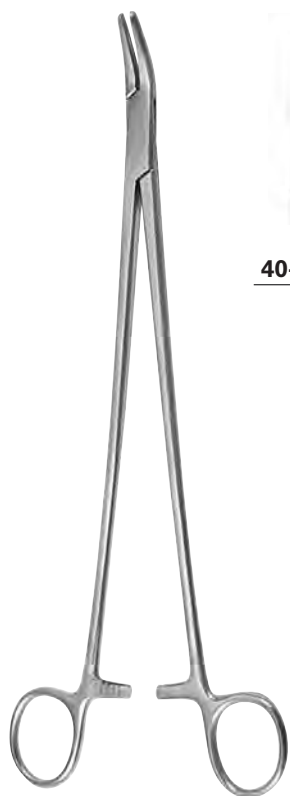
**LISTON-KEY**

**40-719-27** 25,5 cm, 10 "



**SEMB**

**40-721-24** 24,0 cm, 9 ½ "



**40-731-23**



**HERZ**

**40-731-23** 23,0 cm, 9"



**40-733-23**

**JAEGER**

**40-733-23** 23,5 cm, 9 1/4"



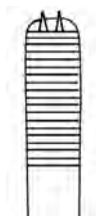
**40-734-20**



**40-735-20**

**BIRCHER**

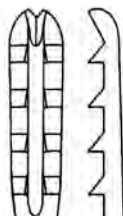
**40-734-20 - 40-735-20** 20,0 cm, 8"



**40-737-20**

**WELLER**

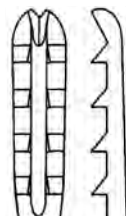
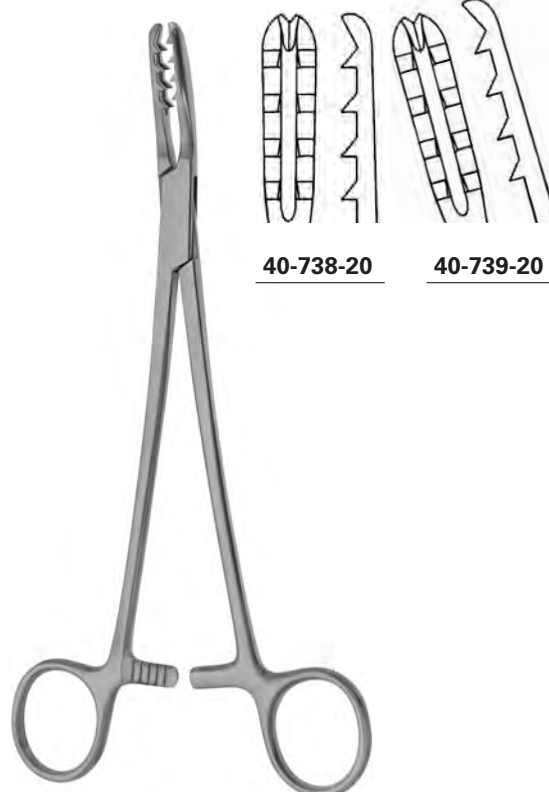
**40-737-20** 20,0 cm, 8"



**40-739-19**

**BIRCHER-GANSKE**

**40-739-19** 20,0 cm, 8"



**40-738-20**



**40-739-20**

**BIRCHER-GANSKE**

**40-738-20 - 40-739-20** 20,0 cm, 8"



**40-739-21**

**BIRCHER-GANSKE**

**40-739-21** 20,0 cm, 8"



**40-740-20**

**MARTIN**

**40-740-20** 20,0 cm, 8"



**40-741-14**

**40-741-14** 14,5 cm, 5 ½"



**40-747-01**

**NEFF**

**40-747-01** 21,5 cm, 8 ½"



**40-747-02**

**NEFF**

**40-747-02** 21,5 cm, 8 ½"



**40-751-01**

**SALENIUS**

**40-751-01** 22,0 cm, 8 ¾"



**40-751-02**

**SALENIUS**

**40-751-02** 22,0 cm, 8 ¾"



**40-754-01**



**BIRCHER**

**40-754-01** 19,0 cm, 7 ½"

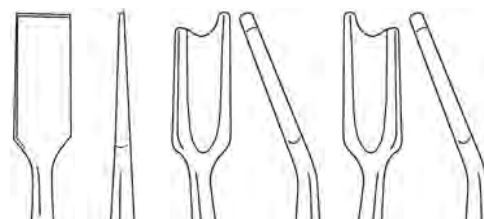


**40-754-02**



**BIRCHER**

**40-754-02** 19,0 cm, 7 ½"



**40-755-01**

**40-755-02**

**40-755-03**



**SMILLIE**

**40-755-01 - 40-755-03** 17,0 cm, 6 ¾"



**40-757-01**



**CANAD. MODELL**

**40-757-01** 20,0 cm, 8"

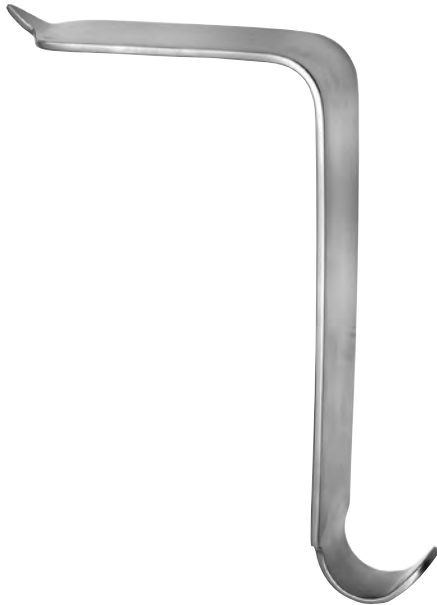


**40-757-02**



**CANAD. MODELL**

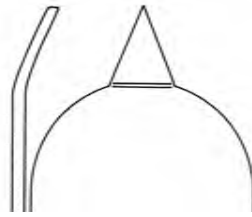
**40-757-02** 20,0 cm, 8"



**40-759-00** 100 x 30 mm  
**40-759-75** 75 x 30 mm

**TAYLOR**

**40-759-00 - 40-759-75** 16,5 cm, 6 ¼"



39,0 x 9,0 mm  
**40-761-22**

**BIRCHER**

**40-761-22** 22,5 cm, 9"

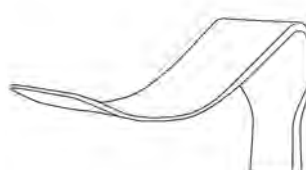


**SMILLIE**

**40-760-01 - 40-760-06** 14,0 cm, 5 ½"



**40-760-01** 32 x 19 mm  
**40-760-02** 48 x 19 mm  
**40-760-03** 57 x 19 mm



**40-760-04** 52 x 13 mm



**40-760-05** 12 x 13 mm

**40-760-06** 13 x 25 mm

**SMILLIE**

**40-760-00** SET

komplett, bestehend aus: 40-760-01 - 40-760-06  
complete, consisting of: 40-760-01 - 40-760-06  
completo, compuesto de: 40-760-01 - 40-760-06  
completo, composto da: 40-760-01 - 40-760-06



40,0 x 4,0 mm  
**40-762-17**

**BLOUNT**

**40-762-17** 17,5 cm, 7 "



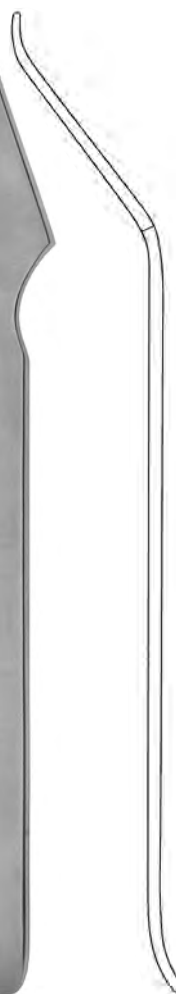
**BLOUNT**

**40-762-26** 26,0 cm, 10 ¼ "



**BLOUNT**

**40-762-27** 26,0 cm, 10 ¼ "




56,0 x 10,0 mm  
**40-763-17**

**40-763-17** 17,0 cm, 6 ¾ "



  
 Ø 4,0 mm  
**40-767-04**

  
 Ø 5,0 mm  
**40-767-05**

**HERZ**

**40-767-04 - 40-767-05** 15,5 cm, 6 "



**40-768-15**  
 4 x 5 Zähne  
 4 x 5 teeth  
 4 x 5 dientes  
 4 x 5 denti

**JACKSON**

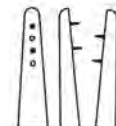
**40-768-15** 15,0 cm, 6 "



**40-770-15**



**40-771-15**



**40-772-12**



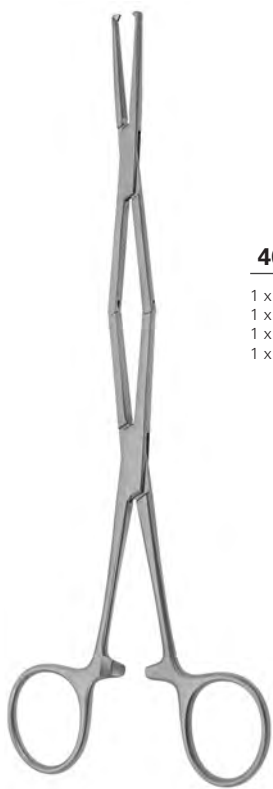
**40-770-15 - 40-771-15** 15,0 cm, 6 "



**40-772-12** 12,0 cm, 4 3/4 "

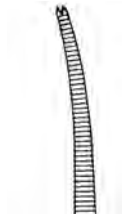


Sehnenflechklemmen, Sehnendurchziehungen  
 Tendon interlacing forceps, Tendon passing forceps  
 Pinzas para entrelazar tendones, Pinzas para pasar tendones  
 Pinze per allacciare tendini, Pinze passa tendine



**40-774-20**

1 x 2 Zähne  
 1 x 2 teeth  
 1 x 2 dientes  
 1 x 2 denti



**40-775-20**

1 x 2 Zähne  
 1 x 2 teeth  
 1 x 2 dientes  
 1 x 2 denti



**CAROLL**

**40-777-11** 11,0 cm, 4 3/8"

**40-774-20 - 40-775-20** 20,5 cm, 8"



**40-776-27** Ø 2,3 mm

flexibel  
 flexible  
 flexibles  
 flessibili

mit Rohrschaft  
 with tubular shaft  
 con vástago tubular  
 con asta tubolare



**JAEGER**

**40-776-27** 27,5 cm, 10 3/4"



**40-778-15**

**40-778-18**

**BRAND**

**40-778-15** 15,0 cm, 6"  
**40-778-18** 18,5 cm, 7 1/4"



**40-779-15**

**40-779-18**

**BRAND**

**40-779-15** 15,0 cm, 6"  
**40-779-18** 18,5 cm, 7 1/4"



**40-780-20**

Ø 2,0 mm  
 1 x 2 Zähne  
 1 x 2 teeth  
 1 x 2 dientes  
 1 x 2 denti

**KLEINERT-KUTZ**

**40-780-20** 20,5 cm, 8"



- 40-788-03** Ø 3,5 mm
- 40-788-04** Ø 4,0 mm
- 40-788-05** Ø 5,0 mm
- 40-788-06** Ø 6,0 mm
- 40-788-09** Ø 9,0 mm

Sehenschäler  
 Tendon stripper  
 Mondador de tendones  
 Enucleatore per tendine



- 40-789-40** Ø 4,0 mm
- 40-789-45** Ø 4,5 mm
- 40-789-55** Ø 5,5 mm

Sehenschäler, flexibler Schaft  
 Tendon stripper, flexible shaft  
 Mondador de tendones, vástago flexible  
 Enucleatore per tendine, gambo malleabile

**BUNNELL**

**40-788-03 - 40-788-09** 15,0 cm, 6"

**40-789-40 - 40-789-55** 23,0 cm, 9"



Ø 5,0 mm

**40-786-23**

biegsam  
 malleable  
 malleable  
 malleabile



Ø 4,0 mm

**40-782-31**

stumpf  
 blunt  
 romo  
 smusso



Ø 3,0 mm

**40-784-29**



Ø 5,5 mm

**40-790-00**

**BUNNELL**

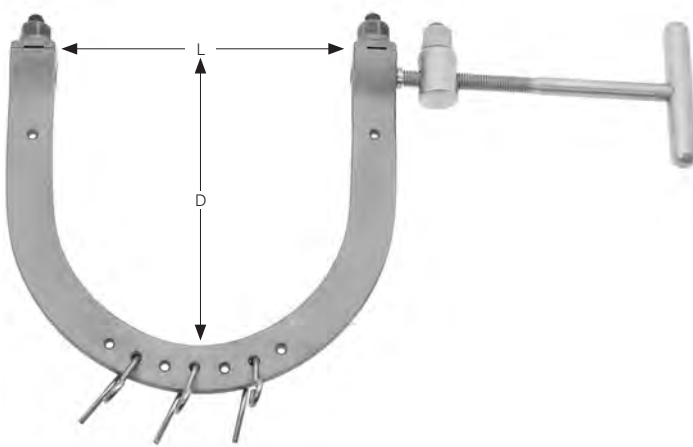
**40-786-23** 23,0 cm, 9"

**FISCHER**

**40-782-31** 31,0 cm, 12 ¼"

**40-784-29** 50,0 cm, 19 ¾"

**40-790-00** 33,5 cm, 13 ¼"



**KIRSCHNER**

<b>40-801-00</b>	60 x 60 mm
<b>40-801-01</b>	95 x 70 mm
<b>40-801-02</b>	95 x 110 mm
<b>40-801-03</b>	105 x 100 mm
<b>40-801-04</b>	120 x 120 mm
<b>40-801-05</b>	135 x 130 mm
<b>40-801-06</b>	155 x 155 mm
<b>40-801-07</b>	200 x 155 mm



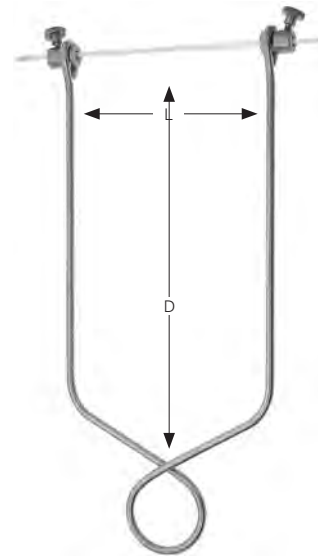
**KIRSCHNER**

<b>40-802-01</b>	40 - 140 mm
<b>40-802-03</b>	60 - 220 mm



**KIRSCHNER**

<b>40-803-01</b>	0 - 130 mm
<b>40-803-02</b>	0 - 185 mm
<b>40-803-03</b>	0 - 220 mm



**KIRSCHNER**

<b>40-804-01</b>	90 x 160 mm
<b>40-804-02</b>	110 x 210 mm
<b>40-804-03</b>	150 x 210 mm



Spannschlüssel für 40-801-00 – 07  
Wrench for 40-801-00 – 07  
Tensor de taladros para 40-801-00 – 07  
Chiave per mandrino per 40-801-00 – 07



**40-805-00**

Spannschlüssel  
Wrench  
Tensor de taladros  
Chiave per mandrino



**40-806-00** SW 14 | 17

Zughaken, groß  
Traction hook, large  
Gancho de tracción, grande  
Ganci di trazione, grande



**40-807-00**

Zughaken, klein  
Traction hook, small  
Gancho de tracción, pequeño  
Ganci di trazione, piccola



**40-808-00**

Fixierscheiben, paar  
Fixation discs, pair  
Discos fijadores, par  
Dischi fissaggio, paio



**40-809-00**

Begrenzungsplatte  
Fixation disc  
Disco fijador  
Disco fissaggio



**40-810-00**



Fig. 1

**40-811-01**

Drahtgeflecht, klein  
Wire mesh, small  
Malla de alambre, pequeño  
Maglia metallica, piccola

Fig. 2

**40-811-02**

Drahtgeflecht, mittel  
Wire mesh, medium  
Malla de alambre, mediano  
Maglia metallica, mezzo

Fig. 3

**40-811-03**

Drahtgeflecht, groß  
Wire mesh, large  
Malla de alambre, grande  
Maglia metallica, grande

**40-811-01 - 40-811-03** 23,0 cm, 9"

Handbohrfutter und Spannschlüssel  
40-816-97, längsdurchbohrt Ø 4,5 mm  
Drilling chuck and key 40-816-97,  
cannulated Ø 4,5 mm  
Mandril de tres mordazas con clave  
40-816-97, barrenado oblongo Ø 4,5 mm  
Trapano con mandrino e chiave  
40-816-97, tubolare Ø 4,5 mm

Handbohrfutter und Spannschlüssel  
40-816-99, längsdurchbohrt Ø 6,0 mm  
Drilling chuck and key 40-816-99,  
cannulated Ø 6,0 mm  
Mandril de tres mordazas con clave  
40-816-99, barrenado oblongo Ø 6,0 mm  
Trapano con mandrino e chiave  
40-816-99, tubolare Ø 6,0 mm

Ø 0,8 - 1,6 mm



**VICKERS**

**40-812-00** 14,0 cm, 5 1/2"



**40-813-00** Ø 0,5 - 7,0 mm



**40-816-00** Ø 0,5 - 7,0 mm

AO Dreibackenspannfutter und  
Spannschlüssel 40-816-99  
AO Three jaw chuck and key 40-816-99  
AO Tres de sujeción del portabrocas con  
clave 40-816-99  
AO Mandrino a tre ganasce e chiave  
40-816-98

AO Dreibackenspannfutter und  
Spannschlüssel 40-918-99  
AO Three jaw chuck and key 40-918-99  
AO Tres de sujeción del portabrocas con  
clave 40-918-99  
AO Mandrino a tre ganasce e chiave  
40-918-98

AO Dreibackenspannfutter und  
Spannschlüssel 40-816-99  
AO Three jaw chuck and key 40-816-99  
AO Tres de sujeción del portabrocas con  
clave 40-816-99  
AO Mandrino a tre ganasce e chiave  
40-816-98



**40-817-00** Ø 0,5 - 7,0 mm



**40-817-01** Ø 0,0 - 4,0 mm



**40-818-00** Ø 0,5 - 7,0 mm

Bohrhandgriffe, Cerlage Draht  
 Drill Handles, Bone wires  
 Perforadores de mano, Hilos de cerclaje  
 Perforatori a mano, Filo per ossa



T - Handbohrfutter, längsdurchbohrt Ø 6,0 mm  
 T - drilling chuck, cannulated Ø 6,0 mm  
 T - mandril de tres mordazas, barrenado oblongo Ø 6,0 mm  
 T - trapano con mandrino, tubolare Ø 6,0 mm

T - Handbohrfutter, verriegelbar, längsdurchbohrt Ø 6,0 mm  
 T - drilling chuck, lockable, cannulated Ø 6,0 mm  
 T - mandril de tres mordazas, bloqueado, barrenado oblongo Ø 6,0 mm  
 T - trapano con mandrino, bloccato, tubolare Ø 6,0 mm

T - Handbohrfutter, verriegelbar, längsdurchbohrt Ø 6,0 mm  
 T - drilling chuck, lockable, cannulated Ø 6,0 mm  
 T - mandril de tres mordazas, bloqueado, barrenado oblongo Ø 6,0 mm  
 T - trapano con mandrino, bloccato, tubolare Ø 6,0 mm



**40-819-00** Ø 1,0-6,0 mm



**40-820-00** Ø 1,0-6,0 mm



**40-820-10** Ø 1,0-6,0 mm



Cerclage Draht, weich, 10m  
 Bone wire, soft, 10 m  
 Hilos de cerclaje, blando, 10 m  
 Filo per ossa, malleabile, 10 m



Cerclage Draht, weich, 10m  
 Bone wire, soft, 10 m  
 Hilos de cerclaje, blando, 10 m  
 Filo per ossa, malleabile, 10 m



Durchmesser  
 Diameter  
 Diámetro  
 Diametro

Ø 0,2 mm	<b>40-821-02</b>
Ø 0,3 mm	<b>40-821-03</b>
Ø 0,4 mm	<b>40-821-04</b>
Ø 0,5 mm	<b>40-821-05</b>
Ø 0,6 mm	<b>40-821-06</b>
Ø 0,7 mm	<b>40-821-07</b>
Ø 0,8 mm	<b>40-821-08</b>
Ø 0,9 mm	<b>40-821-09</b>
Ø 1,0 mm	<b>40-821-10</b>
Ø 1,2 mm	<b>40-821-12</b>
Ø 1,5 mm	<b>40-821-15</b>
Ø 1,8 mm	<b>40-821-18</b>
Ø 2,0 mm	<b>40-821-20</b>

Durchmesser  
 Diameter  
 Diámetro  
 Diametro

Ø 0,2 mm	
Ø 0,3 mm	
Ø 0,4 mm	
Ø 0,5 mm	
Ø 0,6 mm	
Ø 0,7 mm	
Ø 0,8 mm	<b>40-821-08 T</b>
Ø 0,9 mm	
Ø 1,0 mm	<b>40-821-10 T</b>
Ø 1,2 mm	<b>40-821-12 T</b>
Ø 1,5 mm	<b>40-821-15 T</b>
Ø 1,8 mm	
Ø 2,0 mm	



**LOUTE**

**40-822-22** 21,5 cm, 8 1/2"



**DEMEL**

**40-824-27** 27,0 cm, 10 3/4"

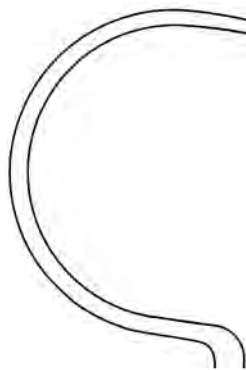


**40-824-09** 9,0 cm, 3 1/2"

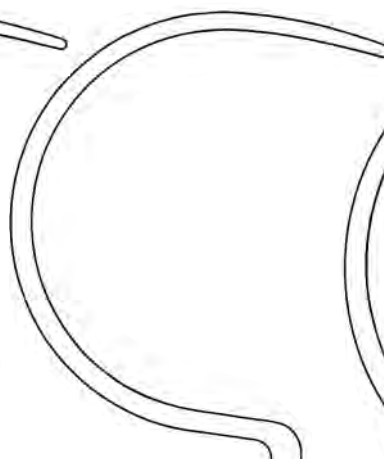


**DEMEL**

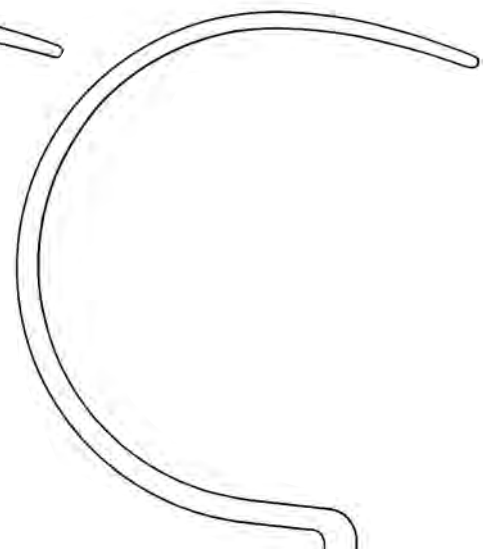
**40-825-01** 27,5 cm, 10 3/4"  
**40-825-02** 28,5 cm, 11 1/4"  
**40-825-03** 30,5 cm, 12"



**40-825-01**



**40-825-02**

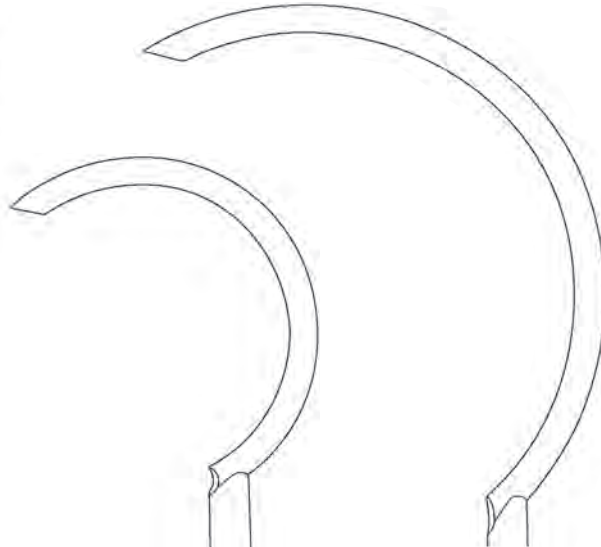


**40-825-03**





**40-826-01**



**40-826-02**



**40-827-01**

**40-826-01** 24,0 cm, 9 1/2 "  
**40-826-02** 27,0 cm, 10 3/4 "

**40-827-01** 22,5 cm, 9 "



**40-828-20**



**BAUMGARTNER**

**40-828-20** 20,0 cm, 8 "



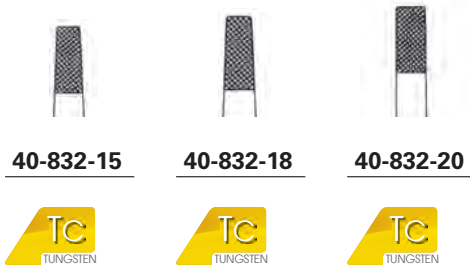
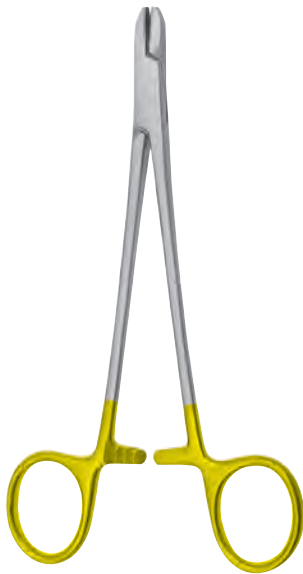
**40-830-15**



**40-830-18**



**40-830-15** 15,0 cm, 6 "  
**40-830-18** 18,0 cm, 7 "



**40-832-15**

**40-832-18**

**40-832-20**



<b>40-832-15</b>	15,0 cm, 6"
<b>40-832-18</b>	18,0 cm, 7"
<b>40-832-20</b>	20,0 cm, 8"



**40-834-13**  
**40-834-15**  
**40-834-18**



<b>40-834-13</b>	15,0 cm, 5 1/8"
<b>40-834-15</b>	15,0 cm, 6"
<b>40-834-18</b>	18,0 cm, 7"



**40-836-18**  
**40-836-20**



<b>40-836-18</b>	18,5 cm, 7 1/4"
<b>40-836-20</b>	20,0 cm, 8"

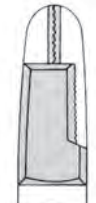


**40-838-16**



**CORWIN**

<b>40-838-16</b>	16,0 cm, 6 1/4"
------------------	-----------------



**40-840-17**

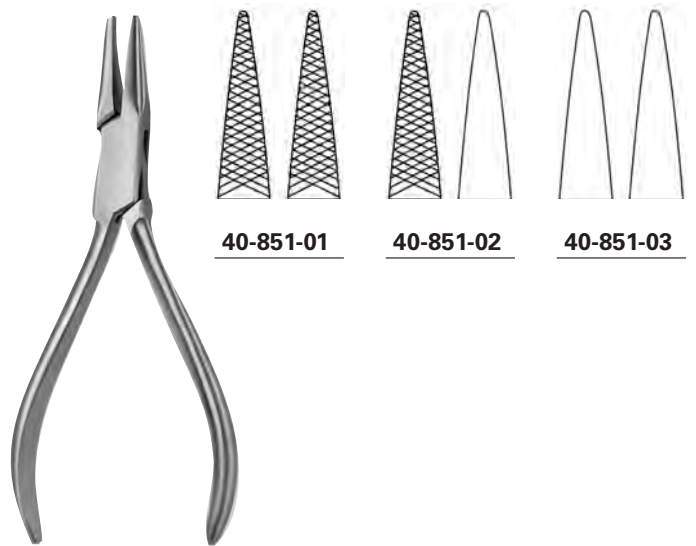


<b>40-840-17</b>	17,0 cm, 6 3/4"
------------------	-----------------



**40-850-14**

**40-850-14** 14,0 cm, 5 ½"

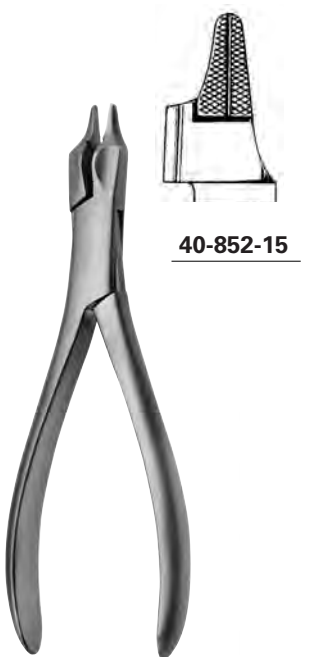


**40-851-01**

**40-851-02**

**40-851-03**

**40-851-01 - 40-851-03** 14,0 cm, 5 ½"



**40-852-15**

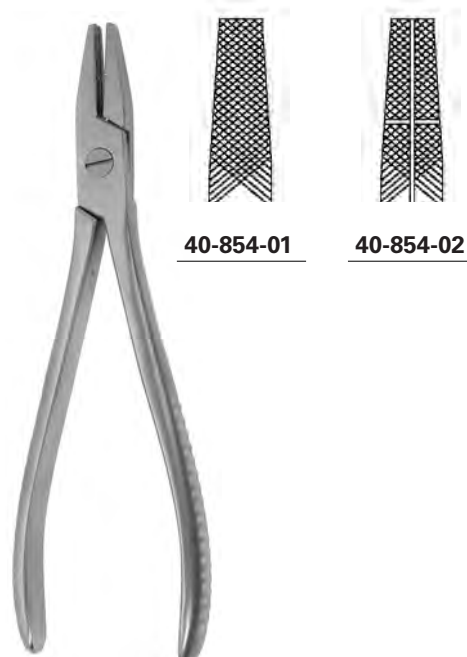
**40-852-15** 15,0 cm, 6"



**40-852-16**

**40-852-16** 16,0 cm, 6 ¼"

**HACKSTOCK**



**40-854-01**

**40-854-02**

**40-854-01 - 40-854-02** 17,0 cm, 6 ¾"



**40-854-03**

**40-854-03** 19,0 cm, 7 1/2"



**40-856-17**

**40-856-17** 17,0 cm, 6 3/4"



**40-858-17** 18,0 cm, 8"



**40-858-18** 18,0 cm, 7"

**40-858-20** 20,0 cm, 8"

**40-858-24** 24,0 cm, 9 1/2"



**40-860-13** 13,0 cm, 5 1/8"

**40-860-18** 18,0 cm, 8"



**40-862-01**  
**40-862-11**



**40-862-02**



**40-862-03**



**40-864-18**

**40-862-01** 14,5 cm, 5 ¾"  
**40-862-02 - 40-862-11** 18,0 cm, 7"

**40-864-18** 18,0 cm, 7"



**40-863-01**



**40-863-02**



**40-863-03**



**40-863-01 - 40-863-03** 18,0 cm, 7"



**40-865-00** < Ø 1,8 mm



1,0 mm 1,5 mm

**40-868-14**



**40-868-14** 14,0 cm, 5 ½"



1,0 mm 1,5 mm

**40-870-15**



**40-870-15** 15,0 cm, 6"



1,2 mm 1,5 mm

**40-872-16**



**40-872-16** 16,0 cm, 6 ¼"



1,7 mm 2,0 mm

**40-873-16**

**40-873-18**



**40-873-16** 16,0 cm, 6 ¼"

**40-873-18** 18,0 cm, 7"



2,2 mm 3,0 mm

**40-873-22**



**40-873-22** 22,0 cm, 8 ¾"



1,5 mm 2,0 mm

**40-874-17**



**REILL**

**40-874-17** 17,5 cm, 7"



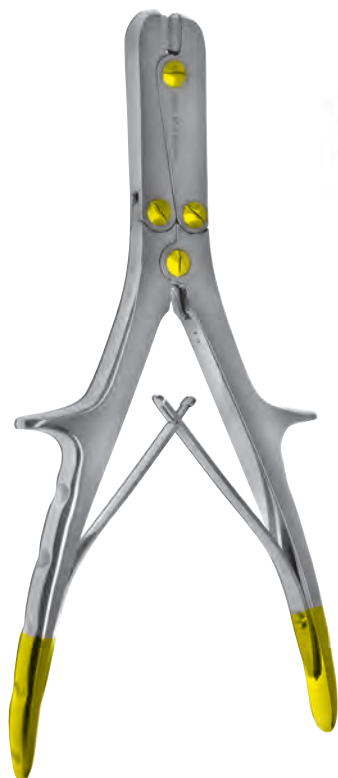
Drahtkneifzangen  
Wire cutting forceps  
Alicates corta-alambres  
Tenaglie tagliafili

max. Ø

harte Drähte  
hard wires  
alambres duros  
fili duri

max. Ø

weiche Drähte  
soft wires  
alambres blandos  
fili molli



3,0 mm 3,0 mm

**40-873-25**



Kunststoffbacken halten den Draht nach dem Durchtrennen in der Zange fest.

Plastic inserts hold wire piece after being cut.

Mordazas de plástico retienen el alambre después del corte.

Le guance di plastica sostengono il filo nel morso della pinza dopo il taglio.

**40-873-25** 25,0 cm, 9 3/4 "



2,2 mm

**40-875-18**



**40-875-18** 18,0 cm, 7 "



3,0 mm

**40-875-23**



**40-875-23** 23,0 cm, 9 "



4,0 mm

**40-875-28**



**40-875-28** 28,0 cm, 11 "

Ersatzteilset  
Spare part set  
Juego de pieza de repuesto  
Set di pezzo di ricambio



**40-875-88** => 40-875-18

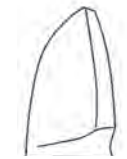
**40-875-89** => 40-875-23

**40-875-90** => 40-875-28

Ersatzteilset für 40-875-18 - 28  
Spare part set for 40-875-18 - 28  
Juego de pieza de repuesto 40-875-18 - 28  
Set di pezzo di ricambio 40-875-18 - 28



**40-875-91** SET



1,8 mm 2,3 mm  
**40-876-17**



2,2 mm 3,0 mm  
**40-876-23**



1,0 mm  
**40-877-16**



1,6 mm 2,4 mm  
**40-878-18**

längsdurchbohrt  
annuallat  
barrenado oblongo  
tubolare

**40-876-17** 17,0 cm, 6 3/4"  
**40-876-23** 23,5 cm, 9 1/4"

**40-877-16** 16,0 cm, 6 1/4"

**40-878-18** 18,0 cm, 7"



1,0 mm 1,5 mm  
**40-880-14**



1,5 mm 2,0 mm  
**40-882-14**



2,0 mm 2,2 mm  
**40-884-16**

**40-880-14** 14,5 cm, 5 3/4"

**40-882-14** 14,5 cm, 5 3/4"

**40-884-16** 16,0 cm, 6 1/4"



Drahtkneifzangen  
Wire cutting forceps  
Alicates corta-alambres  
Tenaglie tagliafili

max. Ø

harte Drähte  
hard wires  
alambres duros  
fili duri

max. Ø

weiche Drähte  
soft wires  
alambres blandos  
fili molli



1,5 mm 2,0 mm

**40-886-18**



1,6 mm

**40-887-18**



Ersatzteilset  
Spare part set  
Juego de pieza de repuesto  
Set di pezzo di ricambio



**40-886-18** 18,0 cm, 7 "

**40-887-18** 18,0 cm, 7 "

**40-887-90** => 40-887-18



2,0 mm 3,0 mm

**40-888-22**



3,0 mm 3,0 mm

**40-889-02**



Ersatzteilset  
Spare part set  
Juego de pieza de repuesto  
Set di pezzo di ricambio



**40-888-22** 22,0 cm, 8 3/4 "

**40-889-02** 17,0 cm, 6 3/4 "

**40-889-98** => 40-889-02

Ersatzteilset  
Spare part set  
Juego de pieza de repuesto  
Set di pezzo di ricambio



**40-889-99** => 40-889-02



**40-890-23** 23,0 cm, 9"



6,0 mm  
**40-890-47**  
**40-890-54**



6,0 mm  
**40-890-58**



6,0 mm  
**40-890-48**



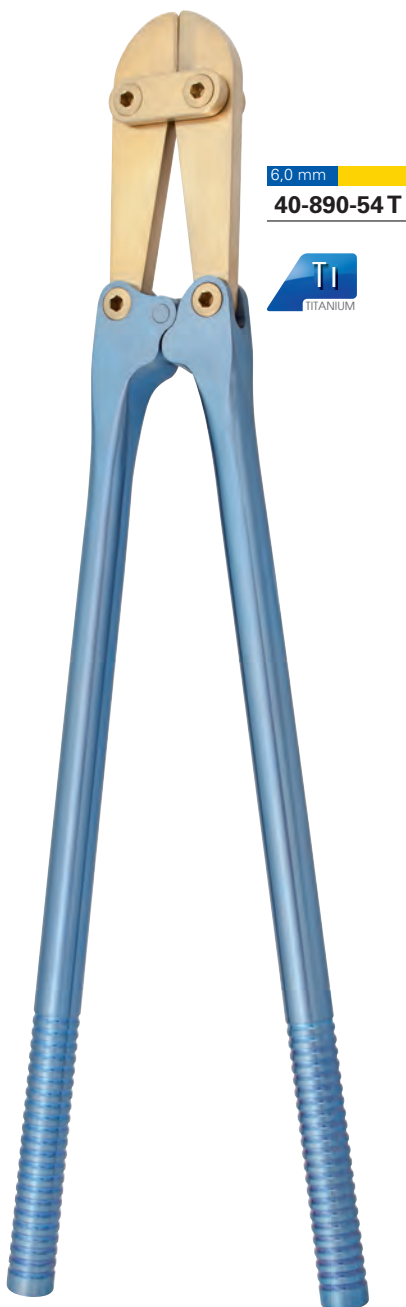
Griffe abnehmbar  
Removable handles  
Mangos desmontables  
Manici smontabili

6,0 mm  
**40-890-57**

Griffe abnehmbar  
Removable handles  
Mangos desmontables  
Manici smontabili

**40-890-47** 47,0 cm, 18 1/4"  
**40-890-54** 56,0 cm, 22"  
**40-890-58** 58,0 cm, 23"

**40-890-48** 48,0 cm, 18 3/4"  
**40-890-57** 57,0 cm, 22 1/2"



6,0 mm  
**40-890-54 T**

**Ti**  
TITANIUM



2,5 mm 3,2 mm  
**40-891-26**

3,2 mm 4,0 mm  
**40-891-38**



3,2 mm 4,7 mm  
**40-891-39**

**Tc**  
TUNGSTEN

**40-890-54 T** 54,0 cm, 21 1/2"

**40-891-26** 26,0 cm, 10 3/8"  
**40-891-38** 38,0 cm, 15"

**40-891-39** 38,0 cm, 15"

max. Ø

harte Drähte  
 hard wires  
 alambres duros  
 fili duri

max. Ø

weiche Drähte  
 soft wires  
 alambres blandos  
 fili molli

3,0 mm

**40-892-32**



< Ø 3,0 mm



**WAGNER**

**40-896-30** 30,0 cm, 11 3/4"

< Ø 3,0 mm



**WAGNER**

**40-896-30 P** 30,0 cm, 11 3/4"

< Ø 2,7 mm



**40-894-12** 12,0 cm, 4 3/4"

**Pf**  
FERROZELL

**Pp**  
PROPYLUX®



komplett, mit einem Satz Bohrer 40-910-01  
complete, with a set of drills 40-910-01  
completo, con un juego de brocas 40-910-01  
completo, con una serie di punte 40-910-01



3,2 x 70 mm 3,2 x 70 mm 3,2 x 90 mm



### MOORE

**40-910-00** 27,5 cm, 10 7/8"

**40-910-01** SET

komplett, mit einerm Satz Bohrer 40-911-01 - 03  
complete, with a set of drills 40-911-01 - 03  
completo, con un juego de brocas 40-911-01 - 03  
completo, con una serie di punte 40-911-01 - 03



Ø 3,5 mm

**40-911-03**



Ø 2,5 mm

**40-911-01**



Ø 3,0 mm

**40-911-02**

### STILLE-SHERMAN

**40-911-00** 25,0 cm, 9 7/8"

komplett, mit einem Satz Bohrer 40-912-10 - 18  
complete, with a set of drills 40-912-10 - 18  
completo, con un juego de brocas 40-912-10 - 18  
completo, con una serie di punte 40-912-10 - 18



Handbohrapparat  
Hand drill  
Perforador de mano  
Trapano a mano per ossa



Ø 2,5 mm

**40-912-10**



Ø 3,0 mm

**40-912-11**



Ø 3,5 mm

**40-912-12**



Ø 4,0 mm

**40-912-13**

**40-912-01**



Ø 10,0 mm

**40-912-14**



Ø 5,0 mm

**40-912-15**



Ø 8,0 mm

**40-912-16**



Ø 12,0 mm

**40-912-17**



Ø 16,0 mm

**40-912-18**

### STILLE

**40-912-00** 20,0 cm, 8"

komplett, mit einem Satz Bohrer 40-916-01 - 04 | 09  
complete, with a set of drills 40-916-01 - 04 | 09  
completo, con un juego de brocas 40-916-01 - 04 | 09  
completo, con una serie di punte 40-916-01 - 04 | 09

Verlängerungsstück  
Extension Piece  
Pieza de prolongación  
Giunto di prolungamento



**HUDSON**

**40-916-00** 28,0 cm, 11 "

Handbohrapparat  
Hand drill  
Perforador de mano  
Trapano a mano per ossa

**40-916-10**



**40-916-09**



Ø 9,0 mm

**40-916-01**



Ø 14,0 mm

**40-916-02**



Ø 16,0 mm

**40-916-03**



Ø 22,0 mm

**40-916-04**



Ø 13,0 mm

**40-916-05**



Ø 2,4 mm

**40-916-06**



Ø 13,0 mm

**40-916-07**



Ø 15,0 mm

**40-916-08**

Handbohrapparat und Spannschlüssel 40-918-99  
Hand drill and key 40-918-99  
Perforador de mano con llave 40-918-99  
Trapano a mano per ossa e chiave 40-918-99



**BUNNELL**

**40-918-00**

Handbohrapparat und Spannschlüssel 40-816-99  
Hand drill and key 40-816-99  
Perforador de mano con llave 40-816-99  
Trapano a mano per ossa e chiave 40-816-99

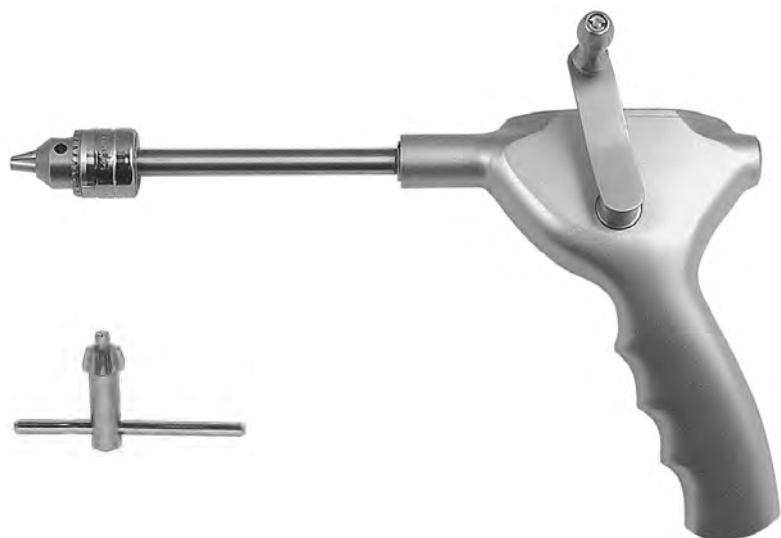


**RALK**

**40-919-00**



Handbohrapparat und Spannschlüssel 40-816-99  
Hand drill and key 40-816-99  
Perforador de mano con llave 40-816-99  
Trapano a mano per ossa e chiave 40-816-99



## RALK

**40-919-01**

Handbohrapparat und Spannschlüssel 40-816-98  
Hand drill and key 40-816-98  
Perforador de mano con llave 40-816-98  
Trapano a mano per ossa e chiave 40-816-98



**40-920-00**





42/43/44

Osteosythese  
Osteosynthesis  
Osteosíntesis  
Osteosintesi





47

Hand- und Fuß Chirurgie

Hand and foot Surgery

Cirugía de mano y pie

Chirurgia della mano e piede





**47-001-13**

**MANNERFELT**

**47-001-13** 13,5 cm, 5 1/4"



**47-001-15**

**MANNERFELT**

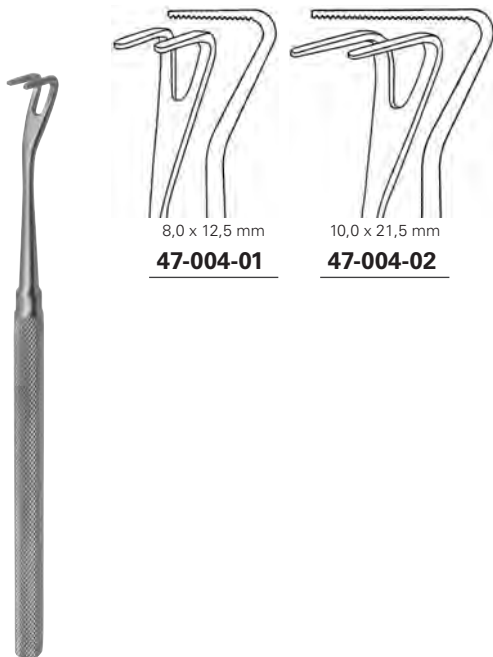
**47-001-15** 15,5 cm, 6 1/8"



3,5 x 12,0 mm  
**47-003-15**

**MANNERFELT**

**47-003-15** 15,5 cm, 6 1/8"

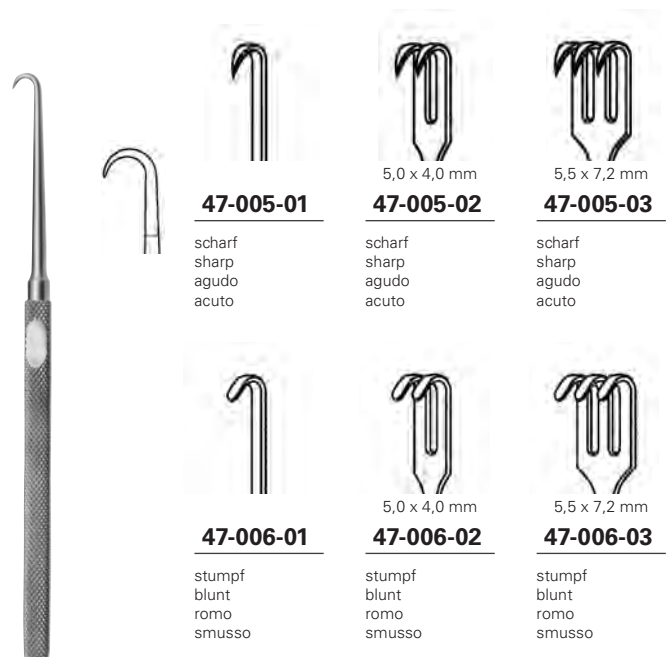


8,0 x 12,5 mm  
**47-004-01**

10,0 x 21,5 mm  
**47-004-02**

**MANNERFELT**

**47-004-01 - 47-004-02** 15,5 cm, 6 1/8"



**47-005-01**

scharf  
sharp  
agudo  
acuto

5,0 x 4,0 mm  
**47-005-02**

scharf  
sharp  
agudo  
acuto

5,5 x 7,2 mm  
**47-005-03**

scharf  
sharp  
agudo  
acuto

**47-006-01**

stumpf  
blunt  
romo  
smusso

5,0 x 4,0 mm  
**47-006-02**

stumpf  
blunt  
romo  
smusso

5,5 x 7,2 mm  
**47-006-03**

stumpf  
blunt  
romo  
smusso

**MANNERFELT**

**47-005-01 - 47-006-03** 15,5 cm, 6 1/8"



**MANNERFELT**

**47-007-01 - 47-008-03** 15,5 cm, 6 1/8"

**MANNERFELT**

**47-009-03** 15,5 cm, 6 1/8"

**MANNERFELT**

**47-010-01** 15,5 cm, 6 1/8"



**MANNERFELT**

**47-012-15 - 47-012-30** 15,5 cm, 6 1/8"

**MANNERFELT**

**47-014-12 - 47-014-16** 15,5 cm, 6 1/8"

**MANNERFELT**

**47-015-12** 15,5 cm, 6 1/8"



**47-017-02**



**47-018-02**



4,0 mm

**47-020-04**



7,0 mm

**47-020-07**



9,0 mm

**47-020-09**

**MANNERFELT**

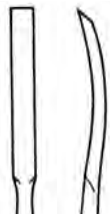
**47-017-02** 16,0 cm, 6 ¼"

**MANNERFELT**

**47-018-02** 16,0 cm, 6 ¼"

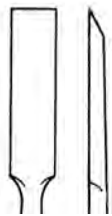
**MANNERFELT**

**47-020-04 - 47-020-09** 15,5 cm, 6 ⅛"



3,0 mm

**47-021-03**



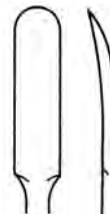
6,0 mm

**47-021-05**



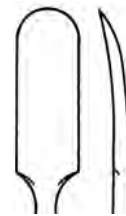
6,0 mm

**47-021-06**



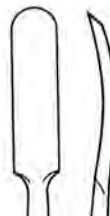
6,0 mm

**47-022-06**



8,0 mm

**47-022-08**



6,0 mm

**47-023-04**



5,0 mm

**47-023-05**



4,0 mm

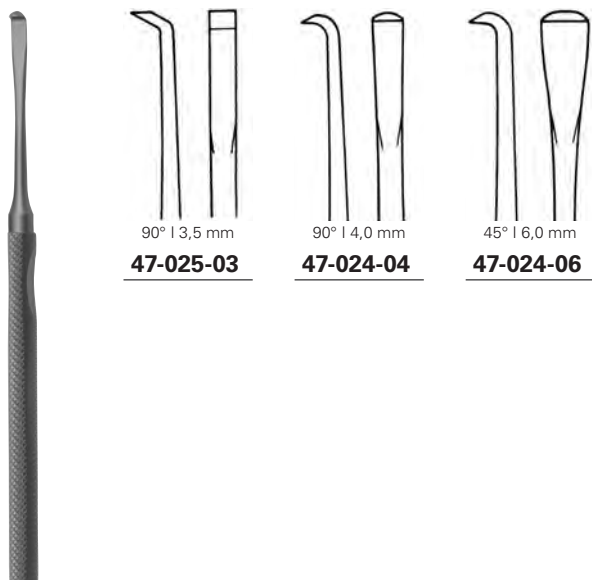
**47-023-06**

**MANNERFELT**

**47-021-03 - 47-021-06** 15,5 cm, 6 ⅛"

**MANNERFELT**

**47-022-06 - 47-023-06** 15,5 cm, 6 ⅛"



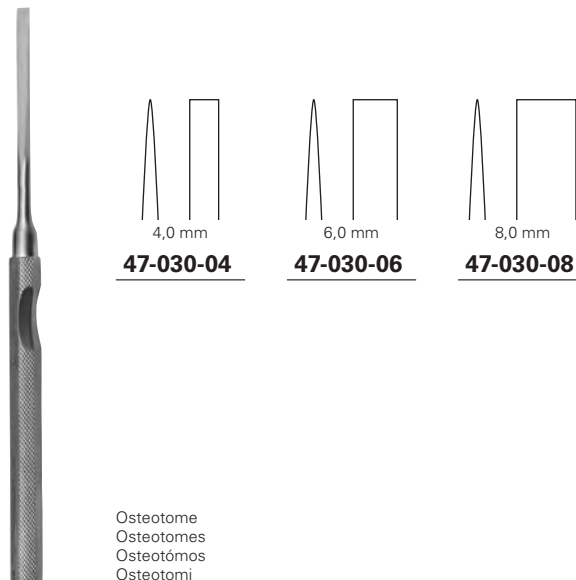
90° | 3,5 mm  
**47-025-03**

90° | 4,0 mm  
**47-024-04**

45° | 6,0 mm  
**47-024-06**

### MANNERFELT

**47-024-04 - 27-025-03** 15,5 cm, 6 1/8 "



4,0 mm  
**47-030-04**

6,0 mm  
**47-030-06**

8,0 mm  
**47-030-08**

Osteotome  
 Osteotomes  
 Osteótomos  
 Osteotomi

### MANNERFELT

**47-030-04 - 47-030-08** 15,5 cm, 6 1/8 "



3,0 mm  
**47-032-03**

Hohlmeißel  
 Gouge  
 Gubias  
 Sgorbie

### MANNERFELT

**47-032-03** 15,5 cm, 6 1/8 "



Kompressorium  
 Tourniquet  
 Compresor  
 Compressorio

### FELDHEIM

**47-210-00** 10,0 cm, 4 "



**47-212-00** 37,0 cm, 14 1/2"

für Erwachsene  
for adults  
para adultos  
per adulti

**47-214-00** 24,5 cm, 9 2/3"

für Kinder  
for children  
para niños  
per bambini

Bleihände: Durch Umbiegen der Lappen werden Hand und Finger in Operationslage festgehalten und durch das Gewicht der Bleihand zusätzlich immobilisiert.

Lead hands: Hand and fingers are secured by bending the lateral fixation process and further fixed by weight of lead hand.

Manos de plomo: Doblando los lóbulos se sujeta la mano y los dedos en posición para operar, y se queda también inmóvil por el peso de la mano de plomo.

Mano di piombo: Legando i lobi, la mano e le dita si assestano in posizione da poter operare grazie al peso della mano di piombo.

Gummiring  
Rubber ring  
Anillos de goma  
Anelli di gomma



**47-212-99** Ø 30,0 mm



**VICKERS**

**47-216-00** 25,0 cm, 10"

Handhalter: Schnelles und sicheres Fixieren von Hand, Daumen und Fingern. Finger können seitlich nicht entweichen. Mehrfache Halterungen für Gummiband-Retraktoren.

Hand restrainer: Rapid application and release hand, thumb and individual fingers. Digits cannot escape sideways. Multipoint rubber band anchorages for varied postures.

Sujetador de mano: Aplicación rápida y segura de la mano, del pulgar y de los dedos. Los dedos no se pueden escapar lateralmente. Fijadores múltiples para retractores de cintas elásticas.

Supporto-mano: Di rapida applicazione e di sollievo per la mano, pollice e dita individuali. Le dita non possono andare lateralmente munito di varie fasce di gomma per l'ancoraggio in diverse posizioni.





Hand- und Karpaltunnel-Wundspreizer,  
mit Mittelvalve 10 x 18 mm 47-224-01  
Hand and carpal tunnel retractor,  
with central valve 10 x 18 mm 47-224-01  
Separador de mano y túnel de carpo,  
con valva central 10 x 18 mm 47-224-01  
Divaricatore per la mano con condotto  
carpale, con valva centrale 10 x 18 mm  
47-224-01



**VICKERS**

**47-221-00** 7,5 cm, 3"

Hand- und Unterarm-Wundspreizer,  
mit Mittelvalve 10 x 18 mm 47-224-01  
Deep hand and forearm retractor,  
with central valve 10 x 18 mm 47-224-01  
Separador profundo para mano y antebra-  
zo, con valva central 10 x 18 mm 47-224-01  
Divaricatore per la mano e l'avambraccio,  
con valva centrale 10 x 18 mm 47-224-01



**VICKERS**

**47-222-00** 9,0 cm, 3 1/8"

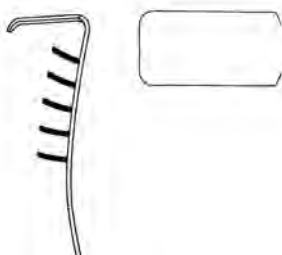
Schnellender Finger- und Schnitt-  
Wundspreizer, mit Mittelvalve 10 x 18 mm  
47-224-01  
Trigger finger and small wound retractor,  
with central valve 10 x 18 mm 47-224-01  
Separador para dedos y pequeñas heridas,  
con valva central 10 x 18 mm 47-224-01  
Impugnatura a molla per dita e piccolo  
divaricatore per ferite, con valva centrale  
10 x 18 mm 47-224-01



**VICKERS**

**47-223-00** 7,5 cm, 3"

Mittelvalve  
Central valve  
Valva central  
Valva centrale



**VICKERS**

**47-224-01** 10 x 18 mm

Mittelvalve  
Central valve  
Valva central  
Valva centrale



**VICKERS**

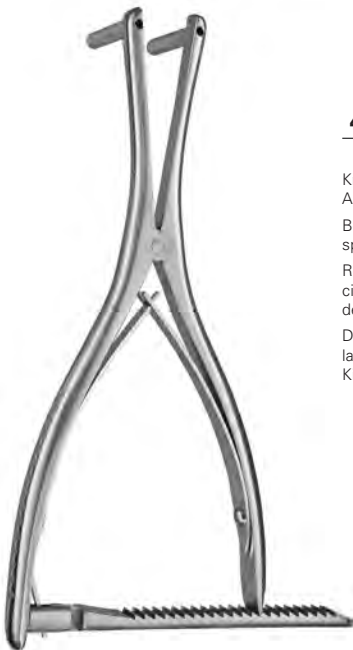
**47-224-02** 10 x 12 mm

Finger-Wundspreizer  
Finger retractor  
Separador para dedos  
Divaricatore per dita



**VICKERS**

**47-225-00** 5,0 cm, 2"



< Ø 2,0 mm

**47-250-17**

Knochen- und Gelenkspreizer zum  
 Aufspreizen über Kirschner Drähte

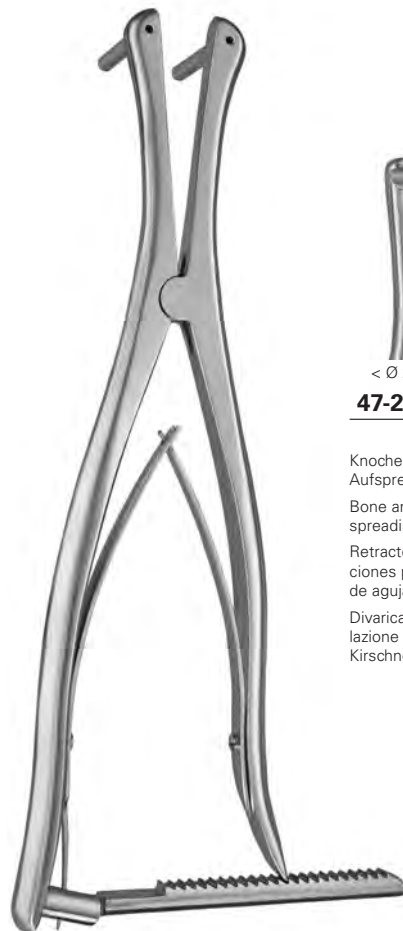
Bone and joint spreader for  
 spreading over Kirschner wires

Retradores de huesos y articula-  
 ciones para la separación a través  
 de agujas de Kirschner

Divaricatore per ossa e artico-  
 lazione da utilizzare con filo di  
 Kirschner

**HINTERMANN**

**47-250-17** 17,0 cm, 6 3/4"



< Ø 2,0 mm

**47-250-25**

Knochen- und Gelenkspreizer zum  
 Aufspreizen über Kirschner Drähte

Bone and joint spreader for  
 spreading over Kirschner wires

Retradores de huesos y articula-  
 ciones para la separación a través  
 de agujas de Kirschner

Divaricatore per ossa e artico-  
 lazione da utilizzare con filo di  
 Kirschner

**HINTERMANN**

**47-250-25** 25,0 cm, 9 3/4"

# 48

Gips- und Verbandinstrumente

Plaster and Dressing Instruments

Instrumentos para vendajes y yeso

Strumenti per bendaggi e gessature





**SMITH**

**48-000-20** 20,0 cm, 8"  
**48-000-23** 23,0 cm, 9"



**48-001-31** 31,0 cm, 12¼"



**LANGE**

**48-002-18** 18,0 cm, 7"



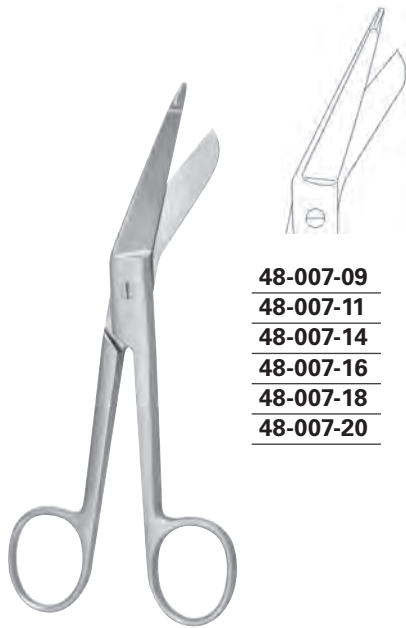
**KNOWLES**

**48-005-14** 14,0 cm, 5½"



**KNOWLES**

**48-006-14** 14,0 cm, 5½"



**48-007-09**  
**48-007-11**  
**48-007-14**  
**48-007-16**  
**48-007-18**  
**48-007-20**

**LISTER**

<b>48-007-09</b>	9,0 cm, 3 1/2 "
<b>48-007-11</b>	11,0 cm, 3 3/8 "
<b>48-007-14</b>	14,0 cm, 5 1/2 "
<b>48-007-16</b>	16,0 cm, 6 1/4 "
<b>48-007-18</b>	18,0 cm, 7 "
<b>48-007-20</b>	20,0 cm, 8 "



**48-007-14 L**  
**48-007-18 L**  
**48-007-20 L**

für die linke Hand  
 left handed  
 para la mano izquierda  
 per la mano sinistra

**LISTER**

<b>48-007-14 L</b>	14,0 cm, 5 1/2 "
<b>48-007-18 L</b>	18,0 cm, 7 "
<b>48-007-20 L</b>	20,0 cm, 8 "

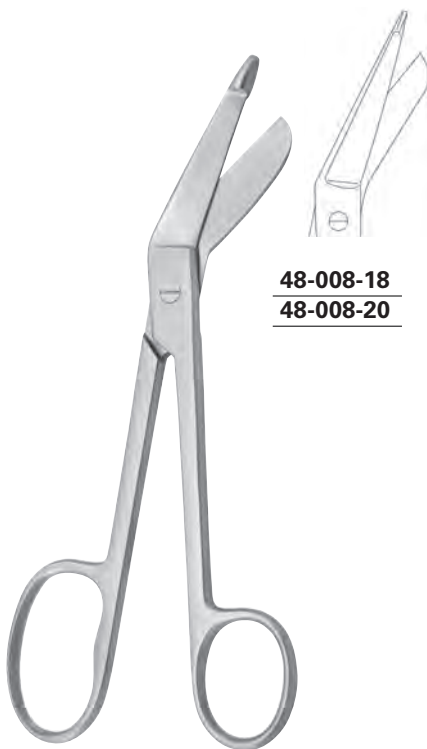


**48-007-14 SC**  
**48-007-18 SC**  
**48-007-20 SC**



**LISTER**

<b>48-007-14 SC</b>	14,0 cm, 5 1/2 "
<b>48-007-18 SC</b>	18,0 cm, 7 "
<b>48-007-20 SC</b>	20,0 cm, 8 "



**48-008-18**  
**48-008-20**

**LISTER**

<b>48-008-18</b>	18,0 cm, 7 "
<b>48-008-20</b>	20,0 cm, 8 "



**48-008-20 SC**

**LISTER**

<b>48-008-20 SC</b>	20,0 cm, 8 "
---------------------	--------------



**48-009-14**  
**48-009-18**  
**48-009-20**



**LISTER**

<b>48-009-14</b>	14,0 cm, 5 1/2 "
<b>48-009-18</b>	18,0 cm, 7 "
<b>48-009-20</b>	20,0 cm, 8 "

Frauenmodell  
 Female pattern  
 Modelo femenino  
 Modello da donna



**MICK**

**48-010-17 F** 17,5 cm, 6 3/4"

**Gipsschere nach MICK**

In Zusammenarbeit mit dem langjährig erfahrenen Gipspfleger Friedrich MICK haben wir eine Gipsschere für den Einsatz mit den heute gängigen Gips- und Kunststoffmaterialien entwickelt. Die besondere Ergonomie der Schere ist geeignet für ein ermüdungs-freies Arbeiten im Dauereinsatz. Durch die Unterteilung in ein Männer- und ein Frauenmodell ist die Gipsschere nach Mick für jeden Handtyp bestens geeignet.

**Besondere Merkmale der Gipsschere nach MICK:**

- Hervorragende Kraftübertragung durch aktiven Einsatz aller Finger einer Hand
- Spezialvergoldete Schnittfläche (Super Cut Schliff)
- Ergonomische Anpassung der Griffform
- Reinigungsfreundliche Hochglanzoberfläche
- Speziell angepasste Varianten für Männer- bzw. Frauenhand ermöglichen einen ermüdungsfreien Einsatz

**MICK Cast Scissors**

In cooperation with Friedrich MICK, a male nurse with many years of experience in the care of orthopedic casts, we have developed cast scissors for use with plaster and plastic materials common today. Continuous, fatigue-free use is made possible by the special ergonomics of the scissors. Due to the classification into a men's and women's pattern, the MICK Cast Scissors are ideal for any type of hand.

**Special characteristics of the MICK Cast Scissors:**

- Excellent power transfer by actively using all fingers of one hand
- Specially hardened and tempered cutting surface (Super Cut)
- Shape of the handle ergonomically designed
- Easy-to-clean highly-polished surface
- Specially adapted pattern for men's and women's hands considerably reduce fatigue for medical staff

**Tijeras para cortar yeso según MICK**

Trabajando en colaboración con el experimentado experto en escayolas Friedrich MICK, hemos desarrollado unas tijeras concebidas para los materiales sintéticos y de escayola que se utilizan hoy en día. La perfecta ergonomía de estas tijeras permite trabajar de forma continua con ellas sin sentir fatiga. Además, como existe un modelo para hombres y uno para mujeres, las tijeras para cortar yeso según Mick se adaptan a la anatomía de cualquier mano.

**Características especiales de las tijeras para cortar yeso según MICK:**

- Magnífica transferencia de fuerza gracias al uso activo de todos los dedos de una mano.
- Superficie de corte con un tratamiento especial (afilado Supercut)
- Adaptación ergonómica de la forma del mango
- Superficie de alto brillo fáciles de limpiar
- Las variantes especialmente adaptadas a las manos masculinas y femeninas reducen la fatiga durante el uso

**Forbici per gessi di MICK**

Grazie alla collaborazione di Friedrich MICK, un gessista che vanta una lunga esperienza, abbiamo sviluppato una forbice per gessi adatta ai materiali sintetici ai gessi utilizzati attualmente. La particolare ergonomia delle forbici rende più semplice l'utilizzo prolungato. Grazie ai due modelli per uomo e donna, le forbici per gesso di Mick si adattano perfettamente a ogni tipo di mano.

**Particolari caratteristiche delle cesoie per gesso di MICK:**

- Eccellente trasmissione della forza mediante l'impiego di tutte le dita di una mano
- Superficie di taglio ottimizzata (Super Cut Schliff)
- Impugnatura ergonomica
- Superficie lucida per facilitare la pulizia
- Modelli speciali adatti per le mani di uomini e donne consentono un utilizzo semplice

Männermodell  
 Male pattern  
 Modelo masculino  
 Modello da uomo



**MICK**

**48-010-17 M** 17,5 cm, 6 3/4"







**MICK**

**48-010-16** 16,0 cm, 6 ¼ "

#### Fuss-Verbandschere nach MICK

Speziell für schwer zugängliche Stellen, z.B. Fussrücken, Ellenbogen und Handrücken wurde von Friedrich MICK die stark abgerundete Verbandschere für den Gippspalt entwickelt. Die ergonomisch angepasste Biegung der Fuss-Verbandschere nach MICK in Verbindung mit dem SUPERCUT Schliff, ermöglicht ein problemloses Durchtrennen der Unterpolsterung bis zur letzten Faser.

Besondere Merkmale der Fuss-Verbandschere nach MICK:

- Spezialvergütete Schnittfläche (Super Cut Schliff)
- Reinigungsfreundliche Hochglanzoberfläche
- Die spezielle Form der Fuss-Verbandschere n. MICK ermöglicht ein sicheres durchgleiten zwischen Haut und Unterpolsterung.

#### MICK Foot Plaster Scissors

This strongly curved plaster scissors was especially developed from Friedrich MICK to reach hard accessible areas as such as dorsum of foot, elbow and back of the hand. The ergonomically curve of this MICK foot-plaster scissors in combination with the SUPERCUT feature allows the easy cut through of the full cushion.

Special characteristics of the MICK Foot Plaster Scissors:

- Specially hardened and tempered cutting surface (Super Cut)
- Easy-to-clean highly-polished surface
- The very special design of the MICK Foot-Plaster Scissors allows a totally safe sliding between skin and cushion

#### Tijeras para vendajes según MICK

Friedrich MICK ha desarrollado unas tijeras para vendajes fuertemente redondeadas que están concebidas específicamente para cortar escayolas en puntos de difícil acceso, como el dorso del pie, el codo y el dorso de la mano. La flexión ergonómicamente adaptada de la tijera para vendajes según MICK, en combinación con el afilado Supercut, permite cortar hasta la última fibra del relleno interior de la escayola.

Características especiales de las tijeras para vendajes según MICK:

- Superficie de corte con un tratamiento especial (afilado Supercut)
- Superficie de alto brillo fácil de limpiar
- La forma especial de las tijeras para vendajes según MICK permite un deslizamiento seguro entre la piel y el relleno interior.

#### Forbici di MICK per bendaggi del piede

Sviluppate da Friedrich MICK in modo particolare per punti difficilmente accessibili, per esempio, il dorso del piede, il gomito e il dorso della mano, queste forbici per bendaggi sono molto smussate. La curvatura ergonomica della forcice di MICK per bendaggi del piede, insieme a al SUPERCUT Schliff, consentono il taglio dei materiali fino all'ultima fibra.

Particolari caratteristiche delle forbici di MICK per bendaggi del piede:

- Superficie di taglio ottimizzata (Super Cut Schliff)
- Superficie lucida per facilitare la pulizia
- La forma speciale della forcice di Mick per bendaggi del piede consentono lo scivolamento sicuro tra pelle e bendaggi.



**MICK**

**48-010-18** 18,0 cm, 7 "

#### Verbandschere nach MICK

Um das Scherenprogramm für den Gipsraum abzurunden haben wir mit Friedrich MICK eine spezielle Verbandschere entwickelt, die dem Anforderungsprofil der Anwender in Klinik und Praxis gerecht wird. Die langjährige Erfahrung von Friedrich MICK spiegelt sich besonders in der Ergonomie dieses Produkts, im Bereich der Griffe, des Handlings (Länge & Gewicht) und dem angepassten Verletzungsschutz am Ende des unteren Schneideblattes wieder.

Besondere Merkmale der Verbandschere nach MICK:

- Spezialvergütete Schnittfläche (Super Cut Schliff)
- Reinigungsfreundliche Hochglanzoberfläche
- Ergonomische Anpassung der Griffform

#### MICK Plaster Scissors

To complete the range of scissors for the plaster room, we have developed a special plaster scissors with Friedrich MICK, which fully meets the requirements of the user in hospitals and clinical practice. Friedrich MICK's long term experience is reflected in the ergonomics of this product, mainly at the handles, during usage (length & weight) and the aligned protection tip at the end of the lower blade.

Special characteristics of the MICK Plaster Scissors:

- Specially hardened and tempered cutting surface (Super Cut)
- Easy-to-clean highly-polished surface
- Shape of the handle ergonomically designed

#### Tijeras para vendajes MICK

Y, para completar la línea de tijeras, hemos desarrollado junto con Friedrich MICK unas tijeras para vendajes especiales que cumplen todos los requisitos del usuario, tanto en la clínica como en la práctica. La larga experiencia de Friedrich MICK se refleja de forma especial en la ergonomía de este producto en el mango o la manipulación (longitud y peso) y en la protección frente a daños adaptada que se incorpora al final de la hoja de corte inferior.

Características especiales de las tijeras para vendajes según MICK:

- Superficie de corte con un tratamiento especial (afilado Supercut)
- Superficie de alto brillo fácil de limpiar
- Adaptación ergonómica de la forma del mango

#### Forbici di MICK per bendaggi

Per completare la dotazione delle forbici per la sala gessi, abbiamo realizzato insieme a Friedrich MICK speciali forbici per bendaggi, che soddisfano le esigenze dell'operatore in ambito clinico e ambulatoriale. La lunga esperienza di Friedrich MICK si rispecchia in particolare nell'ergonomia di questo prodotto, nel manico, nell'impugnatura (lunghezza e peso) e nel design specificamente pensato per evitare eventuali lesioni che potrebbero verificarsi dopo aver tagliato gli strati inferiori.

Particolari caratteristiche delle forbici per bendaggi di MICK:

- Superficie di taglio ottimizzata (Super Cut Schliff)
- Superficie lucida per facilitare la pulizia
- Impugnatura ergonomica

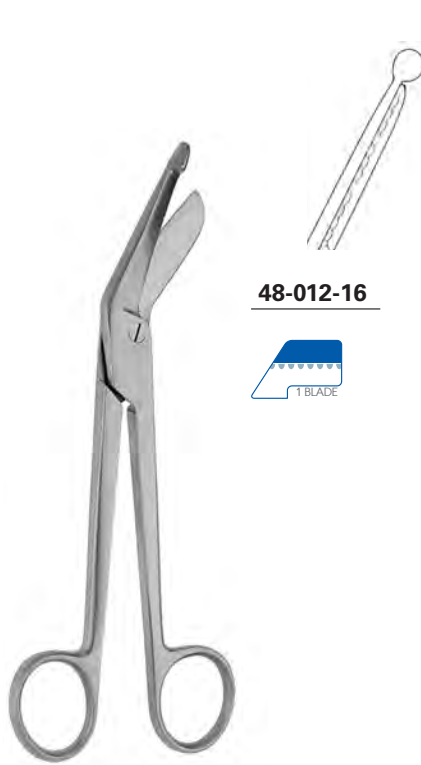


**48-011-16**  
**48-011-19**



**LISTER**

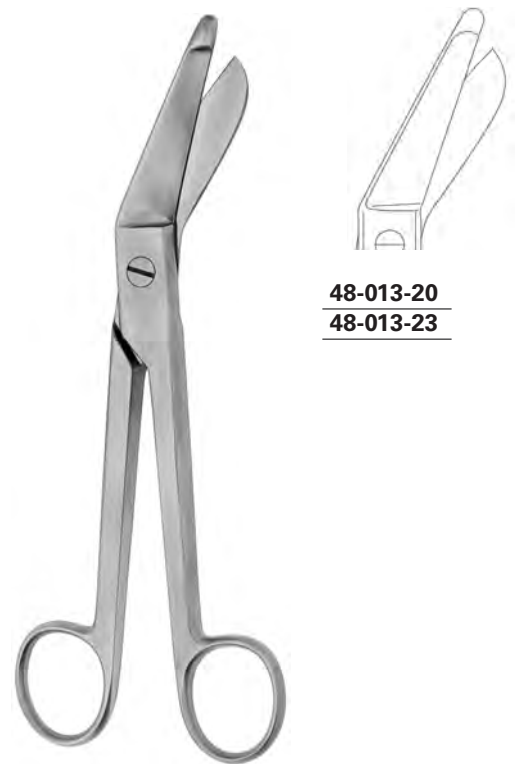
**48-011-16** 16,0 cm, 6 ¼"  
**48-011-19** 19,0 cm, 7 ½"



**48-012-16**



**48-012-16** 16,0 cm, 6 ¼"



**48-013-20**  
**48-013-23**

**ESMARCH**

**48-013-20** 20,0 cm, 8"  
**48-013-23** 23,0 cm, 9"



**BERGMANN**

**48-015-23** 23,0 cm, 9"



**LORENZ**

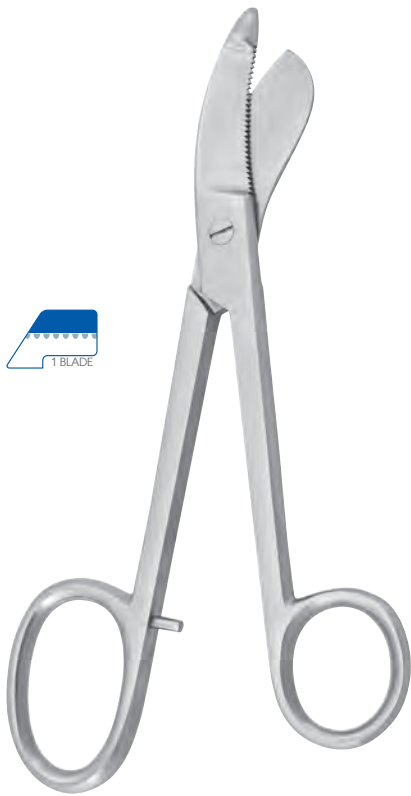
**48-016-23** 23,0 cm, 9"



**BRUNS**

**48-017-23** 23,5 cm, 9 ¼"





**BRUNS**

**48-017-24** 24,0 cm, 9 ¼ "



**BRUNS**

**48-019-23** 23,0 cm, 9 "



**48-030-20** 20,0 cm, 8 "



**48-021-15**  
**48-021-18**

**48-023-15**  
**48-023-18**

**48-025-15**  
**48-025-18**

**48-026-15**  
**48-026-18**

**48-027-15**  
**48-027-18**

**48-028-15**  
**48-028-18**

**48-029-15**  
**48-029-18**

**UNIVERSAL**

**48-021-15 - 48-029-15** 15,0 cm, 6 "  
**48-021-18 - 48-029-18** 18,0 cm, 7 "



**SEUTIN**

**48-030-23** 23,0 cm, 9 "



**STILLE**

**48-032-24** 24,0 cm, 9 ½"



**STILLE**

<b>48-033-20</b>	20,0 cm, 8"
<b>48-033-23</b>	23,0 cm, 9"
<b>48-033-26</b>	26,0 cm, 10 ¼"
<b>48-033-37</b>	37,0 cm, 14 ½"



**HAGLUND-STILLE**

**48-039-48** 28,0 cm, 11 "



**HENNIG**

**48-040-28** 28,0 cm, 11 "



**BEESON**

**48-042-30** 30,0 cm, 11 3/4 "



**QUATTRO**

**48-043-23** 23,0 cm, 9"



**MOD. USA**

**48-044-23** 23,0 cm, 9"



**WOLFF**

**48-045-18** 18,0 cm, 7"

**48-045-24** 24,0 cm, 9 1/2"



**ENGEL**

**48-046-14** 14,0 cm, 4 ½"



**BERGMANN**

**48-046-18** 18,0 cm, 7"



**WIGMORE**

**48-047-19** 19,0 cm, 7 ½"



**HOPKINS**

**48-048-20** 20,0 cm, 8"



**ESMARCH**

**48-050-18** 18,0 cm, 7"



**REINER**

**48-052-18** 18,5 cm, 7 ¼"



**MARTIN**

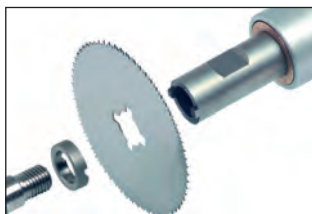
**48-054-21** 21,0 cm, 8 ¼"



- Robuste Konstruktion
- Hohe Belastbarkeit im Dauerbetrieb
- Vibrationsarm
- Eingebauter Überlastungsschutz
- Construcción robusta
- Alta capacidad de carga también en régimen continuo
- Amortiguación de la vibración
- Protección incorporada contra sobrecarga
- Robust construction
- Maximum capacity also in permanent service
- Low vibration
- Built-in overload protection
- Construzione robusta
- Alta capacità di carica a regime continuo
- Vibrazioni attenuate al minimo
- Protezione di sovraccarico incorporata

## ELECTRO POWER

**48-100-00** 230 V | 50 Hz  
**48-100-01** 120 V | 60 Hz



Komplett, bestehend aus:

1 Oszillierende Gips säge	
1 Sägeblatt, Ø 50 mm	<b>48-110-50</b>
1 Sägeblatt, Ø 65 mm	<b>48-110-65</b>
1 Gabelschlüssel, paar	<b>48-110-01</b>

Complete, consisting of:

1 Oscillating plaster saw	
1 Saw blade, Ø 50 mm	<b>48-110-50</b>
1 Saw blade, Ø 65 mm	<b>48-110-65</b>
1 Wrench, pair	<b>48-110-01</b>

Completo, compuesto de:

1 Sierra eléctrica oscilante yeso	
1 Hoja de sierra, Ø 50 mm	<b>48-110-50</b>
1 Hoja de sierra, Ø 65 mm	<b>48-110-65</b>
1 Llaves de boca, par	<b>48-110-01</b>

Completo, composto da:

1 Sega elettriche oscillante gesso	
1 Sega, Ø 50 mm	<b>48-110-50</b>
1 Sega, Ø 65 mm	<b>48-110-65</b>
1 Chiavi fisse, paio	<b>48-110-01</b>

### Technische Daten

Anschlußspannung 230 V~, 50 Hz / 110 V~, 60 Hz  
 Leistung 500 Watt  
 Schwingungen 3.500 bis 24.000 Schwingungen / Minute stufenlos regulierbar.  
 Anschlußkabel 5 Meter-Kabel mit Euro-Flachstecker (230 V)  
 3 Meter-Kabel mit USA-Stecker (110 V)  
 Gewicht: 1,3 kg (1,5 kg mit Kabel)

### Technical data

Supply voltage 230 V~, 50 Hz / 110 V~, 60 Hz  
 Power 500 Watt  
 Oscillations 3.500 to 24.000 oscillations / minute steplessly adjustable  
 Connection cable 5 meter cable with Euro-plug (230 V)  
 3 meter cable with USA-plug (110 V)  
 Weight: 1,3 kg (1,5 kg with cable)

### Datos técnicos

Tensión de alimentación 230 V~, 50 Hz / 110 V~, 60 Hz  
 Potencia absorbida 500 Watt  
 Oscilaciones de 3.500 a 24.000 oscilaciones por minuto regulación progresiva.  
 Cable de alimentación: Cable de 5 metros con enchufe plano para Europa (230 V) Cable de 3 metros con enchufe para EE.UU. (110 V)  
 Peso: 1,3 kg (1,5 kg con cable)

### Dati tecnici

Tensione di collegamento 230 V~, 50 Hz / 110 V~, 60 Hz  
 Potenza assorbita 500 Watt  
 Oscillazioni da 3.500 a 24.000 oscillazioni al minuto, con regolazione continua  
 Cavo di collegamento: Cavo da 5 metri con spina piatta europea (230 V)  
 Cavo di 3 metri con spina USA (110 V)  
 Peso 1,3 kg (1,5 kg con cavo)



- Geringes Gewicht
- Geräuscharm
- Permanentmagnetmotor
- Low weight
- Noise reduced
- Permanent magnet engine
- Peso bajo
- Ruido reducido
- Motor permanente del imán
- Peso ridotto
- Rumore ridotto
- Motore permanente del magnete

## BLUE POWER

<b>48-106-00</b>	230 V   50 Hz
<b>48-106-01</b>	110 V   60 Hz

Komplett, bestehend aus:

Complete, consisting of:

1 Oszillierende Gipssäge		1 Oscillating plaster saw	
1 Sägeblatt, Ø 50 mm	<b>48-110-50</b>	1 Saw blade, Ø 50 mm	<b>48-110-50</b>
1 Sägeblatt, Ø 65 mm	<b>48-110-65</b>	1 Saw blade, Ø 65 mm	<b>48-110-65</b>
1 Gabelschlüssel, paar	<b>48-110-01</b>	1 Wrench, pair	<b>48-110-01</b>

Completo, compuesto de:

Completo, composto da:

1 Sierra eléctrica oscilante yeso		1 Sega elettriche oscillante gesso	
1 Hoja de sierra, Ø 50 mm	<b>48-110-50</b>	1 Sega, Ø 50 mm	<b>48-110-50</b>
1 Hoja de sierra, Ø 65 mm	<b>48-110-65</b>	1 Sega, Ø 65 mm	<b>48-110-65</b>
1 Llaves de boca, par	<b>48-110-01</b>	1 Chiavi fisse, paio	<b>48-110-01</b>



### Technische Daten

Anschlußspannung 230/240 V~, 50/60 Hz / 110/115 V~, 60 Hz  
 Leistung 210 Watt  
 10.000 bis 19.000 Schwingungen / Minute stufenlos regulierbar.  
 Anschlußkabel 3 Meter-Kabel mit Euro-Flachstecker (230/240 V)  
 3 Meter-Kabel mit USA-Stecker (110/115 V)  
 Gewicht: 0,97 kg (1,16 kg mit Kabel)

### Technical data

Supply voltage 230/240 V~, 50/60 Hz / 110/115 V~, 60 Hz  
 Power 210 Watt  
 10.000 to 19.000 oscillations / minute steplessly adjustable  
 Connection cable 3 meter cable with Euro-plug (230/240 V)  
 3 meter cable with USA-plug (110/115 V)  
 Weight: 0,97 kg (1,16 kg with cable)

### Datos técnicos

Tensión de alimentación 230/240 V~, 50/60 Hz / 110/115 V~, 60 Hz  
 Potencia absorbida 210 Watt  
 10.000 a 19.000 oscilaciones por minuto regulación progresiva.  
 Cable de alimentación: Cable de 3 metros con enchufe plano para Europa (230/240 V)  
 Cable de 3 metros con enchufe para EE.UU. (110/115 V)  
 Peso: 0,97 kg (1,16 kg con cable)

### Dati tecnici

Tensione di collegamento 230/240 V~, 50/60 Hz / 110/115 V~, 60 Hz  
 Potenza assorbita 210 Watt  
 10.000 a 19.000 oscillazioni al minuto, con regolazione continua  
 Cavo di collegamento: Cavo da 3 metri con spina piatta europea (230/240 V)  
 Cavo di 3 metri con spina USA (110/115 V)  
 Peso 0,97 kg (1,16 kg con cavo)



komplett mit Säge  
 complete with saw  
 completo con sierra  
 completo con sega



## ELECTRO POWER

**48-105-00** 230 V | 50 Hz

Komplett, bestehend aus:

1 Oszillierende Gipssäge	<b>48-100-00</b>
1 Sägeblatt, Ø 50 mm	<b>48-110-50</b>
1 Sägeblatt, Ø 65 mm	<b>48-110-65</b>
1 Gabelschlüssel, paar	<b>48-110-01</b>
1 Staubsauger inkl. Schlauch und Ständer	
1 Ablageschale für Gipssäge	
1 Saugdüse für die Befestigung des Schlauches an der Gipssäge	
1 Filter und Papiersäcke	

Completo, compuesto de:

1 Sierra eléctrica oscilante	<b>48-100-00</b>
1 Hoja de sierra, Ø 50 mm	<b>48-110-50</b>
1 Hoja de sierra, Ø 65 mm	<b>48-110-65</b>
1 Llaves de boca, par	<b>48-110-01</b>
1 Aspirador incl. manguera de aspiración y soporte	
1 Bandeja para depositar la sierra de yeso	
1 Tobera aspiradora para la fijación de la manguera de aspiración a la sierra de yeso	
1 Filtros y saco de papel	

Complete, consisting of:

1 Oscillating plaster saw	<b>48-110-00</b>
1 Saw blade, Ø 50 mm	<b>48-110-50</b>
1 Saw blade, Ø 65 mm	<b>48-110-65</b>
1 Wrench, pair	<b>48-110-01</b>
1 Vacuum cleaner incl. suction tube and support device for tube	
1 Support plate for plaster saw	
1 Suction nozzle to connect the suction tube to the plaster saw	
1 Filters and paper bags	

Completo, composto da:

1 Sega elettriche oscillante	<b>48-100-00</b>
1 Sega, Ø 50 mm	<b>48-110-50</b>
1 Sega, Ø 65 mm	<b>48-110-65</b>
1 Chiavi fisse, paio	<b>48-110-01</b>
1 Aspiratore incl. tubo di aspirazione e supporto	
1 Appoggio per sega gessi	
1 Ugello per l'applicazione del tubo d' aspirazione alla sega	
1 Filtri e sacchetto di carta	

### Technische Daten

Anschlußspannung 230 V~, 50 Hz  
 Dauerleistung 400 - 750 Watt  
 Spitzenleistung 900 Watt  
 Filtrierung HEPA Filter 99,97 % (0,3 micron)  
 Tankinhalt 20 l  
 Luftstrom 52 l/s  
 Geräuschpegel 65 - 80 db (+-5)

### Datos técnicos

Tensión de alimentación 230 V~, 50 Hz  
 Redimiento continuo 400 - 750 watio  
 Redimiento máximo 900 watio  
 Filtración HEPA Filter 99,97 % (0,3 micron)  
 Capacidad del tanque 20 l  
 Corriente atmosférica 52 l/s  
 Nivel de ruido 65 - 80 db (+-5)

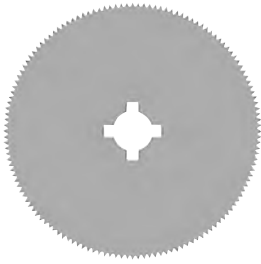
### Technical data

Supply voltage 230 V~, 50 Hz  
 Permanent power 400 - 750 Watt  
 Top power 900 Watt  
 Filtration HEPA Filter 99,97 % (0,3 micron)  
 Tank capacity 20 l  
 Air volume 52 l/s  
 Noise level 65 - 80 db (+-5)

### Dati tecnici

Tensione di collagamento 230 V~, 50 Hz  
 Alimentazione permanente 400 - 750 Watt  
 Alimentazione superiore 900 Watt  
 Filtrazione HEPA Filter 99,97 % (0,3 micron)  
 Capacità del cassone 20 l  
 Volume di aria 52 l/s  
 Livello del rumore 65 - 80 db (+-5)



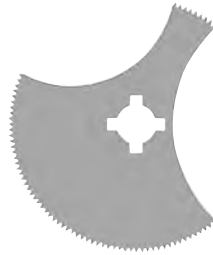


**48-110-45** Ø 45,0 mm

**48-110-50** Ø 50,0 mm

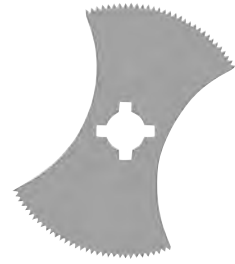
**48-110-65** Ø 65,0 mm

Sägeblatt für Naturgipsverbände  
 Saw blade for normal plaster  
 Hoja de sierra para vendaje de yeso  
 Sega per bendaggi in gesso naturale



**48-130-65** Ø 65,0 mm

Sägeblatt Autopsie für Naturgipsverbände  
 Autopsy saw blade for normal plaster  
 Hoja de sierra de autopsia para vendaje de yeso  
 Sega autopsia per bendaggi in gesso naturale



**48-150-65** Ø 65,0 mm

Sägeblatt Segment für Naturgipsverbände  
 Segmented saw blade for normal plaster  
 Hoja de sierra de segmentos para vendaje de yeso  
 Sega segmento per bendaggi in gesso naturale

**48-120-45** Ø 45,0 mm

**48-120-50** Ø 50,0 mm

**48-120-65** Ø 65,0 mm

Sägeblatt für synthetische Hartverbände  
 Saw blade for synthetic casts  
 Hoja de sierra de profundidad para vendajes sintéticos rígidos  
 Sega per bendaggi duri sintetici

**48-140-65** Ø 65,0 mm

Sägeblatt Autopsie für synthetische Hartverbände  
 Autopsy saw blade for synthetic casts  
 Hoja de sierra de autopsia para vendajes sintéticos rígidos  
 Sega autopsia per bendaggi duri sintetici

**48-160-65** Ø 65,0 mm

Sägeblatt Segment für synthetische Hartverbände  
 Segmented saw blade for synthetic casts  
 Hoja de sierra de segmentos para vendajes sintéticos rígidos  
 Sega segmento per bendaggi duri sintetici



**48-170-08** 8,0 mm

**48-170-20** 20,0 mm

Tiefensägeblatt für Naturgipsverbände  
 Deep saw blade for normal plaster  
 Hoja de sierra de profundidad para vendaje de yeso  
 Sega a taglio di profondità per bendaggi in gesso naturale



**48-190-99** Ø 65,0 mm

Exzentrische Begrenzungsscheibe für Tiefenbegrenzung  
 Excentric disc to limit depth of cut  
 Disco de tope excéntrico para tope de profundidad  
 Disco di limitazione eccentrico per limitazione della profondità



**48-110-01**

Gabelschlüssel für Sägeblattwechsel, Paar  
 Wrenches for exchange of saw blades, pair  
 Llaves de boca para cambiar la hoja de sierra, par  
 Chiavi per cambiare la lama per sega, paio

**48-180-08** 8,0 mm

**48-180-20** 20,0 mm

Tiefensägeblatt für synthetische Hartverbände  
 Deep saw blade for synthetic casts  
 Hoja de sierra de profundidad para vendaje sintéticos rígidos  
 Sega a taglio di profondità per bendaggi duri sintetici



**48-110-02**

Transportkoffer, blau, inklusive Formeinlage für BLUE oder ELEKTRO POWER  
 Transport case, blue, including inlay for BLUE or ELECTRO POWER  
 Transporte valija, azul, inclusive pieza postiza per BLUE o ELECTRO POWER  
 Cargo valigetta, blu, incluso inserto per BLUE o ELECTRO POWER



# 49

Arthroskopie Instrumente  
Arthroscopy Instruments  
Instrumentos para Artroscopia  
Strumenti per Artroscopia





# 50

Stationsinstrumente

Ward Instruments

Instrumentos para enfermería

Strumenti per medicazione





**50-005-08** 8,5 cm, 3 1/3"



**50-006-09** 9,0 cm, 3 1/2"  
**50-006-10** 10,0 cm, 4"



**50-007-09** 9,0 cm, 3 1/2"  
**50-007-10** 10,0 cm, 4"



**50-008-09** 9,0 cm, 3 1/2"  
**50-008-10** 10,5 cm, 4 1/4"



**50-009-09** 9,0 cm, 3 1/2"  
**50-009-10** 10,5 cm, 4 1/4"



**50-014-09** 9,5 cm, 3 3/4"



**50-015-09** 9,5 cm, 3 3/4"



**SYSTRUNK**  
**50-017-13** 13,0 cm, 5 1/8"



**50-018-02**

**50-018-02** 10,5 cm, 4 ¼"

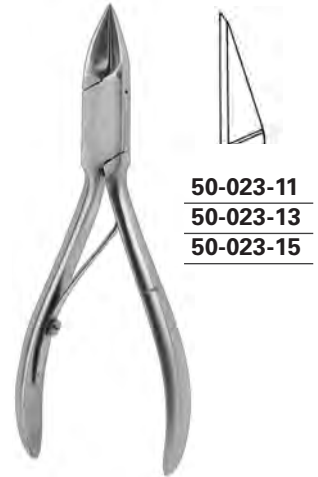


**50-021-11**

**50-021-11** 11,0 cm, 4 ⅜"



**50-022-12** 12,0 cm, 4 ¾"



**50-023-11**  
**50-023-13**  
**50-023-15**

**50-023-11** 11,5 cm, 4 ½"  
**50-023-13** 13,0 cm, 5 ⅛"  
**50-023-15** 15,0 cm, 6"



## TURNBULL

**50-024-11** 11,5 cm, 4 ½"  
**50-024-13** 13,0 cm, 5 ⅛"



**50-024-14** 14,0 cm, 5 ½"



**50-025-14** 14,0 cm, 5 ½"



**50-026-14** 14,0 cm, 5 ½"



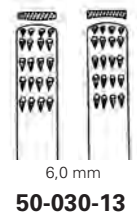
**50-027-14** 14,0 cm, 5 1/2"  
**50-027-16** 16,0 cm, 6 1/4"



**50-028-15** 15,0 cm, 6"



**ANVIL**  
**50-029-13** 13,5 cm, 5 1/4"



**RADOLF**  
**50-030-13** 13,0 cm, 5 1/8"



**50-031-11** 11,0 cm, 4 3/8"



**50-032-10** 10,0 cm, 4"  
**50-032-12** 12,0 cm, 4 3/4"



**50-032-16** 16,0 cm, 6 1/4"







Schwesterngarnitur  
Set for nurses  
Surtido para enfermeras  
Nexessario per infermiera

**50-040-00** SET



0,99 mm  
**50-034-01**

Bohrer, allein  
Drill, only  
Brocas, sueltas  
Trapano, solo

1,40 mm  
**50-034-02**

Bohrer, allein  
Drill, only  
Brocas, sueltas  
Trapano, solo

2,28 mm  
**50-034-03**

Bohrer, allein  
Drill, only  
Brocas, sueltas  
Trapano, solo

Nagelbohrer, komplett  
Finger nail drill, complete  
Taladro para uñas, completo  
Ghiaccia unghie, completo

**50-034-00** SET

Schwesterngarnitur  
Set for nurses  
Surtido para enfermeras  
Nexessario per infermiera



**50-040-01** SET

Hornhauthobel, nicht sterilisierbar  
Callosity Plane, not autoclavable  
Cuchillas corta-callos, no esterilizables  
Lima per cute ispessita, non sterilizzabile



**CREDO**

**50-050-00** 14,0 cm, 5 1/2"



Verpackungseinheit: 10 St.  
Packing unit: 10 pieces  
Unidad: 10 piezas  
Confezione: 10 pezzi

Rasierklingen, brechbar  
Razor blades, breakable  
Hojas de afeitár, rompibles  
Lamette di rasoio, per rompere,



**50-050-01**

STEEL  
STAINLESS



**50-054-15**



**RALK**

**50-054-15** 15,0 cm, 6"



**50-055-11**



**PEET**

**50-055-11** 11,0 cm, 4 3/8"



**50-056-13**



**50-057-13**



**STIEGLITZ**

**50-056-13 - 50-057-13** 13,5 cm, 5 1/4"



**50-058-13**



**50-059-13**



**STIEGLITZ**

**50-058-13 - 50-059-13** 13,5 cm, 5 1/4"



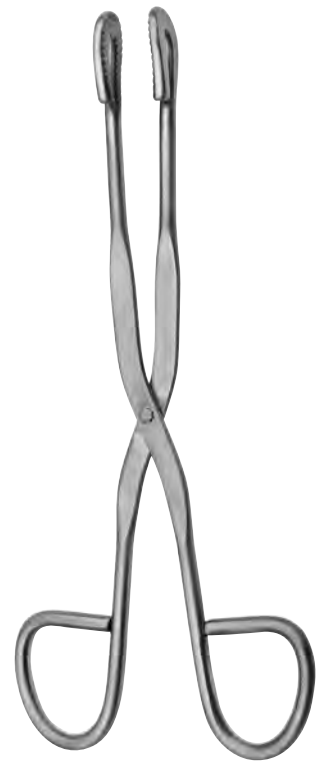
**DAVIS**

<b>50-060-16</b>	16,0 cm, 6 ¼"
<b>50-060-20</b>	20,0 cm, 8"
<b>50-060-24</b>	24,0 cm, 9 ½"



**CHEATTLE**

<b>50-061-28</b>	28,0 cm, 11"
------------------	--------------



**UNIVERSAL**

<b>50-062-20</b>	20,0 cm, 8"
<b>50-062-30</b>	30,0 cm, 11 ¾"



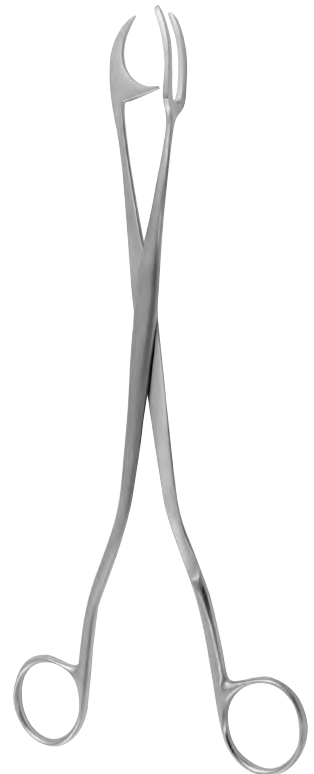
**UNIVERSAL**

<b>50-063-20</b>	20,0 cm, 8"
<b>50-063-30</b>	30,0 cm, 11 ¾"



**UNIVERSAL**

<b>50-064-20</b>	20,0 cm, 8"
<b>50-064-30</b>	30,0 cm, 11 ¾"



**ROGGE**

<b>50-066-23</b>	23,0 cm, 9"
------------------	-------------



# 51

Behälter, Gefäße

Stainless Steel Holloware

Recipientes

Recipienti



Nierenschalen  
Kidney Dishes  
Riñoneras  
Bacinelle reniformi



<b>51-100-17</b>	170 x 100 x 35 mm
<b>51-100-25</b>	250 x 140 x 40 mm
<b>51-100-27</b>	270 x 150 x 45 mm

Runde Schalen  
Round Bowls  
Cubetas redondas  
Scodelle rotonde



<b>51-101-14</b>	140 x 55 mm	0,50 l
<b>51-101-16</b>	150 x 75 mm	0,75 l
<b>51-101-17</b>	160 x 75 mm	1,00 l
<b>51-101-22</b>	220 x 75 mm	2,00 l
<b>51-101-23</b>	225 x 90 mm	2,50 l
<b>51-101-24</b>	240 x 95 mm	3,00 l
<b>51-101-25</b>	255 x 115 mm	3,50 l
<b>51-101-27</b>	260 x 120 mm	4,50 l
<b>51-101-29</b>	290 x 125 mm	6,00 l
<b>51-101-31</b>	300 x 115 mm	6,00 l
<b>51-101-34</b>	320 x 140 mm	8,50 l
<b>51-101-38</b>	380 x 130 mm	11,00 l
<b>51-101-41</b>	400 x 155 mm	14,00 l

Runde Schalen  
Round Bowls  
Cubetas redondas  
Scodelle rotonde



<b>51-103-04</b>	Ø 40 x 19 mm	0,05 l
<b>51-103-06</b>	Ø 61 x 30 mm	0,07 l
<b>51-103-08</b>	Ø 80 x 40 mm	0,14 l
<b>51-103-11</b>	Ø 116 x 50 mm	0,35 l
<b>51-103-12</b>	Ø 128 x 55 mm	0,45 l
<b>51-103-14</b>	Ø 147 x 65 mm	0,70 l
<b>51-103-16</b>	Ø 210 x 90 mm	2,50 l

Runde Schalen  
Round Bowls  
Cubetas redondas  
Scodelle rotonde



<b>51-105-11</b>	Ø 116 x 35 mm	0,30 l
<b>51-105-12</b>	Ø 128 x 38 mm	0,40 l
<b>51-105-14</b>	Ø 147 x 40 mm	0,50 l
<b>51-105-15</b>	Ø 157 x 45 mm	0,75 l
<b>51-105-18</b>	Ø 187 x 45 mm	1,00 l

Lösungsschalen  
Solution bowls  
Cubetas para soluciones  
Arcelle



<b>51-106-04</b>	Ø 50 x 45 mm	0,05 l
<b>51-106-05</b>	Ø 60 x 52 mm	0,07 l

Lösungsschalen  
Solution bowls  
Cubetas para soluciones  
Arcelle



<b>51-106-10</b>	Ø 75 x 103 mm	0,25 l
------------------	---------------	--------



Standgefäße  
Jars  
Recipientes  
Recipienti



<b>51-107-01</b>	Ø 30 x 90 mm
<b>51-107-02</b>	Ø 50 x 100 mm
<b>51-107-03</b>	Ø 50 x 130 mm
<b>51-107-04</b>	Ø 50 x 175 mm
<b>51-107-05</b>	Ø 75 x 100 mm
<b>51-107-06</b>	Ø 75 x 130 mm
<b>51-107-07</b>	Ø 75 x 175 mm
<b>51-107-08</b>	Ø 85 x 175 mm
<b>51-107-09</b>	Ø 95 x 200 mm

Medizinlöffel, innen graduert  
Medicine spoon, graduated inside  
Cuchara medicinal, graduado interiormente  
Cucchiaio per medicine, graduato all'interno



**51-109-00** 110 x 30 mm 12,5 ml

Medizinbecher, innen graduert  
Medicine cup, graduated inside  
Vaso medicinal, graduado interiormente  
Bicchieri per medicinale, graduato all'interno



**51-109-01** 50 x 25 mm 25,0 ml

Messbecher, innen graduert  
Measuring cup, graduated inside  
Vaso-medidas, graduado interiormente  
Bicchieri graduati, graduato all'interno

Medizinbecher, innen graduert  
Medicine cup, graduated inside  
Vaso medicinal, graduado interiormente  
Bicchieri per medicinale, graduato all'interno



**51-109-02** Ø 53 x 45 mm 50,0 ml



<b>51-109-03</b>	0,25 l
<b>51-109-04</b>	0,50 l
<b>51-109-05</b>	1,00 l
<b>51-109-06</b>	2,00 l

Messbecher, innen graduert  
Measuring cup, graduated inside  
Vaso-medidas, graduado interiormente  
Bicchieri graduati, graduato all'interno



**51-110-00** 100,0 ml

Dosen, mit Knopfdeckel  
Dish, lid with knob  
Recipientes, tapa con botón  
Recipienti con coperchio a bottone



**51-111-01** Ø 75 x 60 mm  
**51-111-02** Ø 75 x 75 mm  
**51-111-03** Ø 100 x 60 mm  
**51-111-04** Ø 100 x 100 mm  
**51-111-05** Ø 125 x 80 mm  
**51-111-06** Ø 125 x 125 mm  
**51-111-07** Ø 150 x 150 mm

Sputumbecher  
Sputum cup  
Escupidera  
Sputacchiera



**51-112-09** Ø 75 x 75 mm 0,30 l

Mundbecher  
Metal cup  
Vaso metálico  
Bicchieri metallico



**51-112-90** Ø 90 x 90 mm

Runde Schale  
Round bowl  
Cubetas redondas  
Scodelle rotonde



**51-113-15** Ø 110 x 28 mm 0,15 l

Petrirschale  
Petri dish  
Cápsulas de Petri  
Scodella di Petri



**51-116-00** SET

Schale, allein  
Dish, only  
Cápsulas, suelta  
Scodella, solo

**51-116-01** Ø 96 x 20 mm

Deckel, allein  
Lid, only  
Tapa, suelta  
Coperchio, solo

**51-116-02** Ø 100 x 20 mm





Irrigatoren  
Irrigators  
Irrigadores  
Irrigatori



<b>51-119-01</b>	Ø 100 x 160 mm	1,00 l
<b>51-119-02</b>	Ø 130 x 170 mm	1,50 l
<b>51-119-03</b>	Ø 130 x 190 mm	2,00 l

Stechbecken  
Bed Pans  
Stilletas  
Padelle



<b>51-120-00</b>	Ø 310 x 80 mm
<b>51-120-01</b>	Ø 230 x 70 mm

Instrumentenschalen  
Instrument trays  
Bandejas para instrumentos  
Bacinelle per strumenti



<b>51-120-23</b>	230 x 155 x 30 mm
<b>51-120-30</b>	300 x 175 x 30 mm
<b>51-120-31</b>	300 x 175 x 40 mm
<b>51-120-35</b>	350 x 240 x 40 mm
<b>51-120-40</b>	400 x 300 x 50 mm

Instrumentenschalen  
Instrument trays  
Bandejas para instrumentos  
Bacinelle per strumenti



<b>51-131-23</b>	235 x 190 x 40 mm
------------------	-------------------

Urinal, weiblich  
Urinal, female  
Orinal, mujer  
Urinale, donna



**51-121-01** 220 x 140 mm

Urinal, männlich  
Urinal, male  
Orinal, hombre  
Urinale, uomo



**51-121-02** 215 x 120 mm

Instrumentenschalen  
Instrument trays  
Bandejas para instrumentos  
Bacinelle per strumenti



**51-130-01** 210 x 160 x 10 mm  
**51-130-02** 240 x 180 x 10 mm  
**51-130-03** 310 x 150 x 10 mm  
**51-130-04** 310 x 210 x 10 mm  
**51-130-05** 350 x 240 x 10 mm  
**51-130-06** 400 x 270 x 20 mm  
**51-130-07** 420 x 280 x 10 mm

Instrumentenkästen  
Instrument boxes  
Cajas para instrumentos  
Scatole per strumenti



**51-140-01** 100 x 60 x 40 mm  
**51-140-02** 120 x 80 x 40 mm  
**51-140-03** 160 x 100 x 30 mm  
**51-140-04** 180 x 120 x 50 mm  
**51-140-05** 200 x 100 x 50 mm  
**51-140-06** 220 x 150 x 50 mm  
**51-140-07** 260 x 150 x 50 mm  
**51-140-08** 300 x 200 x 50 mm  
**51-140-09** 400 x 200 x 80 mm  
**51-140-11** 500 x 270 x 70 mm



Instrumentenkästen  
Instrument boxes  
Cajas para instrumentos  
Scatole per strumenti



**51-142-01** 170 x 90 x 35 mm  
**51-142-02** 200 x 100 x 50 mm  
**51-142-03** 220 x 150 x 50 mm  
**51-142-04** 260 x 150 x 50 mm  
**51-142-05** 310 x 210 x 50 mm

Instrumentenkästen  
Instrument boxes  
Cajas para instrumentos  
Scatole per strumenti



**51-143-18** 180 x 80 x 40 mm  
**51-143-20** 200 x 100 x 60 mm  
**51-143-22** 220 x 120 x 60 mm  
**51-143-25** 250 x 120 x 60 mm  
**51-143-30** 300 x 125 x 60 mm  
**51-143-32** 320 x 150 x 60 mm  
**51-143-50** 500 x 200 x 120 mm

Wattspender, mit Deckel  
Cotton dispenser, with lid  
Dispensadores de algodón, con tapa  
Distributori di cotone, con coperchio



**51-145-01** Ø 50 x 75 mm

Wattspender, ohne Deckel  
Cotton dispenser, without lid  
Dispensadores de algodón, sin tapa  
Distributori di cotone, senza coperchio



**51-145-02** Ø 50 x 75 mm

Wattspender  
Cotton dispenser  
Dispensadores de algodón  
Distributori di cotone



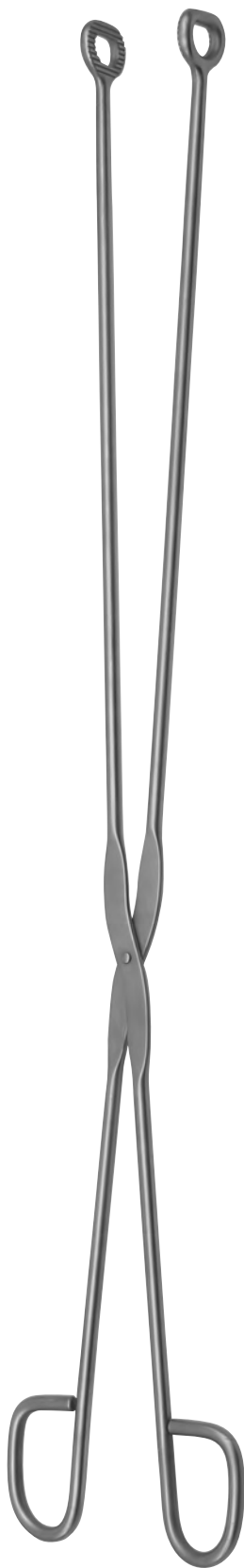
**51-146-01** Ø 50 x 75 mm

Einsatz für 51-146-01  
Insert for 51-146-01  
Insertos para 51-146-01  
Inserto per 51-146-01



**51-146-02** Ø 45 x 55 mm





**MARTIN**

**51-470-58** 58,0 cm, 22 3/4"



**SAUERBRUCH**

**51-474-55** 55,0 cm, 21 1/2"

# 55

Container Systeme

Container Systems

Sistema de Contenedores

Sistema di Contenitori





# 56

Sterilisation

Sterilization

Esterilización

Sterilizzazione



komplett mit perforierter Innendose  
complete with perforated inner box  
completo con caja interior perforada  
completo con scatola interna perforada



**56-100-00** Ø 65 x 15 mm

Innendose, allein  
Inner box, only  
Caja interior, suelta  
Scatola interna, solo



**56-100-65** Ø 62 x 13 mm



**56-102-50** 50 x 25 x 4,5 mm

**56-102-65** 65 x 42 x 8,0 mm

**56-102-75** 75 x 25 x 4,5 mm



**56-110-02** 150 x 95 x 13 mm



**56-112-01** 150 x 95 x 13 mm



**56-112-02** 150 x 95 x 13 mm





### SAUERBRUCH

**56-120-00** 210 x 125 x 17 mm



### SAUERBRUCH

**56-120-01** 210 x 125 x 17 mm

Nadel-Sterilisationsgestell  
Suture needle sterilizing rack  
Soporte para esterilizar las agujas de suture  
Telaio per sterilizzare aghi per sutura



**56-130-00** 13,0 cm, 5 1/8"



**SCHIMMELBUSCH**

56-152-08 - 56-179-59

**56-210-00**

Textilfilter (Paar)  
Textile filters (pair)  
Filtros de tejido (par)  
Filtri di tessuti (paio)



**KONRICH**

56-182-08 - 56-209-59

- 56-152-08 Ø 125 x 80 mm
- 56-152-10 Ø 125 x 100 mm
- 56-152-12 Ø 125 x 125 mm

- 56-155-08 Ø 150 x 80 mm
- 56-155-10 Ø 150 x 100 mm
- 56-155-13 Ø 150 x 130 mm
- 56-155-15 Ø 150 x 150 mm
- 56-155-19 Ø 150 x 190 mm

- 56-159-14 Ø 190 x 145 mm
- 56-159-16 Ø 190 x 165 mm
- 56-159-19 Ø 190 x 190 mm
- 56-159-24 Ø 190 x 240 mm

- 56-164-14 Ø 240 x 145 mm
- 56-164-16 Ø 240 x 165 mm
- 56-164-19 Ø 240 x 190 mm
- 56-164-24 Ø 240 x 240 mm
- 56-164-29 Ø 240 x 290 mm
- 56-164-34 Ø 240 x 340 mm
- 56-164-39 Ø 240 x 390 mm

- 56-182-08 Ø 125 x 80 mm
- 56-182-10 Ø 125 x 100 mm
- 56-182-12 Ø 125 x 125 mm

- 56-185-08 Ø 150 x 80 mm
- 56-185-10 Ø 150 x 100 mm
- 56-185-13 Ø 150 x 130 mm
- 56-185-15 Ø 150 x 150 mm
- 56-185-19 Ø 150 x 190 mm

- 56-189-14 Ø 190 x 145 mm
- 56-189-16 Ø 190 x 165 mm
- 56-189-19 Ø 190 x 190 mm
- 56-189-24 Ø 190 x 240 mm

- 56-194-14 Ø 240 x 145 mm
- 56-194-16 Ø 240 x 165 mm
- 56-194-19 Ø 240 x 190 mm
- 56-194-24 Ø 240 x 240 mm
- 56-194-29 Ø 240 x 290 mm
- 56-194-34 Ø 240 x 340 mm
- 56-194-39 Ø 240 x 390 mm

- 56-169-14 Ø 290 x 145 mm
- 56-169-16 Ø 290 x 165 mm
- 56-169-19 Ø 290 x 190 mm
- 56-169-24 Ø 290 x 240 mm
- 56-169-29 Ø 290 x 290 mm
- 56-169-34 Ø 290 x 340 mm
- 56-169-39 Ø 290 x 390 mm

- 56-174-14 Ø 340 x 145 mm
- 56-174-16 Ø 340 x 165 mm
- 56-174-19 Ø 340 x 190 mm
- 56-174-24 Ø 340 x 240 mm
- 56-174-29 Ø 340 x 290 mm
- 56-174-34 Ø 340 x 340 mm
- 56-174-39 Ø 340 x 390 mm

- 56-179-14 Ø 390 x 145 mm
- 56-179-16 Ø 390 x 165 mm
- 56-179-19 Ø 390 x 190 mm
- 56-179-24 Ø 390 x 240 mm
- 56-179-29 Ø 390 x 290 mm
- 56-179-34 Ø 390 x 340 mm
- 56-179-39 Ø 390 x 390 mm
- 56-179-49 Ø 390 x 490 mm
- 56-179-59 Ø 390 x 590 mm

- 56-199-14 Ø 290 x 145 mm
- 56-199-16 Ø 290 x 165 mm
- 56-199-19 Ø 290 x 190 mm
- 56-199-24 Ø 290 x 240 mm
- 56-199-29 Ø 290 x 290 mm
- 56-199-34 Ø 290 x 340 mm
- 56-199-39 Ø 290 x 390 mm

- 56-204-14 Ø 340 x 145 mm
- 56-204-16 Ø 340 x 165 mm
- 56-204-19 Ø 340 x 190 mm
- 56-204-24 Ø 340 x 240 mm
- 56-204-29 Ø 340 x 290 mm
- 56-204-34 Ø 340 x 340 mm
- 56-204-39 Ø 340 x 390 mm

- 56-209-14 Ø 390 x 145 mm
- 56-209-16 Ø 390 x 165 mm
- 56-209-19 Ø 390 x 190 mm
- 56-209-24 Ø 390 x 240 mm
- 56-209-29 Ø 390 x 290 mm
- 56-209-34 Ø 390 x 340 mm
- 56-209-39 Ø 390 x 390 mm
- 56-209-49 Ø 390 x 490 mm
- 56-209-59 Ø 390 x 590 mm



<b>56-304-01</b>	230 x 130 mm
<b>56-304-02</b>	260 x 150 mm
<b>56-304-03</b>	275 x 325 mm
<b>56-304-04</b>	300 x 200 mm
<b>56-304-05</b>	325 x 275 mm
<b>56-304-06</b>	475 x 175 mm

Ersatz-Textilfilter (10 Stück)  
 Spare textile filters (10 pcs.)  
 Filtros de tejido de recambio (10 p.)  
 Filtri di tessuto di ricambio (10 pezzi)



Deckel gelocht | Boden gelocht  
 Lid perforated | Bottom perforated  
 Tapa perforado | Fondo perforado  
 Coperchio perforato | Fondo perforato

<b>56-300-01</b>	230 x 130 x 50 mm
<b>56-300-02</b>	260 x 150 x 50 mm
<b>56-300-03</b>	275 x 325 x 50 mm
<b>56-300-04</b>	300 x 200 x 50 mm
<b>56-300-05</b>	325 x 275 x 50 mm
<b>56-300-06</b>	420 x 175 x 50 mm

<b>56-302-01</b>	230 x 130 x 75 mm
<b>56-302-02</b>	260 x 150 x 75 mm
<b>56-302-04</b>	300 x 200 x 75 mm
<b>56-302-05</b>	325 x 275 x 75 mm
<b>56-302-06</b>	420 x 175 x 75 mm

**56-300-01 - 56-302-06**



<b>56-220-25</b>	25,0 cm, 9 3/4"
<b>56-220-32</b>	32,0 cm, 12 1/2"



<b>56-306-20</b>	200 x 100 x 25 mm
<b>56-306-23</b>	230 x 130 x 25 mm

Sterilisier- und Lagerungsgestell, für 8 Mikro-Rundgriff-Instrumente bis 17 cm Länge.  
 Rack for sterilisation and storage, for 8 micro surgery instruments up to 17 cm long with round handles.  
 Bastidor para esterilizar y conservar, para 8 micro instrumentos con mangos redondos hasta 17 cm de largo.  
 Supporto per sterilizzazione e conservazione, per 8 microstrumenti con manico rotondo fino a 17 cm di lunghezza.



<b>56-322-08</b>	190 x 96 x 30 mm
------------------	------------------

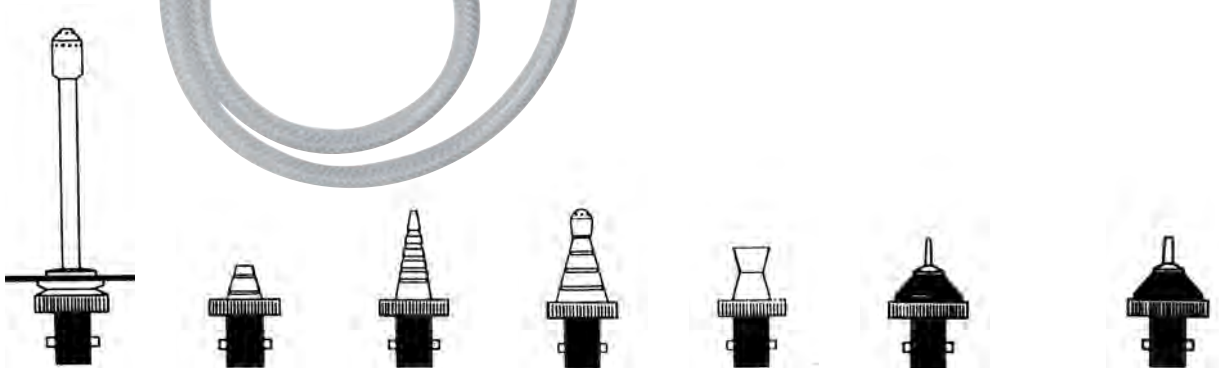


**56-900-00 SET**

komplett, mit 9 Aufsätzen 56-900-01 – 56-900-09, 1 m Druckschlauch  
 complete, with 9 tips 56-900-01 – 56-900-09, 1 m pressure tube  
 completo, con 9 toberas 56-900-01 – 56-900-09, 1 m tubo de presión  
 completa, con 9 raccordi 56-900-01 – 56-900-09. 1 m tubo ad alta pressione

**56-900-20**

Wasserstrahl-Reinigungspistole, allein  
 Water jet pistol, only  
 Pistola-lavatoria de chorro de agua, suelta  
 Pistola lavatrice a getto d'acqua, solo



**56-900-01**

für Flaschen  
 for bottles  
 para botellas  
 per bottiglie

**56-900-02**

für Record Spritzen  
 for Record syringes  
 para jeringas Record  
 per siringhe Record

**56-900-03**

für Katheter  
 for catheters  
 para catéteres  
 per cateteri

**56-900-04**

für Drainageschläuche  
 for drainage tubes  
 para tubos de drenaje  
 per tubi di drenaggio

**56-900-05**

für Hohlgefäße  
 for receptacles  
 para recipientes  
 per recipienti

**56-900-06**

für Record Kanülen  
 for needles with Record-cone  
 para agujas con cono Record  
 per aghi con cono Record

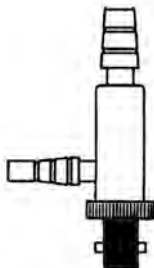
**56-900-07**

für Luer Kanülen  
 for needles with Luer-cone  
 para agujas con cono Luer  
 per aghi con cono Luer



**56-900-08**

für Pipetten  
 for pipettes  
 para pipetas  
 per pipette



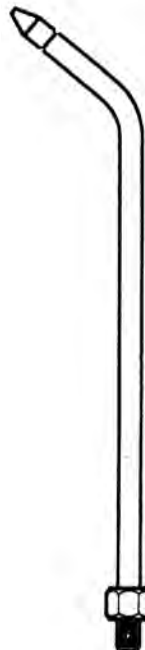
**56-900-09**

für feine Pipetten  
 for fine pipettes  
 para pipetas finas  
 per pipette fini



**56-900-10**

für Reinigungsaufsatz  
 for cleaning tip  
 para tobera de limpieza  
 per lavaggio



**56-900-11**

für Reinigungsaufsatz  
 for cleaning tip  
 para tobera de limpieza  
 per lavaggio



**56-900-12**

Überwurfmutter 1/2 "   
 Coupling 1/2 "   
 Tuerca-hembra 1/2 "   
 Dado premistoppa 1/2 "



**56-900-13**

Überwurfmutter 3/4 "   
 Coupling 3/4 "   
 Tuerca-hembra 3/4 "   
 Dado premistoppa 3/4 "



Handwaschbürste, sterilisierbar  
 Nailbrush, autoclavable  
 Cepillo de uñas, sterilizable  
 Spazzola per unghie, sterilizzabile



**56-911-01**



Reinigungsbürste  
 Cleaning brush  
 Cepillo de limpieza  
 Spazzole per pulire

**56-912-95** 210 x 95 mm



**56-915-00** 500 ml

Instrumenten Pflegemittel  
 Instrument care lubricant  
 Detergente para instrumentos  
 Detergente per strumenti



**56-920-00** 1 x 5 l

**56-920-01** 4 x 5 l





# 60

Motorensysteme

Motor Systems

Sistema de motor

Sistema di motore









# 70

Hochfrequenz Chirurgie

High Frequency Surgery

Cirugía de alta frecuencia

Chirurgia ad alta frequenza







**72**

Endoskope

Endoscopes

Endoscopios

Endoscopi





**AMNOTEC**  
INTERNATIONAL MEDICAL



Inhaltsverzeichnis

Index of contents

Indice alfabético

Indice alfabetico



<b>A</b>			
Abfallzangen	1218	Atriumhaken	816
<b>ABRAHAM</b> Tonsillenfasszangen	621	<b>AUFRICHT</b> Nasenhaken	687
<b>ABRAHAM</b> Tonsillennmesser	57	<b>AUFRICHT</b> Nasenraspeln	1085, 1090
Absaugküretten	914	<b>AUFRICHT</b> Scheren für die plastische Chirurgie	115
Abszessmesser	57	Autopsie-Besteck	1021
Abziehstein	58	<b>AUVARD</b> Scheidenspekulas	895
<b>ADLERDYCE</b> Elevatorien	1055	<b>AYRE</b> Konisationsmesser	56
<b>ADLERKREUTZ</b> Gefäß- und Tumorzangen	214	<b>B</b>	
<b>ADSON</b> Saugrohre	78	<b>BABCOCK</b> Darm- und Gewebefasszangen	362, 363
<b>ADSON</b> Anatomische Pinzetten	198, 199	<b>BABINSKY</b> Perkussionshammer	17
<b>ADSON</b> Anatomische TC Pinzetten	232	<b>BABY-ADSON</b> Präparier- und Ligaturklemmen	269
<b>ADSON</b> Arterienklemmen	245, 256	<b>BABY-ALLIS</b> Darm- und Gewebefasszangen	363
<b>ADSON</b> Bohrführungsinstrumente	1012	<b>BABY-COLLIN</b> Bauchdeckenhalter	466
<b>ADSON</b> Chirurgische Pinzetten	209, 210	<b>BABY-CRILE</b> Arterienklemmen	248, 257
<b>ADSON</b> Chirurgische TC Pinzetten	234	<b>BABY-CRILE-WOOD</b> TC Nadelhalter	523
<b>ADSON</b> Durahaken	554, 555	<b>BABY-KOCHER</b> Darmklemmen	844
<b>ADSON</b> Hohlmeißelzangen	1131	<b>BABY-MIKULICZ</b> Peritoneumklemmen	277
<b>ADSON</b> Nadelhalter	489	<b>BABY-MIXTER</b> Präparier- und Ligaturklemmen	270
<b>ADSON</b> Raspatorien	1059	<b>BABY-MOSQUITO</b> Arterienklemmen	251
<b>ADSON</b> Reibahlen	1012	<b>BABY-OVERHOLT</b> Präparier- und Ligaturklemmen	270
<b>ADSON</b> Wundspreizer, selbsthaltend	453, 455, 458-461	<b>BABY-ROUX</b> Wundhaken	416
<b>ADSON-BIEMER-MICRO</b> Chirurgische Pinzetten	211	<b>BABY-SATINSKY</b> Vena-Cava-Klemmen	347
<b>ADSON-BROWN</b> Chirurgische Pinzetten	217	<b>BABY-TISCHLER</b> Uterus-Biopsiezangen	921
<b>ADSON-BROWN</b> Chirurgische TC Pinzetten	235	<b>BABY-YANKAUER</b> Saugrohre	81
<b>ADSON-DE BAKEY</b> Atraumatische Pinzetten	218	<b>BACKHAUS</b> Tuchklemmen	367
<b>ADSON-GRAEFE</b> Chirurgische Pinzetten	217	<b>BACKHAUS-KOCHER</b> Tuchklemmen	367
<b>ADSON-MICRO</b> Anatomische Pinzetten	199	<b>BACON</b> Hohlmeißelzangen	1129
<b>ADSON-MICRO</b> Anatomische TC Pinzetten	232	<b>BAGDLEY</b> Laminektomie-Wundsperrerr	559
<b>ADSON-MICRO</b> Chirurgische Pinzetten	210, 211	<b>BAILEY</b> Laminektomie-Zangen	1007
<b>ADSON-MICRO</b> Chirurgische TC Pinzetten	234	<b>BAILEY-GIBBON</b> Rippenkontraktoren	800
<b>ADSON-MINI</b> Chirurgische Pinzetten	210	<b>BAINBRIDGE</b> Arterienklemmen	246
<b>AGNEW</b> Parazentesenadel	736	<b>BAINBRIDGE</b> Atraumatische Gefäßklemmen	314
<b>ALAN-PARKS</b> Analspreizer	865	<b>BAKES</b> Gallenkanaldilatatore	872
<b>ALDINGER</b> Knochenheber	1081	<b>BALFOUR</b> Bauchdeckenhalter	470
<b>ALEXANDER</b> Flachmeißel	1030	<b>BALFOUR</b> USA Bauchdeckenhalter	471
<b>ALEXANDER</b> Hohlmeißel	1030	<b>BALFOUR</b> Wundhaken	485
<b>ALEXANDER</b> Raspatorien	1065	<b>BALFOUR-BABY</b> Bauchdeckenhalter	469
<b>ALEXANDER</b> Uterus-Biopsiezangen	920	<b>BALL &amp; SOCKET</b> Tuchklemmen	368
Algesimeter (Nervrädchen)	20	<b>BALLENGER</b> Schwingmesser	679
Algesimeter mit Nadel und Pinsel	20	<b>BALLENGER</b> Septum-Hohlmeißel	679
<b>ALLEN</b> Darmklemmen	844	<b>BALLENGER</b> Tonsillenfasszangen	621
<b>ALLIS</b> Darm- und Gewebefasszangen	363, 364	<b>BALLENGER-HAJEK</b> Septum-elevatorien	676
<b>ALLIS-ADAIR</b> Darm- und Gewebefasszangen	365	<b>BARANY</b> Lärmtrommel	716
<b>ALLISON</b> Lungenspatel	800	<b>BARBARA</b> Mikro-Nadel	748, 749
<b>ALM</b> Wundspreizer, selbsthaltend	446	<b>BARNES</b> Saugrohre	88
<b>ALY</b> Algesimeter	20	<b>BARNHILL</b> Ringmesser	629
Aminoskope	864	<b>BARON</b> Saugrohre	88
Amniotom	903	<b>BARR</b> Analspreizer	861
Amputations- und Resektionssägen	1009, 1010	<b>BARRAQUER</b> Cilienpinzetten	223
Amputationsmesser	52	<b>BARRAQUER</b> Mikro-Scheren	140
Amputationsretraktoren	1008	<b>BARRON</b> Hämorrhoidal-Ligatore	867
Analsonden	866	<b>BARSKY</b> Wundhaken	442
Analspreizer	861, 864-866	<b>BARTH</b> Ohrküretten	730
Anastomoseklemmen	845	<b>BARTH</b> Scharfe Löffel	1092
Anatomische Pinzetten	194-204	Batterie-ladegerät	42
Anatomische Skalpelle	51	Bauch- und Darmspatel	421
<b>ANDERSON-ADSON</b> Wundspreizer, selbsthaltend	453	Bauchdeckenhalter	465-477
<b>ANESTOPHONE</b> Stethoskop	19	Bauchdeckenscheren	97, 98
<b>ANKENEY</b> Rippenspererr	774, 783	<b>BAUMGARTNER</b> Drahtzangen	1159
Anlegezange für Bulldogklemmen	293, 296	<b>BAYHA</b> Skalpellgriffe	44
Antrumhäkchen	747	<b>BAYONET-KERRISON</b> Laminektomie-Stanzen	968-975
Antrumstanzen	693-695	<b>BEACHAM</b> Amniotom	903
Anuskope	862, 863	<b>BEALE</b> Häkchen	748
<b>ANVIL</b> Nagelzangen	1206	<b>BEALES</b> Sehnenmesser	745
Aorta-Dilatatore	810	<b>BECK</b> Laminektomie-Zangen	994
Aortahaken	816, 817	Beckenzirkel	931
Aortastanzen	811	<b>BECKMANN</b> Nasenspekulas	662
<b>ARKANSAS</b> Abziehstein	58	<b>BECKMANN</b> Ringmesser	628
Arm-System	478, 479	<b>BECKMANN</b> Wundspreizer, selbsthaltend	459
<b>ARRUGA</b> Nadelhalter	496	<b>BECKMANN-ADSON</b> Wundspreizer, selbsthaltend	462
<b>ARRUGA</b> TC Nadelhalter	531	<b>BECKMANN-EATON</b> Wundspreizer, selbsthaltend	463
Arterienklemmen	238-260	<b>BEEBEE</b> Drahtscheren	148
Abdominal KIT II	481	<b>BEER</b> Cilienpinzetten	223
<b>ASCH</b> Sekretlöffel	911	<b>BEESON</b> Gipsspreizer	1193
<b>ASH</b> Septumzangen	698	Behälter	1212-1217
Ästhesiometer	20	Beinhautmesser	53
Atraumatische Gefäßklemmen	299-346	<b>BELLUCCI</b> Mikro-Ohrscherchen	740
Atraumatische Pinzetten	218-220	<b>BENNETT</b> Knochenheber	1082
Atrial Blatt Einführungs-zange	820	<b>BENGOLEA</b> Arterienklemmen	243, 255
Atrial Blätter	820	<b>BENSAUDE</b> Anuskope	862
Atrial Blatthalter	820	<b>BENSON</b> Darmklemmen	852
Atrial Haken	792, 797, 824	Bereitschaftskästen	1225
		<b>BERGER</b> Uterus-Biopsiezangen	920



<b>BERGMANN</b> Anatomische Skalpelle	51	<b>BROWN</b> Gewebefasspinzetten	217
<b>BERGMANN</b> Gipssägen	1195	<b>BROWN</b> Nadelhalter	490
<b>BERGMANN</b> Hämmer	1015	<b>BRUENINGS</b> Broncho-Oesophagoskopiezangen	637
<b>BERGMANN</b> Verband- und Gipsscheren	1190	<b>BRUENINGS</b> Ohrclupen	727
<b>BERGMANN</b> Wundhaken	434	<b>BRUENINGS</b> Septummesser	672
<b>BERLIN</b> Biopsieküretten	913	<b>BRUENINGS</b> Septumzangen	697
<b>BERLIN</b> Schlauchklemmen	370	<b>BRUENINGS</b> Tonsillennmesser	57
<b>BERLINER</b> Perkussionshämmer	16	<b>BRUENINGS</b> Tonsillenschnürer	623
<b>BERNHARD</b> Tuchklemmen	368	<b>BRUENINGS</b> Verlängerungsrohre	636
Bertillon Messzirkel	20	<b>BRUENINGS</b> Zungenspatel	600
Beschneidungsinstrumente	956	<b>BRUENINGS-BRUNK</b> Nasenhaken	687
<b>BETHUNE</b> Rippenscheren	765	<b>BRUENINGS-LUCAS</b> Flachmeißel	1029
<b>BEYER</b> Hohlmeißelzangen	1130, 1133	<b>BRUENINGS-LUCAS</b> Hohlmeißel	1029
Biegeinstrumente	1170	<b>BRUNETTI</b> Meißel	1049
<b>BIEMER</b> Gefäßspreizer	827	<b>BRUNNER</b> Führungshohlsonden	509, 511
<b>BILL</b> Zughebel	936	<b>BRUNNER</b> Rektum-Anastomoseklemmen	855
<b>BILLEAU</b> Ohrschlingen	729	<b>BRUNNER</b> Rippenscheren	768
Biopsieküretten	912-914	<b>BRUNNER</b> Unterbindungsnadeln	502, 509
Biopsienasenzangen	755	<b>BRUNNER</b> Wundhaken	396-398, 415
<b>BIRCHER</b> Meniskus- und Knorpelfaßzangen	1145	<b>BRUNS</b> Scharfe Löffel	1095, 1106, 1107
<b>BIRCHER</b> Meniskussmesser	1147	<b>BRUNS</b> Verband- und Gipsscheren	1190, 1191
<b>BIRCHER</b> Wund- und Meniskushaken	1148	Bruststütze	638
<b>BIRCHER-GANSKE</b> Meniskus- und Knorpelfaßzangen	1145, 1146	Bruststütze für alle Mundsperrer	617
<b>BIRKETT</b> Arterienklemmen	249	<b>BRYANT</b> Kornzangen	352
<b>BLAKE</b> Gallensteinzangen	877	<b>BUCHWALD</b> Zungenspatel	600
<b>BLAKESLEY</b> Nasenzangen	757	<b>BUCK</b> Fremdkörperzängchen	731
<b>BLAKESLEY-WIGAND</b> Nasenzangen	991	<b>BUCK</b> Ligaturscheren	147
Blasenhalsspreizer	953	<b>BUCK</b> Myringotom	735
Blasenspatel	953	<b>BUCK</b> Ohrküretten	728
Blasenspreizer	952	<b>BUCK</b> Perkussionshammer	16
Blattosteotome	1035	<b>BUCK-GRAMCKO</b> Knochenhebel	1075
Bleihände	1182	<b>BUECHS</b> Raspatorien	1063
<b>BLOHMKE</b> Tonsillenfasszangen	621	<b>BUELAU</b> Trokare	70
<b>BLOUNT</b> Wund- und Meniskushaken	1149	Bulldogklemmen	288-297
<b>BLUMENTHAL</b> Hohlmeißelzangen	1128	<b>BUMM</b> Polypen und Ovarienzangen	356
Blutdruckmessgeräte	24-25	<b>BUMM</b> Uterusküretten	928, 929
Blutschnäpper	29	<b>BUNNELL</b> Handbohraparate	1172
<b>BOEHLER</b> Hohlmeißelzangen	1132	<b>BUNNELL</b> Sehenschäler	1152, 1153
<b>BOEHLER</b> Knochensplitterzangen	1142	<b>BUNT</b> Sterilisierklammern	372
<b>BOERMA</b> Geburtszangen	934	<b>BURFORD</b> Rippensperrer	775-777
<b>BOETTCHER</b> Tonsillenscheren	116	<b>BURKE</b> Uterus-Biopsiezangen	920
Bohrführungsinstrumente	1012	<b>BUSCH</b> Nabelschnurschere	102
Bohrhandgriffe	1156, 1157	<b>BUSHE</b> Scharfe Löffel	1113
<b>BOIES</b> Nasenfraktur Elevatorien	698	<b>C</b>	
<b>BONACCOLTO</b> Nahtpinzetten	198	<b>CAIRNS</b> Arterienklemmen	251
<b>BONN</b> Feine chirurgische Scheren	129	<b>CANADIAN</b> Meniskussmesser	1147
<b>BONN</b> Mikropinzetten	227	<b>CAPLAN</b> Septumscheren	700
<b>BONNEY</b> Anatomische Pinzetten	203	<b>CARDIOBASE</b> Rippensperrer	798, 799
<b>BONNEY</b> Anatomische TC Pinzetten	233	<b>CARDIOPHONE</b> Stethoskop	19
<b>BONNEY</b> Chirurgische Pinzetten	215	<b>CARMALT</b> Splitterpinzetten	225
<b>BONNEY</b> Chirurgische TC Pinzetten	235	<b>CAROLL</b> Finger-Goniometer	20
<b>BONNEY</b> Darm- und Gewebefaßzangen	360	<b>CAROLL</b> Sehnedurchziehungen	1151
<b>BOROWSKI</b> Aortahaken	817	<b>CARPENTER</b> Tonsillendissektoren	622
<b>BOSE</b> Trachealhäkchen	655	<b>CARPENTER</b> Tonsillennmesser und Enukeator	622
<b>BOSE</b> Wundspreizer, selbsthaltend	445	<b>CARREL</b> Arterienklemmen	251
<b>BOUCHERON</b> Ohrspekulas	723	<b>CASPAR</b> Cervicale Wirbelkörperdistractionssystem	560, 561
<b>BOWLES</b> Stethoskop	18	<b>CASPAR</b> Dissektor	832, 833
<b>BOWMAN</b> Tränenkanalsonden	62	<b>CASPAR</b> Explorations- & Koagulationshäkchen	834
<b>BOYNTON</b> Nadelhalter	497	<b>CASPAR</b> Fadengabel	828
<b>BOYS-ALLIS</b> Darm- und Gewebefaßzangen	365	<b>CASPAR</b> Küretten	1110
<b>BOZEMANN</b> Gefäßschere	131	<b>CASPAR</b> Laminektomie-Spreizer	564-567
<b>BOZEMANN</b> Nadelhalter	493	<b>CASPAR</b> Laminektomie-Zangen	987, 1000-1004
<b>BOZEMANN</b> Tamponzangen	353	<b>CASPAR</b> Laminektomie-Zangen, zerlegbar	1002, 1003
<b>BOZEMANN</b> TC Nadelhalter	526	<b>CASPAR</b> Messschieber	559
<b>BOZEMANN-DOUGLAS</b> Tamponzangen	353	<b>CASPAR</b> Nervwurzelhaken	552
<b>BRAND</b> Sehnedurchziehungen	1152	<b>CASPAR</b> Raspatorien	562, 563
<b>BRAUN</b> Dekapitationshaken	937	<b>CASPAR</b> Scharfe Löffel	1101-1103
<b>BRAUN</b> Hakenzangen	901, 908	<b>CASPAR</b> Skalpellgriffe	825
<b>BRAUN</b> Kranioklast	938	<b>CASPAR</b> Spekulas für lumbale Bandscheibenoperationen	585
<b>BRAUN</b> Scheidenspekulas	892	<b>CASPAR</b> Stößel	1024
<b>BRAUN</b> Uterus-Depressor	900	<b>CASPAR</b> Wundhaken	388
<b>BRAUN-STADLER</b> Damm Scheren	101	<b>CASPAR</b> Wundspreizer für die cervicale Wirbelsäule	568-579
<b>BRAUN-STADLER</b> Episiotomie Scheren	101	<b>CASPAR</b> Wundspreizer für die lumbale Wirbelsäule	582, 584
<b>BREISKY</b> Scheidenspekulas	894	<b>CASTANEDA</b> Neonatal-Gefäßklemmen	298-299
<b>BREISKY WIENER</b> Scheidenspekulas	894	<b>CASTANEDA</b> Rippensperrer	773, 774
<b>BRIDGE</b> Präparier- und Ligaturklemmen	264	<b>CARSTENS</b> Trokare	70
<b>BRODIE</b> Hohlsonden	64	<b>CASTROVIEJO</b> Klängenbrecher	47
<b>BROM</b> Wundhaken	431	<b>CASTROVIEJO</b> Klängenhalter	47
Broncho-Oesophagoskopiezangen	636	<b>CASTROVIEJO</b> Mikropinzetten	226
Bronchoskopie	658, 659	<b>CASTROVIEJO</b> Mikro-Scheren	138, 139
Bronchusklemmen	802	<b>CASTROVIEJO</b> Tränenkanalsonden	63
<b>BROPHY</b> Anatomische Pinzetten	202	<b>CATLIN</b> Amputationsmesser	52
<b>BROPHY</b> Chirurgische Pinzetten	214	<b>CAWOOD-MINNESOTA</b> Lippen- und Wangenhalter	618



Cerclage-Instrumente	1158	CORWIN Drahtzangen	1160
Cerlage Draht	1157	CORYLLOS Rippenscheren	766
Cervicales Wirbelkörperdistractionssystem	560, 561	CORYLLOS Wundhaken	395
CHADWICK Feine chirurgische Scheren	123	COTTLE Columellapinzette	686
CHAPUT Darm- und Gewebefäßzangen	366	COTTLE Fixierpinzette	686
CHARNLEY Bauchdeckenhalter	475	COTTLE Flachmeißel	680, 681
CHARRIÈRE Amputations- und Resektionssägen	1009	COTTLE Hämmer	1013
CHEATTLE Sterilisierzangen	1209	COTTLE Knorpelquetsche	686
CHELSEA Proktoskope	862	COTTLE Nasenflügelhäkchen	688, 689
CHERON Tupferzangen	354	COTTLE Nasenhaken	690
CHEVALIER Rippensperrer	781	COTTLE Nasenplastikmesser	673
CHEVALIER-JACKSON Tracheal-Kanülen	655	COTTLE Nasenraspeln	1084
CHILDE Wundklammerpinzetten	517	COTTLE Nasenscheren	120, 122
Chirurgische Nadeln	514-516	COTTLE Nasenspekulas	666-668
Chirurgische Pinzetten	205-218	COTTLE Osteotome	680, 1031
Chirurgische Scheren	91-97, 103-105, 151-153	COTTLE Raspatorien	1060
Chirurgische SCT Scheren	186, 187	COTTLE Septumlevatorien	677, 678
Chirurgische TC Scheren	162, 165, 167	COTTLE TC Tonsillenscheren	174
CHURCH Gefäßscheren	132	COTTLE-KAZANJIAN Knochensplitterzangen	1141
Cilienpinzetten	223	COTTLE-KNAPP Nasenscheren	122
CINELLI Osteotome	683	COTTLE-MASING Nasenscheren	122
CITELLI Laminektomie-Stanzen	958	COTTLE-NEIVERT Nasenflügelhäkchen	689
CITELLI-BEYER Laminektomie-Stanzen	958	COTTLE-WALSHAM Septumzangen	698, 699
CLAR Stirnlampen	26	COUPLAND Saugrohre	82
CLASSON Gefäßscheren	132	CRAFOORD Gynäkologische Scheren	101
CLAUS V. EICKEN Tonsillennadel	626	CRAFOORD Präparier- und Ligaturklemmen	266
CLEVELAND Hohlmeißelzangen	1128	CRAFOORD-SELLORS Präparier- und Ligaturklemmen	266
CLEVELAND Knochensplitterzangen	1141	CRAIG Septumzangen	696
CLOVER Tonsillenfasszangen	620	CREDO Hornhauthobel	1207
CLOWARD Laminektomie-Zangen	1006	CRILE Arterienklemmen	248, 258
CLOWARD Nervwurzelhaken	553	CRILE Nadelhalter	497
CLOWARD Wirbelkörperspreizer	592, 593	CRILE Wundhaken	419, 430
CLOWARD Wundspreizer für die cervicale Wirbelsäule	580, 581	CRILE-MURRAY Nadelhalter	490
COAKLEY Kieferhöhlenküretten	690-692	CRILE-RANKIN Arterienklemmen	246, 257
COAKLEY Kieferhöhlentrokar	71	CRILE-WOOD Nadelhalter	490
COBB Elevatorien	1072, 1073	CRILE-WOOD TC Nadelhalter	522
COBB Küretten	1112	CRUTCHFIELD Schädelhalter	548
COBB Spinal Hohlmeißel	1050	CUSCO Scheidenspekulas	880-882
COBETT Dermatome	59	CUSHING Anatomische Pinzetten	202
COBRA Atraumatische Gefäßklemmen	318	CUSHING Anatomische TC Pinzetten	233
COEN Uterus Känule	915	CUSHING Chirurgische Pinzetten	213
COHEN Raspatorien	1055	CUSHING Durahaken	555
COLCLOUGH Laminektomie-Stanzen	984	CUSHING Hirnspatel	543
COLLER Arterienklemmen	246	CUSHING Laminektomie-Zangen	995, 998
COLLIER Nadelhalter	492	CUSHING Wundhaken	430, 437, 441, 444
COLLIN Bauchdeckenhalter	466, 467	CUSHING-BROWN Chirurgische Pinzetten	216
COLLIN Beckenzirkel	931	CUSHING-KOCHER Wundhaken	437
COLLIN Darm- und Gewebefäßzangen	361	CUSHING-LANDOLT Spekulas für Hypophysektomie	702
COLLIN Dynamometer	20	CUZZI Plazenta- und Abortuslöffel	942
COLLIN Hämmer	1016	CZERNY Analspreizer	861
COLLIN Kornzangen	354	CZERNY Hakenzangen	906
COLLIN Nabelschnurklemmen	937	CZERNY Wundhaken	420
COLLIN Organfasszangen	358	<b>D</b>	
COLLIN Scheidenspekulas	880	DAHLGREN Schädelzangen	549
COLLIN Skalpgriffe	47	DAHMEN Hohlmeißel	1051
COLLIN Uterusfaßzangen	910	DAHMEN Osteotome	1051
COLLIN Wundhaken	420	DALE Atraumatische Gefäßklemmen	329
COLLIN Wundklammerzangen	518	Damm Scheren	101, 102, 152
COLLIN Zungenzangen	618	Damm TC Scheren	162
COLLIN-DUVAL Fasspinzette	204	DANDY Arterienklemmen	249, 258
COLLIN-HARTMANN Wundhaken	416	DANDY Durahaken	554
COLLIN-LOKTITE Bauchdeckenhalter	467	DANDY Gefäßscheren	132
COLLYER Beckenzirkel	931	DARDIK Atraumatische Gefäßklemmen	346
Columellapinzette	686	DARLING Wundspreizer, selbsthaltend	452
CONE Ringküretten	1111	Darm- und Gewebefäßzangen	360-366
CONE Schädelzangen	549	Darm- und Magenklemmen	860
CONVERSE Nasenflügelhäkchen	688	Darmklemmen	844-854
CONVERSE Nasenhaken	687	Darmscheren	103
CONVERSE Nasenplastikmesser	673	DARTIGUES Uterusfaßzangen	909
CONVERSE Osteotome	682	DAUBENSPECK Scharfe Löffel	1099
COOLEY Aorta-Dilatatoren	810	DAUTREY-MUNRO Osteotome	1034
COOLEY Atraumatische Gefäßklemmen	304, 305, 326, 330, 335-339, 342-345	DAVIDSON Wundhaken	411
COOLEY Atraumatische Pinzetten	219, 220	DAVIS Intimaspatel	813
COOLEY Atrial Haken	797	DAVIS Sterilisierzangen	1209
COOLEY Atriumhaken	816	DAVIS-BOYLE Mundsperrer	608-612
COOLEY Gefäßdilatatoren	808	DAVIS-BOYLE Zungendrucker	616
COOLEY Rippensperrer	769-771, 788, 789	DAVIS-MEYER Mundsperrer	607
COOLEY Saugrohre	83	DAVIS-MEYER Zungendrucker	616
COOLEY-BECK Atraumatische Gefäßklemmen	340	DAY Ohrhäkchen	731
COOLEY-LEITZ Atraumatische Gefäßklemmen	340	DE BAKEY Atraumatische Gefäßklemmen	300-303, 309-311, 313, 314, 316, 317, 321, 322, 325, 328, 330
COOPER Unterbindungsnadeln	502	DE BAKEY Atraumatische Pinzetten	219, 220
COPE Wundhaken	440	DE BAKEY Atraumatische TC Pinzetten	236
CORDES Broncho-Oesophagoskopiezangen	637		





DE BAKEY Bulldogklemmen	288, 289
DE BAKEY Gefäßdilatoren	809
DE BAKEY Gefäßscheren	134, 135
DE BAKEY Präparierscheren	115
DE BAKEY Rippensperrerr	786, 787
DE BAKEY Saugrohre	84
DE BAKEY TC Gefäßscheren	179
DE BAKEY TC Nadelhalter	522, 523
DE BAKEY Wundspreizer, selbsthaltend	464
DE BAKEY-BAHNSON Atraumatische Gefäßklemmen	310
DE BAKEY-BECK Atraumatische Gefäßklemmen	305
DE BAKEY-CAROTIS Bulldogklemmen	297
DE BAKEY-DIETHRICH Bulldogklemmen	294
DE BAKEY-MIXTER Atraumatische Gefäßklemmen	300
DE BAKEY-MOSQUITO Atraumatische Gefäßklemmen	307
DE BAKEY-PEAN Atraumatische Gefäßklemmen	306
DE BAKEY-RANKIN Atraumatische Gefäßklemmen	307
DE BAKEY-RUMEL Atraumatische Gefäßklemmen	300
DE BAKEY-SATINSKY Atraumatische Gefäßklemmen	331
DE BAKEY-SATINSKY Bulldogklemmen	297
DE LEE Geburtszangen	932
DE MARTEL Einführungsinstrumente	549
DE MARTEL-WOLFSON Anastomoseklemmen	845
DE MARTEL-WOLFSON Klemmenhalter	845
DE MARTEL-WOLFSON Klemmenschließzange	845
DE VILBISS Schädelzangen	549
DEAN TC Tonsillenscheren	174
DEAN Tonsillenscheren	116
DEAVER Chirurgische Scheren	96
DEAVER Wundhaken	426, 427, 485
DECKER Laminektomie-Zangen	1006
Deckglaspinzetten	226
DEJERINE Perkussionshämmer	16
Dekapitationshaken	937
DEMEL Cerclage-Instrumente	1158
DEMEL Drahtumführungsadeln	1158
DENHARDT Mundsperrerr	603
DENNIS-BROWNE Bauchdeckenhalter	471
DENNIS-BROWNE Gewebefasspinzetten	204
DERF (WRIGHT) Nadelhalter	491
DERF TC Nadelhalter	525
DERF-CONVERSE Nadelhalter	492
DERF-CONVERSE TC Nadelhalter	525
Dermatologie	60, 61
Dermatome	59
DERRA Atraumatische Gefäßklemmen	304
DESCHAMPS Unterbindungsnadeln	503-508
DESJARDINS Gallensteinlöffel	873
DESJARDINS Gallensteinsonden	872
DESJARDINS Gallensteinzangen	878
DESJARDINS Nierenstielklemmen	282
DESMARRES Wundhaken	436
Diagnostik Bestecke	30-35
DICK Hysterektomieklammern	276
DIEFFENBACH Bulldogklemmen	292
DIETER Hammerkopfstangen	744
DIETRICH Bulldogklemmen	291
DIETRICH Atraumatische Gefäßklemmen	334
DIETRICH-VASCULAR TC Nadelhalter	532
Dilatationsbougies	949, 950
DINGMANN Knochenhaltezeuge	1117
DINGMANN Mundsperrerr	606
DINGMANN Zungendrucker	615
DIPLOMAT Blutdruckmessgeräte	25
Dissektomie-Spreizer	594
Dissektoren	703, 708, 753, 831, 832, 835, 840, 1052, 1056
Distractionsklammer für Knochenhalteklammern	1126
Diszisionsmesser	745
DITTEL Katheterspanner	947
DIXON-LOVELACE Arterienklemmen	247, 257
DOCKHORN Wundhaken	387
Doppelsonden	827
Dosen	1214
DOUAY Uterus-Biopsiezangen	920
DOUGHTY Zungendrucker	615
DOUGLAS Cilienpinzetten	223
DOUGLAS Kieferhöhlentroker	71
DOYEN Bauchdeckenhalter	480
DOYEN Bauchdeckenscheren	97, 98
DOYEN Darmklemmen	844-847
DOYEN Hohlsonden	63
DOYEN Myomheber	908
DOYEN Nadelhalter	492

DOYEN Polypen und Ovarienzangen	356
DOYEN Raspatorien	1066, 1067
DOYEN Scheidenspekulas	893
DOYEN Tuchklemmen	368
DOYEN Wundhaken	402
DOYEN Zungendrucker	602
DOYEN-CHILD Bauchdeckenhalter	480
DOYEN-COLLIN Mundsperrerr	603
DOYEN-JANSEN Mundsperrerr	603
DOYEN-STILLE Wundhaken	408
DRAFFIN Halterahmen für Mundsperrerr	617
Drahtgeflecht	1155
Drahtkneifzangen	1164-1170
Drahtsägen	1010
Drahtscheren	148
Drahtumführungsadeln	1158, 1159
Drahtzangen	1159-1163
DUBOIS Kephalotomieschere	100
DUEHRSEN Anatomische Pinzetten	203
DUEHRSEN Chirurgische Pinzetten	215
DUKE Trokare	71
DUNN-DAUTREY Osteotome	1026
DUPLAY Hakenzangen	902
DUPLAY Kornzangen	351, 352
DUPLEX Stethoskope	18
DUPUY-WEISS Unterbindungsnadeln	626
Dura-Dissektoren	550, 551, 812, 813
Durahaken	554, 555
Duramesser	57, 58, 553
DURANTE Gefäß- und Tumorzangen	218
DUVAL Darm- und Gewebefasszangen	360, 361
DUVAL Fasspinzetten	204
DUVAL-COLLIN Darm- und Gewebefasszangen	361
Dynamometer	20
<b>E</b>	
ECHLIN Hohlmeißelzangen	1135
EDER Watteträger	66
EICKEN Kieferhöhlenspülkanülen	88
Einführungsinstrumente	549
Einführungszängchen für Teflonprothesen	742
Einmal-Skalpelle	49
EISELSBERG Ligaturscheren	147
EISELSBERG Nadelhalter	497
Elevatoren	737, 840, 1052-1056, 1072-1074
ELSAESSER Nierenfistelzangen	876
EMMET Kornzangen	354
EMMET Wundhaken	436
Empyema Trokar	70
Endolaryngeale Mikrochirurgie	642-651
Endospekulas	896
ENGEL Gips sägen	1195
Enukleatoren	705
Epikardial Retraktoren	817
Episiotomie Scheren	101, 102, 152
Episiotomie TC Scheren	162
EPENDORF Uterus-Biopsiezangen	920, 922
ESMARCH Gipsmesser	1195
ESMARCH Verband- und Gips scheren	1190
EVES Tonsillenschnürer	623
EWALD Anatomische Pinzetten	198
EWALD Chirurgische Pinzetten	209
Exkavator	747
Explorations- & Koagulationshäkchen	834
Extensionsbügel	1154, 1155
<b>F</b>	
Face-lift Scheren	117
Face-lift SCT Scheren	190
Face-lift TC Scheren	175, 176
Fadenfänger	513, 627, 815, 822
Fadenführer	829
Fadengabeln	513, 827, 828
FAHLBUSCH Kürette	707
FAHLBUSCH Löffel	707
FAHLBUSCH Mikro-Schere	651
FANSLER Anuskope	862
FARABEUF Knochenhaltezeuge	1120
FARABEUF Raspatorien	1063
FARABEUF Wundhaken	417
FARABEUF-COLLIN Raspatorien	1063
FARABEUF-LAMBOTTE Knochenhaltezeuge	1120
FARRELL Watteträger	65
FARRIOR Ohrspekulas	720, 724
Fasspinzetten	204

DEUTSCH

FAULKNER Kieferhöhlenküretten	690	Fremdkörperhebel	731
FAURE Hysterektomieklappen	272	Fremdkörperinstrumente	731
FAURE Peritoneumklappen	278	Fremdkörperzangchen	731
FAURE Uterus-Biopsiezangen	916	Fremdkörperzangen	948
FAVALORO Gefäßscheren	134	FRENZEL Zungenspatel	600
FAVALORO Rippensperr	775	FRIEDMANN-JOLL Vulvaspreizer	896
FEHLAND Rektum-Anastomoseklappen	856	FRIEDMANN-MINI Hohlmeißelzangen	1127
FEILCHENFELD Splitterpinzetten	225	FRIEDMANN-VICKERS Hohlmeißelzangen	1127
FEIN Watteträger	633	FRITSCH Wundhaken	403
Feine chirurgische Scheren	123-130, 156-157	FRY Nasenzangen	990
Feine chirurgische SCT Scheren	190	FRYKHOLM Hohlmeißelzangen	1136
Feine chirurgische TC Scheren	177, 178	FUCHSIG Arterienklappen	247
FELDHEIM Kompressorium	1181	Führungsgabeln	747, 752
Fenestrierhaken	747	Führungshohlsonden	509-513
FERGUSSON Chirurgische Scheren	97	Führungsnadeln	66-68
FERGUSSON Darmklappen	853	FULLER Einführungszangchen für Teflonprothesen	742
FERGUSSON Gallensteinlöf	874	Furunkelmesser	735
FERGUSSON Knochenhaltezeuge	1119	<b>G</b>	
FERGUSSON Rektum-Anastomoseklappen	855	Galeahaken	545
FERGUSSON Saugrohre	78, 79	GALLAHER Nasenraspeln	1085
FERGUSSON-ACKLAND Mundsperr	603	Gallenblasenlöf	873
FERRIS-SMITH Chirurgische Pinzetten	215	Gallenblasentroker	71
FERRIS-SMITH Chirurgische TC Pinzetten	235	Gallenkanaldilatatore	872
FERRIS-SMITH-CUSHING Laminektomie-Zangen	979-983	Gallensteinlöf	873, 874
FERRIS-SMITH-CUSHING Laminektomie-Zangen, zerlegbar	981, 983	Gallensteinsonden	872, 873
FERRIS-SMITH-KERRISON Laminektomie-Stanzen	960-967, 978	Gallensteinzangen	877, 878
FICKLING Präparier- und Ligaturklappen	269	GARDNER Knochensplitterzangen	1141
FILIFORM Dilatationsbougies	949	GARRETT Gefäßdilatore	809
Finger-Goniometer	20	GAST Zungendrucker	615
Fingerringhaken	689	Gaummennadeln	626
Fingerringssägen	1011	Gaumensegelhalter	627
Fingerschutz	619	GAUSS Kopfschwartenzange	936
Finger-Wundspreizer	1183	Geburtslöf	936
FINOCHIETTO Nadelhalter	494	Geburtszangen	932-935
FINOCHIETTO Präparier- und Ligaturklappen	280	Gefäß Spülkanülen	73
FINOCHIETTO Rippensperr	771-773, 784, 785	Gefäß- und Tumorpinzetten	214, 216, 218
FINOCHIETTO TC Nadelhalter	527	Gefäßdilatore	808, 809, 827
FINSEN Wundspreizer, selbsthaltend	445	Gefäßdissektoren	814
FINSTERER Saugrohre	84	Gefäße	1212-1217
FISCHER Sehnenschäler	1153	Gefäßmesser	827, 838
FISCHER Tonsillennmesser	623	Gefäßscheren	115, 117, 131-137, 158
Fistelmesser	56	Gefäßspreizer	827
Fixationsklappen	946	GELFOAM Septumzange	701
Fixierpinzette	686	GELLHORN Uterus-Biopsiezangen	919
Flachmeißel	680-682, 751	GELPI Wundhaken	485
Flachmeißel	1025-1051	GELPI-LOKTITE Wundspreizer, selbsthaltend	456, 457
Flexibles Naso-Pharyngo-Laryngofiberskop	598	GELPI-SEILETZ Wundspreizer, selbsthaltend	457
FOERSTER Schwammzangen	359	GEMINI Präparier- und Ligaturklappen	265
FOERSTER-BALLENGER Schwammzangen	359	GERALD Anatomische Pinzetten	202
Foetal-Stethoskope	17	GERALD Anatomische TC Pinzetten	233
FOMON Fingerringhaken	689	GERALD Chirurgische Pinzetten	214
FOMON Nasenflügelhaken	688, 689	GERALD Chirurgische TC Pinzetten	235
FOMON Nasenplastikmesser	672	GERALD Ohr- und Nasenpinzetten	222
FOMON Nasenraspeln	1086, 1090	GERALD-BROWN Chirurgische Pinzetten	216
FOMON Nasenscheren	118, 119, 121	GERSTER Distraktionsklammer für Knochenhalteklappen	1126
FOMON Osteotome	683	GERZOG Hämmer	1017
FOMON SCT Nasenscheren	189	GERZOG-SEXTON Parazentesenadel	735
FOMON TC Tonsillenscheren	174	Gewebefasspinzetten	203, 204, 209, 217
FORD-DIXON Hämorrhoidal-Ligatore	868	Gewebekralle	830
FORMBY Zerumenlöf und Haken	730	GIERTZ-STILLE Rippscheren	767
FOSTER-GILLIES TC Nadelhalter	528	GIGLI Drahtssägen	1010
FOWLER Tonsillennmesser	57	GIGLI Handgriff für Drahtssägen	1010
FOX Lupusküretten	60	GILLIES Anatomische Pinzetten	199
FRAENKEL Broncho-Oesophagoskopiezangen	637	GILLIES Chirurgische Pinzetten	211
FRAENKEL Kehlkopfpolypenzangen	634, 635	GILLIES Chirurgische TC Pinzetten	234
FRANCKE Blutschnäpper	29	GILLIES Nadelhalter mit Schere	495
FRANZ Bauchdeckenhalter	474	GILLIES Osteotome	1026
FRASER-KELLY Arterienklappen	248	GILLIES TC Nadelhalter	528
FRAZIER Dura-Dissektoren	551	GILLIES Wundhaken	442
FRAZIER Durahaken	555	GILLIES-MINI TC Nadelhalter	528
FRAZIER Hirnventrikelpunktionskanüle	80	GILL-VERNET Wundhaken	438
FRAZIER Saugrohre	77	Gipsmesser	1195
FREEMAN-GORNEY Face-lift TC Scheren	176	Gipssägen	1195
FREEMAN-KAYE Face-lift TC Scheren	176	Gipsspreizer	1193, 1194
FREER Elevatorien	1054	GLASSMANN Atraumatische Pinzetten	218
FREER Flachmeißel	1025	GLOVER Atraumatische Gefäßklappen	303, 315, 316
FREER Hohlmeißel	1025	GLOVER Bulldogklappen	290, 296
FREER Mukosamesser	673	GLUCK Rippscheren	764
FREER Septumelevatorien	674, 675	GOLDMANN Nasenfraktur Elevatorien	698
FREER Wundhaken	443	GOLDMANN-FOX TC Zahnfleischscheren	177
FREER-GORNEY Saugellevator	674	GOLDMANN-FOX Zahnfleischscheren	125
FREER-JOSEPH Septumelevatorien	675	GOELET Wundhaken	418
FREER-YASARGIL Septumelevatorien	674	GOMEL Mikro-Schere	143



GOOD Tonsillenscheren	117	HARTMANN Arterienklemmen	250
GOOD-SCHWEKENDIECK Tonsillenscheren	117	HARTMANN Darmklemmen	846
GORNEY Face-lift TC Scheren	175	HARTMANN Hohlmeißelzangen	1129
GORNEY Präparierscheren	113	HARTMANN Nasenspekulas	661, 662
GORNEY-FREEMAN Face-lift TC Scheren	176	HARTMANN Nasenzangen	992
GOSSET Bauchdeckenhalter	469	HARTMANN Ohrhäkcken	731
GOSSET-BABY Bauchdeckenhalter	469	HARTMANN Ohrkatheter	716
GOURDET Uteruslöffel	924	HARTMANN Ohrpolypenzangen	732
GRAEFE Anatomische Skalpelle	51	HARTMANN Ohrspekulas	721-723
GRAEFE Feine chirurgische Scheren	129	HARTMANN Ohrzängchen	732, 733
GRAEFE Gewebefasspinzetten	209	HARTMANN Stimmgabeln	713-715
GRAEFE Hautfasspinzette	686	HARTMANN Tampon- und Polypenzangen	669, 670
GRAEFE Irispinzetten	197, 208	HARTMANN Watteträger	633
GRAEFE Wundhaken	429, 431	HARTMANN Zungendrucker	601
GRAHAM Durahaken	554	HARTMANN-HALLE Nasenspekulas	661
GRAVE Scheidenspekulas	883, 884, 886, 887	HARTMANN-HOFFMANN Ohrzängchen	733
GRAY Präparier- und Ligaturklemmen	280	HARTMANN-NOYES Ohrzängchen	733
GREEN-ARMYTAGE Uterusklemmzange	936	HARTMANN-WEINGAERTNER Ohrzängchen	733
GREGORY Atraumatische Gefäßklemmen	326	HARTMANN-WULLSTEIN Ohrzängchen	732
GREGORY Face-lift SCT Scheren	190	HARVEY Drahtscheren	148
GREGORY Face-lift TC Scheren	175	HARVEY-JACKSON Wundspreizer, selbsthaltend	463
GREGORY-SOFT Bulldogklemmen	297	HASLINGER Gaumensegelhalter	627
GREVEN Mikro-Drahtbiegezängchen	741	HASOBUCCHI Gabel	706
GREY-TURNER Arterienklemmen	256	HATFIELD Scharfe Löffel	1112, 1113
GRONINGEN Durahaken	554	Hautfasspinzette	686
GROSS Kornzangen	350, 351	Hauttrephine	60, 61
GROSS Ohrschlingen	730	HAYES Rektum-Anastomoseklemmen	857
GROSS-MAIER Kornzangen	349, 350	HEANEY Hysterektomieklappen	274
GRUBER Ohrspekulas	725	HEANEY Nadelhalter	492
GRUENWALD Nasenzangen	757	HEANEY TC Nadelhalter	526
GRUENWALD Zerstäuber	761	HEANEY-RAZAK Hysterektomieklappen	274
GRUENWALD-HENKE Nasenzangen	991	HEANLEY Hohlmeißelzangen	1127
GRUENWALD-JANSEN Ohr- und Nasenpinzetten	222	HEART-GATE Atrial Blatt Einführungszange	820
GUILLEN Saugelatorien	678	HEART-GATE Atrial Blätter	820
GUILFORD-WRIGHT Drahtscheren	148	HEART-GATE Atrial Blatthalter	820
GULEKE Hohlmeißelzangen	1131	HEART-GATE Atrial Haken	792, 793
GUNAR-HEY Schlauchklemmen	371	HEART-GATE Fadenfänger	822
GUSTELLA Osteotome	684	HEART-GATE Instrumente für minimalinvasive Chirurgie	818-823
GUTHRIE Wundhaken	432	HEART-GATE Kardioplegie-Kanüle	823
GUYON Dilatationsbougies	949	HEART-GATE Magnetstab	822
GUYON Katheterspanner	947	HEART-GATE Naht Lineal	823
GUYON Nierenstielklemmen	282-284	HEART-GATE Nerv- und Gefäßhaken	822
GWYNE-EVANS Tonsillendissektoren	623	HEART-GATE Rippensperrerr	791, 792
Gynäkologische Scheren	98-102	HEART-GATE Skalpelgriff	823
Gynäkologische TC Scheren	162	HEATH Hämmer	1015
<b>H</b>		HEATH Ligaturscheren	147
HABERER Bauch- und Darmspatel	421	HEGAR Nadelhalter	488
HACKSTOCK Drahtzangen	1161	HEGAR TC Nadelhalter	521
HAGLUND-STILLE Gipspreizer	1193	HEGAR Uterus-Dilatatoren	897, 898
HAIGHT Rippensperrerr	781	HEGAR-BAUMGARTNER Nadelhalter	490
HAJEK Hämmer	1013	HEGAR-BAUMGARTNER TC Nadelhalter	524
HAJEK Nasenzangen	991	HEGAR-VASCULAR TC Nadelhalter	532
HAJEK Saugrohre	87	HEGEMANN-DIETRICH Gefäßscheren	137, 158
HAJEK-CLAUS Laminektomie-Stanzen	958	HEGEMANN-DIETRICH SCT Gefäßscheren	191
HAJEK-KOFLER Laminektomie-Stanzen	959	HEGEMANN-DIETRICH TC Gefäßscheren	180
HAKANSSON Hohlmeißelzangen	1128	HEGENBARTH Wundklammerpinzetten	517
Häkchen	706, 708, 747, 748, 750, 752, 753, 831, 832, 841	HEIFETZ Hirnspatel	543
Hakenzangen	901-908	HEIMING Nierenfistelzangen	874
HALLE Duramesser	553	HEISS Arterienklemmen	244, 256
HALLE Scharfe Löffel	1098	HEISTER Mundsperrerr	603
HALLE Septumelevatorien	674	HELFERICH-BIER Amputations- und Resektionssägen	1009
HALSEY Nadelhalter	491	HEMINGWAY Scharfe Löffel	1093
HALSEY TC Nadelhalter	524	HENDERSON Wundspreizer, selbsthaltend	449
HALSTED-MOSQUITO Arterienklemmen	244, 250, 256, 258, 259	HENKE Tonsillendissektoren	622
Halterahmen für Mundsperrerr	617	HENLEY Atraumatische Gefäßklemmen	331
Hämmer	751, 1013-1020	HENLEY Wundspreizer, selbsthaltend	450, 451
Hammerkopfstanzen	742, 744	HENNIG Gipspreizer	1193
Hämorrhoidal-Ligatoren	866-868	Heparinnadeln	73
Handbohrapparate	1171-1173	HEPP-SCHIEDL Mikro-Scheren	143
Handgriff für Drahtsägen	1010	HERBERHOLD Zungendrucker	616
Handhalter	1182	HERMANN Flachmeißel	751
Handwaschbürsten	1227	HERMANN Hammer	751
HARDY Enukleatoren	705	HERMANN Hohlmeißel	751
HARDY Implantationsgabel	705	HERRICK Nierenstielklemmen	283
HARDY Kürette	707	HERTZLER Rippensperrerr	780
HARDY-FAHLBUSCH Dissektoren	703	HERZ Meniskus- und Knorpelfaßzangen	1145
HARGIS Unterkieferkörperhaken	1057	HERZ Sehnendurchziehungen	1150
HARGIS Vorderrandstripper	1057	HESS Bulldogklemmen	292
HARKEN Atraumatische Gefäßklemmen	334	HEY-GROVES Knochenhaltezeuge	1123
HARKEN Vena-Cava-Klemmen	348	HEYMANN Nasenscheren	120, 156
HARRINGTON Wundhaken	409, 485	HEYMANN SCT Nasenscheren	190
HARRINGTON-PEMBERTON Wundhaken	409	HEYMANN Septumzangen	696
HARTMANN (FRENCH) Stimmgabeln	713	HEYMANN-KNIGHT Tampon- und Polypenzangen	670

HEYWOOD-SMITH Polypen und Ovarienzangen	357	JAEGER Sehnendurchziehzangen	1151
HIBBS Flachmeißel	1038	JAMESON Messzirkel	22
HIBBS Hohlmeißel	1039	JAMESON Nadelhalter	492
HIBBS Osteotome	1038	JAMESON Präparierscheren	114, 155
Hirnmesser	55	JAMESON SCT Präparierscheren	189
Hirnspatel	543, 544	JAMESON TC Präparierscheren	172
Hirnventrikelpunktionskanülen	80	JANET Spritzen	75, 76
HIRSCHMANN Anuskope	863	JANSEN Hohlmeißelzangen	1129, 1130
HOEN Dura-Dissektoren	551	JANSEN Ohr- und Nasenpinzetten	222
HOEN Laminektomie-Zangen	1007	JANSEN Ohrküretten	730
HOEN Raspatorien	1068	JANSEN Raspatorien	1060, 1064
HOEN V. EICKEN Fadenfänger	627	JANSEN Scharfe Löffel	1091, 1092
HOESEL TC Nadelhalter	530	JANSEN Stirnlampen	27
HOESEL Wundhaken	408	JANSEN Wundspreizer, selbsthaltend	446
HOFF Tuchklemmen	369	JATHO Nasenrachenzangen	631
Hohlmeißel	751, 1025-1051	JAVID Atraumatische Gefäßklemmen	326, 327
Hohlmeißelzangen	1126-1140	JENNINGS Mundsperrer	605
Hohlsonden	63	JIKEI Nasenzangen	759, 760
HOHMANN Knochenhebel	1077-1079	JOBSON-HORNE Watteträger	65
HOKE Osteotome	1037	JOHN-HOPKINS Anlegezange für Bulldogklemmen	293
HOLINGER Operationslaryngoskope	641	JOHN-HOPKINS Bulldogklemmen	292, 293
HOLSHER Nervwurzelhaken	553	JOHNS-HOPKINS Präparier- und Ligaturklemmen	281
HOLZBACH Arterienklemmen	258	JONES Tuchklemmen	369
HOLZBACH Bauchdeckenhalter	475	JORGENSON Gefäßscheren	132
HOLZHEIMER Wundspreizer, selbsthaltend	445	JOSEPH Feine chirurgische Scheren	123
HOPKINS Gipsmesser	1195	JOSEPH Feine chirurgische SCT Scheren	190
Hornhauthobel	1207	JOSEPH Feine chirurgische TC Scheren	177
HORSLEY Nervwurzelhaken	552	JOSEPH Nasenplastikmesser	672, 673
HOUSE Mikro-Nadel	748	JOSEPH Nasenraspeln	1084
HOUSE Raspatorium	747	JOSEPH Nasensägen	685
HOUSE Saugrohre	86	JOSEPH Raspatorien	1053
HOUSE Scharfe Löffel	751	JOSEPH Septumelevatoren	677
HOUSE Trachealhäkchen	656	JOSEPH Septummesser	673
HOUSE-DIETER Hammerkopfstangen	742	JOSEPH TC Präparierscheren	172
HOWARTH Septumelevatoren	678	JOSEPH Wundhaken	443
HUBER Universalgriff	636, 923	JOSEPH-MASING Septumelevatoren	677
HUDSON Handbohrapparate	1172	JUDD-ALLIS Darm- und Gewebefäßzangen	365
HUGHES Steigbügelhäkchen	747	JUDD-MASSON Blasenwundspreizer	952
HUMBY Dermatom	59	JUERS Mikro-Drahtbiegezängchen	742
HUNTER Splitterpinzetten	225	JURASZ Kehlkopfpolypenzangen	634
HURD Gaumennadeln	626	JURASZ Nasenrachenzangen	631
HURD Tonsillendissektoren	622	<b>K</b>	
HUSFELDT Atraumatische Gefäßklemmen	327	KABIERSKE Pulverbläser	718
Hysterektomieklappen	271-276, 286	KADER Wundhaken	425
<b>I</b>		KAHN Face-lift Scheren	117
I.M.A. Mammaria Sperrer	794-797	KALLMORGEN Scheidenspekulas	891
Implantationsgabel	705	KALT Nadelhalter	497
INGE Wirbelkörperspreizer	592	KANE Nabelschnurklemmen	937
Injektionskanüle	72	KANTROWITZ Präparier- und Ligaturklemmen	266
Instrument für die Entfernung von Spiralen	911	Kapsel-fäßzangen	955
Instrumente für minimalinvasive Chirurgie	818-823	Kapselscheren	105
Instrumente für schlagende Herzchirurgie	824	Kardioplegie-Kanülen	823
Instrumenten Pflegemittel	1227	KARLIN-CRANK Laminektomie-Spreizer	588
Instrumentenkästen	1216, 1217	Katheter-Einführungsinstrument	947
Instrumentenschalen	1215, 1216	Katheter-Einführungszangen	944
Insufflationskanülen	73	Katheterspanner	947
Interdentale Osteotome	1036	KATSCH Komedoneninstrument	61
Intimaspatel	813, 814	KATZIN Mikro-Scheren	142
Intubationsrohre	653	KATZIN-BARRAQUER Mikro-Scheren	142
IOWA Hakenzangen	905	KAYE Face-lift Scheren	118
IOWA Injektionskanülen	72	KAYE Face-lift TC Scheren	175
IRIS Feine chirurgische Scheren	127-129, 157	KAYE-MILLARD Wundhaken	444
IRIS Feine chirurgische SCT Scheren	191	Kehlkopfdeckelhalter	633
IRIS Feine chirurgische TC Scheren	178	Kehlkopfpolypenzangen	634, 635
Irispinzetten	197, 208	Kehlkopfspiegel	632
Irrigatoren	1215	Kehlkopf-Spritze	76
IRWIN Wundspreizer, selbsthaltend	456	Keilosteotome	1035
ISRAEL Wundhaken	380	KELLY Arterienklemmen	249
ITERSON Trachealhäkchen	655	KELLY Feine chirurgische Scheren	123, 156
IVES-FANSLER Anuskope	863	KELLY Feine chirurgische SCT Scheren	190
<b>J</b>		KELLY Feine chirurgische TC Scheren	177
JABALEY Feine chirurgische Scheren	130, 157	KELLY Polypen und Ovarienzangen	356
JACKSON Scheidenspekulas	893	KELLY Präparier- und Ligaturklemmen	270
JACKSON Sehnendurchzieh-zangen	1150	KELLY Sphinkteroskope	863
JACKSON Trachealhäkchen	656	KELLY Wundhaken	406, 412, 413, 485
JACKSON-BURROWS Wundspreizer, selbsthaltend	457	KELLY-RANKIN Arterienklemmen	247
JACOBS Hakenzangen	906	KELMAN-MC PHERSON Mikropinzetten	227
JACOBSON Doppelsonde	827	Kephalotomieschere	100
JACOBSON Fadengabel	827, 828	KERN-LANE Knochenhalte-zange	1119, 1121
JACOBSON Gefäßmesser	827, 838	KERPEL Scharfe Löffel	1114
JACOBSON Knopfsonde	827, 828	KERRISON Laminektomie-Stanzen	958, 976, 977
JACOBSON Scharfe Löffel	1091	KERSTING Rektum-Anastomoseklemmen	858
JAEGER Meniskus- und Knorpelfäßzangen	1145	KEVORKIAN Biopsieküretten	912





KEVORKIAN Uterus-Biopsiezangen	920, 922	Komedoneninstrument	61
KEVORKIAN-PACIFIC Uterus-Biopsiezangen	921	Kompressorium	1181
KEY Raspatorien	1068	Komprimeter	29
KEYES Hauttrephine	60	Konisationsmesser	56
Kieferhöhlenküretten	690-692	KONRICH Verbandstofftrommeln	1224
Kieferhöhlenlöffel	691, 692	KOOS Gefäßmesser	838
Kieferhöhlenpunktionskanüle	87	Kopfschwartzange	936
Kieferhöhlenraspeln	693	Kornzangen	349-352, 354, 355
Kieferhöhlenspülkanülen	88	KRAEMER Raspatorien	1063
Kieferhöhlentrokar	69, 70, 87	KRAEMER Wundhaken	388
KIELLAND Geburtszangen	933	Krampfaderbesteck	806, 807
KILLIAN Elevatorien	1055	Krampfaderinstrumente	815
KILLIAN Nasenspekulas	663-666	Kranioklast	938
KILLIAN Raspatorien	1055	KRAUS Gefäßmesser	838
KILLIAN Septumlevatorien	678	KRAUSE Broncho-Oesophagoskopiezangen	637
KILLIAN Septum-Hohlmeißel	679	KRAUSE Kieferhöhlentrokar	71
KILLIAN Septumscheren	700	KRAUSE Ohrpolypenschnürer	738
KILLIAN Tampon- und Polypenzangen	670	KRAUSE Polypenschnürer	671
KILLIAN Watteträger	633	KRAUSE-VOSS Ohrpolypenschnürer	738
KILLIAN-CLAUS Septum-Hohlmeißel	679	KRAUSE-VOSS Polypenschnürer	671
KILLIAN-RUDERT Nasenspekulas	665	KRAYENBUEHL Nerv- und Gefäßhaken	829
KILNER (RAGNELL) Präparierscheren	113, 155	KRESSNER Septumzangen	699
KILNER Feine chirurgische Scheren	126	KRISTELLER Scheidenspekulas	889-890
KILNER Nadelhalter	491	KRISTELLER WIENER Scheidenspekulas	891
KILNER Nasenflügelhäkchen	688	KROENLEIN Arterienklemmen	251
KILNER TC Nadelhalter	525	KRONECKER Unterbindungsnadeln	502
KILNER TC Präparierscheren	172	Kropffasszange	657
KILNER Wundhaken	419, 439, 442	Kropfsonden	657
KILNER-DOUGHTY Mundsperrer	613	KUEHNE Deckglaspinzetten	226
Kinnhalter	383, 1057	KUEMMEL Wundhaken	401, 424
KIRK Hämmer	1017	KUESTNER Hakenzangen	904
KIRKLIN Wundhaken	438	Kugeldissektoren	840
KIRSCH Wundhaken	388	Küretten	703, 704, 706-708, 1110-1112
KIRSCHNER Bauchdeckenhalter	472, 473	<b>L</b>	
KIRSCHNER Extensionsbügel	1154, 1155	LA FORCE Tonsillotome	630
KIRSCHNER Führungshohlsonden	510, 511	LA GRANGE Zahnfleischschere	124
Klammeranlagezangen ETHICON	518	LABORDE Trachealdilatator	654
Klammerinstrumentarium	546, 547	LACK Zungendrücker	601
KLAPP Wundhaken	433	LAHEY Hakenzangen	908
KLEINERT-KUTZ Hohlmeißelzangen	1127, 1132	LAHEY Kropffasszange	657
KLEINERT-KUTZ Sehnendurchziehungen	1152	LAHEY Präparier- und Ligaturklemmen	280, 281
KLEINERT-KUTZ Wundhaken	444	LAHEY Wundhaken	438
KLEINSCHMIDT Darmklemmen	852	LAMBERT-KAY Atraumatische Gefäßklemmen	330
Klemmenhalter	845	LAMBOTTE Knochenhaltezeuge	1124, 1125
Klemmschließzange	845	LAMBOTTE Osteotome	1034
KLIMA-ROSEGGER Sternalpunktionkanüle	73	LAMBOTTE Raspatorien	1065
Klingenbrecher	47	LAMBOTTE Wundhaken	378
Klingenhalter	47	Laminektomie-Spreizer	564-567, 586-591
KLINKENBERGH-LOTH Gefäßscheren	131	Laminektomie-Stanzen	958-978, 984, 985
KNAPP Wundhaken	432	Laminektomie-Stanzen, zerlegbar	962, 966
KNIGHT Nasenscheren	121	Laminektomie-Wundsperrer	556-559
KNIGHT Septumzangen	696	Laminektomie-Zangen	979-983, 985-987, 994-1007
KNIGHTON Wirbelkörperspreizer	593	LANDAU Scheidenspekulas	893
Knöchelfasszangen	1117	LANDAU Trokare	71
Knochen- und Gelenkspreizer	1184	LANDOLT Eukleatoren	706
Knochenformzange	1118	LANDOLT Häkchen	706
Knochenhalteklammern	1126	LANDOLT Kürette	706
Knochenhaltezeuge	1117-1125	LANDOLT Laminektomie-Zangen	1005
Knochenhebel	1075-1083	LANDOLT Löffel	706
Knochensplitterzangen	1141-1144	LANDOLT Nasenscheren	121
Knopfsonden	62, 827, 828	LANDOLT Raspatorien	562
Knorpelmesser	53, 54	LANDOLT Skalpellgriffe	826
Knorpelquetsche	686	LANDOLT Spreizzange für Spekulas	702
Knorpelritzmesser	672	LANDOLT-REULEN Dissektoren	708
Knorpelscheren	115, 116	LANDOLT-REULEN Kürette	708
KNOWLES Verbandsscheren	1186	LANDOLT-REULEN Raspatorium	708
Koagulations Saugrohre	87	LANDON Scheidenspekulas	892
KOCHER Arterienklemmen	254, 255	LANE Chirurgische Pinzetten	215
KOCHER Blasenspatel	953	LANE Darmklemmen	853
KOCHER Darmklemmen	846, 848	LANE Knochenhebel	1076
KOCHER Kropfsonden	657	LANE Tuchklemmen	368
KOCHER Unterbindungsnadeln	502	LANE-TRETHOWAN Knochenhebel	1076
KOCHER Wundhaken	376, 392, 399, 404	LANGE Broncho-Oesophagoskopiezangen	637
KOCHER-LANGENBECK Wundhaken	389, 390	LANGE Verbandsscheren	1186
KOCHER-WAGNER Wundhaken	405	LANGE Wundhaken	436
KOELNER Kopfhautklammern	546	LANGE-HOHMANN Knochenhebel	1079, 1080
KOENIG Elevatorien	1052	LANGENBECK Amputations- und Resektionssägen	1010
KOENIG Führungshohlsonden	512	LANGENBECK Amputationsmesser	52
KOENIG Raspatorien	1053	LANGENBECK Elevatorien	1074
KOENIG Stimmgabeln	714	LANGENBECK Fingerschutz	619
KOENIG Wundhaken	437	LANGENBECK Knochenhaltezeuge	1118
KOERTE Wundhaken	379, 424	LANGENBECK Ohrschlingen	728
KOGAN Endospekulas	896	LANGENBECK Raspatorien	1064

LANGENBECK Resektionsmesser	53	LOVE Gaumensegelhalter	627
LANGENBECK TC Nadelhalter	531	LOVE Nervwurzelhaken	551, 552, 553
LANGENBECK Wundhaken	381-383	LOVE-GRUENWALD Laminektomie-Zangen	996
LANGENBECK-RYDER TC Nadelhalter	534	LOVELACE Lungenfaßzangen	801
LANGE-WILDE Ohrpolypenschnürer	738	LOWER Präparier- und Ligaturklemmen	281
LANGE-WILDE Polypenschnürer	671	LOWMAN Knochenhalteklammern	1126
LANG-STEVENSON Darmklemmen	852	LOWMAN-HOGLUND Knochenhalteklammern	1126
Lanzettenmesser	747, 752, 837	LUBET-BARBON Tampon- und Polypenzangen	669
Lappenmesser	745	LUC Septumzangen	697
Lärmtrommeln	716	LUCAE Hämmer	1016
Laryngealschnürer	652	LUCAE Ohr- und Nasenpinzetten	221, 222
Laryngologie	652, 653	LUCAE Parazentesenadeln	737
Laryngoskope Batteriegriffe	42-43	LUCAE Stimmgabeln	713, 714
Laryngoskope mit Kaltlicht und Zubehör	40-41, 43	LUCAE Wundhaken	429
Laryngoskope und Zubehör	36-43	LUCAS Scharfe Löffel	1091
LAWRENCE Präparier- und Ligaturklemmen	264	LUER Darm- und Gewebefaßzangen	366
Leberblindpunktionskanülen	74	LUER Hohlmeißelzangen	1128, 1130
LEBSCHKE Einführungsinstrumente	549	LUER Spritzen	74
LEBSCHKE Sternummeißel	764	LUER Tracheal-Kanülen	654
LEES Atraumatische Gefäßklemmen	314, 323	LUER Wundhaken	419
LEGUEU Blasenpatel	953	LUER-FRIEDMANN Hohlmeißelzangen	1127
LEGUEU Blasenwundspreizer	952	LUER-KOERTE Gallensteinlöffel	873
LEKSELL Hohlmeißelzangen	1137	LUER-LOCK Spritzen	74, 76
LEKSELL-STILLE Hohlmeißelzangen	1137	LUER-STILLE Hohlmeißelzangen	1138, 1139
LELAND-JONES Atraumatische Gefäßklemmen	317-319	Luftbläser	75
LEMPERT Elevatoren	737	Luftduschen	716, 717
LEMPERT Raspatorien	1054	LUIKART-BILL Zangenschloß	936
LEMPERT Saugrohre	80	LUKENS Trachealhäkchen	656
LEMPERT Scharfe Löffel	1098	Lumbales Mikrodiskektomie Retraktor Set	583
LERCHE Chirurgische Pinzetten	218	Lungenfasspinzetten	216
LERICHE Arterienklemmen	247, 257	Lungenfaßzangen	801
LERICHE Wundhaken	423	Lungenspatel	800, 801
LEWIN Repositionszangen	1116	LUNIATSCHEK Tamponstopfer	626
LEWIS Nasenraspeln	1084	Lupusküretten	60
LEWKOWITZ Steinzangen	945	Lupusschaber	60
LEXER Flachmeißel	1042	LURZ Gallensteinzangen	877
LEXER Hohlmeißel	1043, 1044, 1048	Luxationshebel	1083
LEXER Osteotome	1043, 1047	<b>M</b>	
LEXER Präparierscheren	112, 155	M.G. HOSPITAL Nadelhalter	489
LEXER SCT Präparierscheren	188	Magenklemmen	851
LEXER Spongiosa Hohlmeißel	1045, 1048	MAGILL Katheter-Einführungszangen	944
LEXER TC Präparierscheren	171	MAGILL Saugrohre	79
LEXER-BABY Präparierscheren	112	Magnetstab	822
LEXER-MINI Hohlmeißel	1041	MAINGOTT Hysterektomieklammern	275
LEXER-MINI Osteotome	1041	MALTZ Nasenraspeln	1085, 1087
LEYLA Retraktoren zur Fixation am Schädel	540-542	Mamillenringe	21
LICHTENBERG Nadelhalter	497	Mammoplastik Wundhaken	422
LICHTENBERG TC Nadelhalter	530	Mammaria Sperrer	794-797
LICHTWITZ Kieferhöhlenpunktionskanüle	87	MANNERFELT Hohlmeißel	1181
LICHTWITZ Kieferhöhlenretrokarie	70, 87	MANNERFELT Osteotome	1181
Ligatur-Gummiringe	866	MANNERFELT Raspatorien	1180, 1181
Ligaturinstrumente	627	MANNERFELT Wundhaken	1178-1180
Ligaturscheren	146, 147	MARKWALDER Hohlmeißelzangen	1139
Lippen- und Wangenhalter	618	MARQUARDT Hohlmeißelzangen	1133
LISTER Dilatationsbougies	950	MARSCHIK Tonsillenfasszangen	620
LISTER Sinusklemmen	352	MARSCHIK-KRONE Tonsillenfasszangen	621
LISTER Verband- und Gipscheren	1190	MARTIN Abfallzangen	1218
LISTER Verbandscheren	1187	MARTIN Beckenzirkel	931
LISTON Amputationsmesser	52	MARTIN Fingerringssägen	1011
LISTON Knochensplitterzangen	1141-1143	MARTIN Gipsmesser	1195
LISTON-KEY Knochensplitterzangen	1144	MARTIN Knorpelscheren	116
LISTON-STILLE Knochensplitterzangen	1143	MARTIN Kornzangen	351
LITTAUER Cilienpinzetten	223	MARTIN Meniskus- und Knorpelfaßzangen	1146
LITTAUER Ligaturscheren	147	MARTIN Uterussonden	899
LITTAUER Ohrpolypenzangen	732	MARTIN Watteträger	65
LITTAUER Tampon- und Polypenzangen	670	MARTIN Wundhaken	375, 377, 414
LITTLE Wundhaken	438	MARTIN-CUSHING Raspatorien	1071
LITTLER Feine chirurgische Scheren	126	MARTINI Scharfe Löffel	1091
LITTLER Ligaturscheren	147	MARTIN-LANGENBECK Raspatorien	1071
LITTLEWOOD Darm- und Gewebefaßzangen	365	MASING Knorpelritzmesser	672
LLOYD-DAVIES Rektumscheren	106	MASING Nasenhaken	690
LLOYD-DAVIES Rektum-Anastomoseklammern	856	MASING Ohrzängchen	734
LOCKHART-MUMMERY Sonden	64	MASING Septumlevatorien	677
LOCKLIN Gefäßscheren	133	Maßbänder	21
LOCKLIN TC Zahnfleischscheren	178	MASSON Nadelhalter	493
LOCKWOOD Darm- und Gewebefaßzangen	362	MASSON TC Nadelhalter	527
LOCKWOOD-ALLIS Darm- und Gewebefaßzangen	365	MASSON-LUETHY Nadelhalter	494
Löffel	706, 707, 831, 832, 840, 841	Mastdarmspekulas	861, 862
LOPEZ-REINKE Tonsillendissektoren	622	MASTIN Muskelklemme	657
LORENZ Verband- und Gipscheren	1190	MATHIEU Analspreizer	861
LORNA (EDNA) Tuchklemmen	369	MATHIEU Fremdkörperzangen	948
Lösungsschalen	1212	MATHIEU Nadelhalter	496
LOUTE Cerclage-Instrumente	1158	MATHIEU Scheidenspekulas	892



MATHIEU TC Nadelhalter	528, 529	MICK Verband- und Gipsscheren	1188, 1189
MATHIEU Wundhaken	418	MICRO-ADSON Arterienklemmen	245
MATHIEU-RYDER TC Nadelhalter	534	MICRO-MOSQUITO Arterienklemmen	250, 259
MATZENAUER Scheidenspekulas	892	MICRO-RYDER TC Nadelhalter	532
MAUNDER Mundkeile	619	MICRO-VASCULAR TC Nadelhalter	532
MAXIMUS Blutdruckmessgeräte	24	MIDDELDORPF Wundhaken	400
MAYFIELD Hohlmeißelzangen	1132	MIDDLETON-JANSEN Septumzangen	699
MAYO Chirurgische Scheren	103, 152	Mikro Dissektoren	814
MAYO Chirurgische SCT Scheren	186	Mikro-Drahtbiegezügeln	741, 742, 744
MAYO Chirurgische TC Scheren	165	Mikro-Faßzangen	642-643, 646, 649-651
MAYO Gallensteinlöffel	874	Mikro-Häkchen	749
MAYO Sterilisierklammern	372	Mikro-Instrumente	745-753, 827-841
MAYO TC Ligaturscheren	181	Mikro-Löffelzängchen	739, 743
MAYO Zungenspatel	600	Mikro-Löffelzangen	642, 647-651
MAYO-ADAMS Wundspreizer, selbsthaltend	449	Mikro-Messer	745
MAYO-BLAKE Gallensteinzangen	877	Mikro-Nadelhalter	643, 644
MAYO-GUYON Nierenstielklemmen	285	Mikro-Nadeln	748, 749, 752, 753
MAYO-HARRINGTON Chirurgische Scheren	105, 153	Mikro-Ohrscherchen	740, 744
MAYO-HARRINGTON Chirurgische SCT Scheren	186	Mikro-Ohrzängchen	739, 743
MAYO-HARRINGTON Chirurgische TC Scheren	165	Mikro-Pinzetten	226-228
MAYO-HEGAR Nadelhalter	488, 489	Mikro-Scheren	138-143, 644, 646, 651
MAYO-HEGAR TC Nadelhalter	521	MIKULICZ Peritoneumklemmen	277-279
MAYO-LEXER TC Präparierscheren	171	MIKULICZ Wundhaken	392, 393
MAYO-NOBLE Chirurgische Scheren	105	MILAN Biopsieküretten	914
MAYO-ROBSON Darmklemmen	850	MILIGAN Wundspreizer, selbsthaltend	449
MAYO-RUSSIAN Gewebefasspinzetten	203	MILLARD (COTTLE) Fingerringhäkchen	689
MAYO-STILLE Chirurgische Scheren	104, 153	MILLER Laryngoskope	37
MAYO-STILLE Chirurgische SCT Scheren	187	MILLER Laryngoskope mit Kaltlicht	41
MAYO-STILLE Chirurgische TC Scheren	167	MILLER Nasenraspeln	1087
MC CLINTOCK Plazenta- und Abortuszangen	940	MILLER Scharfe Löffel	1092
MC CLURE Mikro-Scheren	138	MILLER-COLBURN Nasenraspeln	1088
MC CULLOCH Laminektomie-Spreizer	586, 587	MILLER-COLBURN Scharfe Löffel	1094
MC DONALD Raspatorien	1055	MILLIGAN Dura-Dissektoren	550
MC GEE Häkchen	750	MILLIN Blasenhalsspreizer	953
MC GEE Mikro-Drahtbiegezügeln	741, 744	MILLIN Blasenwundspreizer	952
MC GIVNEY Hämorrhoidal-Ligatoren	868	MILLIN Kapsel-faßzangen	955
MC GLAMRY Raspatorien	1068	MILLS Gefäßscheren	137
MC INDOE Anatomische Pinzetten	199	MINI-HOHMANN Knochenhebel	1075
MC INDOE Anatomische TC Pinzetten	232	MINI-LAMBOTTE Osteotome	1030, 1031
MC INDOE Chirurgische Pinzetten	211	MINI-LANGENBECK Wundhaken	439
MC INDOE Knorpelscheren	115	MINIMUS Blutdruckmessgeräte	24
MC INDOE Osteotome	684	MINI-OLSEN Nadelhalter mit Schere	495
MC INDOE Wundhaken	443	MINI-ROUX Wundhaken	417
MC INTOSH Laryngoskope	38	MINI-TOWNSEND Uterus-Biopsiezangen	922
MC INTOSH Laryngoskope mit Kaltlicht	40	Mini-Transformator	27
MC IVOR Mundsperrerr	614	MINI-VANNAS Mikro-Scheren	138
MC IVOR Zungendrucker	616	MISKIOM Wundspreizer, selbsthaltend	454
MC KENTY Septumelevatorien	676, 677	MIXTER Chirurgische Scheren	97
MC KENZIE Klammerzangen	547	MIXTER Gallensteinzangen	878
MC KENZIE Silberklammern	546	MIXTER Präparier- und Ligaturklemmen	268, 280
MC KENZIE Silberklammernblock	546	MIXTER-O'SHAUGNESSY Präparier- und Ligaturklemmen	281
MC KESSON Mundkeile	619	MKG Wundhaken	1057
MC QUIGG-MIXTER Atraumatische Gefäßklemmen	300	MOCK Heparinnadeln	73
MEAD Hämmer	1013	MOELTGEN Winkelmesser	20
MEAD Hohlmeißelzangen	1130	MOLDENHAUER Ohrhebel	730
Meatotom	948	MOLDESTAD Wundhaken	433
Medizinbecher	1213, 1214	MOLLISON Wundspreizer, selbsthaltend	447
Medizinlöffel	1213	MOLT Mundsperrerr	603
MEEKER Präparier- und Ligaturklemmen	266	MOLT Raspatorien	1054
MEMORY Hirnspatel	544	MOORE Gallenblasenlöffel	873
MENGHINI Leberblindpunktionskanülen	74	MOORE Handbohrapparate	1171
Meniskus- und Knorpelfaßzangen	1145, 1146	MOORFIELD Nahtpinzetten	198
Meniskusmesser	1146, 1147	MORGAN Proktoskope	864
MERCEDES Rippensperrerr	790	MORITZ-SCHMIDT Zungendrucker	601
Messbecher	1213	MORRIS Wundhaken	401
Messschieber	559	MORRIS-DE BAKEY Atraumatische Gefäßklemmen	324
Messstäbe	22	MORSE Rippensperrerr	775, 778, 779
Messzirkel	20, 22	MORSE-FAVALORO Rippensperrerr	778
Metallkatheter	951	MOSHER-BRUENINGS Intubationsrohr	653
METZENBAUM Nadelhalter	489	MOSQUITO-DANDY Arterienklemmen	248
METZENBAUM Präparierscheren	108-111, 154	MOYNIHAN Gallensteinsonden	872
METZENBAUM SCT Präparierscheren	187, 188	MOYNIHAN Hysterektomieklammern	273
METZENBAUM TC Ligaturscheren	181	MUCK Periotom	735
METZENBAUM TC Präparierscheren	167-170	MUEHLING Raspatorien	562
METZENBAUM-BABY Präparierscheren	111, 155	MUELLER Rektum-Anastomoseklammern	858
METZENBAUM-LAHEY TC Präparierscheren	173	MUELLER Wundspreizer, selbsthaltend	445
MEYER Repositionszangen	1116	MUENCHEN Biopsieküretten	913
MEYERDING Wundhaken	407, 441, 489	Mukosamesser	673
MEYERDING Wundspreizer, selbsthaltend	452	Mundkeile	619
MICHEL Rhinoskopiepiegel	632	Mundsperrerr	603-614
MICHEL Wundklammern	516	MURPHY Stirnband	35
MICHEL Wundklammerpinzetten	517	MURPHY-LANE Luxationshebel	1083
MICHEL Wundklammerzangen	517	MUSEUX Hakenzangen	905, 906, 908

<b>MUSGROVE</b> Zerumnadel und Watteträger	730	<b>OBWEGESER</b> Unterbindungsadeln	501
Muskelklemmen	657	<b>OBWEGESER</b> Weichteilhaken	384, 385
<b>MYLES</b> Nasenzangen	990	<b>OBWEGESER</b> Weisheitszahnhaken	387
Myomheber	908	<b>OCHSNER</b> Anatomische Pinzetten	203
Myommesser	56	<b>OCHSNER</b> Atraumatische Gefäßklemmen	331
Myringotom	735	<b>OCHSNER</b> Gallenblasentroker	71
Myrtenblattsonden	62	<b>OCHSNER</b> Gallensteinsonden	873
<b>N</b>		<b>OCHSNER-KOCHER</b> Arterienklemmen	252, 253
<b>NABATOFF</b> Krampfaderbesteck	806	<b>O'CONNOR</b> Wundhaken	431
Nabelschnurklemmen	937	Ohr- und Nasenpinzetten	221, 222
Nabelschnurscheren	102	Ohrhäkcken	730, 731
Nadeln	841	Ohrhebel	730
Nadeldosen	1222, 1223	Ohrkatheter	716
Nadelhalter	488-499	Ohrküretten	728-730
Nadelhalter mit Hartmetalleinlagen	520-535	Ohr lupen	726, 727
Nadelhalter mit Schere	495	Ohrpolypenschnürer	738
Nadel-Sterilisationsgestelle	1223	Ohrpolypenzangen	732
<b>NAEGELE</b> Geburtszangen	932	Ohrsclingen	728-730
Nagelbohrer	1207	Ohrspekulas	720-726
Nagelfeilen	1206	Ohrspritzen	719
Nagelscheren	1204	Ohrzängchen	732-734
Nagelzangen	1205, 1206	<b>OKONEK-YASARGIL</b> Tumorgabeln	828
<b>NAGER</b> Gaumensegelhalter	627	<b>OLDBERG</b> Laminektomie-Zangen	1005
Naht Lineale	823	<b>OLIVECRONA</b> Drahtsägen	1010
Nahtpinzetten	198	<b>OLIVECRONA</b> Dura-Dissektoren	550
Nasenflügelhäkchen	688, 689	<b>OLIVECRONA</b> Hirnspatel	544
Nasenfraktur Elevatorien	698	<b>OLIVECRONA</b> Hohlmeißelzangen	1131
Nasenhaken	687-690	<b>OLIVECRONA</b> Nasenscheren	120
Nasenplastikmesser	672	<b>OLIVECRONA</b> Trigeminiussmesser	57
Nasenrachenzangen	631	<b>OLIVECRONA-TOENNIS</b> Klammerzangen	547
Nasenraspeln	1084-1090	<b>OLLIER</b> Wundhaken	380
Nasensägen	685	<b>OLSEN-HEGAR</b> Nadelhalter mit Schere	495
Nasenscheren	118-122, 156, 754	<b>OLSEN-HEGAR</b> TC Nadelhalter	527
Nasenspekulas	660-668	<b>OMBREDANNE</b> Hämmer	1015
Nasenzangen	756-760, 988-994	Operationslaryngoskope	638-641
<b>NEFF</b> Meniskusmesser	1146	Organfasszangen	358
<b>NEGUS (GUEDEL)</b> Laryngoskope	36	Organmesser	55
<b>NEGUS</b> Bruststütze für alle Mundsperrler	617	<b>O'SHAUGNESSY</b> Präparier- und Ligaturklemmen	281
<b>NEGUS</b> Nierenstielklemmen	282	Osteotome	680-684, 1021, 1026-1051
<b>NEGUS</b> Ringmesser	629	<b>O'SULLIVAN-O'CONNOR</b> Scheidenspekulas	895
<b>NEIVERT</b> Nadelhalter	491	<b>O'SULLIVAN-O'CONNOR</b> Bauchdeckenhalter	476
<b>NEIVERT</b> Nasenflügelhäkchen	690	Oszillierende elektrische Autopsiesägen	1022, 1023
<b>NEIVERT-ANDERSON</b> Osteotome	683	Oszillierende elektrische Gips sägen	1196-1199
<b>NEIVERT-MASING</b> TC Nadelhalter	524	<b>OTIS</b> Urethrotom	954
<b>NÉLATON</b> Hohlsonden	63	Otoskope	599, 712
<b>NELSON</b> Lungenfasspinzetten	216	<b>OVERHOLT</b> Präparier- und Ligaturklemmen	261, 262
<b>NELSON</b> Trokare	69	<b>OVERHOLT-GEISSENDOERFER</b> Präparier- und Ligaturklemmen	260
Neonatal-Gefäßklemmen	298-299	<b>OVERHOLT-MIXTER</b> Präparier- und Ligaturklemmen	268
Nerv- und Gefäßhaken	822, 829	<b>P</b>	
Nervwurzelhaken	551-553	<b>PACHON</b> Blutdruckmessgeräte	24
<b>NEW ORLEANS</b> TC Nadelhalter	526	<b>PAPAVERO-CASPAR</b> Spekulas für Hypophysektomie	702
<b>NEWS</b> Trachealhäkchen	656	Parazentesenadeln	735-737
<b>NICOLA</b> Kürette	704	<b>PARKER</b> Wundhaken	417
<b>NICOLA</b> Mikro-Löffelzange	651	<b>PARKER-BABY</b> Wundhaken	417
<b>NICOLA</b> Mikro-Schere	651	<b>PARKER-KERR</b> Rektum-Anastomoseklemmen	855
<b>NICOLA</b> Raspatorium	704	<b>PARKER-LANGENBECK</b> Wundhaken	418
<b>NIEDERDELLMANN</b> Osteotome	1038	<b>PARKER-MOTT</b> Wundhaken	418
Nierenfistelzangen	874, 876	<b>PARKS</b> Nasenraspeln	1087
Nierenschalen	1212	<b>PARTSCH</b> Flachmeißel	1027
Nierensteinzangen	875	<b>PARTSCH</b> Hämmer	1017
Nierenstielklemmen	282-284	<b>PARTSCH</b> Hohlmeißel	1028
<b>NISSEN</b> Arterienklemmen	243	<b>PARTSCH-LANGE</b> Raspatorien	1052
<b>NORFOLK &amp; NORWICH</b> Wundspreizer, selbsthaltend	453	<b>PASSOW</b> Stößel	1024
Notfallkoffer	28	Patellazangen	1117
<b>NOTO</b> Polypen und Ovarienzangen	357	<b>PAUL</b> Wundhaken	444
<b>NOTT</b> Scheidenspekulas	883	<b>PAYR</b> Darmklemmen	854
<b>NOVAK</b> Biopsieküretten	912	<b>PAYR</b> Führungshohlsonden	512
<b>NOYES</b> Mikro-Scheren	140	<b>PEAN</b> Arterienklemmen	238-241
<b>NUBOER</b> Saugrohre	78	<b>PECK-JOSEPH</b> Feine chirurgische Scheren	123
<b>NUSSBAUM</b> Darmklemmen	849	<b>PEDERSON</b> Scheidenspekulas	883, 884
<b>O</b>		<b>PEERS-BERTRAM</b> Tuchklemmen	369
<b>O'BRIEN</b> Feine chirurgische Scheren	128	<b>PEET</b> Splitterzangen	1208
<b>OBWEGESER</b> Blattosteotome	1035	<b>PELKMANN</b> Kornzangen	355
<b>OBWEGESER</b> Elevatorien	1056	<b>PELTESON</b> Watteträger	633
<b>OBWEGESER</b> Interdentale Osteotome	1036	<b>PENFIELD</b> Duradissectoren	812
<b>OBWEGESER</b> Keilosteotome	1035	Penisklemmen	946
<b>OBWEGESER</b> Kinnhalter	383, 1057	<b>PENNINGTON</b> Darm- und Gewebefasszangen	362
<b>OBWEGESER</b> Osteotome	1035, 1036	<b>PENNINGTON</b> Septumelevatorien	676
<b>OBWEGESER</b> Progenierinnen	1057	<b>PENNYBACKER</b> Hohlmeißelzangen	1131
<b>OBWEGESER</b> Ramushaken	386	<b>PENNYBACKER</b> Laminektomie-Zangen	1004
<b>OBWEGESER</b> Raspatorien	1058, 1059	<b>PENNYBAKER</b> Duradissectoren	813
<b>OBWEGESER</b> Raspeln	1088	<b>PERCY</b> Amputationsretraktoren	1008
<b>OBWEGESER</b> Spaltungsosteotome	1035	Perforatorien	748, 937





Periostmesser	735
Peritoneumklemmen	277-279
<b>PERKINS</b> Wundspreizer, selbsthaltend	448
Perkussionshämmer	16,17
<b>PERTHES</b> Reibahlen	1012
<b>PESTALLOZZA</b> Plazenta- und Abortuslöffel	942
Petrischalen	1214
<b>PETZ</b> Darm- und Magenklammen	860
Pflasterspatel	66
Phalangenmesser	52
<b>PHANEUF</b> Hysterektomieklammen	273
Phlebodissektor	814
Phleboextraktor	814
<b>PIERCE</b> Kieferhöhlentroker	70
<b>PIERCE</b> Septumelevatorien	676
<b>PINARD</b> Foetal-Stethoskope	17
Pinzetten	194-229
Pinzetten mit Hartmetalleinsätzen	232-236
<b>PIPER</b> Geburtszangen	934
<b>PITHA</b> Kornzangen	352
<b>PITHA</b> Mundkeil	619
Plazenta- und Abortuslöffel	942
Plazenta- und Abortuszangen	939-941
<b>PLESTER</b> Antrumhäkchen	747, 748
<b>PLESTER</b> Exkavator	747
<b>PLESTER</b> Führungsgabel	747
<b>PLESTER</b> Häkchen	747
<b>PLESTER</b> Lappenmesser	745
<b>PLESTER</b> Saugrohre	77
<b>PLESTER</b> Schaber	748
<b>PLESTER</b> Sichelmesser	745
<b>PLESTER</b> Wundspreizer, selbsthaltend	448
<b>POLITZER</b> Furunkelmesser	735
<b>POLITZER</b> Luftduschen	716, 717
<b>POLITZER</b> Ohrspekulas	721
<b>POLITZER</b> Parazentesenadeln	736
<b>POLLOSON</b> Wundhaken	410
Polypen und Ovarienzangen	356, 357
Polypenschnürer	671
<b>POOLE</b> Saugrohre	82,83
<b>POPLITEA</b> Bauchdeckenhalter	465
<b>POTTS</b> Atraumatische Gefäßklammen	307, 308, 315, 319, 320
<b>POTTS-DE MARTEL</b> Gefäßscheren	136
<b>POTTS-DE MARTEL</b> SCT Gefäßscheren	192
<b>POTTS-SMITH</b> Anatomische Pinzetten	201
<b>POTTS-SMITH</b> Anatomische TC Pinzetten	233
<b>POTTS-SMITH</b> Chirurgische Pinzetten	213
<b>POTTS-SMITH</b> Gefäßscheren	117
<b>POTTS-SMITH</b> Gefäßscheren	133, 136, 158
<b>POTTS-SMITH</b> Gefäßscheren	136
<b>POTTS-SMITH</b> TC Gefäßscheren	179
<b>POZZI</b> Hakenzangen	902
Präparier- und Ligaturklammen	260-270, 280-281
Präparierscheren	108-115, 154-156
<b>PRATT</b> Analspreizer	861
<b>PRATT</b> Hakenzangen	907
<b>PRATT</b> Kieferhöhlenküretten	690
<b>PRATT</b> Peritoneumklemmen	277
<b>PRATT</b> Sonden	64
<b>PRECISA</b> Blutdruckmessgeräte	24
<b>PRINCE</b> Tonsillenscheren	116
<b>PRINCE-THOMAS</b> Bronchusklemmen	802
<b>PRINCE-THOMAS</b> Lungenfaßzangen	801
Progenierinnen	1057
Proktoskope	862, 864
Prostatahaken	953
<b>PROVIDENCE-HOSPITAL</b> Arterienklammen	249
Prüf und Messinstrumente	20-22
Pulverbläser	718
<b>PUTTI</b> Raspeln	1089
<b>Q</b>	
<b>QUATTRO</b> Gipsspreizer	1194
<b>QUERVAIN</b> Elevatorien	1074
<b>QUINBY</b> Zahnfleischschere	124
<b>QUINKE</b> Leberblindpunktkanülen	74
<b>QUIRE</b> Fremdkörperhebel	731
<b>R</b>	
<b>RABINER</b> Perkussionshammer	17
Rack für Rhoton Instrumente	839
<b>RADOLF</b> Nagelzangen	1206
<b>RAGNELL</b> Wundhaken	419
<b>RAGNELL-DAVIS</b> Wundhaken	440
<b>RAKE</b> Wundhaken	486

<b>RALK</b> Handbohrapparate	1172, 1173
<b>RALK</b> Splitterzangen	1208
<b>RAMPLEY</b> Schwammzangen	359
Ramushaken	386
<b>RANDALL</b> Biopsieküretten	912
<b>RANDALL</b> Nierenfistelzangen	876
<b>RANDALL</b> Nierensteinzangen	875
<b>RANEY</b> Klammerzangen	546
<b>RANEY</b> Kopfhautklammern	546
Rasierklingen	47, 1207
Rasierklingen-Brecher und -Halter	825
Rasiermesser	58
Raspatorien	562, 563, 704, 708, 752, 831, 832, 835, 1052-1055, 1058-1071
Raspeln	1088, 1089
<b>RAY</b> Kürette	703
<b>RECAMIER</b> Uterusküretten	925, 926, 928
<b>REDON</b> Führungsnadeln	66-68
Reflexspiegel	35
Reibahlen	1012
<b>REICHERT</b> Kehlkopfdeckelhalter	633
<b>REILL</b> Drahtkniefzangen	1164
<b>REILL</b> Repositionszangen	1116
<b>REINER</b> Gipsmesser	1195
Reinigungsbürste	1227
Rektum-Anastomoseklammen	855-859
Rektum-Biopsiezangen	869
Rektumscheren	106, 107
Repositionszangen	1115
<b>RESANO</b> Kapselscheren	105
<b>RESANO</b> Rektum-Anastomoseklammen	859
Resektionsmesser	53, 54
Retraktoren zur Fixation am Schädel	540-542
<b>REVERDIN</b> Bauch- und Darmspatel	421
<b>REVERDIN</b> Unterbindungsnadeln	500
<b>REYNOLDS</b> Präparierscheren	114, 156
<b>REYNOLDS</b> SCT Präparierscheren	189
<b>REYNOLDS</b> TC Präparierscheren	172, 173
Rhinoplastik-Messer	672, 673
Rhinoskopie Spiegel	632
<b>RHOTON</b> Dissektor	840
<b>RHOTON</b> Elevator	840
<b>RHOTON</b> Häkchen	841
<b>RHOTON</b> Kugeldissektor	840
<b>RHOTON</b> Löffel	840, 841
<b>RHOTON</b> Nadel	841
<b>RIBBON-IRIS</b> Feine chirurgische Scheren	130
<b>RIBBON-STEVENS</b> Feine chirurgische Scheren	130
<b>RICARD</b> Bauchdeckenhalter	468
<b>RICHARDSON</b> Wundhaken	412
<b>RICHARDSON-EASTMAN</b> Wundhaken	411
<b>RICHNAU-HOLMGREN</b> Ohrspekulas	726
<b>RICHTER</b> Chirurgische Scheren	97
<b>RICHTER-HEATH</b> Wundklammerzangen	518
<b>RIENHOFF</b> Rippensperr	782
<b>RIGBY</b> Wundspreizer, selbsthaltend	458
<b>RING</b> Zungendrucker	616
Ringküretten	1111
Ringmesser	628, 629
Ringstripper	808
Rippenkontraktoren	800
Rippenscheren	764-768
Rippensperr	769-799
Rippensperr aus Aluminium	769-776
<b>RI-RAP</b> Stethoskope	19
<b>RITTER</b> Stirnhöhlen-Dilatatoren	753
<b>ROBB</b> Gefäßdissektoren	814
<b>ROBERTS</b> Präparier- und Ligaturklammen	269
<b>ROBIN MASSE</b> Bauchdeckenhalter	465
<b>ROBIN</b> Tuchklammen	367
<b>ROCHARD</b> Bauchdeckenhalter	477
<b>ROCHESTER-CARMALT</b> Arterienklammen	245
<b>ROEDER</b> Ligaturinstrument	627
<b>ROEDER</b> Tuchklammen	368
<b>ROETTGEN-RUSKIN</b> Hohlmeißelzangen	1134
<b>ROGER</b> Septumelevatorien	676
<b>ROGERS</b> Hysterektomieklammen	275, 276
<b>ROGGE</b> Sterilisierzangen	1209
<b>ROLLET</b> Wundhaken	432
Rollmesser	746
<b>ROSCHKE</b> Analspreizer	864
<b>ROSE</b> Wundhaken	419
<b>ROSEN</b> Fenestrierhäkchen	747
<b>ROSEN</b> Lanzettenmesser	747

ROSEN Löffel	747	Schleimhautmesser	745
ROSEN Mikro-Nadel	748, 749	SCHLESINGER Laminektomie-Zangen	1006
ROSEN Raspatorium	747	Schließklemmen	860
ROSEN Rundschnittmesser	746	SCHMEDEEN Nasenzangen	992
ROSEN Saugrohre	85	SCHMID Gefäß Spülkanülen	73
ROSER-KOENIG Mundsperrler	604	SCHMID Intimaspatel	813
ROSS Aortahaken	816	SCHMIEDEN Führungshohlsonden	511
ROUX Wundhaken	416	SCHMIEDEN Unterbindungsadeln	502
ROUX-MAGNUS Wundhaken	417	SCHMIEDEN-DICK Unterbindungsadeln	501
RUBIN Osteotome	681	SCHMIEDEN-PAYR Führungshohlsonden	511
RUBIN Septumzangen	701	SCHMIEDEN-TAYLOR Gefäßscheren	133
RUDD Hämorrhoidal-Ligatoren	867	SCHNEIDER Raspatorien	1064
RUMEL Präparier- und Ligaturklemmen	267	SCHNEIDER-SAUERBRUCH Raspatorien	1065
RUMEL-BELMONT Fadenfänger	815	SCHNIDT Arterienklemmen	244
RUMEL-BELMONT Krampfaderinstrumente	815	SCHNIDT Tonsillenfasszangen	620
Runde Schalen	1212, 1214	Schnürröhre	624, 652, 671, 738
Rundkopfstanzan	756	SCHOEMAKER Darmklemmen	852
Rundschnittmesser	746, 752, 753	SCHOEMAKER-LOTH Ligaturscheren	147
RUSKIN Hohlmeißelzangen	1133	SCHOENBORN Trachealhäkchen	656
RUSKIN Kieferhöhlentrockar	87	SCHROEDER Fistelmesser	56
RUSKIN-LISTON Knochensplitterzangen	1142	SCHROEDER Hakenzangen	901, 903, 907
RUSSEL-DAVIS Zungendrucker	615	SCHROEDER Uteruslöffel	924
RUSSIAN Gewebefasspinzetten	203	SCHUBERT Uterus-Biopsiezangen	916, 917
RUST Amputations- und Resektionssägen	1009	SCHUHKNECHT Biegegerät zum Formen von Drahtprothesen	686
RYDEL-SEIFFER Stimmgabeln	713	SCHUHKNECHT Saugrohre	89
RYDER Nadelhalter	498	SCHUKNECHT Mikro-Drahtbiegezängchen	741
RYDER-VASCULAR TC Nadelhalter	532	SCHUKNECHT Rollmesser	746
<b>S</b>		SCHUKNECHT Sichelmesser	746
SAALFELD Komedoneninstrument	61	SCHUL Diskektomie-Spreizer	594
SACHS Dura-Dissektoren	550, 551	SCHULTZE Salpingograph	915
SACHS Durahaken	554	SCHUMACHER Broncho-Oesophagoskopiezangen	637
SACHSE Meatotom	948	SCHUMACHER Nabelschnurschere	102
SAENGER Plazenta- und Abortuszangen	941	SCHUMACHER Rippenscheren	764
SALENIUS Meniskusmesser	1146	SCHUMACHER Uterus-Biopsiezangen	920
Salpingograph	915	SCHUMACHER-VAN DOREN Uterus-Biopsiezangen	918
SALYER Face-lift Scheren	118	Schwammzangen	359
SAMII Lanzettenmesser	837	SCHWEDEEN Scharfe Löffel	1091
SAMII Tumormesser	836, 837	Schwestern garnitur	1207
SANTULLI Bulldogklemmen	296	Schwingmesser	679
SANVENERO Feine chirurgische Scheren	124	SCOVILLE Laminektomie-Wundsperrler	558
SAROT Nadelhalter	490	SCOVILLE Nervwurzelhaken	552
SAROT Präparier- und Ligaturklemmen	267	SCOVILLE Scharfe Löffel	1106
SAROT TC Nadelhalter	524	SCOVILLE Seitenvalven	557, 558
SATINSKY Atraumatische Gefäßklemmen	332	SCOVILLE Wundhaken	486
SATINSKY Gefäßscheren	131	SCOVILLE-HAVERFIELD Laminektomie-Wundsperrler	557
SATINSKY Vena-Cava-Klemmen	347, 348	SCOVILLE-RICHTER Laminektomie-Wundsperrler	556
SATTERLEE Amputations- und Resektionssägen	1010	SCOVILLE-RICHTER Seitenvalven	565
SAUERBRUCH Abfallzangen	1218	SCT Gefäßscheren	191
SAUERBRUCH Nadeldosen	1223	SCT Nasenscheren	189, 190
SAUERBRUCH Rippenscheren	765	SCT Präparierscheren	187
SAUERBRUCH Wundhaken	382, 394	SCT Uterusscheren	186
SAUERBRUCH-CORYLLOS Hohlmeißelzangen	1140	SCUDDER Magenklemmen	851
SAUERBRUCH-FREY Rippenscheren	767	SEBILEAU Elevatorien	1074
Saug- und Spülinstrumente	86-89	SEDILLOT Raspatorien	1063
Saugelevatortien	674, 678	SEDILLOT Raspatorien	1065
Saughandgriffe	85	SEEMANN-SEIFERT Mundsperrler	605
Saugrohre	77-89	SEGOND Myommesser	56
SAUNDERS Instrument für die Entfernung von Spiralen	911	SEGOND-LANDAU Hysterektomieklennnen	273
SAWTELL Tonsillenfasszangen	620	Sehndurchzieh-zangen	1150-1152
SCALP-CONTOUR Wundspreizer, selbsthaltend	446	Sehnenflecht-klemmen	1150-1152
Schaber	748	Sehnenführer	1153
Schädelhalter	548	Sehnenmesser	745
Schädelspalter	1021	Sehnen-schäler	1152, 1153
Schädelszangen	549	SEIDL Scheidenspekulas	887
SCHAEDEL Tuchklemmen	368	SEIFFERT Broncho-Oesophagoskopiezangen	637
SCHAMBERG Komedoneninstrument	61	Sekretlöffel	911
Scharfe Löffel	751	SELDIN Raspatorien	1064
Scharfe Löffel	1091-1114	SELLHEIM Geburtslöffel	936
Scharfes Häkchen	830	SELLORS Rippenkontraktoren	800
SCHEDER Scharfe Löffel	1095	SELMANN Fasspinzette	204
SCHIEBE Darm- und Gewebefasszangen	362	SELVERSTONE Laminektomie-Zangen	998, 999
Scheidenspekulas	880-895	SEMB Bronchusklemmen	802
SCHIEINMANN Broncho-Oesophagoskopiezangen	637	SEMB Hohlmeißelzangen	1139
SCHERBACK Scheidenspekulas	894	SEMB Knochenhalte-zange	1119
Scheren	91-148	SEMB Knochensplitterzangen	1144
Scheren für die plastische Chirurgie	115	SEMB Raspatorien	1066
Scheren mit Hartmetallschneiden	160-181	SEMKEN Anatomische Pinzetten	199, 200
SCHIMMELBUSCH Verbandstoff-trommeln	1224	SEMKEN Anatomische TC Pinzetten	232
SCHINDLER Peritoneumklemmen	279	SEMKEN Chirurgische Pinzetten	208, 212
SCHINK Dermatome	59	SEMKEN Chirurgische TC Pinzetten	234, 235
SCHINK Spannplatte	59	SEMM Bauchdeckenhalter	474
SCHIOETZ Tonometer	23	SEMM Scheidenspekulas	882
Schlauchklemmen	370-371	SENN-GREEN Wundhaken	438



<b>SENNING</b> TC Nadelhalter	523	<b>SPREADY</b> Laminektomie-Spreizer	589-591
<b>SENN-MILLER</b> Wundhaken	439	Spreizzange für Spekulas	702
Septumelevatoren	674-678	Spritzen	74-76
Septum-Hohlmeißel	679	<b>SPURLING</b> Laminektomie-Zangen	997
Septumkanülen	72	Sputumbecher	1214
Septummesser	672, 673	<b>ST. CLAIR-THOMSON</b> Ringmesser	629
Septumscheren	700	<b>ST. MARKS</b> Wundhaken	420
Septumzangen	696-699, 701	<b>ST. MARKS</b> Analspreizer	866
Sequesterzangen	1118	<b>STACKE</b> Knopfsonden	62
<b>SEUTIN</b> Verband- und Gipsscheren	1191	<b>STANDARD</b> Trokare	69
<b>SEWALL</b> Raspatorien	1052	Standgefäße	1213
<b>SEWALL</b> Raspatorien	1060	Staubinden	29
<b>SEXTON</b> Parazentesenadeln	735	<b>STAUDE-MOORE</b> Hakenzangen	901
<b>SEYFFERT</b> Scheidenspekulas	882	Stechbecken	1215
Seziermesser	54, 55	Steigbügelhäkchen	747
<b>SHAAF</b> Cilienpinzetten	223	<b>STEINBACH</b> Hämmer	1018
<b>SHAMBAUGH</b> Mikro-Häkchen	749	Steinzangen	945
<b>SHAMBOUGH</b> Tonsillotome	630	<b>STELLA</b> Face-lift TC Scheren	175
<b>SHAPLEIGH</b> Ohrschlingen	729	<b>STELLBRINK</b> Hohlmeißelzangen	1127
<b>SHEA</b> Scharfe Löffel	751	<b>STELZNER</b> Rektumscheren	107
<b>SHEEHAN</b> Osteotome	682	Sterilisier- und Lagerungsgestell	1225
Sichelmesser	691, 745, 746, 748, 752	Sterilisierklammern	372
Siebbeinzangen	745	Sterilisierzangen	1209
<b>SIEGLE</b> Ohr lupen	726	Sternalpunktionkanülen	73
Silberklammern	546	<b>STERNBERG</b> Lippen- und Wangenhalter	618
Silberklammernblock	546	Sternnummeißel	764
<b>SILVER</b> Dermatom	59	Stethoskope	17-19
<b>SILVER</b> Osteotome	683	<b>STEVENS</b> Feine chirurgische Scheren	127, 156
<b>SIMON</b> Fistelmesser	56	<b>STEVENS</b> Feine chirurgische SCT Scheren	191
<b>SIMON</b> Scharfe Löffel	1100	<b>STEVENS</b> Irispinzetten	197, 208
<b>SIMON</b> Wundhaken	414	<b>STIEGLITZ</b> Splitterzangen	1208
<b>SIMON</b> Wundhaken	415, 436	Stiellupen	23
<b>SIMPLEX</b> Wangenhalter	619	<b>STILLE</b> Anatomische Pinzetten	197
<b>SIMPSON</b> Geburtszangen	932, 933	<b>STILLE</b> Chirurgische Pinzetten	207
<b>SIMPSON-LUIKART</b> Geburtszangen	934	<b>STILLE</b> Flachmeißel	1032
<b>SIMS</b> Analspreizer	861	<b>STILLE</b> Gallensteinzangen	878
<b>SIMS</b> Mastdarmspekulas	862	<b>STILLE</b> Gipsscheren	1192
<b>SIMS</b> Scheidenspekulas	887	<b>STILLE</b> Handbohrapparate	1171
<b>SIMS</b> SCT Uterusscheren	186	<b>STILLE</b> Hohlmeißel	1033
<b>SIMS</b> TC Uterusscheren	163, 164	<b>STILLE</b> Hohlmeißelzangen	1136
<b>SIMS</b> Uterus-Depressor	900	<b>STILLE</b> Nierenstielklemmen	283, 285
<b>SIMS</b> Uterusküretten	900, 927, 930	<b>STILLE</b> Osteotome	1032
<b>SIMS</b> Uterusscheren	98, 99, 151	<b>STILLE-BARRAYA</b> Gefäß- und Tumorphinzetten	216
<b>SIMS</b> Uterussonden	899	<b>STILLE-RUSKIN</b> Hohlmeißelzangen	1138
<b>SIMS-BODENHAMMER</b> Analspreizer	861	<b>STILLE-SHERMAN</b> Handbohrapparate	1171
<b>SIMS-MAIER</b> Kornzangen	355	Stimmgabeln	713-715
<b>SIMS-SIEBOLD</b> Uterusscheren	100, 152	Stirnband	35
<b>SINGLEY-TUTTLE</b> Gewebefasspinzetten	204	Stirnhöhlen-Dilatatoren	753
Sinusklemmen	352	Stirnhöhlenstanzen	695
Sinuskope	599, 712	Stirnlampen	26-27
Sinuskopie-Instrumente	703-708	<b>STOCKMANN</b> Fixationsklemmen	946
Sinuskopie-Trokare	692	<b>STOCKMANN</b> Penisklemmen	946
Skalpellgriffe	44-47, 50, 823, 825, 826	<b>STONE</b> Chirurgische Pinzetten	218
Skalpellklingen	48, 50	<b>STONE-WATT</b> Darm- und Magenklemmen	860
Skalpellklingen-Entferner	48	<b>STONE-WATT</b> Schließklemme	860
<b>SKENE</b> Hakenzangen	903	Stößel	1024
<b>SLUDER-BALLENGER</b> Tonsillotome	625	<b>STRABISMUS</b> Präparierscheren	112
<b>SMELLIE</b> Dekapitationshaken	937	<b>STRANDELL-STILLE</b> Wundhaken	441
<b>SMELLIE</b> Perforatorien	937	<b>STRASSBURG</b> Chirurgische Pinzetten	212
<b>SMILLIE</b> Meniskussmesser	1147	<b>STRATTE</b> Nadelhalter	492
<b>SMILLIE</b> Wund- und Meniskushaken	1148	<b>STRATTE</b> TC Nadelhalter	526
<b>SMITH</b> TC Drahtscheren	180	<b>STRAUSS</b> Penisklemmen	946
<b>SMITH</b> Verbandscheren	1186	<b>STRONG (COBRA)</b> Atraumatische Gefäßklemmen	318
<b>SMITH-BUIE</b> Analspreizer	864	<b>STRUCK</b> Rippensperrer	782
<b>SMITH-PETERSEN</b> Hohlmeißel	1040	<b>STRUEMPEL</b> Ohrzängchen	734
<b>SMITH-PETERSEN</b> Hohlmeißelzangen	1134	<b>STRULLY</b> Gefäßscheren	131
<b>SMITH-PETERSEN</b> Osteotome	1039	<b>STRUYKEN</b> Nasenzangen	990
<b>SMITHWICK</b> Durahaken	554	<b>SUBRAMANIAN</b> Atraumatische Gefäßklemmen	299
<b>SNELLEN</b> Ohrschlingen	728	<b>SUPERCUT</b> Scheren	150-158
<b>SOMER</b> Uterusfaßzangen	909	<b>SUPERCUT TITAN-NITRIT</b> Scheren	184-192
Sonden	62-64	<b>SWEDISH</b> Dura-Dissektoren	550
Spaltungsosteotome	1035	<b>SWEET</b> Klammerzangen	547
Spannplatte	59	<b>SYPERT</b> Hohlmeißelzangen	1140
Spekula für lumbale Bandscheibenoperationen	585	<b>SYPERT</b> Laminektomie-Stanzen	985
Spekulas für Hypophysektomie	702	<b>SYPERT</b> Laminektomie-Zangen	987
<b>SPENCER-WELLS</b> Arterienklemmen	242	<b>SYSTRUNK</b> Nagelscheren	1204
Spezialkanülen	72-74	<b>T</b>	
Sphinkteroskope	863	<b>TABB</b> Schleimhautmesser	745
Spinal Hohlmeißel	1050	<b>TAKAHASHI</b> Laminektomie-Zangen	994
Splitterpinzetten	224-225	<b>TAKAHASHI</b> Nasenzangen	757
Splitterzangen	1208	Tampon- und Polypenzangen	669, 670
Spongiosa Hohlmeißel	1045	Tamponstopfer	626
<b>SPRATT</b> Scharfe Löffel	1097	Tamponzangen	353

TARNIER Geburtszangen	935	Trokare	69-71
TARNIER Kranioklast	938	TROUSSEAU Trachealdilatator	654
TAYLOR Anatomische Pinzetten	200, 201	TROUTMAN-CHRIS Klängenbrecher	47
TAYLOR Chirurgische Pinzetten	212, 213	TROUTMAN-CHRIS Klängenhalter	47
TAYLOR Perkussionshammer	16	TUBBS Aorta-Dilatatoren	810
TAYLOR Seitenvulven	558	Tuchklemmen	367-369
TAYLOR Wund- und Meniskushaken	1148	TUEBINGEN Gallensteinzangen	878
TAYLOR-BROWN Chirurgische Pinzetten	216	TUEBINGEN Mikropinzetten	227
TC Drahtscheren	180	TUEBINGEN Mikro-Scheren	140
TC Gefäßscheren	179, 180	TUEBINGEN Wundhaken	414
TC Hysterektomiescheren	166	TUEBINGEN Wundspreizer, selbsthaltend	449
TC Ligaturscheren	181	TUFFIER Darm- und Gewebefaßzangen	365
TC Nahtpinzette	236	TUFFIER Rippensperrer	780
TC Nasenscheren	174	TUFFIER Wundhaken	403
TC Präparierscheren	167-173	Tumorgabeln	828
TC Tonsillenscheren	174	Tumormesser	836, 837
TC Uterusscheren	163, 164	Tunneliererset	811
TC Zahnfleischscheren	177, 178	Tupferzangen	349-352, 354, 355
TEALE Hakenzangen	904	TURNBULL Nagelzangen	1205
TERRIER Arterienklemmen	259	TYDING Tonsillenschnürer	624
TESSIER Knochenformzange	1118	TYDING-TIVNEN Tonsillenfasszangen	621
TESSIER Nasenscheren	120	<b>U</b>	
TESSIER Osteotome	1033, 1036, 1037	UCKERMANN Tracheal Trokar	653
TESSIER Raspatorien	1058	UCKERMANN Watteträger	65
THILENIUS Tonsillenabszesszange	623	UFFENORDE Scharfe Löffel	1114
THOMS-ALLIS Darm- und Gewebefaßzangen	364	Uhrmacher Pinzetten	228
THOMS-GAYLOR Uterus-Biopsiezangen	919	ULMER Notfallkoffer	28
THOMSON-WALKER Blasenwundspreizer	952	ULRICH Fistelmesser	56
THOREK Präparierscheren	113	ULRICH Knochenhaltezange	1122
THOREK TC Präparierscheren	171	ULRICH Tupferzangen	349
THUDICHUM Nasenspekulas	660	UNIVERSAL Drahtscheren	148
TIECK-HALLE Nasenspekulas	660, 661	UNIVERSAL Sterilisierzangen	1209
Tiefenmeßsonde	748	UNIVERSAL TC Drahtscheren	180
TILLEY Tampon- und Polypenzangen	669	UNIVERSAL Trokare	69
TILLEY-HENCKEL Nasenzangen	989	UNIVERSAL Verband- und Gipsscheren	1191
TISCHLER Uterus-Biopsiezangen	917	Universalgriff	636, 923
TISCHLER Uterus-Biopsiezangen	921	UNNA Komedoneninstrument	61
TISCHLER-KEVORKIAN Uterus-Biopsiezangen	921	UNNA-VIDAL Komedoneninstrument	61
TISCHLER-MORGAN Uterus-Biopsiezangen	921, 922	Unterbindungsadeln	500-509, 626
TOBOLD Kehlkopfpolypenzangen	634	Unterkieferkörperhaken	1057
TOBOLD Zungendrucker	601	Ureterzangen	945
TOENNIS Arterienklemmen	243, 255	Urethrotom	954
TOENNIS Durahaken	555	Urinale	1216
TOENNIS Duramesser	57, 58	USA Anatomische Pinzetten	196
TOENNIS Intimaspatel	814	USA Chirurgische Pinzetten	206
TOENNIS Nadelhalter	497	USA Gipsspreizer	1194
TOENNIS Präparierscheren	114	USA Nabelschnurschere	102
TOENNIS TC Nadelhalter	531	USA Scharfe Löffel	1108, 1109
TOENNIS-ADSON Präparierscheren	115	Uterus-Kanüle	915
TOENNIS-ADSON SCT Präparierscheren	189	Uterus-Biopsiezangen	916-923
TOENNIS-ADSON TC Präparierscheren	173	Uterus-Depressor	900
TOHOKU Tuchklemmen	369	Uterus-Dilatatoren	897
Tonometer	23	Uterusfaßzangen	909, 910
Tonsillenabszesszange	623	Uterusklemmzange	936
Tonsillendissektoren	622, 623	Uterusküretten	900, 925-930
Tonsillenfasszangen	620	Uteruslöffel	911, 924
Tonsillinkanülen	72	Uterusscheren	98-100, 151, 152
Tonsillennmesser	57, 623	Uterussonden	899
Tonsillennmesser und Enukleator	622	<b>V</b>	
Tonsillennadeln	626	VALLEIX Uterussonden	899
Tonsillenscheren	116, 117	VAN BUREN Dilatationsbougies	950
Tonsillenschnürer	623, 624	VAN BUREN Sequesterzangen	1118
Tonsillotome	625, 630	VAN DOREN Uterus-Biopsiezangen	918, 919
TOWNLEY Messzirkel	22	VANNAS Mikro-Scheren	140
TOYNEE Ohrspekulas	725	VARADY Krampfaderbesteck	807
Tracheal Trokare	653	VARADY Mikro Dissektor	814
Trachealdilatatoren	654	VARADY Phlebo-dissektor	814
Trachealhäkchen	655	VARADY Phleboextraktor	814
Tracheal-Kanülen	654, 655	VASCULAR Nadelhalter	498
Tränenkanalsonden	62, 63	VEDDER Tonsillenschnürer	624
Transformatoren	27, 42-43	VEIDENHEIMER Rektum-Anastomoseklemmen	857
Transplantationsmesser	58	Vena-Cava-Klemmen	347, 348
TRAUBE Perkussionshammer	17	Venenkanülen	72
TRAUTMANN Flachmeißel	1029	Verband- und Gipsscheren	1186-1192
TRAUTMANN Hohlmeißel	1029	Verbandstofftrommeln	1224
TRAVERS Wundspreizer, selbsthaltend	456	VERBRUGGE Knochenhaltezange	1124
TRELAT Raspatorien	1053	VERHOEVEN Saugrohre	89
TRELAT Scheidenspekulas	882	VERRES Insufflationskanüle	73
TREVES Chirurgische Pinzetten	216	VICKERS Bohrhandgriffe	1156
Trigeminusmesser	56, 57	VICKERS Dissektoren	1052
TROELTSCH Ohr- und Nasenpinzetten	221	VICKERS Elevatorien	1052
TROELTSCH-JALASVIRTA Ohr- und Nasenpinzetten	221	VICKERS Finger-Wundspreizer	1183
TROEMMER Perkussionshammer	16	VICKERS Handhalter	1182



VICKERS Wundhaken	428	WIEN Nasenspekulas	662
VICKERS Wundspreizer	1183	WIEN Kieferhöhlenraspeln	693
VIDAL Lupusschaber	60	WIEN MOD. Hysterektomieklappen	274
VIENNA Fadenfänger	513	WIGMORE Gipsmesser	1195
Vigorimeter	21	WIKSTROEM Präparier- und Ligaturklappen	269
VIRCHOW Hirnmesser	55	WILDER Tränenkanalsonden	63
VIRCHOW Schädelspalter	1021	WILLET Kopfschwartzange	936
VIRCHOW Seziermesser	54	WILLET-MARTEL Darm- und Gewebefaßzangen	366
VOLKMANN Scharfe Löffel	1092, 1096, 1104, 1105	WILLIAMS Darm- und Gewebefaßzangen	360
VOLKMANN Wundhaken	374, 378	WILLIAMS Wundspreizer, selbsthaltend	464
VOLLMAR Gefäß Spülkanülen	73	WILLIGER Elevatorien	1074
VOLLMAR Ringstripper	808	WILLIGER Hämmer	1016
VOLTOLINI Nasenspekulas	660	WILLIGER Raspatorien	1053
Vomerzangen	696, 697	WILLIGER Scharfe Löffel	1094, 1096
Vorderrandstripper	1057	WILLIGER Wundhaken	420
Vulvaspreizer	896	WILMER-WALTER Nasenscheren	122
<b>W</b>		WILSON Hakenzangen	904
WACHENFELDT Wundklammerpinzetten	517	Winkelmesser	20
WAGNER Wundhaken	429	WINTER Plazenta- und Abortuszangen	939, 940
WAGNER Biegeinstrumente	1170	Wirbelkörperspreizer	592, 593
WAGNER Feine chirurgische Scheren	125, 126	Wirbelsäulen KIT	482
WAGNER Feine chirurgische TC Scheren	177	WIS-FOREGGER Laryngoskope	39
WAGNER Hämmer	1014	WITTNER Uterus-Biopsiezangen	920
WAGNER Hohlmeißel	1049	WOLFF Gipspreizer	1194
WAGNER Knochenheber	1076, 1080, 1081	WOLFF Lupusküretten	60
WAGNER Laminektomie-Zangen	985, 986	WOODSON Duradisektoren	812
WAGNER Raspatorien	1070	WRIGLEY Geburtszangen	935
WALB Organmesser	55	WUERZBURG Zungendrucker	616
WALDMANN Damm Scheren	101, 152	WULLSTEIN Mikro-Löffelzängchen	739
WALDMANN Damm TC Scheren	162	WULLSTEIN Raspatorien	1054
WALDMANN Episiotomie Scheren	101, 152	WULLSTEIN Saughandgriff	85
WALDMANN Episiotomie TC Scheren	162	WULLSTEIN Saugrohre	77, 86
WALLICH Uteruslöffel	911	WULLSTEIN Wundspreizer, selbsthaltend	447
WALTER Flachmeißel	682	Wund- und Meniskushaken	1148, 1149
WALTER Hohlmeißel	1033	Wundhaken	374-486
WALTER Nasenflügelhäkchen	688	Wundklammern	516
WALTER Osteotome	682	Wundklammerpinzetten	517, 518
WALTON Fingerringssägen	1011	Wundklammerzangen	517, 518
WALTON Rektum-Biopsiezangen	869	Wundspreizer für die cervicale Wirbelsäule	568-581
WALTON-YANKAUER Saugrohre	81	Wundspreizer für die lumbale Wirbelsäule	582-585
Wangenhalter	619	Wundspreizer, selbsthaltend	445-464
WANGENSTEEN Anatomische TC Pinzetten	233	<b>Y</b>	
WANGENSTEEN Gewebefasspinzetten	204	YANKAUER Saugrohre	81, 82
WANGENSTEEN Nadelhalter	494	YASARGIL Dissektor	835
WANGENSTEEN TC Nadelhalter	527	YASARGIL Fadenführer	829
WARTENBERG Algesimeter	20	YASARGIL Galeahaken	545
WARTENBERG Nervrädchen	20	YASARGIL Gefäßmesser	838
Wasserstrahl-Reinigungspistole	1226	YASARGIL Laminektomie-Zangen	1005
WASSMUND Wundhaken	380	YASARGIL Raspatorium	835
WATSON Dermatome	59	YASARGIL Saugrohre	80
WATSON-CHEYNE Dissektoren	1056	YASARGIL-NICOLA Mikro-Faßzange	651
WATSON-JONES Knochenheber	1076	YEOMANN Rektum-Biopsiezangen	869
WATSON-WILLIAMS Nasenzangen	993, 994	YOUNG Prostatahaken	953
Wattespender	1217	YOUNG Zungenzangen	618
Watteträger	65, 66, 633, 653	YOUNG-HRYNTSCHAK Unterbindungsnadeln	513
WAUGH Chirurgische Pinzetten	206	<b>Z</b>	
WEBER Ästhesiometer	20	Zahnfleischscheren	124, 125
WEBER Atraumatische Gefäßklappen	312	ZANDER Reibahlen	1012
WEBER-LOCH Ohrschlingen	729, 730	Zangenschloß	936
WEBSTER Nadelhalter	491	ZAUFAL Ohrhebel	730
WEBSTER TC Nadelhalter	525	ZAUFAL-JANSEN Hohlmeißelzangen	1133
WECKER Mikro-Scheren	139	ZAUFAL-JANSEN Ohrhäkchen	731
Weichteilhaken	384, 385	Zeckenpinzetten	226
WEIL-BLAKESLEY Nasenzangen	988, 989	ZENKER Präparier- und Ligaturklappen	262, 263
WEIL-BLAKESLEY Siebbeinzangen	745	ZENKER Wundhaken	391
Weisheitszahnhaken	387	Zerstäuber	761
WEISMAN Ohrküretten	729	Zerumenlöffel und Häkchen	730
WEISSBARTH Scheidenspekulas	895	Zerumnadel und Watteträger	730
WEITLANER Wundspreizer, selbsthaltend	446, 447, 453, 454	ZIEGLER Cilienpinzetten	223
WEITLANER-BABY Wundspreizer, selbsthaltend	449	ZIEGLER Duramesser	57
WELLER Meniskus- und Knorpelfaßzangen	1145	ZIEGLER Reflexspiegel	35
WERTHEIM Hysterektomieklappen	271, 272	ZIELKE Hohlmeißel	1044
WERTHEIM Rektum-Anastomoseklappen	859	ZOELLNER Führungsgabel	752
WERTHEIM TC Hysterektomiescheren	166	ZOELLNER Häkchen	752
WERTHEIM Uterusscheren	100	ZOELLNER Lanzettenmesser	752
WERTHEIM-CULLEN Hysterektomieklappen	276	ZOELLNER Mikro-Nadel	752
WEST Flachmeißel	1025	ZOELLNER Nasenspekulas	720
WEST Hohlmeißel	1025	ZOELLNER Raspatorium	752
WESTCOTT Mikro-Scheren	141	ZOELLNER Rundschnittmesser	752
WESTMACOTT Tampon- und Polypenzangen	669	ZOELLNER Saugrohre	89
WHITE Tonsillenfasszangen	620	ZOELLNER Sichelmesser	752
WHITEHEAD Mundsperrer	604	Z-PARAMETRIUM Hysterektomieklappen	286
WIEDER Zungendrucker	602	Zughebel	936



Zugendrucker	601, 602, 615, 616
Zungenspatel	600
Zungenzangen	618
Zwischenknochenmesser	53



<b>A</b>			
Abdominal and intestinal spatulas	421	ASCH Secretion scoop	911
Abdominal retractors	465-477	ASH Septum forceps	698
Abdominal scissors	97, 98	Atomizers	761
<b>ABRAHAM</b> Tonsil grasping forceps	621	Atraumatic vascular clamps	299-346
<b>ABRAHAM</b> Tonsil knife	57	Atrial blade introducer	820
Abscess knife	57	Atrial blades	820
Adenoid curettes	628, 629	Atrial blades holders	820
Adenotomes	630	Atrial Retractor	792, 797, 824
<b>ADLERDYCE</b> Elevators	1055	Atrium retractors	816
<b>ADLERKREUTZ</b> Vascular and tumor forceps	214	<b>AUFRICHT</b> Nasal rasps	1085, 1090
<b>ADSON</b> Bone rongeurs	1131	<b>AUFRICHT</b> Nasal retractors	687
<b>ADSON</b> Dissecting forceps	198, 199	<b>AUFRICHT</b> Plastic surgery scissors	115
<b>ADSON</b> Dissecting TC forceps	232	Aural magnifier	726, 727
<b>ADSON</b> Drill guide forceps	1012	Autopsy knives	54, 55
<b>ADSON</b> Dura hooks	554, 555	<b>AUVARD</b> Vaginal speculas	895
<b>ADSON</b> Haemostatic forceps	245, 256	<b>AYRE</b> Cone knife	56
<b>ADSON</b> Needle holders	489	<b>B</b>	
<b>ADSON</b> Raspatories	1059	<b>BABCOCK</b> Intestinal and tissue grasping forceps	362, 363
<b>ADSON</b> Reamers	1012	<b>BABINSKY</b> Percussion hammer	17
<b>ADSON</b> Suction tubes	78	<b>BABY-ADSON</b> Dissecting and ligature forceps	269
<b>ADSON</b> Tissue forceps	209, 210	<b>BABY-ALLIS</b> Intestinal and tissue grasping forceps	363
<b>ADSON</b> Tissue TC forceps	234	<b>BABY-COLLIN</b> Abdominal retractors	466
<b>ADSON</b> Wound spreaders, self retaining	453, 455, 458-461	<b>BABY-CRILE</b> Haemostatic forceps	248, 257
<b>ADSON-BIEMER-MICRO</b> Tissue forceps	211	<b>BABY-CRILE-WOOD</b> TC Needle holders	523
<b>ADSON-BROWN</b> Tissue forceps	217	<b>BABY-KOCHER</b> Intestinal forceps	844
<b>ADSON-BROWN</b> Tissue TC forceps	235	<b>BABY-MIKULICZ</b> Peritoneum forceps	277
<b>ADSON-DE BAKEY</b> Non-traumatic tissue forceps	218	<b>BABY-MIXTER</b> Dissecting and ligature forceps	270
<b>ADSON-GRAEFE</b> Tissue forceps	217	<b>BABY-MOSQUITO</b> Haemostatic forceps	251
<b>ADSON-MICRO</b> Dissecting forceps	199	<b>BABY-OVERHOLT</b> Dissecting and ligature forceps	270
<b>ADSON-MICRO</b> Dissecting TC forceps	232	<b>BABY-ROUX</b> Retractors	416
<b>ADSON-MICRO</b> Tissue forceps	210, 211	<b>BABY-SATINSKY</b> Vena cava clamps	347
<b>ADSON-MICRO</b> Tissue TC forceps	234	<b>BABY-TISCHLER</b> Cervical biopsy and specimen forceps	921
<b>ADSON-MINI</b> Tissue forceps	210	<b>BABY-YANKAUER</b> Suction tubes	81
Aesthesiometer	20	<b>BACKHAUS</b> Towel clamps	367
<b>AGNEW</b> Tympanum perforator	736	<b>BACKHAUS-KOCHER</b> Towel clamps	367
Air bags	716, 717	<b>BACON</b> Bone rongeurs	1129
Air blower	75	<b>BAGDLEY</b> Laminectomy retractors	559
<b>ALAN-PARKS</b> Rectal retractors	865	<b>BAILEY</b> Laminectomy rongeurs	1007
Alar nasal hooklets	688, 689	<b>BAILEY-GIBBON</b> Rib contractors	800
<b>ALDINGER</b> Bone levers	1081	<b>BAINBRIDGE</b> Atraumatic vascular clamps	314
<b>ALEXANDER</b> Cervical biopsy and specimen forceps	920	<b>BAINBRIDGE</b> Haemostatic forceps	246
<b>ALEXANDER</b> Chisels	1030	<b>BAKES</b> Gall duct dilators	872
<b>ALEXANDER</b> Gouges	1030	<b>BALFOUR</b> Abdominal retractors	470
<b>ALEXANDER</b> Raspatories	1065	<b>BALFOUR</b> Retractors	485
Algesimeter (pinwheel)	20	<b>BALFOUR USA</b> Abdominal retractors	471
Algesimeter with needle and brush	20	<b>BALFOUR-BABY</b> Abdominal retractors	469
<b>ALLEN</b> Intestinal forceps	844	<b>BALL &amp; SOCKET</b> Towel clamps	368
<b>ALLIS</b> Intestinal and tissue grasping forceps	363, 364	<b>BALLENGER</b> Septum gouges	679
<b>ALLIS-ADAIR</b> Intestinal and tissue grasping forceps	365	<b>BALLENGER</b> Swivel knives	679
<b>ALLISON</b> Lung spatulas	800	<b>BALLENGER</b> Tonsil grasping forceps	621
<b>ALM</b> Wound spreaders, self retaining	446	<b>BALLENGER-HAJEK</b> Septum elevators	676
<b>ALY</b> Algesimeter	20	Bandage and plaster-of-paris scissors	1186-1192
Aminoscopes	864	<b>BARANY</b> Noise drum	716
Amniotome	903	<b>BARBARA</b> Micro needle	748, 749
Amputating knives	52	<b>BARNES</b> Suction tubes	88
Amputation and resection saws	1009, 1010	<b>BARNHILL</b> Adenoid curettes	629
Amputation retractors	1008	<b>BARON</b> Suction tubes	88
Anastomosis clamp forceps	845	<b>BARR</b> Rectal retractors	861
<b>ANDERSON-ADSON</b> Wound spreaders, self retaining	453	<b>BARRAQUER</b> Cilia forceps	223
<b>ANESTOPHONE</b> Stethoscope	19	<b>BARRAQUER</b> Micro scissors	140
<b>ANKENEY</b> Rib Spreader	774, 783	<b>BARRON</b> Hemorrhoidal ligators	867
Anterior border stripper	1057	<b>BARSKY</b> Retractors	442
Antrum curettes	690-692	<b>BARTH</b> Bone curettes	1092
Antrum hook	747	<b>BARTH</b> Ear curettes	730
Antrum irrigation cannulas	88	Battery charging device	42
Antrum punches	693-695	<b>BAUMGARTNER</b> Wire forceps	1159
Antrum rasps	693	<b>BAYHA</b> Scalpel handles	44
Antrum scoops	691, 692	<b>BAYONET-KERRISON</b> Laminectomy punches	968-975
Antrum trocars	69, 70, 87	<b>BEACHAM</b> Amniotome	903
Anuscopes	862, 863	<b>BEALE</b> Hook	748
<b>ANVIL</b> Nail nippers	1206	<b>BEALES</b> Tendon knife	745
Aorta dilators	810	<b>BECK</b> Laminectomy rongeurs	994
Aorta punches	811	<b>BECKMANN</b> Adenoid curettes	628
Aorta retractors	816, 817	<b>BECKMANN</b> Nasal speculas	662
Applying forceps for bulldog clamps	293, 296	<b>BECKMANN</b> Wound spreaders, self retaining	459
Areola marker	21	<b>BECKMANN-ADSON</b> Wound spreaders, self retaining	462
<b>ARKANSAS</b> Sharpening stones	58	<b>BECKMANN-EATON</b> Wound spreaders, self retaining	463
Arm systems	478, 479	Bed pans	1215
<b>ARRUGA</b> Needle holders	496	<b>BEEBEE</b> Wire cutting scissors	148
<b>ARRUGA</b> TC Needle holders	531	<b>BEER</b> Cilia forceps	223
Artery forceps	238-260	<b>BEESON</b> Plaster spreaders	1193
Abdominal KIT II	481	<b>BELLUCCI</b> Micro ear scissors	740
		Bending instruments	1170

<b>BENNETT</b> Bone levers	1082	<b>BRAUN</b> Uterine tenaculum forceps	901, 908
<b>BENGOLEA</b> Haemostatic forceps	243, 255	<b>BRAUN</b> Vaginal speculas	892
<b>BENSAUDE</b> Anuscopes	862	<b>BRAUN-STADLER</b> Episiotomy scissors	101
<b>BENSON</b> Intestinal forceps	852	<b>BRAUN-STADLER</b> Perineum scissors	101
<b>BERGER</b> Cervical biopsy and specimen forceps	920	<b>BREISKY</b> Vaginal speculas	894
<b>BERGMANN</b> Bandage and plaster-of-paris scissors	1190	<b>BREISKY WIENER</b> Vaginal speculas	894
<b>BERGMANN</b> Dissecting knives	51	<b>BRIDGE</b> Dissecting and ligature forceps	264
<b>BERGMANN</b> Mallets	1015	<b>BRODIE</b> Directors	64
<b>BERGMANN</b> Plaster saws	1195	<b>BROM</b> Retractors	431
<b>BERGMANN</b> Retractors	434	Broncho-Oesophagoscopy forceps	636
<b>BERLIN</b> Biopsy curettes	913	Bronchoscopy	658, 659
<b>BERLIN</b> Tubing clamps	370	Bronchus clamps	802
<b>BERLINER</b> Percussion hammers	16	<b>BROPHY</b> Dissecting forceps	202
<b>BERNHARD</b> Towel clamps	368	<b>BROPHY</b> Tissue forceps	214
<b>BERTILON</b> Caliper	20	<b>BROWN</b> Needle holders	490
<b>BETHUNE</b> Rib shears	765	<b>BROWN</b> Tissue grasping forceps	217
<b>BEYER</b> Bone rongeurs	1130	<b>BRUENINGS</b> Aural magnifier	727
<b>BEYER</b> Bone rongeurs	1133	<b>BRUENINGS</b> Broncho-Oesophagoscopy forceps	637
<b>BIEMER</b> Vessel spreader	827	<b>BRUENINGS</b> Elongation tubes	636
<b>BILL</b> Traction handle	936	<b>BRUENINGS</b> Septum forceps	697
<b>BILLEAU</b> Ear loops	729	<b>BRUENINGS</b> Septum knife	672
Biopsy curettes	912-914	<b>BRUENINGS</b> Tongue spatulas	600
Biopsy nasal forceps	755	<b>BRUENINGS</b> Tonsil knife	57
<b>BIRCHER</b> Knee retractors	1148	<b>BRUENINGS</b> Tonsil snares	623
<b>BIRCHER</b> Meniscus and cartilage grasping forceps	1145	<b>BRUENINGS-BRUNK</b> Nasal retractors	687
<b>BIRCHER</b> Meniscus knives	1147	<b>BRUENINGS-LUCAS</b> Chisels	1029
<b>BIRCHER-GANSKE</b> Meniscus and cartilage grasping forceps	1145, 1146	<b>BRUENINGS-LUCAS</b> Gouges	1029
<b>BIRKETT</b> Haemostatic forceps	249	<b>BRUNETTI</b> Chisel	1049
Bladder neck spreader	953	<b>BRUNNER</b> Ligature conductors	509, 511
Bladder retractors	952	<b>BRUNNER</b> Ligature needles	502, 509
Bladder spatulas	953	<b>BRUNNER</b> Retractors	396-398, 415
Blade breakers	47	<b>BRUNNER</b> Rib shears	768
Blade holders	47	<b>BRUNNER</b> Sigmoid anastomosis forceps	855
Blade osteotomes	1035	<b>BRUNS</b> Bandage and plaster-of-paris scissors	1190, 1191
<b>BLAKE</b> Gall stone forceps	877	<b>BRUNS</b> Bone curettes	1095, 1106, 1107
<b>BLAKESLEY</b> Septum forceps	757	<b>BRYANT</b> Dressing forceps	352
<b>BLAKESLEY-WIGAND</b> Nasal forceps	991	<b>BUCHWALD</b> Tongue spatulas	600
<b>BLOHMKE</b> Tonsil grasping forceps	621	<b>BUCK</b> Ear curettes	728
Blood collector	29	<b>BUCK</b> Foreign body forceps	731
Blood pressure manometers	24-25	<b>BUCK</b> Ligature scissors	147
<b>BLOUNT</b> Knee retractors	1149	<b>BUCK</b> Myringotome	735
<b>BLUMENTHAL</b> Bone rongeurs	1128	<b>BUCK</b> Percussion hammer	16
<b>BOEHLER</b> Bone cutting forceps	1142	<b>BUCK-GRAMCKO</b> Bone levers	1075
<b>BOEHLER</b> Bone rongeurs	1132	<b>BUECHS</b> Raspatories	1063
<b>BOERMA</b> Obstetrical forceps	934	<b>BUELAU</b> Trocars	70
<b>BOETTCHER</b> Tonsil scissors	116	Bulldog clamps	288-297
<b>BOIES</b> Nasal fracture elevators	698	<b>BUMM</b> Polypus and ovum forceps	356
<b>BONACCOLTO</b> Suture forceps	198	<b>BUMM</b> Uterine curettes	928, 929
Bone and joint spreader	1184	<b>BUNNELL</b> Hand drills	1172
Bone clamps	1126	<b>BUNNELL</b> Tendon stripper	1152, 1153
Bone contouring forceps	1118	<b>BUNT</b> Safety pins	372
Bone curettes	1091-1114	<b>BURFORD</b> Rib Spreader	775-777
Bone cutting forceps	1141-1144	<b>BURKE</b> Cervical biopsy and specimen forceps	920
Bone holding forceps	1117-1125	<b>BUSCH</b> Umbilical cord scissors	102
Bone levers	1075-1083	<b>BUSHE</b> Bone curettes	1113
Bone rongeurs	1126-1140	Buttoned probe	827, 828
Bone wires	1157	<b>C</b>	
<b>BONN</b> Delicate surgical scissors	129	Caesarean section haemostatic forceps	936
<b>BONN</b> Micro forceps	227	<b>CAIRNS</b> Haemostatic forceps	251
<b>BONNEY</b> Dissecting forceps	203	Caliper	20, 22, 559
<b>BONNEY</b> Dissecting TC forceps	233	Callosity Plane	1207
<b>BONNEY</b> Intestinal and tissue grasping forceps	360	<b>CANADIAN</b> Meniscus knives	1147
<b>BONNEY</b> Tissue forceps	215	<b>CAPLAN</b> Septum scissors	700
<b>BONNEY</b> Tissue TC forceps	235	Capsula scissors	105
<b>BOROWSKI</b> Aorta retractors	817	Capsule forceps	955
<b>BOSE</b> Tracheal retractor	655	<b>CARDIOBASE</b> Rib Spreader	798, 799
<b>BOSE</b> Wound spreaders, self retaining	445	<b>CARDIOPHONE</b> Stethoscope	19
<b>BOUCHERON</b> Ear speculas	723	Cardioplegia needle	823
<b>BOWLES</b> Stethoscope	18	<b>CARMALT</b> Splinter forceps	225
<b>BOWMAN</b> Lachrymal probes	62	<b>CAROLL</b> Finger goniometer	20
<b>BOYNTON</b> Needle holders	497	<b>CAROLL</b> Tendon passing forceps	1151
<b>BOYS-ALLIS</b> Intestinal and tissue grasping forceps	365	<b>CARPENTER</b> Tonsil dissectors	622
<b>BOZEMANN</b> Needle holders	493	<b>CARPENTER</b> Tonsil knife and enucleator	622
<b>BOZEMANN</b> TC Needle holders	526	<b>CARREL</b> Haemostatic forceps	251
<b>BOZEMANN</b> Uterine dressing forceps	353	Cartilage crusher	686
<b>BOZEMANN</b> Vascular scissors	131	Cartilage knives	53, 54
<b>BOZEMANN-DOUGLAS</b> Uterine dressing forceps	353	Cartilage scissors	115, 116
Brain knives	55	Cartilage slitting knife	672
Brain spatulas	543, 544	<b>CASPAR</b> Cervical vertebral body distraction system	560, 561
<b>BRAND</b> Tendon passing forceps	1152	<b>CASPAR</b> Bone curettes	1101-1103
<b>BRAUN</b> Cranioclast	938	<b>CASPAR</b> Caliper	559
<b>BRAUN</b> Decapitating Hooks	937	<b>CASPAR</b> Curettes	1110
<b>BRAUN</b> Uterine depressor	900	<b>CASPAR</b> Dissector	832, 833





CASPAR Exploration & coagulation hook	834	COLCLOUGH Laminectomy punches	984
CASPAR Laminectomy retractors	564-567	COLLER Haemostatic forceps	246
CASPAR Laminectomy rongeurs	987, 1000-1004	COLLIER Needle holders	492
CASPAR Laminectomy rongeurs, detachable	1002, 1003	COLLIN Abdominal retractors	466, 467
CASPAR Ligature pusher	828	COLLIN Clip applying forceps	518
CASPAR Nerve root retractors	552	COLLIN Dressing forceps	354
CASPAR Raspatories	562, 563	COLLIN Dynamometer	20
CASPAR Retractors	388	COLLIN Intestinal and tissue grasping forceps	361
CASPAR Retractors for cervical spine	568-579	COLLIN Mallets	1016
CASPAR Retractors for lumbar vertebral column	582, 584	COLLIN Pelvimeter	931
CASPAR Scalpel handles	825	COLLIN Retractors	420
CASPAR Specula for lumbar vertebral operations	585	COLLIN Scalpel handles	47
CASPAR Tampers	1024	COLLIN Toungue holding forceps	618
CASTANEDA Neonatal vascular clamps	298-299	COLLIN Umbilical cord clamp	937
CASTANEDA Rib Spreader	773, 774	COLLIN Uterine grasping forceps	910
CARSTENS Trocars	70	COLLIN Vaginal speculas	880
CASTROVIEJO Blade breakers	47	COLLIN-DUVAL Tissue forceps	204
CASTROVIEJO Blade holders	47	COLLIN-HARTMANN Retractors	416
CASTROVIEJO Lachrymal probes	63	COLLIN-LOKTITE Abdominal retractors	467
CASTROVIEJO Micro forceps	226	COLLYER Pelvimeter	931
CASTROVIEJO Micro scissors	138, 139	Columella forceps	686
Catheter guide	947	Comedone extractor	61
Catheter introducing forceps	944	Compression bandages	29
Catheter introducing instruments	947	Comprimeter	29
CATLIN Amputating knives	52	Conductors for wire saws	549
CAWOOD-MINNESOTA Lip and cheek retractors	618	CONE Cranial rongeur forceps	549
Cerclage instruments	1158	Cone knife	56
Cerumen pick and woolcarier	730	CONE Ring curettes	1111
Cerumen scop and hook	730	CONVERSE Alar nasal hooklets	688
Cervical biopsy and specimen forceps	916-923	CONVERSE Nasal retractors	687
Cervical traction tongs	548	CONVERSE Osteotomes	682
Cervical vertebral body distraction system	560, 561	CONVERSE Rhinoplastic knives	673
CHADWICK Delicate surgical scissors	123	COOLEY Aorta dilators	810
Channel retractors	1057	COOLEY Atraumatic vascular clamps	304, 305, 326, 330, 335-339, 342-345
CHAPUT Intestinal and tissue grasping forceps	366	COOLEY Atrial Retractor	797
CHARNLEY Abdominal retractors	475	COOLEY Atrium retractors	816
CHARRIÈRE Amputation and resection saws	1009	COOLEY Non-traumatic tissue forceps	219, 220
CHEATTLE Sterilising Forceps	1209	COOLEY Rib Spreader	769-771, 788, 789
Cheek retractors	619	COOLEY Suction tubes	83
CHELSEA Proctoscopes	862	COOLEY Vascular dilators	808
CHERON Sponge forceps	354	COOLEY-BECK Atraumatic vascular clamps	340
Chest support	638	COOLEY-LEITZ Atraumatic vascular clamps	340
Chest support for all mouth gags	617	COOPER Ligature needles	502
CHEVALIER Rib Spreader	781	COPE Retractors	440
CHEVALIER-JACKSON Trachea tubes	655	CORDES Broncho-Oesophagoscopy forceps	637
CHILDE Clip applying forceps	517	CORWIN Wire forceps	1160
Chin retractor	383, 1057	CORYLLOS Retractors	395
Chisels	680-682, 751, 1025-1051	CORYLLOS Rib shears	766
CHURCH Vascular scissors	132	COTTLE Alar nasal hooklets	688, 689
Cilia forceps	223	COTTLE Cartilage crusher	686
CINELLI Osteotomes	683	COTTLE Chisels	680, 681
Circular cutting punches	756	COTTLE Columella forceps	686
Circumcision instruments	956	COTTLE Fixation forceps	686
CITELLI Laminectomy punches	958	COTTLE Mallets	1013
CITELLI-BEYER Laminectomy punches	958	COTTLE Nasal rasps	1084
Clamp closing forceps	845	COTTLE Nasal retractors	690
Clamp holder	845	COTTLE Nasal scissors	120, 122
CLAR Head lamps	26	COTTLE Nasal speculas	666-668
CLASSON Vascular scissors	132	COTTLE Osteotomes	680, 1031
CLAUS V. EICKEN Tonsil needle	626	COTTLE Raspatories	1060
Cleaning brush	1227	COTTLE Rhinoplastic knives	673
Cleft palate needles	626	COTTLE Septum elevators	677, 678
CLEVELAND Bone cutting forceps	1141	COTTLE Tonsil TC scissors	174
CLEVELAND Bone rongeurs	1128	COTTLE-KAZANJIAN Bone cutting forceps	1141
Clip applying forceps	517, 518	COTTLE-KNAPP Nasal scissors	122
Clip applying forceps ETHICON	518	COTTLE-MASING Nasal scissors	122
Clip instruments	546, 547	COTTLE-NEIVERT Alar nasal hooklets	689
Closing forceps	860	COTTLE-WALSHAM Septum forceps	698, 699
CLOVER Tonsil grasping forceps	620	Cotton applicators	65, 66, 633, 653
CLOWARD Lamina spreaders	592, 593	Cotton dispenser	1217
CLOWARD Laminectomy rongeurs	1006	COUPLAND Suction tubes	82
CLOWARD Nerve root retractors	553	Cover glass forceps	226
CLOWARD Retractors for cervical spine	580, 581	CRAFOORD Dissecting and ligature forceps	266
Coagulation suction tube	87	CRAFOORD Gynaecological scissors	101
COAKLEY Antrum curettes	690-692	CRAFOORD-SELLORS Dissecting and ligature forceps	266
COAKLEY Antrum trocar	71	CRAIG Septum forceps	696
COBB Curettes	1112	Cranial rongeur forceps	549
COBB Elevators	1072, 1073	Cranioclast	938
COBB Spinal gouge	1050	CREDO Callosity Plane	1207
COBETT Dermatome	59	CRILE Haemostatic forceps	248, 258
COBRA Atraumatic vascular clamps	318	CRILE Needle holders	497
COEN Uterine cannula	915	CRILE Retractors	419, 430
COHEN Raspatories	1055	CRILE-MURRAY Needle holders	490

CRILE-RANKIN Haemostatic forceps	246, 257	DEMEL Wire guides	1158
CRILE-WOOD Needle holders	490	DENHARDT Mouth gags	603
CRILE-WOOD TC Needle holders	522	DENNIS-BROWNE Abdominal retractors	471
CRUTCHFIELD Cervical traction tongs	548	DENNIS-BROWNE Tissue grasping forceps	204
Curettes	703, 704, 706-708, 831, 832, 840, 841, 1110-1112	DERF (WRIGHT) Needle holders	491
CUSCO Vaginal speculas	880-882	DERF TC Needle holders	525
CUSHING Brain spatulas	543	DERF-CONVERSE Needle holders	492
CUSHING Dissecting forceps	202	DERF-CONVERSE TC Needle holders	525
CUSHING Dissecting TC forceps	233	Dermal punch	60, 61
CUSHING Dura hooks	555	Dermatology	60, 61
CUSHING Laminectomy rongeurs	995, 998	Dermatomes	59
CUSHING Retractors	430, 437, 441, 444	DERRA Atraumatic vascular clamps	304
CUSHING Tissue forceps	213	DESCHAMPS Ligature needles	503-508
CUSHING-BROWN Tissue forceps	216	DESJARDINS Gall stone forceps	878
CUSHING-KOCHER Retractors	437	DESJARDINS Gall stone probes	872
CUSHING-LANDOLT Specula for hypophysectomy	702	DESJARDINS Gall stone scoopes	873
CUZZI Placenta and ovum scoops	942	DESJARDINS Kidney pedicle clamps	282
CZERNY Rectal retractors	861	DESMARRES Retractors	436
CZERNY Retractors	420	Diagnostic sets	30-35
CZERNY Uterine tenaculum forceps	906	DICK Hysterectomy Forceps	276
<b>D</b>		DIEFFENBACH Bulldog clamps	292
DAHLGREN Cranial rongeur forceps	549	DIETER Malleus Punches	744
DAHMEN Gouges	1051	DIETRICH Bulldog clamps	291
DAHMEN Osteotomes	1051	DIETRICH Atraumatic vascular clamps	334
DALE Atraumatic vascular clamps	329	DIETRICH-VASCULAR TC Needle holders	532
DANDY Dura hooks	554	Dilating bougies	949, 950
DANDY Haemostatic forceps	249, 258	DINGMANN Bone holding forceps	1117
DANDY Vascular scissors	132	DINGMANN Mouth gags	606
DARDIK Atraumatic vascular clamps	346	DINGMANN Tongue depressors	615
DARLING Wound spreaders, self retaining	452	DIPLOMAT Blood pressure manometers	25
DARTIGUES Uterine grasping forceps	909	Directors	63
DAUBENSPECK Bone curettes	1099	Discectomy retractors	594
DAUTREY-MUNRO Osteotomes	1034	Discision knife	745
DAVIDSON Retractors	411	Dishes	1214
DAVIS Intima spatula	813	Disposable Scalpels	49
DAVIS Sterilising Forceps	1209	Dissecting and ligature forceps	260-270, 280-281
DAVIS-BOYLE Mouth gags	608-612	Dissecting forceps	194-204
DAVIS-BOYLE Tongue depressors	616	Dissecting knives	51
DAVIS-MEYER Mouth gags	607	Dissecting scissors	108-115, 154-156
DAVIS-MEYER Tongue depressors	616	Dissectors	703, 708, 753, 831, 832, 835, 840, 1052, 1056
DAY Ear hooks	731	DITTEL Catheter guide	947
DE BAKEY Atraumatic vascular clamps	300-303, 309-311, 313, 314, 316, 317, 321, 322, 325, 328, 330	DIXON-LOVELACE Haemostatic forceps	247, 257
DE BAKEY Bulldog clamps	288, 289	DOCKHORN Retractors	387
DE BAKEY Dissecting scissors	115	DOUAY Cervical biopsy and specimen forceps	920
DE BAKEY Non-traumatic tissue forceps	219, 220	DOUGHTY Tongue depressors	615
DE BAKEY Non-traumatic tissue TC forceps	236	DOUGLAS Antrum trocar	71
DE BAKEY Rib Spreader	786, 787	DOUGLAS Cilia forceps	223
DE BAKEY Suction tubes	84	DOYEN Abdominal retractors	480
DE BAKEY TC Needle holders	522, 523	DOYEN Abdominal scissors	97, 98
DE BAKEY Vascular dilators	809	DOYEN Directors	63
DE BAKEY Vascular scissors	134, 135	DOYEN Intestinal forceps	844-847
DE BAKEY Vascular TC scissors	179	DOYEN Myoma screws	908
DE BAKEY Wound spreaders, self retaining	464	DOYEN Needle holders	492
DE BAKEY-BAHNSON Atraumatic vascular clamps	310	DOYEN Polypus and ovum forceps	356
DE BAKEY-BECK Atraumatic vascular clamps	305	DOYEN Raspatories	1066, 1067
DE BAKEY-CAROTIS Bulldog clamps	297	DOYEN Retractors	402
DE BAKEY-DIETRICH Bulldog clamps	294	DOYEN Tongue depressors	602
DE BAKEY-MIXTER Atraumatic vascular clamps	300	DOYEN Towel clamps	368
DE BAKEY-MOSQUITO Atraumatic vascular clamps	307	DOYEN Vaginal speculas	893
DE BAKEY-PEAN Atraumatic vascular clamps	306	DOYEN-CHILD Abdominal retractors	480
DE BAKEY-RANKIN Atraumatic vascular clamps	307	DOYEN-COLLIN Mouth gags	603
DE BAKEY-RUMEL Atraumatic vascular clamps	300	DOYEN-JANSEN Mouth gags	603
DE BAKEY-SATINSKY Atraumatic vascular clamps	331	DOYEN-STILLE Retractors	408
DE BAKEY-SATINSKY Bulldog clamps	297	DRAFFIN Holding frame for mouth gags	617
DE LEE Obstetrical forceps	932	Dressing forceps	349-352, 354, 355
DE MARTEL Conductors for wire saws	549	Dressing forceps with tungsten carbide inserts	232-236
DE MARTEL-WOLFSON Anastomosis clamp forceps	845	Drill guide forceps	1012
DE MARTEL-WOLFSON Clamp closing forceps	845	Drill Handles	1156, 1157
DE MARTEL-WOLFSON Clamp holder	845	DUBOIS Decapitating scissors	100
DE VILBISS Cranial rongeur forceps	549	DUEHRSEN Dissecting forceps	203
DEAN Tonsil scissors	116	DUEHRSEN Tissue forceps	215
DEAN Tonsil TC scissors	174	DUKE Trocars	71
DEAVER Retractors	426, 427, 485	DUNN-DAUTREY Osteotomes	1026
DEAVER Surgical scissors	96	DUPLAY Dressing forceps	351, 352
Decapitating Hooks	937	DUPLAY Uterine tenaculum forceps	902
Decapitating scissors	100	DUPLEX Stethoscopes	18
DECKER Laminectomy rongeurs	1006	DUPUY-WEISS Ligature needles	626
DEJERINE Percussion hammers	16	Dura dissectors	812, 813
Delicate surgical scissors	123-130, 156-157	Dura hooks	554, 555
Delicate surgical SCT scissors	190	Dura knives	57, 58, 553
Delicate surgical TC scissors	177, 178	Dura-dissectors	550, 551
DEMEL Cerclage instruments	1158	DURANTE Vascular and tumor forceps	218
		DUVAL Intestinal and tissue grasping forceps	360, 361



<b>DUVAL</b> Tissue forceps	204
<b>DUVAL-COLLIN</b> Intestinal and tissue grasping forceps	361
Dynamometer	20
<b>E</b>	
Ear and nasal dressing forceps	221, 222
Ear catheters	716
Ear curettes	728-730
Ear forceps	732-734
Ear hooks	730, 731
Ear levers	730
Ear loops	728-730
Ear polypus forceps	732
Ear polypus snares	738
Ear speculas	720-726
Ear syringes	719
<b>ECHLIN</b> Bone rongeurs	1135
<b>EDER</b> Cotton applicators	66
<b>EICKEN</b> Antrum irrigation cannulas	88
<b>EISELSBERG</b> Ligature scissors	147
<b>EISELSBERG</b> Needle holders	497
Elevators	737, 840, 1052-1056, 1072-1074
<b>ELSAESSER</b> Nephrostomy forceps	876
Emergency case	28
<b>EMMET</b> Dressing forceps	354
<b>EMMET</b> Retractors	436
Empyema trocar	70
Endolaryngeal micro surgery	642-651
Endospeculas	896
<b>ENGEL</b> Plaster saws	1195
Enterotomy scissors	103
Enucleators	705
Epicardial retractors	817
Epiglottis retractor	633
Episiotomy scissors	101, 102, 152
Episiotomy TC scissors	162
<b>EPPENDORF</b> Cervical biopsy and specimen forceps	920, 922
<b>ESMARCH</b> Bandage and plaster-of-paris scissors	1190
<b>ESMARCH</b> Plaster knives	1195
Ethmoid forceps	745
<b>EVES</b> Tonsil snares	623
<b>EWALD</b> Dissecting forceps	198
<b>EWALD</b> Tissue forceps	209
Examination and measuring instruments	20-22
Excavator	747
Exploration & coagulation hook	834
<b>F</b>	
Face-lift scissors	117
Face-lift SCT scissors	190
Face-lift TC scissors	175, 176
<b>FAHLBUSCH</b> Curette	707
<b>FAHLBUSCH</b> Micro scissors	651
<b>FANSLER</b> Anuscopes	862
<b>FARABEUF</b> Bone holding forceps	1120
<b>FARABEUF</b> Raspatories	1063
<b>FARABEUF</b> Retractors	417
<b>FARABEUF-COLLIN</b> Raspatories	1063
<b>FARABEUF-LAMBOTTE</b> Bone holding forceps	1120
<b>FARRELL</b> Cotton applicators	65
<b>FARRIOR</b> Ear speculas	720, 724
<b>FAULKNER</b> Antrum curettes	690
<b>FAURE</b> Cervical biopsy and specimen forceps	916
<b>FAURE</b> Hysterectomy Forceps	272
<b>FAURE</b> Peritoneum forceps	278
<b>FAVALORO</b> Vascular scissors	134
<b>FAVALORO</b> Rib Spreader	775
<b>FEHLAND</b> Sigmoid anastomosis forceps	856
<b>FEILCHENFELD</b> Splinter forceps	225
<b>FEIN</b> Cotton applicators	633
<b>FELDHEIM</b> Tourniquet	1181
Fenestra hook	747
<b>FERGUSON</b> Bone holding forceps	1119
<b>FERGUSON</b> Gall stone scoopes	874
<b>FERGUSON</b> Intestinal forceps	853
<b>FERGUSON</b> Sigmoid anastomosis forceps	855
<b>FERGUSON</b> Suction tubes	78, 79
<b>FERGUSON</b> Surgical scissors	97
<b>FERGUSON-ACKLAND</b> Mouth gags	603
<b>FERRIS-SMITH</b> Tissue forceps	215
<b>FERRIS-SMITH</b> Tissue TC forceps	235
<b>FERRIS-SMITH-CUSHING</b> Laminectomy rongeurs	979-983
<b>FERRIS-SMITH-CUSHING</b> Laminectomy rongeurs, detachable	981, 983
<b>FERRIS-SMITH-KERRISON</b> Laminectomy punches	960-967, 978
Fetal stethoscopes	17

<b>FICKLING</b> Dissecting and ligature forceps	269
<b>FILIFORM</b> Dilating bougies	949
Finger goniometer	20
Finger nail drill	1207
Finger protector	619
Finger retractor	1183
Finger ring saws	1011
Finger ring hooks	689
<b>FINOCHIETTO</b> Dissecting and ligature forceps	280
<b>FINOCHIETTO</b> Needle holders	494
<b>FINOCHIETTO</b> Rib Spreader	771-773, 784, 785
<b>FINOCHIETTO</b> TC Needle holders	527
<b>FINSEN</b> Wound spreaders, self retaining	445
<b>FINSTERER</b> Suction tubes	84
<b>FISCHER</b> Tendon stripper	1153
<b>FISCHER</b> Tonsil knives	623
Fistula knives	56
Fixation clamps	946
Fixation forceps	686
Flap knife	745
Flexible naso-pharyngo-laryngofiberscope	598
Flexometer	20
<b>FOERSTER</b> Sponge forceps	359
<b>FOERSTER-BALLENGER</b> Sponge forceps	359
<b>FOMON</b> Alar nasal hooklets	688, 689
<b>FOMON</b> Finger-ring hooks	689
<b>FOMON</b> Nasal rasps	1086, 1090
<b>FOMON</b> Nasal scissors	118, 119, 121
<b>FOMON</b> Nasal SCT scissors	189
<b>FOMON</b> Osteotomes	683
<b>FOMON</b> Rhinoplastic knives	672
<b>FOMON</b> Tonsil TC scissors	174
Forceps	194-229
<b>FORD-DIXON</b> Hemorrhoidal ligators	868
Foreign body forceps	731, 948
Foreign body instruments	731
Foreign body lever	731
<b>FORMBY</b> Cerumen scoop and hook	730
<b>FOSTER-GILLIES</b> TC Needle holders	528
<b>FOWLER</b> Tonsil knife	57
<b>FOX</b> Lupus curettes	60
<b>FRAENKEL</b> Broncho-Oesophagoscopy forceps	637
<b>FRAENKEL</b> Laryngeal polypus forceps	634, 635
<b>FRANCKE</b> Blood collector	29
<b>FRANZ</b> Abdominal retractors	474
<b>FRASER-KELLY</b> Haemostatic forceps	248
<b>FRAZIER</b> Dura hooks	555
<b>FRAZIER</b> Dura-Dissectors	551
<b>FRAZIER</b> Suction tubes	77
<b>FRAZIER</b> Ventricel of cerebrum puncture cannulas	80
<b>FREEMAN-GORNEY</b> Face-lift TC scissors	176
<b>FREEMAN-KAYE</b> Face-lift TC scissors	176
<b>FREER</b> Chisels	1025
<b>FREER</b> Elevators	1054
<b>FREER</b> Gouges	1025
<b>FREER</b> Mucosa knife	673
<b>FREER</b> Retractors	443
<b>FREER</b> Septum elevators	674, 675
<b>FREER-GORNEY</b> Suction elevator	674
<b>FREER-JOSEPH</b> Septum elevators	675
<b>FREER-YASARGIL</b> Septum elevators	674
<b>FRENZEL</b> Tongue spatulas	600
<b>FRIEDMANN-JOLL</b> Vulva spreader	896
<b>FRIEDMANN-MINI</b> Bone rongeurs	1127
<b>FRIEDMANN-VICKERS</b> Bone rongeurs	1127
<b>FRITSCH</b> Retractors	403
Frontal sinus bougies	753
Frontal sinus punches	695
<b>FRY</b> Nasal forceps	990
<b>FRYKHOLM</b> Bone rongeurs	1136
<b>FUCHSIG</b> Haemostatic forceps	247
<b>FULLER</b> Introducing forceps for teflon prothesis	742
Furuncle knife	735
<b>G</b>	
Galea hooks	545
Gall bladder scoop	873
Gall bladder trocar	71
Gall duct dilators	872
Gall stone forceps	877, 878
Gall stone probes	872, 873
Gall stone scoopes	873, 874
<b>GALLAHER</b> Nasal rasps	1085
<b>GARDNER</b> Bone cutting forceps	1141

GARRETT Vascular dilators	809	GUTHRIE Retractors	432
GAST Tongue depressors	615	GUYON Catheter guide	947
GAUSS Scalp flap forceps	936	GUYON Dilating bougies	949
GELFOAM Septum forceps	701	GUYON Kidney pedicle clamps	282-284
GELLHORN Cervical biopsy and specimen forceps	919	GWYNE-EVANS Tonsil dissectors	623
GELPI Retractors	485	Gynaecological scissors	98-102
GELPI-LOKTITE Wound spreaders, self retaining	456, 457	Gynaecological TC scissors	162
GELPI-SEILETZ Wound spreaders, self retaining	457	<b>H</b>	
GEMINI Dissecting and ligature forceps	265	HABERER Abdominal and intestinal spatulas	421
GERALD Dissecting forceps	202	HACKSTOCK Wire forceps	1161
GERALD Dissecting TC forceps	233	Haemostatic forceps	238-260
GERALD Ear and nasal dressing forceps	222	HAGLUND-STILLE Plaster spreaders	1193
GERALD Tissue forceps	214	HAIGHT Rib Spreader	781
GERALD Tissue TC forceps	235	HAJEK Mallets	1013
GERALD-BROWN Tissue forceps	216	HAJEK Nasal forceps	991
GERSTER Traction bar for bone clamps	1126	HAJEK Suction tubes	87
GERZOG Mallets	1017	HAJEK-CLAUS Laminectomy punches	958
GERZOG-SEXTON Tympanum perforator	735	HAJEK-KOFLER Laminectomy punches	959
GIERTZ-STILLE Rib shears	767	HAKANSSON Bone rongeurs	1128
GIGLI T-Bar handle for wire saws	1010	HALLE Bone curettes	1098
GIGLI Wire saws	1010	HALLE Dura knives	553
GILLIES Dissecting forceps	199	HALLE Septum elevators	674
GILLIES Needle holders with scissors	495	HALSEY Needle holders	491
GILLIES Osteotomes	1026	HALSEY TC Needle holders	524
GILLIES Retractors	442	HALSTED-MOSQUITO Haemostatic forceps	244, 250, 256, 258, 259
GILLIES TC Needle holders	528	Hand drills	1171-1173
GILLIES Tissue forceps	211	Hand restrainer	1182
GILLIES Tissue TC forceps	234	HARDY Curette	707
GILLIES-MINI TC Needle holders	528	HARDY Enucleators	705
GILL-VERNET Retractors	438	HARDY Implant fork	705
GLASSMANN Non-traumatic tissue forceps	218	HARDY-FAHLBUSCH Dissectors	703
GLOVER Atraumatic vascular clamps	303, 315, 316	HARGIS Anterior border stripper	1057
GLOVER Bulldog clamps	290, 296	HARGIS Mandibular body retractor	1057
GLUCK Rib shears	764	HARKEN Atraumatic vascular clamps	334
Goitre grasping forceps	657	HARKEN Vena cava clamps	348
Goitre probe	657	HARRINGTON Retractors	409, 485
GOLDMANN Nasal fracture elevators	698	HARRINGTON-PEMBERTON Retractors	409
GOLDMANN-FOX Gum scissors	125	HARTMANN (FRENCH) Tuning forks	713
GOLDMANN-FOX Gum TC scissors	177	HARTMANN Bone rongeurs	1129
GOELET Retractors	418	HARTMANN Cotton applicators	633
GOMEL Micro scissors	143	HARTMANN Ear catheters	716
GOOD Tonsil scissors	117	HARTMANN Ear forceps	732, 733
GOOD-SCHWEKENDIECK Tonsil scissors	117	HARTMANN Ear hooks	731
GORNEY Dissecting scissors	113	HARTMANN Ear polypus forceps	732
GORNEY Face-lift TC scissors	175	HARTMANN Ear speculas	721-723
GORNEY-FREEMAN Face-lift TC scissors	176	HARTMANN Haemostatic forceps	250
GOSSET Abdominal retractors	469	HARTMANN Intestinal forceps	846
GOSSET-BABY Abdominal retractors	469	HARTMANN Nasal forceps	992
Gouges	751, 1025-1051	HARTMANN Nasal speculas	661, 662
GOURDET Uterine curettes	924	HARTMANN Tampon and polypus forceps	669, 670
GRAEFE Delicate surgical scissors	129	HARTMANN Tongue depressors	601
GRAEFE Dissecting knives	51	HARTMANN Tuning forks	713-715
GRAEFE Iris forceps	197, 208	HARTMANN-HALLE Nasal speculas	661
GRAEFE Retractors	429, 431	HARTMANN-HOFFMANN Ear forceps	733
GRAEFE Skin grasping forceps	686	HARTMANN-NOYES Ear forceps	733
GRAEFE Tissue grasping forceps	209	HARTMANN-WEINGAERTNER Ear forceps	733
GRAHAM Dura hooks	554	HARTMANN-WULLSTEIN Ear forceps	732
GRAVE Vaginal speculas	883, 884, 886, 887	HARVEY Wire cutting scissors	148
GRAY Dissecting and ligature forceps	280	HARVEY-JACKSON Wound spreaders, self retaining	463
GREEN-ARMYTAGE Caesarean section haemostatic forceps	936	HASLINGER Velum retractor	627
GREGORY Atraumatic vascular clamps	326	HASOBUCCHI fork	706
GREGORY Face-lift SCT scissors	190	HATFIELD Bone curettes	1112, 1113
GREGORY Face-lift TC scissors	175	HAYES Sigmoid anastomosis forceps	857
GREGORY-SOFT Bulldog clamps	297	Head band	35
GREVEN Micro wire bending forceps	741	Head lamps	26-27
GREY-TURNER Haemostatic forceps	256	HEANEY Hysterectomy Forceps	274
GRONINGEN Dura hooks	554	HEANEY Needle holders	492
GROSS Dressing forceps	350, 351	HEANEY TC Needle holders	526
GROSS Ear loops	730	HEANEY-RAZAK Hysterectomy Forceps	274
GROSS-MAIER Dressing forceps	349, 350	HEANLEY Bone rongeurs	1127
GRUBER Ear speculas	725	HEART-GATE Atrial blade introducer	820
GRUENWALD Atomizers	761	HEART-GATE Atrial blades	820
GRUENWALD Septum forceps	757	HEART-GATE Atrial blades holders	820
GRUENWALD-HENKE Nasal forceps	991	HEART-GATE Atrial Retractor	792, 793
GRUENWALD-JANSEN Ear and nasal dressing forceps	222	HEART-GATE Cardioplegia needle	823
Guide needles	66-68	HEART-GATE Instruments for minimally invasive surgery	818-823
GUILLEN Suction elevators	678	HEART-GATE Ligature catcher	822
GUILFORD-WRIGHT Wire cutting scissors	148	HEART-GATE Ligature ruler	823
GULEKE Bone rongeurs	1131	HEART-GATE Magnet bar	822
Gum scissors	124, 125	HEART-GATE Nerve and vessel hooks	822
Gum TC scissors	177, 178	HEART-GATE Rib Spreader	791, 792
GUNAR-HEY Tubing clamps	371	HEART-GATE Scalpel handle	823
GUSTELLA Osteotomes	684	HEATH Ligature scissors	147





HEATH Mallets	1015
HEGAR Needle holders	488
HEGAR TC Needle holders	521
HEGAR Uterine dilators	897, 898
HEGAR-BAUMGARTNER Needle holders	490
HEGAR-BAUMGARTNER TC Needle holders	524
HEGAR-VASCULAR TC Needle holders	532
HEGEMANN-DIETRICH Vascular scissors	137, 158
HEGEMANN-DIETRICH Vascular SCT scissors	191
HEGEMANN-DIETRICH Vascular TC scissors	180
HEGENBARTH Clip applying forceps	517
HEIFETZ Brain spatulas	543
HEIMING Nephrostomy forceps	874
HEISS Haemostatic forceps	244, 256
HEISTER Mouth gags	603
HELFFERICH-BIER Amputation and resection saws	1009
HEMINGWAY Bone curettes	1093
Hemorrhoidal ligators	866-868
HENDERSON Wound spreaders, self retaining	449
HENKE Tonsil dissectors	622
HENLEY Atraumatic vascular clamps	331
HENLEY Wound spreaders, self retaining	450, 451
HENNIG Plaster spreaders	1193
Heparin flushing needles	73
HEPP-SCHIEDL Micro scissors	143
HERBERHOLD Tongue depressors	616
HERMANN Chisels	751
HERMANN Gouge	751
HERMANN Mallet	751
HERRICK Kidney pedicle clamps	283
HERTZLER Rib Spreader	780
HERZ Meniscus and cartilage grasping forceps	1145
HERZ Tendon passing forceps	1150
HESS Bulldog clamps	292
HEY-GROVES Bone holding forceps	1123
HEYMANN Nasal scissors	120, 156
HEYMANN Nasal SCT scissors	190
HEYMANN Septum forceps	696
HEYMANN-KNIGHT Tampon and polypus forceps	670
HEYWOOD-SMITH Polypus and ovum forceps	357
HIBBS Chisels	1038
HIBBS Gouges	1039
HIBBS Osteotomes	1038
HIRSCHMANN Anuscopes	863
HOEN Dura-Dissectors	551
HOEN Laminectomy forceps	1007
HOEN Raspatories	1068
HOEN V. EICKEN Ligature catcher	627
HOESEL Retractors	408
HOESEL TC Needle holders	530
HOFF Towel clamps	369
HOHMANN Bone levers	1077-1079
HOKE Osteotomes	1037
Holding frame for mouth gags	617
HOLINGER Operating laryngoscopes	641
Holloware	1212-1217
HOLSHER Nerve root retractors	553
HOLZBACH Abdominal retractors	475
HOLZBACH Haemostatic forceps	258
HOLZHEIMER Wound spreaders, self retaining	445
Hooks	706, 708, 747, 748, 750, 752, 753, 831, 832, 841
HOPKINS Plaster knives	1195
HORSLEY Nerve root retractors	552
HOUSE Micro needle	748
HOUSE Raspatory	747
HOUSE Sharp curettes	751
HOUSE Suction tubes	86
HOUSE Tracheal retractor	656
HOUSE-DIETER Malleus Punches	742
HOWARTH Septum elevators	678
HUBER Universal Handle	636, 923
HUDSON Hand drills	1172
HUGHES Stirrup hook	747
HUMBY Dermatome	59
HUNTER Splinter forceps	225
HURD Cleft palate needles	626
HURD Tonsil dissectors	622
HUSFELDT Atraumatic vascular clamps	327
Hysterectomy Forceps	271-276, 286
<b>I</b>	
I.M.A. Mammaria Spreader	794-797
Implant fork	705
INGE Lamina spreaders	592

Injection needle	72
Instrument boxes	1216, 1217
Instrument care lubricant	1227
Instrument for removal of I.U.D.	911
Instrument trays	1215, 1216
Instruments for beating heart surgery	824
Instruments for minimally invasive surgery	818-823
Insufflation cannula	73
Intestinal and tissue grasping forceps	360-366
Interdental osteotomes	1036
Interosseous knife	53
Intestinal and stomach forceps	860
Intestinal forceps	844-854
Intima spatula	813, 814
Introducing forceps for teflon prothesis	742
Intubation tube	653
<b>IOWA</b> Injection needle	72
<b>IOWA</b> Uterine tenaculum forceps	905
<b>IRIS</b> Delicate surgical scissors	127-129, 157
<b>IRIS</b> Delicate surgical SCT scissors	191
<b>IRIS</b> Delicate surgical TC scissors	178
Iris forceps	197, 208
Irrigators	1215
<b>IRWIN</b> Wound spreaders, self retaining	456
<b>ISRAEL</b> Retractors	380
<b>ITERSON</b> Tracheal retractor	655
<b>IVES-FANSLER</b> Anuscopes	863
<b>J</b>	
<b>JABALEY</b> Delicate surgical scissors	130, 157
<b>JACKSON</b> Tendon passing forceps	1150
<b>JACKSON</b> Tracheal retractor	656
<b>JACKSON</b> Vaginal speculas	893
<b>JACKSON-BURROWS</b> Wound spreaders, self retaining	457
<b>JACOBS</b> Uterine tenaculum forceps	906
<b>JACOBSON</b> Bone curettes	1091
<b>JACOBSON</b> Buttoned probe	827, 828
<b>JACOBSON</b> Ligature pusher	827, 828
<b>JACOBSON</b> Twin probe	827
<b>JACOBSON</b> Vessel knife	827, 838
<b>JAEGER</b> Meniscus and cartilage grasping forceps	1145
<b>JAEGER</b> Tendon passing forceps	1151
<b>JAMESON</b> Caliper	22
<b>JAMESON</b> Dissecting scissors	114, 155
<b>JAMESON</b> Needle holders	492
<b>JAMESON</b> SCT Dissecting scissors	189
<b>JAMESON</b> TC Dissecting scissors	172
<b>JANET</b> Syringes	75, 76
<b>JANSEN</b> Bone curettes	1091, 1092
<b>JANSEN</b> Bone rongeurs	1129, 1130
<b>JANSEN</b> Ear and nasal dressing forceps	222
<b>JANSEN</b> Ear curettes	730
<b>JANSEN</b> Head lamps	27
<b>JANSEN</b> Raspatories	1060, 1064
<b>JANSEN</b> Wound spreaders, self retaining	446
Jars	1213
<b>JATHO</b> Naso-pharyngeal forceps	631
<b>JAVID</b> Atraumatic vascular clamps	326, 327
<b>JENNINGS</b> Mouth gags	605
Jeweler forceps	228
<b>JIKEI</b> Septum forceps	759, 760
<b>JOBSON-HORNE</b> Cotton applicators	65
<b>JOHN-HOPKINS</b> Applying forceps for bulldog clamps	293
<b>JOHN-HOPKINS</b> Bulldog clamps	292, 293
<b>JOHNS-HOPKINS</b> Dissecting and ligature forceps	281
<b>JONES</b> Towel clamps	369
<b>JORGENSON</b> Vascular scissors	132
<b>JOSEPH</b> Delicate surgical scissors	123
<b>JOSEPH</b> Delicate surgical SCT scissors	190
<b>JOSEPH</b> Delicate surgical TC scissors	177
<b>JOSEPH</b> Nasal rasps	1084
<b>JOSEPH</b> Nasal saws	685
<b>JOSEPH</b> Raspatories	1053
<b>JOSEPH</b> Retractors	443
<b>JOSEPH</b> Rhinoplastic knives	672, 673
<b>JOSEPH</b> Septum elevators	677
<b>JOSEPH</b> Septum knife	673
<b>JOSEPH</b> TC Dissecting scissors	172
<b>JOSEPH-MASING</b> Septum elevators	677
<b>JUDD-ALLIS</b> Intestinal and tissue grasping forceps	365
<b>JUDD-MASSON</b> Bladder retractors	952
<b>JUERS</b> Micro wire bending forceps	742
<b>JURASZ</b> Laryngeal polypus forceps	634
<b>JURASZ</b> Naso-pharyngeal forceps	631

<b>K</b>			
KABIERSKE Powder blowers	718	KOELNER Scalp haemostatic clips	546
KADER Retractors	425	KOENIG Elevators	1052
KAHN Face-lift scissors	117	KOENIG Ligature conductors	512
KALLMORGEN Vaginal speculas	891	KOENIG Raspatories	1053
KALT Needle holders	497	KOENIG Retractors	437
KANE Umbilical cord clamp	937	KOENIG Tuning forks	714
KANTROWITZ Dissecting and ligature forceps	266	KOERTE Retractors	379, 424
KARLIN-CRANK Laminectomy retractors	588	KOGAN Endospeculas	896
KATSCH Comedone extractor	61	KONRICH Sterilization drums	1224
KATZIN Micro scissors	142	KOOS Vessel knife	838
KATZIN-BARRAQUER Micro scissors	142	KRAEMER Raspatories	1063
KAYE Face-lift scissors	118	KRAEMER Retractors	388
KAYE Face-lift TC scissors	175	KRAUS Vessel knife	838
KAYE-MILLARD Retractors	444	KRAUSE Antrum trocar	71
KELLY Delicate surgical scissors	123, 156	KRAUSE Broncho-Oesophagoscopy forceps	637
KELLY Delicate surgical SCT scissors	190	KRAUSE Ear polypus snares	738
KELLY Delicate surgical TC scissors	177	KRAUSE Polypus snares	671
KELLY Dissecting and ligature forceps	270	KRAUSE-VOSS Ear polypus snares	738
KELLY Haemostatic forceps	249	KRAUSE-VOSS Polypus snares	671
KELLY Polypus and ovum forceps	356	KRAYENBUEHL Nerve and vessel hooks	829
KELLY Retractors	406, 412, 413, 485	KRESSNER Septum forceps	699
KELLY Sphincteroscopes	863	KRISTELLER Vaginal speculas	889-890
KELLY-RANKIN Haemostatic forceps	247	KRISTELLER WIENER Vaginal speculas	891
KELMAN-MC PHERSON Micro forceps	227	KROENLEIN Haemostatic forceps	251
KERN-LANE Bone holding forceps	1119, 1121	KRONECKER Ligature needles	502
KERPEL Bone curettes	1114	KUEHNE Cover glass forceps	226
KERRISON Laminectomy punches	958, 976, 977	KUEMMEL Retractors	401, 424
KERSTING Sigmoid anastomosis forceps	858	KUESTNER Uterine tenaculum forceps	904
KEVORKIAN Biopsy curettes	912	<b>L</b>	
KEVORKIAN Cervical biopsy and specimen forceps	920, 922	LA FORCE Adenotomes	630
KEVORKIAN-PACIFIC Cervical biopsy and specimen forceps	921	LA GRANGE Gum scissors	124
KEY Raspatories	1068	LABORDE Tracheal dilators	654
KEYES Dermal punch	60	Lachrymal probes	62, 63
Kidney Dishes	1212	LACK Tongue depressors	601
Kidney pedicle clamps	282-284	LAHEY Dissecting and ligature forceps	280, 281
Kidney stone forceps	875	LAHEY Goitre grasping forceps	657
KIELLAND Obstetrical forceps	933	LAHEY Retractors	438
KILLIAN Cotton applicators	633	LAHEY Uterine tenaculum forceps	908
KILLIAN Elevators	1055	LAMBERT-KAY Atraumatic vascular clamps	330
KILLIAN Nasal speculas	663-666	LAMBOTTE Bone holding forceps	1124, 1125
KILLIAN Raspatories	1055	LAMBOTTE Osteotomes	1034
KILLIAN Septum elevators	678	LAMBOTTE Raspatories	1065
KILLIAN Septum gouges	679	LAMBOTTE Retractors	378
KILLIAN Septum scissors	700	Lamina spreaders	592, 593
KILLIAN Tampon and polypus forceps	670	Laminectomy punches	958-978, 984, 985
KILLIAN-CLAUS Septum gouges	679	Laminectomy punches, detachable	962, 966
KILLIAN-RUDERT Nasal speculas	665	Laminectomy retractors	556-559, 564-567, 586-591
KILNER (RAGNELL) Dissecting scissors	113, 155	Laminectomy rongeurs	979-983, 985-987, 994-1007
KILNER Alar nasal hooklets	688	Lancet knives	747, 752, 837
KILNER Delicate surgical scissors	126	LANDAU Trocars	71
KILNER Needle holders	491	LANDAU Vaginal speculas	893
KILNER Retractors	419, 439, 442	LANDOLT Curette	706
KILNER TC Dissecting scissors	172	LANDOLT Eucleators	706
KILNER TC Needle holders	525	LANDOLT Hook	706
KILNER-DOUGHTY Mouth gags	613	LANDOLT Laminectomy rongeurs	1005
KIRK Mallets	1017	LANDOLT Nasal scissors	121
KIRKLIN Retractors	438	LANDOLT Raspatories	562
KIRSCH Retractors	388	LANDOLT Scalpel handles	826
KIRSCHNER Abdominal retractors	472, 473	LANDOLT Spreading forceps for speculas	702
KIRSCHNER Ligature conductors	510, 511	LANDOLT-REULEN Curette	708
KIRSCHNER Wire traction bows	1154, 1155	LANDOLT-REULEN Dissectors	708
KLAPP Retractors	433	LANDOLT-REULEN Raspatory	708
KLEINERT-KUTZ Bone rongeurs	1127, 1132	LONDON Vaginal speculas	892
KLEINERT-KUTZ Retractors	444	LANE Bone levers	1076
KLEINERT-KUTZ Tendon passing forceps	1152	LANE Intestinal forceps	853
KLEINSCHMIDT Intestinal forceps	852	LANE Tissue forceps	215
KLIMA-ROSEGGER Sternum puncture needle	73	LANE Towel clamps	368
KLINKENBERGH-LOTH Vascular scissors	131	LANE-TRETHOWAN Bone levers	1076
KNAPP Retractors	432	LANGE Bandage scissors	1186
Knee retractors	1148, 1149	LANGE Broncho-Oesophagoscopy forceps	637
KNIGHT Nasal scissors	121	LANGE Retractors	436
KNIGHT Septum forceps	696	LANGE-HOHMANN Bone levers	1079, 1080
KNIGHTON Lamina spreaders	593	LANGENBECK Amputating knives	52
KNOWLES Bandage scissors	1186	LANGENBECK Amputation and resection saws	1010
KOCHER Bladder spatulas	953	LANGENBECK Bone holding forceps	1118
KOCHER Goitre probe	657	LANGENBECK Ear loops	728
KOCHER Haemostatic forceps	254, 255	LANGENBECK Elevators	1074
KOCHER Intestinal forceps	846, 848	LANGENBECK Finger protector	619
KOCHER Ligature needles	502	LANGENBECK Raspatories	1064
KOCHER Retractors	376, 392, 399, 404	LANGENBECK Resection knives	53
KOCHER-LANGENBECK Retractors	389, 390	LANGENBECK Retractors	381-383
KOCHER-WAGNER Retractors	405	LANGENBECK TC Needle holders	531
		LANGENBECK-RYDER TC Needle holders	534



LANGE-WILDE Ear polypus snares	738	LOUTE Cerclage instruments	1158
LANGE-WILDE Polypus snares	671	LOVE Nerve root retractors	551, 552, 553
LANG-STEVENSON Intestinal forceps	852	LOVE Velum retractor	627
Laryngeal mirrors	632	LOVE-GRUENWALD Laminectomy rongeurs	996
Laryngeal polypus forceps	634, 635	LOVELACE Lung grasping forceps	801
Laryngeal snare	652	LOWER Dissecting and ligature forceps	281
Laryngeal Syringe	76	LOWMAN Bone clamps	1126
Laryngology	652, 653	LOWMAN-HOGLUND Bone clamps	1126
Laryngoscopes and accessories	36-43	LUBET-BARBON Tampon and polypus forceps	669
Laryngoscopes battery handle	42-43	LUC Septum forceps	697
Laryngoscopes with cold light and accessories	40-41, 43	LUCAE Ear and nasal dressing forceps	221, 222
LAWRENCE Dissecting and ligature forceps	264	LUCAE Mallets	1016
Lead hands	1182	LUCAE Retractors	429
LEBSCHKE Conductors for wire saws	549	LUCAE Tuning forks	713, 714
LEBSCHKE Sternum chisel	764	LUCAE Tympanum perforators	737
LEES Atraumatic vascular clamps	314, 323	LUCAS Bone curettes	1091
LEGUEU Bladder retractors	952	LUER Bone rongeurs	1128, 1130
LEGUEU Bladder spatulas	953	LUER Intestinal and tissue grasping forceps	366
LEKSELL Bone rongeurs	1137	LUER Retractors	419
LEKSELL-STILLE Bone rongeurs	1137	LUER Syringes	74
LELAND-JONES Atraumatic vascular clamps	317-319	LUER Trachea tubes	654
LEMPERT Bone curettes	1098	LUER-FRIEDMANN Bone rongeurs	1127
LEMPERT Elevators	737	LUER-KOERTE Gall stone scoopes	873
LEMPERT Raspatories	1054	LUER-LOCK Syringes	74, 76
LEMPERT Suction tubes	80	LUER-STILLE Bone rongeurs	1138, 1139
LERCHE Tissue forceps	218	LUKART-BILL Traction handel	936
LERICHE Haemostatic forceps	247, 257	LUKENS Tracheal retractor	656
LERICHE Retractors	423	Lung grasping forceps	216, 801
LEWIN Reposition forceps	1116	Lung spatulas	800, 801
LEWIS Nasal rasps	1084	LUNIATSCHEK Tampon plugger	626
LEWKOWITZ Stone forceps	945	Lupus curettes	60
LEXER Chisels	1042	Lupus scraper	60
LEXER Dissecting scissors	112, 155	LURZ Gall stone forceps	877
LEXER Gouges	1043, 1044, 1048	Luxation lever	1083
LEXER Osteotomes	1043, 1047	<b>M</b>	
LEXER SCT Dissecting scissors	188	M.G. HOSPITAL Needle holders	489
LEXER Spongiosa gouges	1045, 1048	MAGILL Catheter introducing forceps	944
LEXER TC Dissecting scissors	171	MAGILL Suction tubes	79
LEXER-BABY Dissecting scissors	112	Magnet bar	822
LEXER-MINI Gouges	1041	Magnifying glasses	23
LEXER-MINI Osteotomes	1041	MAINGOTT Hysterectomy Forceps	275
LEYLA Self-Retaining retractors for skull mounting	540-542	Malleolar forceps	1117
LICHTENBERG Needle holders	497	Mallets	751, 1013-1020
LICHTENBERG TC Needle holders	530	Malleus Punches	742, 744
LICHTWITZ Antrum trocar	70, 87	MALTZ Nasal rasps	1085, 1087
Ligature adjuster	513	Mammoplasty retractors	422
Ligature catchers	513, 627, 815, 822	Mammaria Spreader	794-797
Ligature conductors	509-513	Mandibular body retractor	1057
Ligature guide	829	MANNERFELT Gouges	1181
Ligature instrument	627	MANNERFELT Osteotomes	1181
Ligature needles	500-509, 626	MANNERFELT Raspatories	1180, 1181
Ligature pusher	827, 828	MANNERFELT Retractors	1178-1180
Ligature rings	866	MARKWALDER Bone rongeurs	1139
Ligature ruler	823	MARQUARDT Bone rongeurs	1133
Ligature scissors	146, 147	MARSCHIK Tonsil grasping forceps	620
Lip and cheek retractors	618	MARSCHIK-KRONE Tonsil grasping forceps	621
LISTER Bandage and plaster-of-paris scissors	1190	MARTIN Cartilage scissors	116
LISTER Bandage scissors	1187	MARTIN Cotton applicators	65
LISTER Dilating bougies	950	MARTIN Dressing forceps	351
LISTER Sinus forceps	352	MARTIN Finger ring saws	1011
LISTON Amputating knives	52	MARTIN Meniscus and cartilage grasping forceps	1146
LISTON Bone cutting forceps	1141-1143	MARTIN Pelvimeter	931
LISTON-KEY Bone cutting forceps	1144	MARTIN Plaster knives	1195
LISTON-STILLE Bone cutting forceps	1143	MARTIN Retractors	375, 377, 414
LITTAUER Cilia forceps	223	MARTIN Uterine probes	899
LITTAUER Ear polypus forceps	732	MARTIN Waste forceps	1218
LITTAUER Ligature scissors	147	MARTIN-CUSHING Raspatories	1071
LITTAUER Tampon and polypus forceps	670	MARTINI Bone curettes	1091
LITTLE Retractors	438	MARTIN-LANGENBECK Raspatories	1071
LITTLER Delicate surgical scissors	126	MASING Cartilage slitting knife	672
LITTLER Ligature scissors	147	MASING Ear forceps	734
LITTLEWOOD Intestinal and tissue grasping forceps	365	MASING Nasal retractors	690
Liver blind puncture needles	74	MASING Septum elevators	677
LLOYD-DAVIES Rectal scissors	106	MASSON Needle holders	493
LLOYD-DAVIES Sigmoid anastomosis forceps	856	MASSON TC Needle holders	527
LOCKHART-MUMMERY Probes	64	MASSON-LUETHY Needle holders	494
LOCKLIN Gum TC scissors	178	MASTIN Muscular clamp	657
LOCKLIN Vascular scissors	133	MATHIEU Foreign Body Forceps	948
LOCKWOOD Intestinal and tissue grasping forceps	362	MATHIEU Needle holders	496
LOCKWOOD-ALLIS Intestinal and tissue grasping forceps	365	MATHIEU Rectal retractors	861
LOPEZ-REINKE Tonsil dissectors	622	MATHIEU Retractors	418
LORENZ Bandage and plaster-of-paris scissors	1190	MATHIEU TC Needle holders	528, 529
LORNA (EDNA) Towel clamps	369	MATHIEU Vaginal speculas	892

MATHIEU-RYDER TC Needle holders	534	Micro ear scissors	740, 744
MATZENAUER Vaginal speculas	892	Micro forceps	226-228
MAUNDER Oral screw	619	Micro grasping forceps	642-643, 646, 649-651
MAXIMUS Blood pressure manometers	24	Micro hooks	749
MAYFIELD Bone rongeurs	1132	Micro instruments	745-753, 827-841
MAYO Gall stone scoopes	874	Micro knives	745
MAYO Safety pins	372	Micro lumbar discectomy retractor Set	583
MAYO Surgical scissors	103, 152	Micro needle holder	643, 644
MAYO Surgical SCT scissors	186	Micro needles	748, 749, 752, 753
MAYO Surgical TC scissors	165	Micro scissors	138-143, 644, 646, 651
MAYO TC Ligature scissors	181	Micro wire bending forceps	741, 742, 744
MAYO Tongue spatulas	600	MICRO-ADSON Haemostatic forceps	245
MAYO-ADAMS Wound spreaders, self retaining	449	MICRO-MOSQUITO Haemostatic forceps	250, 259
MAYO-BLAKE Gall stone forceps	877	MICRO-RYDER TC Needle holders	532
MAYO-GUYON Kidney pedicle clamps	285	MICRO-VASCULAR TC Needle holders	532
MAYO-HARRINGTON Surgical scissors	105, 153	MIDDELDORPF Retractors	400
MAYO-HARRINGTON Surgical SCT scissors	186	MIDDLETON-JANSEN Septum forceps	699
MAYO-HARRINGTON Surgical TC scissors	165	MIKULICZ Peritoneum forceps	277-279
MAYO-HEGAR Needle holders	488, 489	MIKULICZ Retractors	392, 393
MAYO-HEGAR TC Needle holders	521	MILAN Biopsy curettes	914
MAYO-LEXER TC Dissecting scissors	171	MILIGAN Wound spreaders, self retaining	449
MAYO-NOBLE Surgical scissors	105	MILLARD (COTTLE) Finger-ring hooks	689
MAYO-ROBSON Intestinal forceps	850	MILLER Bone curettes	1092
MAYO-RUSSIAN Tissue grasping forceps	203	MILLER Laryngoscopes	37
MAYO-STILLE Surgical scissors	104, 153	MILLER Laryngoscopes with cold light	41
MAYO-STILLE Surgical SCT scissors	187	MILLER Nasal rasps	1087
MAYO-STILLE Surgical TC scissors	167	MILLER-COLBURN Bone curettes	1094
MC CLINTOCK Placenta and ovum forceps	940	MILLER-COLBURN Nasal rasps	1088
MC CLURE Micro scissors	138	MILLIGAN Dura-Dissectors	550
MC CULLOCH Laminectomy retractors	586, 587	MILLIN Bladder neck spreader	953
MC DONALD Raspatories	1055	MILLIN Bladder retractors	952
MC GEE Hook	750	MILLIN Capsule forceps	955
MC GEE Micro wire bending forceps	741, 744	MILLS Vascular scissors	137
MC GIVNEY Hemorrhoidal ligators	868	MINI-HOHMANN Bone levers	1075
MC GLAMRY Raspatories	1068	MINI-LAMBOTTE Osteotomes	1030, 1031
MC INDOE Cartilage scissors	115	MINI-LANGENBECK Retractors	439
MC INDOE Dissecting forceps	199	MINIMUS Blood pressure manometers	24
MC INDOE Dissecting TC forceps	232	MINI-OLSEN Needle holders with scissors	495
MC INDOE Osteotomes	684	MINI-ROUX Retractors	417
MC INDOE Retractors	443	MINI-TOWNSEND Cervical biopsy and specimen forceps	922
MC INDOE Tissue forceps	211	Mini-transformer	27
MC INTOSH Laryngoscopes	38	MINI-VANNAS Micro scissors	138
MC INTOSH Laryngoscopes with cold light	40	MISKIOM Wound spreaders, self retaining	454
MC IVOR Mouth gags	614	MIXTER Dissecting and ligature forceps	268, 280
MC IVOR Tongue depressors	616	MIXTER Gall stone forceps	878
MC KENTY Septum elevators	676, 677	MIXTER Surgical scissors	97
MC KENZIE Clip applying forceps	547	MIXTER-O'SHAUGNESSY Dissecting and ligature forceps	281
MC KENZIE Silver brain clips	546	MOCK Heparin flushing needles	73
MC KENZIE Silver clip carrier	546	MOELTGEN Flexometer	20
MC KESSON Oral screw	619	MOLDENHAUER Ear lever	730
MC QUIGG-MIXTER Atraumatic vascular clamps	300	MOLDESTAD Retractors	433
MEAD Bone rongeurs	1130	MOLLISON Wound spreaders, self retaining	447
MEAD Mallets	1013	MOLT Mouth gags	603
Measuring cup	1213	MOLT Raspatories	1054
Measuring rod	748	MOORE Gall bladder scoop	873
Measuring tape	21	MOORE Hand drills	1171
Meatotomy	948	MOORFIELD Suture forceps	198
Medicine cup	1213, 1214	MORGAN Proctoscopes	864
Medicine spoon	1213	MORITZ-SCHMIDT Tongue depressors	601
MEEKER Dissecting and ligature forceps	266	MORRIS Retractors	401
MEMORY Brain spatulas	544	MORRIS-DE BAKEY Atraumatic vascular clamps	324
MENGHINI Liver blind puncture needles	74	MORSE Rib Spreader	775, 778, 779
Meniscus and cartilage grasping forceps	1145, 1146	MORSE-FAVALORO Rib Spreader	778
Meniscus knives	1146, 1147	MOSHER-BRUENINGS Intubation tube	653
MERCEDES Rib Spreader	790	MOSQUITO-DANDY Haemostatic forceps	248
Metal Catheters	951	Mouth gags	603-614
METZENBAUM Dissecting scissors	108-111, 154	MOYNIHAN Gall stone probes	872
METZENBAUM Needle holders	489	MOYNIHAN Hysterectomy Forceps	273
METZENBAUM SCT Dissecting scissors	187, 188	MUCK Periosteal Knives	735
METZENBAUM TC Dissecting scissors	167-170	Mucosa knives	673, 745
METZENBAUM TC Ligature scissors	181	MUEHLING Raspatories	562
METZENBAUM-BABY Dissecting scissors	111, 155	MUELLER Sigmoid anastomosis forceps	858
METZENBAUM-LAHEY TC Dissecting scissors	173	MUELLER Wound spreaders, self retaining	445
MEYER Reposition forceps	1116	MUENCHEN Biopsy curettes	913
MEYERDING Retractors	407, 441, 486	MURPHY Head band	35
MEYERDING Wound spreaders, self retaining	452	MURPHY-LANE Luxation lever	1083
MICHEL Clip applying forceps	517	Muscular clamp	657
MICHEL Rhinoscopic mirrors	632	MUSEUX Uterine tenaculum forceps	905, 906, 908
MICHEL Suture Clips	516	MUSGROVE Cerumen pick and woolcarrier	730
MICK Bandage and plaster scissors	1188, 1189	MYLES Nasal forceps	990
Micro cup-shaped forceps	642, 647-651, 739, 743	Myoma knife	56
Micro dissectors	814	Myoma screws	908
Micro ear forceps	739, 743	Myringotome	735





Myrtle leaf probes	62	OLIVECRONA Bone rongeurs	1131
<b>N</b>		OLIVECRONA Brain spatulas	544
<b>NABATOFF</b> Varicose vein probe Set	806	OLIVECRONA Dura-Dissectors	550
<b>NAEGELE</b> Obstetrical forceps	932	OLIVECRONA Nasal scissors	120
<b>NAGER</b> Velum retractor	627	OLIVECRONA Trigeminal knives	57
Nail files	1206	OLIVECRONA Wire saws	1010
Nail nippers	1205, 1206	OLIVECRONA-TOENNIS Clip applying forceps	547
Nail scissors	1204	OLLIER Retractors	380
Nailbrush	1227	OLSEN-HEGAR Needle holders with scissors	495
Nasal forceps	988-994	OLSEN-HEGAR TC Needle holders	527
Nasal fracture elevators	698	OMBREDANNE Mallets	1015
Nasal rasps	1084-1090	OMS retractors	1057
Nasal retractors	687-690	Operating laryngoscopes	638-641
Nasal saws	685	Oral screws	619
Nasal scissors	118-122, 156, 754	Organ grasping forceps	358
Nasal SCT scissors	189, 190	Oscillating electric autopsy saws	1022, 1023
Nasal speculas	660-668	Oscillating electric plaster saws	1196-1199
Nasal TC scissors	174	<b>O'SHAUGNESSY</b> Dissecting and ligature forceps	281
Naso-pharyngeal forceps	631	Osteotomes	680-684, 1021, 1026-1051
Needles	841	<b>O'SULLIVAN - O'CONNOR</b> Vaginal speculas	895
Needle cases	1222, 1223	<b>O'SULLIVAN-O'CONNOR</b> Abdominal retractors	476
Needle holders	488-499	OTIS Urethrotome	954
Needle holders with scissors	495	Otoscopes	599, 712
Needle holders with tungsten carbide inserts	520-535	<b>OVERHOLT</b> Dissecting and ligature forceps	261, 262
<b>NEFF</b> Meniscus knives	1146	<b>OVERHOLT-GEISSENDOERFER</b> Dissecting and ligature forceps	260
<b>NEGUS (GUEDEL)</b> Laryngoscopes	36	<b>OVERHOLT-MIXTER</b> Dissecting and ligature forceps	268
<b>NEGUS</b> Adenoid curettes	629	<b>P</b>	
<b>NEGUS</b> Chest support for all moth gags	617	<b>PACHON</b> Blood pressure manometers	24
<b>NEGUS</b> Kidney pedicle clamps	282	<b>PAPAVERO-CASPAR</b> Specula for hypophysectomy	702
<b>NEIVERT</b> Alar nasal hooklets	690	<b>PARKER</b> Retractors	417
<b>NEIVERT</b> Needle holders	491	<b>PARKER-BABY</b> Retractors	417
<b>NEIVERT-ANDERSON</b> Osteotomes	683	<b>PARKER-KERR</b> Sigmoid anastomosis forceps	855
<b>NEIVERT-MASING</b> TC Needle holders	524	<b>PARKER-LANGENBECK</b> Retractors	418
<b>NÉLATON</b> Directors	63	<b>PARKER-MOTT</b> Retractors	418
<b>NELSON</b> Lung grasping forceps	216	<b>PARKS</b> Nasal rasps	1087
<b>NELSON</b> Trocars	69	<b>PARTSCH</b> Chisels	1027
Neonatal vascular clamps	298-299	<b>PARTSCH</b> Gouges	1028
Nephrostomy forceps	874, 876	<b>PARTSCH</b> Mallets	1017
Nerve and vessel hooks	822, 829	<b>PARTSCH-LANGE</b> Raspatories	1052
Nerve root retractors	551-553	<b>PASSOW</b> Tampers	1024
<b>NEW ORLEANS</b> TC Needle holders	526	Patella forceps	1117
<b>NEWS</b> Tracheal retractor	656	<b>PAUL</b> Retractors	444
<b>NICOLA</b> Curette	704	<b>PAYR</b> Intestinal forceps	854
<b>NICOLA</b> Micro cup-shaped forceps	651	<b>PAYR</b> Ligature conductors	512
<b>NICOLA</b> Micro scissors	651	<b>PEAN</b> Haemostatic forceps	238-241
<b>NICOLA</b> Raspatory	704	<b>PECK-JOSEPH</b> Delicate surgical scissors	123
<b>NIEDERDELLMANN</b> Osteotomes	1038	<b>PEDERSON</b> Vaginal speculas	883, 884
<b>NISSSEN</b> Haemostatic forceps	243	<b>PEERS-BERTRAM</b> Towel clamps	369
Noise drum	716	<b>PEET</b> Splinter Forceps	1208
Non-traumatic tissue forceps	218-220	<b>PELKMANN</b> Dressing forceps	355
<b>NORFOLK &amp; NORWICH</b> Wound spreaders, self retaining	453	<b>PELTESON</b> Cotton applicators	633
<b>NOTO</b> Polypus and ovum forceps	357	Pelvimeter	931
<b>NOTT</b> Vaginal speculas	883	<b>PENFIELD</b> Dura dissectors	812
<b>NOVAK</b> Biopsy curettes	912	Penis clamps	946
<b>NOYES</b> Micro scissors	140	<b>PENNINGTON</b> Intestinal and tissue grasping forceps	362
<b>NUBOER</b> Suction tubes	78	<b>PENNINGTON</b> Septum elevators	676
<b>NUSSBAUM</b> Intestinal forceps	849	<b>PENNYBACKER</b> Bone rongeurs	1131
<b>O</b>		<b>PENNYBACKER</b> Laminectomy rongeurs	1004
<b>O'BRIEN</b> Delicate surgical scissors	128	<b>PENNYBAKER</b> Dura dissectors	813
Obstetric levers	936	Percussion hammers	16, 17
Obstetrical forceps	932-935	<b>PERCY</b> Amputation retractors	1008
<b>OBWEGESER</b> Blade osteotomes	1035	Perforators	748, 937
<b>OBWEGESER</b> Channel retractors	1057	Perineum scissors	101, 102, 152
<b>OBWEGESER</b> Chin retractor	383, 1057	Perineum TC scissors	162
<b>OBWEGESER</b> Elevators	1056	Periosteal knives	735
<b>OBWEGESER</b> Interdental osteotomes	1036	Periosteum knife	53
<b>OBWEGESER</b> Ligature needles	501	Peritoneum forceps	277-279
<b>OBWEGESER</b> Osteotomes	1035, 1036	<b>PERKINS</b> Wound spreaders, self retaining	448
<b>OBWEGESER</b> Ramus retractors	386	<b>PERTHES</b> Reamers	1012
<b>OBWEGESER</b> Raspatories	1058, 1059	<b>PESTALOZZA</b> Placenta and ovum scoops	942
<b>OBWEGESER</b> Rasps	1088	Petri dish	1214
<b>OBWEGESER</b> Soft tissue retractors	384, 385	<b>PETZ</b> Intestinal and stomach forceps	860
<b>OBWEGESER</b> Splitting osteotomes	1035	Phalangeal knife	52
<b>OBWEGESER</b> Third molar retractor	387	<b>PHANEUF</b> Hysterectomy Forceps	273
<b>OBWEGESER</b> Wedge osteotomes	1035	Phlebextractor	814
<b>OCHSNER</b> Atraumatic vascular clamps	331	Phlebodissector	814
<b>OCHSNER</b> Dissecting forceps	203	<b>PIERCE</b> Antrum trocar	70
<b>OCHSNER</b> Gall bladder trocar	71	<b>PIERCE</b> Septum elevators	676
<b>OCHSNER</b> Gall stone probes	873	<b>PINARD</b> Fetal stethoscopes	17
<b>OCHSNER-KOCHER</b> Haemostatic forceps	252, 253	<b>PIPER</b> Obstetrical forceps	934
<b>O'CONNOR</b> Retractors	431	<b>PITHA</b> Dressing forceps	352
<b>OKONEK-YASARGIL</b> Tumor forks	828	<b>PITHA</b> Oral screw	619
<b>OLDBERG</b> Laminectomy rongeurs	1005	Placenta and ovum forceps	939-941

Placenta and ovum scoops	942	Rectal biopsy forceps	869
Plaster knives	1195	Rectal probes	866
Plaster saws	1195	Rectal retractors	861, 864-866
Plaster spatula	66	Rectal scissors	106, 107
Plaster spreaders	1193, 1194	Rectal speculas	861, 862
Plastic surgery scissors	115	REDON Guide needles	66-68
PLESTER Antrum hook	747, 748	Reflex head mirror	35
PLESTER Excavator	747	REICHERT Epiglottis retractor	633
PLESTER Flap knife	745	REILL Reposition forceps	1116
PLESTER Hook	747	REILL Wire cutting forceps	1164
PLESTER Scraper	748	REINER Plaster knives	1195
PLESTER Sickle knife	745	Reposition forceps	1115
PLESTER Suction tubes	77	RESANO Capsula scissors	105
PLESTER Wire guide	747	RESANO Sigmoid anastomosis forceps	859
PLESTER Wound spreaders, self retaining	448	Resection knives	53, 54
POLITZER Air bags	716, 717	Retractors	374-486
POLITZER Ear speculas	721	Retractors for cervical spine	568-581
POLITZER Furuncle knife	735	Retractors for lumbar vertebral column	582-585
POLITZER Tympanum perforators	736	REVERDIN Abdominal and intestinal spatulas	421
POLLOSON Retractors	410	REVERDIN Ligature needles	500
Polypus and ovum forceps	356, 357	REYNOLDS Dissecting scissors	114, 156
Polypus snares	671	REYNOLDS SCT Dissecting scissors	189
POOLE Suction tubes	82, 83	REYNOLDS TC Dissecting scissors	172, 173
POPLITEA Abdominal retractors	465	Rhinoplastic knives	672, 673
Post mortem knives	55	Rhinoscopic mirrors	632
Post mortem set	1021	RHOTON Curette	840, 841
POTTS Atraumatic vascular clamps	307, 308, 315, 319, 320	RHOTON Dissector	840
POTTS-DE MARTEL Vascular scissors	136	RHOTON Elevator	840
POTTS-DE MARTEL Vascular SCT scissors	192	RHOTON Hook	841
POTTS-SMITH Dissecting forceps	201	RHOTON Needle	841
POTTS-SMITH Dissecting TC forceps	233	RHOTON Teardrop dissector	840
POTTS-SMITH Tissue forceps	213	Rib contractors	800
POTTS-SMITH Vascular scissors	117	Rib shears	764-768
POTTS-SMITH Vascular scissors	133, 136, 158	Rib Spreader	769-799
POTTS-SMITH Vascular scissors	136	Rib Spreader aluminium	769-776
POTTS-SMITH Vascular TC scissors	179	RIBBON-IRIS Delicate surgical scissors	130
Powder blowers	718	RIBBON-STEVENS Delicate surgical scissors	130
POZZI Uterine tenaculum forceps	902	RICARD Abdominal retractors	468
PRATT Antrum curettes	690	RICHARDSON Retractors	412
PRATT Peritoneum forceps	277	RICHARDSON-EASTMAN Retractors	411
PRATT Probes	64	RICHNAU-HOLMGREN Ear speculas	726
PRATT Rectal retractors	861	RICHTER Surgical scissors	97
PRATT Uterine tenaculum forceps	907	RICHTER-HEATH Clip applying forceps	518
PRECISA Blood pressure manometers	24	RIENHOFF Rib Spreader	782
PRINCE Tonsil scissors	116	RIGBY Wound spreaders, self retaining	458
PRINCE-THOMAS Bronchus clamps	802	Ring curettes	1111
PRINCE-THOMAS Lung grasping forceps	801	Ring strippers	808
Probes	62-64	RING Tongue depressors	616
Proctoscopes	862, 864	RI-RAP Stethoscopes	19
Prostatic retractors	953	RITTER Frontal sinus bougies	753
PROVIDENCE-HOSPITAL Haemostatic forceps	249	ROBB Vascular dissectors	814
PUTTI Rasps	1089	ROBERTS Dissecting and ligature forceps	269
<b>Q</b>		ROBIN MASSE Abdominal retractors	465
QUATTRO Plaster spreaders	1194	ROBIN Towel clamps	367
QUERVAIN Elevators	1074	ROCHARD Abdominal retractors	477
QUINBY Gum scissors	124	ROCHESTER-CARMALT Haemostatic forceps	245
QUINKE Liver blind puncture needles	74	ROEDER Ligature instrument	627
QUIRE Foreign body lever	731	ROEDER Towel clamps	368
<b>R</b>		ROETTGEN-RUSKIN Bone rongeurs	1134
RABINER Percussion hammer	17	ROGER Septum elevators	676
Rack for Rhoton instruments	839	ROGERS Hysterectomy Forceps	275, 276
Rack for sterilisation and storage	1225	ROGGE Sterilising Forceps	1209
RADOLF Nail nippers	1206	Roller knife	746
RAGNELL Retractors	419	ROLLET Retractors	432
RAGNELL-DAVIS Retractors	440	ROSCHKE Rectal retractors	864
RAKE Retractors	486	ROSE Retractors	419
RALK Hand drills	1172, 1173	ROSEN Curette	747
RALK Splinter Forceps	1208	ROSEN Fenestra hook	747
RAMPLEY Sponge forceps	359	ROSEN Lancet knife	747
Ramus retractors	386	ROSEN Micro needle	748, 749
RANDALL Biopsy curettes	912	ROSEN Raspatory	747
RANDALL Kidney stone forceps	875	ROSEN Round cutting knives	746
RANDALL Nephrostomy forceps	876	ROSEN Suction tubes	85
RANEY Clip applying forceps	546	ROSER-KOENIG Mouth gags	604
RANEY Scalp haemostatic clips	546	ROSS Aorta retractors	816
Raspatories	562, 563, 704, 708, 752, 831, 832, 835, 1052-1055, 1058-1071	Round Bowls	1212, 1214
Rasps	1088, 1089	Round cutting knives	746, 752, 753
RAY Curette	703	ROUX Retractors	416
Razor blade breaker and holder	825	ROUX-MAGNUS Retractors	417
Razor blades	47, 1207	RUBIN Osteotomes	681
Razor knives	58	RUBIN Septum forceps	701
Reamers	1012	RUDD Hemorrhoidal ligators	867
RECAMIER Uterine curettes	925, 926, 928	Rulers	22



RUMEL Dissecting and ligature forceps	267	SCHULTZE Salpingograph	915
RUMEL-BELMONT Ligature catchers	815	SCHUMACHER Broncho-Oesophagoscopy forceps	637
RUMEL-BELMONT Varicose vein instruments	815	SCHUMACHER Cervical biopsy and specimen forceps	920
RUSKIN Antrum trocar	87	SCHUMACHER Rib shears	764
RUSKIN Bone rongeurs	1133	SCHUMACHER Umbilical cord scissors	102
RUSKIN-LISTON Bone cutting forceps	1142	SCHUMACHER-VAN DOREN Cervical biopsy and specimen forceps	918
RUSSEL-DAVIS Tongue depressors	615	SCHWEDEN Bone curettes	1091
RUSSIAN Tissue grasping forceps	203	Scissors	91-148
RUST Amputation and resection saws	1009	Scissors with tungsten carbide edges	160-181
RYDEL-SEIFFER Tuning forks	713	SCOVILLE Bone curettes	1106
RYDER Needle holders	498	SCOVILLE Laminectomy retractors	558
RYDER-VASCULAR TC Needle holders	532	SCOVILLE Lateral valves	557, 558
<b>S</b>		SCOVILLE Nerve root retractors	552
SAALFELD Comedone extractor	61	SCOVILLE Retractors	486
SACHS Dura hooks	554	SCOVILLE-HAVERFIELD Laminectomy retractors	557
SACHS Dura-Dissectors	550, 551	SCOVILLE-RICHTER Laminectomy retractors	556
SACHSE Meatotome	948	SCOVILLE-RICHTER Lateral valves	565
SAENGER Placenta and ovum forceps	941	Scraper	748
Safety pins	372	SCT Dissecting scissors	187
SALENIUS Meniscus knives	1146	SCUDDER Stomach forceps	851
Salpingograph	915	SEBILÉAU Elevators	1074
SALYER Face-lift scissors	118	Secretion scoop	911
SAMII Lancet knives	837	SEDILLOT Raspatories	1063, 1065
SAMII Tumor knives	836, 837	SEEMANN-SEIFERT Mouth gags	605
SANTULLI Bulldog clamps	296	SEGOND Myoma knife	56
SANVENERO Delicate surgical scissors	124	SEGOND-LANDAU Hysterectomy Forceps	273
SAROT Dissecting and ligature forceps	267	SEIDL Vaginal speculas	887
SAROT Needle holders	490	SEIFFERT Broncho-Oesophagoscopy forceps	637
SAROT TC Needle holders	524	SELDIN Raspatories	1064
SATINSKY Atraumatic vascular clamps	332	Self-Retaining retractors for skull mounting	540-542
SATINSKY Vascular scissors	131	SELLHEIM Obstetric lever	936
SATINSKY Vena cava clamps	347, 348	SELLORS Rib contractors	800
SATTERLEE Amputation and resection saws	1010	SELMANN Tissue forceps	204
SAUERBRUCH Needle cases	1223	SELVERSTONE Laminectomy rongeurs	998, 999
SAUERBRUCH Retractors	382, 394	SEMB Bone cutting forceps	1144
SAUERBRUCH Rib shears	765	SEMB Bone holding forceps	1119
SAUERBRUCH Waste forceps	1218	SEMB Bone rongeurs	1139
SAUERBRUCH-CORYLLOS Bone rongeurs	1140	SEMB Bronchus clamps	802
SAUERBRUCH-FREY Rib shears	767	SEMB Raspatories	1066
SAUNDERS Instrument for removal of I.U.D	911	SEMKEN Dissecting forceps	199, 200
SAWTELL Tonsil grasping forceps	620	SEMKEN Dissecting TC forceps	232
Scalp flap forceps	936	SEMKEN Tissue forceps	208, 212
SCALP-CONTOUR Wound spreaders, self retaining	446	SEMKEN Tissue TC forceps	234, 235
Scalpel blades	48, 50	SEMM Abdominal retractors	474
Scalpel handles	44-47, 50, 823, 825, 826	SEMM Vaginal speculas	882
Scalpel-Blade Remover	48	SENN-GREEN Retractors	438
SCHAEDEL Towel clamps	368	SENNING TC Needle holders	523
SCHAMBERG Comedone extractor	61	SENN-MILLER Retractors	439
SCHÉDE Bone curettes	1095	Septum elevators	674-678
SCHÉIBE Intestinal and tissue grasping forceps	362	Septum forceps	696-699, 701, 756-760
SCHÉINMANN Broncho-Oesophagoscopy forceps	637	Septum gouges	679
SCHERBACK Vaginal speculas	894	Septum knives	672, 673
SCHIMMELBUSCH Sterilization drums	1224	Septum needles	72
SCHINDLER Peritoneum forceps	279	Septum scissors	700
SCHINK Dermatome	59	Sequester forceps	1118
SCHINK Skin fixing plate	59	Set for nurses	1207
SCHIOETZ Tonometer	23	SEUTIN Bandage and plaster-of-paris scissors	1191
SCHLESINGER Laminectomy rongeurs	1006	SEWALL Raspatories	1052, 1060
SCHMEDEN Nasal forceps	992	SEXTON Tympanum perforators	735
SCHMID Intima spatula	813	SEYFFERT Vaginal speculas	882
SCHMID Vessel irrigation cannulas	73	SHAAF Cilia forceps	223
SCHMIEDEN Ligature conductors	511	SHAMBAUGH Micro hooks	749
SCHMIEDEN Ligature needles	502	SHAMBOUGH Adenotomes	630
SCHMIEDEN-DICK Ligature needles	501	SHAPLEIGH Ear loops	729
SCHMIEDEN-PAYR Ligature conductors	511	Sharp curettes	751
SCHMIEDEN-TAYLOR Vascular scissors	133	Sharp Hook	830
SCHNEIDER Raspatories	1064	Sharpening stone	58
SCHNEIDER-SAUERBRUCH Raspatories	1065	SHEA Sharp curettes	751
SCHNIDT Haemostatic forceps	244	SHEEHAN Osteotomes	682
SCHNIDT Tonsil grasping forceps	620	Sickle knives	691, 745, 746, 748, 752
SCHOEMAKER Intestinal forceps	852	SIEGLE Aural magnifier	726
SCHOEMAKER-LOTH Ligature scissors	147	Sigmoid anastomosis forceps	855-859
SCHOENBORN Tracheal retractor	656	Silver brain clips	546
SCHROEDER Fistula knives	56	Silver clip carrier	546
SCHROEDER Uterine curettes	924	SILVER Dermatome	59
SCHROEDER Uterine tenaculum forceps	901, 903, 907	SILVER Osteotomes	683
SCHUBERT Cervical biopsy and specimen forceps	916, 917	SIMON Bone curettes	1100
SCHUHKNÉCHT Die to pre-form wire prothesis	686	SIMON Fistula knives	56
SCHUHKNÉCHT Suction tubes	89	SIMON Retractors	415, 436
SCHUKNECHT Micro wire bending forceps	741	SIMPLEX Cheek retractors	619
SCHUKNECHT Roller knife	746	SIMPSON Obstetrical forceps	932, 933
SCHUKNECHT Sickle knife	746	SIMPSON-LUIKART Obstetrical forceps	934
SCHUL Dissectomy retractors	594	SIMS Rectal retractors	861

<b>SIMS</b> Rectal speculas	862	<b>STILLE</b> Tissue forceps	207
<b>SIMS</b> Uterine curettes	900, 927, 930	<b>STILLE-BARRAYA</b> Vascular and tumor forceps	216
<b>SIMS</b> Uterine depressor	900	<b>STILLE-RUSKIN</b> Bone rongeurs	1138
<b>SIMS</b> Uterine probes	899	<b>STILLE-SHERMAN</b> Hand drills	1171
<b>SIMS</b> Uterine scissors	98, 99, 151	Stirrup hook	747
<b>SIMS</b> Uterine SCT scissors	186	<b>STOCKMANN</b> Fixation clamps	946
<b>SIMS</b> Uterine TC scissors	163, 164	<b>STOCKMANN</b> Penis clamps	946
<b>SIMS</b> Vaginal speculas	887	Stomach forceps	851
<b>SIMS-BODENHAMMER</b> Rectal retractors	861	Stone forceps	945
<b>SIMS-MAIER</b> Dressing forceps	355	<b>STONE</b> Tissue forceps	218
<b>SIMS-SIEBOLD</b> Uterine scissors	100, 152	<b>STONE-WATT</b> Closing forceps	860
<b>SINGLEY-TUTTLE</b> Tissue grasping forceps	204	<b>STONE-WATT</b> Intestinal and stomach forceps	860
Sinus forceps	352	Storing cases	1225
Sinusoscopes	599, 712	<b>STRABISMUS</b> Dissecting scissors	112
Sinusoscopy instruments	703-708	<b>STRANDELL-STILLE</b> Retractors	441
<b>SKENE</b> Uterine tenaculum forceps	903	<b>STRASSBURG</b> Tissue forceps	212
Skin fixing plate	59	<b>STRATTE</b> Needle holders	492
Skin grasping forceps	686	<b>STRATTE</b> TC Needle holders	526
Skull brakers	1021	<b>STRAUSS</b> Penis clamps	946
<b>SLUDER-BALLENGER</b> Tonsillectomies	625	<b>STRONG (COBRA)</b> Atraumatic vascular clamps	318
<b>SMELLIE</b> Decapitating Hooks	937	<b>STRUCK</b> Rib Spreader	782
<b>SMELLIE</b> Perforators	937	<b>STRUEMPEL</b> Ear forceps	734
<b>SMILLIE</b> Knee retractors	1148	<b>STRULLY</b> Vascular scissors	131
<b>SMILLIE</b> Meniscus knives	1147	<b>STRUYKEN</b> Nasal forceps	990
<b>SMITH</b> Bandage scissors	1186	<b>SUBRAMANIAN</b> Atraumatic vascular clamps	299
<b>SMITH</b> Wire cutting TC scissors	180	Suction and irrigation instruments	86-89
<b>SMITH-BUIE</b> Rectal retractors	864	Suction curettes	914
<b>SMITH-PETERSEN</b> Bone rongeurs	1134	Suction elevators	674, 678
<b>SMITH-PETERSEN</b> Gouges	1040	Suction handles	85
<b>SMITH-PETERSEN</b> Osteotomes	1039	Suction tubes	77-89
<b>SMITHWICK</b> Dura hooks	554	<b>SUPERCUT</b> scissors	150-158
Snare wires	624, 652, 671, 738	<b>SUPERCUT TITANIUM-NITRIDE</b> Scissors	184-192
<b>SNELLEN</b> Ear loops	728	Surgical needles	514-516
Soft tissue retractors	384, 385	Surgical scissors	91-97, 103-105, 151-153
Solution bowls	1212	Surgical SCT scissors	186, 187
<b>SOMER</b> Uterine grasping forceps	909	Surgical TC scissors	162, 165, 167
Special needles	72-74	Suture Clips	516
Specula for hypophysectomy	702	Suture forceps	198
Specula for lumbar vertebral operations	585	Suture needle sterilizing rack	1223
<b>SPENCER-WELLS</b> Haemostatic forceps	242	<b>SWEDISH</b> Dura-Dissectors	550
Sphincteroscopes	863	<b>SWEET</b> Clip applying forceps	547
Spinal KIT	482	Swivel knives	679
Spinal gouges	1050	<b>SYPERT</b> Bone rongeurs	1140
Splinter forceps	224-225	<b>SYPERT</b> Laminectomy punches	985
Splinter Forceps	1208	<b>SYPERT</b> Laminectomy rongeurs	987
Splitting osteotomes	1035	Syringes	74-76
Sponge forceps	349-352, 354, 355, 359	<b>SYSTRUNK</b> Nail scissors	1204
Spongiosa gouges	1045	<b>T</b>	
<b>SPRATT</b> Bone curettes	1097	<b>TABB</b> Mucosa knife	745
Spreading forceps for speculas	702	<b>TAKAHASHI</b> Laminectomy rongeurs	994
<b>SPREADY</b> Laminectomy retractors	589-591	<b>TAKAHASHI</b> Septum forceps	757
<b>SPURLING</b> Laminectomy rongeurs	997	Tampers	1024
Sputum cup	1214	Tampon and polypus forceps	669, 670
<b>ST. CLAIR-THOMSON</b> Adenoid curettes	629	Tampon plugger	626
<b>ST. MARKS</b> Rectal retractors	866	<b>TARNIER</b> Cranioclast	938
<b>ST. MARKS</b> Retractors	420	<b>TARNIER</b> Obstetrical forceps	935
<b>STACKE</b> Probes	62	<b>TAYLOR</b> Dissecting forceps	200, 201
Stainless steel holloware	1212-1217	<b>TAYLOR</b> Knee retractors	1148
<b>STANDARD</b> Trocars	69	<b>TAYLOR</b> Lateral valves	558
<b>STAUDE-MOORE</b> Uterine tenaculum forceps	901	<b>TAYLOR</b> Percussion hammer	16
<b>STEINBACH</b> Mallets	1018	<b>TAYLOR</b> Tissue forceps	212, 213
<b>STELLA</b> Face-lift TC scissors	175	<b>TAYLOR-BROWN</b> Tissue forceps	216
<b>STELLBRINK</b> Bone rongeurs	1127	T-Bar handle for wire saws	1010
<b>STELZNER</b> Rectal scissors	107	TC Dissecting scissors	167-173
Sterilising forceps	1209	TC Hysterectomy scissors	166
Sterilization drums	1224	TC Ligature scissors	181
<b>STERNBERG</b> Lip and cheek retractors	618	TC Suture forceps	236
Sternum chisel	764	<b>TEALE</b> Uterine tenaculum forceps	904
Sternum puncture needle	73	Teardrop dissectors	840
Stethoscopes	17-19	Tendon interlacing forceps	1150-1152
<b>STEVENS</b> Delicate surgical scissors	127, 156	Tendon knife	745
<b>STEVENS</b> Delicate surgical SCT scissors	191	Tendon passing forceps	1150-1152
<b>STEVENS</b> Iris forceps	197, 208	Tendon passing instruments	1153
<b>STIEGLITZ</b> Splinter Forceps	1208	Tendon stripper	1152, 1153
<b>STILLE</b> Bone rongeurs	1136	<b>TERRIER</b> Haemostatic forceps	259
<b>STILLE</b> Chisels	1032	<b>TESSIER</b> Bone contouring forceps	1118
<b>STILLE</b> Dissecting forceps	197	<b>TESSIER</b> Nasal scissors	120
<b>STILLE</b> Gall stone forceps	878	<b>TESSIER</b> Osteotomes	1033, 1036, 1037
<b>STILLE</b> Gouges	1033	<b>TESSIER</b> Raspatories	1058
<b>STILLE</b> Hand drills	1171	<b>THILENIUS</b> Tonsil abscess forceps	623
<b>STILLE</b> Kidney pedicle clamps	283, 285	Third molar retractor	387
<b>STILLE</b> Osteotomes	1032	<b>THOMS-ALLIS</b> Intestinal and tissue grasping forceps	364
<b>STILLE</b> Plaster-of-paris scissors	1192	<b>THOMS-GAYLOR</b> Cervical biopsy and specimen forceps	919



<b>THOMSON-WALKER</b> Bladder retractors	952	Tunneling Set	811
<b>THOREK</b> Dissecting scissors	113	<b>TURNBULL</b> Nail nippers	1205
<b>THOREK</b> TC Dissecting scissors	171	Twin probe	827
<b>THUDICHUM</b> Nasal speculas	660	<b>TYDING</b> Tonsil snares	624
Ticks forceps	226	<b>TYDING-TIVNEN</b> Tonsil grasping forceps	621
<b>TIECK-HALLE</b> Nasal speculas	660, 661	Tympanum perforators	735-737
<b>TILLEY</b> Tampon and polypus forceps	669	<b>U</b>	
<b>TILLEY-HENCKEL</b> Nasal forceps	989	<b>UCKERMANN</b> Cotton applicators	65
<b>TISCHLER</b> Cervical biopsy and specimen forceps	917	<b>UCKERMANN</b> Tracheotomy trocar	653
<b>TISCHLER</b> Cervical biopsy and specimen forceps	921	<b>UFFENORDE</b> Bone curettes	1114
<b>TISCHLER-KEVORKIAN</b> Cervical biopsy and specimen forceps	921	<b>ULM</b> Emergency case	28
<b>TISCHLER-MORGAN</b> Cervical biopsy and specimen forceps	921, 922	<b>ULRICH</b> Bone holding forceps	1122
Tissue forceps	204-218	<b>ULRICH</b> Fistula knives	56
Tissue grasping forceps	203, 204, 209, 217	<b>ULRICH</b> Sponge forceps	349
Tissue Pick	830	Umbilical cord clamp	937
<b>TOBOLD</b> Laryngeal polypus forceps	634	Umbilical cord scissors	102
<b>TOBOLD</b> Tongue depressors	601	<b>UNIVERSAL</b> Bandage and plaster-of-paris scissors	1191
<b>TOENNIS</b> Dissecting scissors	114	Universal Handle	636, 923
<b>TOENNIS</b> Dura hooks	555	<b>UNIVERSAL</b> Sterilising Forceps	1209
<b>TOENNIS</b> Dura knives	57, 58	<b>UNIVERSAL</b> Trocars	69
<b>TOENNIS</b> Haemostatic forceps	243, 255	<b>UNIVERSAL</b> Wire cutting scissors	148
<b>TOENNIS</b> Intima spatula	814	<b>UNIVERSAL</b> Wire cutting TC scissors	180
<b>TOENNIS</b> Needle holders	497	<b>UNNA</b> Comedone extractor	61
<b>TOENNIS</b> TC Needle holders	531	<b>UNNA-VIDAL</b> Comedone extractor	61
<b>TOENNIS-ADSON</b> Dissecting scissors	115	Urethro forceps	945
<b>TOENNIS-ADSON</b> SCT Dissecting scissors	189	Urethrotome	954
<b>TOENNIS-ADSON</b> TC Dissecting scissors	173	Urinals	1216
<b>TOHOKU</b> Towel clamps	369	<b>USA</b> Bone curettes	1108, 1109
Tongue depressors	601, 602, 615, 616	<b>USA</b> Dissecting forceps	196
Tongue spatulas	600	<b>USA</b> Plaster spreaders	1194
Tonometer	23	<b>USA</b> Tissue forceps	206
Tonsil abscess forceps	623	<b>USA</b> Umbilical cord scissors	102
Tonsil dissectors	622, 623	Uterine cannula	915
Tonsil grasping forceps	620	Uterine curettes	900, 924-930
Tonsil knife and enucleator	622	Uterine depressor	900
Tonsil knives	57, 623	Uterine dilators	897
Tonsil needles	72, 626	Uterine dressing forceps	353, 909, 910
Tonsil scissors	116, 117	Uterine probes	899
Tonsil snares	623, 624	Uterine scissors	98-100, 151, 152
Tonsil TC scissors	174	Uterine scoopes	911
Tonsillectomes	625	Uterine SCT scissors	186
Tounge holding forceps	618	Uterine TC scissors	163, 164
Tourniquet	1181	Uterine tenaculum forceps	901-908
Towel clamps	367-369	<b>V</b>	
<b>TOWNLEY</b> Caliper	22	Vaginal speculas	880-895
<b>TOYNBEE</b> Ear speculas	725	<b>VALLEIX</b> Uterine probes	899
Trachea tubes	654, 655	Valves	565
Tracheal dilators	654	<b>VAN BUREN</b> Dilating bougies	950
Tracheal retractor	655	<b>VAN BUREN</b> Sequestrum forceps	1118
Tracheostomy trocar	653	<b>VAN DOREN</b> Cervical biopsy and specimen forceps	918, 919
Traction bar for bone clamps	1126	<b>VANNAS</b> Micro scissors	140
Traction handle	936	<b>VARADY</b> Micro dissector	814
Transformers	27, 42-43	<b>VARADY</b> Phlebextractor	814
Transplantation knives	58	<b>VARADY</b> Phlebodissector	814
<b>TRAUBE</b> Percussion hammer	17	<b>VARADY</b> Varicose vein probe Set	807
<b>TRAUTMANN</b> Chisels	1029	Varicose vein instruments	815
<b>TRAUTMANN</b> Gouges	1029	Varicose vein probe Set	806, 807
<b>TRAVERS</b> Wound spreaders, self retaining	456	Vascular and tumor forceps	214, 216, 218
<b>TRELAT</b> Raspatories	1053	Vascular dilators	808, 809
<b>TRELAT</b> Vaginal speculas	882	Vascular dissectors	814
<b>TREVES</b> Tissue forceps	216	<b>VASCULAR</b> Needle holders	498
Trigeminal knives	56, 57	Vascular scissors	115, 117, 131-137, 158
Trocars	69-71	Vascular SCT scissors	191
Trocars for sinus surgery	692	Vascular TC scissors	179, 180
<b>TROELTSCH</b> Ear and nasal dressing forceps	221	<b>VEDDER</b> Tonsil snares	624
<b>TROELTSCH-JALASVIRTA</b> Ear and nasal dressing forceps	221	<b>VEIDENHEIMER</b> Sigmoid anastomosis forceps	857
<b>TROEMMER</b> Percussion hammer	16	Vein cannulas	72
<b>TROUSSEAU</b> Tracheal dilators	654	Velum retractor	627
<b>TROUTMAN-CHRIS</b> Blade breakers	47	Vena cava clamps	347, 348
<b>TROUTMAN-CHRIS</b> Blade holders	47	Ventricel of cerebrum puncture cannulas	80
<b>TUBBS</b> Aorta dilators	810	<b>VERBRUGGE</b> Bone holding forceps	1124
Tubing clamps	370-371	<b>VERHOEVEN</b> Suction tubes	89
<b>TUEBINGEN</b> Gall stone forceps	878	<b>VERRES</b> Insufflation cannula	73
<b>TUEBINGEN</b> Micro forceps	227	Vessel dilators	827
<b>TUEBINGEN</b> Micro scissors	140	Vessel irrigation cannulas	73
<b>TUEBINGEN</b> Retractors	414	Vessel knife	827, 838
<b>TUEBINGEN</b> Wound spreaders, self retaining	449	Vessel spreader	827
<b>TUFFIER</b> Intestinal and tissue grasping forceps	365	<b>VICKERS</b> Dissectors	1052
<b>TUFFIER</b> Retractors	403	<b>VICKERS</b> Drill Handles	1156
<b>TUFFIER</b> Rib Spreader	780	<b>VICKERS</b> Elevators	1052
Tumor forks	828	<b>VICKERS</b> Finger retractor	1183
Tumor knives	836, 837	<b>VICKERS</b> Hand restrainer	1182
Tuning forks	713-715	<b>VICKERS</b> Retractors	428



VICKERS Wound spreaders	1183	WILDER Lachrymal probes	63
VIDAL Lupus scraper	60	WILLET Scalp flap forceps	936
VIENNA Ligature catcher	513	WILLET-MARTEL Intestinal and tissue grasping forceps	366
Vigorimeter	21	WILLIAMS Intestinal and tissue grasping forceps	360
VIRCHOW Autopsy knives	54	WILLIAMS Wound spreaders, self retaining	464
VIRCHOW Brain knives	55	WILLIGER Bone curettes	1094, 1096
VIRCHOW Skull brakers	1021	WILLIGER Elevators	1074
VOLKMANN Bone curettes	1092, 1096, 1104, 1105	WILLIGER Mallets	1016
VOLKMANN Retractors	374, 378	WILLIGER Raspatories	1053
VOLLMAR Ring strippers	808	WILLIGER Retractors	420
VOLLMAR Vessel irrigation cannulas	73	WILMER-WALTER Nasal scissors	122
VOLTOLINI Nasal speculas	660	WILSON Uterine tenaculum forceps	904
Vomer forceps	696, 697	WINTER Placenta and ovum forceps	939, 940
Vulva spreader	896	Wire cutting forceps	1164-1170
<b>W</b>		Wire cutting scissors	148
WACHENFELDT Clip applying forceps	517	Wire cutting TC scissors	180
WAGENER Retractors	429	Wire forceps	1159-1163
WAGNER Bending instruments	1170	Wire guides	747, 752, 1158, 1159
WAGNER Bone levers	1076, 1080, 1081	Wire mesh	1155
WAGNER Delicate surgical scissors	125, 126	Wire saws	1010
WAGNER Delicate surgical TC scissors	177	Wire traction bows	1154, 1155
WAGNER Gouges	1049	WIS-FOREGGER Laryngoscopes	39
WAGNER Laminectomy rongeurs	985, 986	WITTNER Cervical biopsy and specimen forceps	920
WAGNER Mallets	1014	WOLFF Lupus curettes	60
WAGNER Raspatories	1070	WOLFF Plaster spreaders	1194
WALB Post mortem knives	55	WOODSON Dura dissectors	812
WALDMANN Episiotomy scissors	101, 152	Wound spreaders, self retaining	445-464
WALDMANN Episiotomy TC scissors	162	WRIGLEY Obstetrical forceps	935
WALDMANN Perineum scissors	101, 152	WUERZBURG Tongue depressors	616
WALDMANN Perineum TC scissors	162	WULLSTEIN Micro cup-shaped forceps	739
WALLICH Uterine scoopes	911	WULLSTEIN Raspatories	1054
WALTER Alar nasal hooklets	688	WULLSTEIN Suction handle	85
WALTER Chisels	682	WULLSTEIN Suction tubes	77, 86
WALTER Gouges	1033	WULLSTEIN Wound spreaders, self retaining	447
WALTER Osteotomes	682	YANKAUER Suction tubes	81, 82
WALTON Finger ring saws	1011	<b>Y</b>	
WALTON Rectal biopsy forceps	869	YASARGIL Dissector	835
WALTON-YANKAUER Suction tubes	81	YASARGIL Galea hooks	545
WANGENSTEEN Dissecting TC forceps	233	YASARGIL Laminectomy rongeurs	1005
WANGENSTEEN Needle holders	494	YASARGIL Ligature guide	829
WANGENSTEEN TC Needle holders	527	YASARGIL Raspatory	835
WANGENSTEEN Tissue grasping forceps	204	YASARGIL Suction tubes	80
WARTENBERG Algesimeter	20	YASARGIL Vessel knife	838
WARTENBERG pinwheel	20	YASARGIL-NICOLA Micro grasping forceps	651
WASSMUND Retractors	380	YEOMANN Rectal biopsy forceps	869
Waste forceps	1218	YOUNG Prostatic retractors	953
Water jet pistol	1226	YOUNG Toungue holding forceps	618
WATSON Dermatome	59	YOUNG-HRYNTSCHAK Ligature needles	513
WATSON-CHEYNE Dissectors	1056	<b>Z</b>	
WATSON-JONES Bone levers	1076	ZANDER Reamers	1012
WATSON-WILLIAMS Nasal forceps	993, 994	ZAUFAL Ear lever	730
WAUGH Tissue forceps	206	ZAUFAL-JANSEN Bone rongeurs	1133
WEBER Aesthesiometer	20	ZAUFAL-JANSEN Ear hooks	731
WEBER Atraumatic vascular clamps	312	ZENKER Dissecting and ligature forceps	262, 263
WEBER-LOCH Ear loops	729, 730	ZENKER Retractors	391
WEBSTER Needle holders	491	ZIEGLER Cilia forceps	223
WEBSTER TC Needle holders	525	ZIEGLER Dura knives	57
WECKER Micro scissors	139	ZIEGLER Reflex head mirror	35
Wedge osteotomes	1035	ZIELKE Gouges	1044
WEIL-BLAKESLEY Ethmoid forceps	745	ZOELLNER Ear speculas	720
WEIL-BLAKESLEY Nasal forceps	988, 989	ZOELLNER Hook	752
WEISMAN Ear curettes	729	ZOELLNER Lancet knife	752
WEISSBARTH Vaginal speculas	895	ZOELLNER Micro needle	752
WEITLANER Wound spreaders, self retaining	446, 447, 453, 454	ZOELLNER Raspatory	752
WEITLANER-BABY Wound spreaders, self retaining	449	ZOELLNER Round cutting knives	752
WELLER Meniscus and cartilage grasping forceps	1145	ZOELLNER Sickle knife	752
WERTHEIM Hysterectomy Forceps	271, 272	ZOELLNER Suction tubes	89
WERTHEIM Sigmoid anastomosis forceps	859	ZOELLNER Wire guide	752
WERTHEIM TC Hysterectomy scissors	166	Z-PARAMETRIUM Hysterectomy Forceps	286
WERTHEIM Uterine scissors	100		
WERTHEIM-CULLEN Hysterectomy Forceps	276		
WEST Chisels	1025		
WEST Gouges	1025		
WESTCOTT Micro scissors	141		
WESTMACOTT Tampon and polypus forceps	669		
WHITE Tonsil grasping forceps	620		
WHITEHEAD Mouth gags	604		
WIEDER Tongue depressors	602		
WIEN Nasal speculas	662		
WIENER Antrum rasps	693		
WIENER MOD. Hysterectomy Forceps	274		
WIGMORE Plaster knives	1195		
WIKSTROEM Dissecting and ligature forceps	269		



<b>A</b>			
Abajalenguas	601, 602, 615, 616		
<b>ABRAHAM</b> Bisturíe para amígdalas	57		
<b>ABRAHAM</b> Pinzas para amígdalas	621		
Abrebocas	603-614		
Adenótomos	630		
<b>ADLERDYCE</b> Elevadores	1055		
<b>ADLERKREUTZ</b> Pinzas para vasos y tumores	214		
<b>ADSON</b> Escariadores	1012		
<b>ADSON</b> Ganchos para dura-madré	554, 555		
<b>ADSON</b> Periostótomos	1059		
<b>ADSON</b> Pinza-guía para taladros	1012		
<b>ADSON</b> Pinzas de disección	198, 199		
<b>ADSON</b> Pinzas haemostáticas	245, 256		
<b>ADSON</b> Pinzas quirúrgicas	209, 210		
<b>ADSON</b> Pinzas-gubias	1131		
<b>ADSON</b> Porta-agujas	489		
<b>ADSON</b> Separadores, autoestáticos	453, 455, 458-461		
<b>ADSON TC</b> Pinzas de disección	232		
<b>ADSON TC</b> Pinzas quirúrgicas	234		
<b>ADSON</b> Tubos para aspiración	78		
<b>ADSON-BIEMER-MICRO</b> Pinzas quirúrgicas	211		
<b>ADSON-BROWN</b> Pinzas quirúrgicas	217		
<b>ADSON-BROWN TC</b> Pinzas quirúrgicas	235		
<b>ADSON-DE BAKEY</b> Pinzas atrauma	218		
<b>ADSON-GRAEFE</b> Pinzas quirúrgicas	217		
<b>ADSON-MICRO</b> Pinzas de disección	199		
<b>ADSON-MICRO</b> Pinzas quirúrgicas	210, 211		
<b>ADSON-MICRO TC</b> Pinzas de disección	232		
<b>ADSON-MICRO TC</b> Pinzas quirúrgicas	234		
<b>ADSON-MINI</b> Pinzas quirúrgicas	210		
<b>AGNEW</b> Aguja para paracentesis	736		
Agrafes de sutura	516		
Aguja de cerumen y aplicadores de algodón	730		
Aguja del cardioplegia	823		
Aguja hipodérmica	72		
Aguja para amígdalas	72, 626		
Aguja para el tabique nasal	72		
Aguja para heparín	73		
Aguja para ligaduras	626		
Aguja para sutura del paladar	626		
Agujas	29, 841		
Agujas de guía	66-68		
Agujas especiales	72-74		
Agujas para la punción ciega del hígado	74		
Agujas para ligaduras	500-509		
Agujas para paracentesis	735-737		
Agujas para punción del esternón	73		
Agujas pasa-hilos	1158, 1159		
Agujas quirúrgicas	514-516		
Alambre para amigdalotomo	624, 652, 671, 738		
<b>ALAN-PARKS</b> Separadores para el recto	865		
<b>ALDINGER</b> Elevadores para huesos	1081		
<b>ALEXANDER</b> Cinceles	1030		
<b>ALEXANDER</b> Gubias	1030		
<b>ALEXANDER</b> Periostótomos	1065		
<b>ALEXANDER</b> Pinzas saca-bocados para biopsia	920		
Algesímetro (rueda con espinas)	20		
Algesímetro con aguja y cepillo	20		
Alicates corta-alambres	1164-1170		
<b>ALLEN</b> Pinzas-clamps intestinales	844		
<b>ALLIS</b> Pinzas intestinales y para tejidos	363, 364		
<b>ALLIS-ADAIR</b> Pinzas intestinales y para tejidos	365		
<b>ALLISON</b> Espátulas pulmonares	800		
<b>ALM</b> Separadores, autoestáticos	446		
<b>ALY</b> Algesímetro	20		
Amigdalotomos	625		
Aminoscopio	864		
Amniótomo	903		
<b>ANDERSON-ADSON</b> Separadores, autoestáticos	453		
<b>ANESTOPHONE</b> Estetoscopio	19		
Anillos ligatura	866		
<b>ANKENEY</b> Separadores costales	774, 783		
Anoscopios	862, 863		
<b>ANVIL</b> Pinzas para cortar uñas	1206		
Apparechio per arrestare	29		
Aproximadores para costillas	800		
<b>ARKANSAS</b> Piedra afiladore	58		
<b>ARRUGA</b> Porta-agujas	496		
<b>ARRUGA TC</b> Porta-agujas	531		
Abdominal KIT II	481		
Asas auriculares	728-730		
<b>ASCH</b> Curette secreción	911		
<b>ASH</b> Pinzas para tabique nasal	698		
Atomizadores	761		
<b>AUFRICHT</b> Escofi nas nasales	1085, 1090		
<b>AUFRICHT</b> Separadores nasales	687		
<b>AUFRICHT</b> Tijeras para la cirugía plástica	115		
<b>AUVARD</b> Espéculos vaginales	895		
<b>AYRE</b> Bisturíe para cono	56		
<b>B</b>			
<b>BABCOCK</b> Pinzas intestinales y para tejidos	362, 363		
<b>BABINSKY</b> Martillo para reflejos	17		
<b>BABY-ADSON</b> Pinzas de disección y ligaduras	269		
<b>BABY-ALLIS</b> Pinzas intestinales y para tejidos	363		
<b>BABY-COLLIN</b> Separadores abdominales	466		
<b>BABY-CRILE</b> Pinzas haemostáticas	248, 257		
<b>BABY-CRILE-WOOD TC</b> Porta-agujas	523		
<b>BABY-KOCHER</b> Pinzas-clamps intestinales	844		
<b>BABY-MIKULICZ</b> Pinzas para peritoneo	277		
<b>BABY-MIXTER</b> Pinzas de disección y ligaduras	270		
<b>BABY-MOSQUITO</b> Pinzas haemostáticas	251		
<b>BABY-OVERHOLT</b> Pinzas de disección y ligaduras	270		
<b>BABY-ROUX</b> Separadores	416		
<b>BABY-SATINSKY</b> Pinzas de vena cava	347		
<b>BABY-TISCHLER</b> Pinzas saca-bocados para biopsia	921		
<b>BABY-YANKAUER</b> Tubos para aspiración	81		
<b>BACKHAUS</b> Pinzas de campo	367		
<b>BACKHAUS-KOCHER</b> Pinzas de campo	367		
<b>BACON</b> Pinzas-gubias	1129		
<b>BAGDLEY</b> Separadores para laminectomía	559		
<b>BAILEY</b> Pinzas cortantes para laminectomía	1007		
<b>BAILEY-GIBBON</b> Aproximadores para costillas	800		
<b>BAINBRIDGE</b> Pinzas haemostáticas	246		
<b>BAINBRIDGE</b> Pinzas vasculares atraumáticas	314		
<b>BAKES</b> Dilatadores para conducto biliar	872		
<b>BALFOUR</b> Separadores	485		
<b>BALFOUR</b> Separadores abdominales	470		
<b>BALFOUR USA</b> Separadores abdominales	471		
<b>BALFOUR-BABY</b> Separadores abdominales	469		
<b>BALL &amp; SOCKET</b> Pinzas de campo	368		
<b>BALLENGER</b> Cuchillos para tabique nasal,	679		
<b>BALLENGER</b> Gubias	679		
<b>BALLENGER</b> Pinzas para amígdalas	621		
<b>BALLENGER-HAJEK</b> Elevadores para tabique nasal	676		
Bandejas para instrumentos	1215, 1216		
<b>BARANY</b> Ensordecedor	716		
<b>BARBARA</b> Micro aguja	748, 749		
<b>BARNES</b> Tubos para aspiración	88		
<b>BARNHILL</b> Cuchillos para adenoides	629		
<b>BARON</b> Tubos para aspiración	88		
<b>BARR</b> Separadores para el recto	861		
Barra de tracción para pinzas porta-huesos	1126		
<b>BARRAQUER</b> Micro-tijeras	140		
<b>BARRAQUER</b> Pinzas depilatorias	223		
<b>BARRON</b> Ligadores hemorroides	867		
<b>BARSKY</b> Separadores	442		
<b>BARTH</b> Cucharillas cortantes	1092		
<b>BARTH</b> Curetas auriculares	730		
Bastidor de soporte para abre bocas	617		
Bastidor para esterilizar y conservar	1225		
<b>BAUMGARTNER</b> Pinzas para extraer alambres	1159		
<b>BAYHA</b> Mangos de bisturíes	44		
<b>BAYONET-KERRISON</b> Pinzas cortantes para laminectomía	968-975		
<b>BEACHAM</b> Amniótomo	903		
<b>BEALE</b> Ganchito	748		
<b>BEALES</b> Cuchillo para el tendón	745		
<b>BECK</b> Pinzas cortantes para laminectomía	994		
<b>BECKMANN</b> Cuchillos para adenoides	628		
<b>BECKMANN</b> Espéculos nasales	662		
<b>BECKMANN</b> Separadores, autoestáticos	459		
<b>BECKMANN-ADSON</b> Separadores, autoestáticos	462		
<b>BECKMANN-EATON</b> Separadores, autoestáticos	463		
<b>BEEBEE</b> Cizallas corta-alambres	148		
<b>BEER</b> Pinzas depilatorias	223		
<b>BEESON</b> Separadores para escayolas	1193		
<b>BELLUCCI</b> Micro tijeras auriculares	740		
<b>BENNETT</b> Elevadores para huesos	1082		
<b>BENGOLEA</b> Pinzas haemostáticas	243, 255		
<b>BENSAUDE</b> Anoscopios	862		
<b>BENSON</b> Pinzas-clamps intestinales	852		
<b>BERGER</b> Pinzas saca-bocados para biopsia	920		
<b>BERGMANN</b> Bisturíes para disección	51		
<b>BERGMANN</b> Martillos	1015		
<b>BERGMANN</b> Separadores	434		
<b>BERGMANN</b> Sierra para escayolas	1195		

<b>BERGMANN</b> Tijeras para vendajes y Cizallas para escayolas	1190	<b>BRUENINGS</b> Lupas auriculares	727
<b>BERLIN</b> Curetas para biopsia	913	<b>BRUENINGS</b> Pinzas para Broncho-esofagoscopia	637
<b>BERLIN</b> Pinzas para tubos	370	<b>BRUENINGS</b> Pinzas para tabique nasal	697
<b>BERLINER</b> Martillos para reflejos	16	<b>BRUENINGS</b> Tubos de extensión	636
<b>BERNHARD</b> Pinzas de campo	368	<b>BRUENINGS-BRUNK</b> Separadores nasales	687
<b>BERTILON</b> Calibrador	20	<b>BRUENINGS-LUCAS</b> Cinceles	1029
<b>BETHUNE</b> Costótomos	765	<b>BRUENINGS-LUCAS</b> Gubias	1029
<b>BEYER</b> Pinzas-gubias	1130, 1133	<b>BRUNETTI</b> Cinceles	1049
<b>BIEMER</b> Retractores vasculares	827	<b>BRUNNER</b> Agujas para ligaduras	502, 509
<b>BILL</b> Tractor adecuado	936	<b>BRUNNER</b> Costótomos	768
<b>BILLEAU</b> Asas auriculares	729	<b>BRUNNER</b> Pinzas para anastomosis de recto	855
<b>BIRCHER</b> Bisturías para menisco	1147	<b>BRUNNER</b> Separadores	396-398, 415
<b>BIRCHER</b> Pinzas para menisco y cartilago	1145	<b>BRUNNER</b> Sondas conductoras	509, 511
<b>BIRCHER</b> Separadores para rodilla	1148	<b>BRUNS</b> Cucharillas cortantes	1095, 1106, 1107
<b>BIRCHER-GANSKE</b> Pinzas para menisco y cartilago	1145, 1146	<b>BRUNS</b> Tijeras para vendajes y Cizallas para escayolas	1190, 1191
<b>BIRKETT</b> Pinzas haemostaticas	249	<b>BRYANT</b> Pinzas para vendajes	352
Bisturías de lanceta	837	<b>BUCHWALD</b> Espátulas linguales	600
Bisturías falcivorne	691	<b>BUCK</b> Curetas auriculares	728
Bisturías para absceso	57	<b>BUCK</b> Martillo para reflejos	16
Bisturías para cono	56	<b>BUCK</b> Miringotomo	735
Bisturías para fibroma	56	<b>BUCK</b> Pinza para cuerpos extraños	731
Bisturías para amígdalas	57, 623	<b>BUCK</b> Tijeras para ligatures	147
Bisturías para disección	51	<b>BUCK-GRAMCKO</b> Elevadores para huesos	1075
Bisturías para dura-madré	57, 58	<b>BUECHS</b> Periostótomos	1063
Bisturías para fístulas	56	<b>BUELAU</b> Trócares	70
Bisturías para menisco	1146, 1147	Bujías dilatadoras	949, 950
Bisturías para nervio trigémino	56, 57	<b>BUMM</b> Curetas uterinas	928, 929
Bisturías para uso único	49	<b>BUMM</b> Pinzas para pólipos uterinos y ovarios	356
<b>BLAKE</b> Pinzas para los cálculos biliares	877	<b>BUNNELL</b> Mondador de tendones	1152, 1153
<b>BLAKESLEY</b> Pinzas nasales	757	<b>BUNNELL</b> Perforadores de mano	1172
<b>BLAKESLEY-WIGAND</b> Pinzas nasales	991	<b>BUNT</b> Imperdibles para instrumentos	372
<b>BLOHMKE</b> Pinzas para amígdalas	621	<b>BURFORD</b> Separadores costales	775-777
<b>BLOUNT</b> Separadores para rodilla	1149	<b>BURKE</b> Pinzas saca-bocados para biopsia	920
<b>BLUMENTHAL</b> Pinzas-gubias	1128	<b>BUSCH</b> Tijera umbilicales	102
<b>BOEHLER</b> Pinzas cortantes para huesos	1142	<b>BUSHE</b> Cucharillas cortantes	1113
<b>BOEHLER</b> Pinzas-gubias	1132	<b>C</b>	
<b>BOERMA</b> Forceps obstétrico	934	<b>CAIRNS</b> Pinzas haemostaticas	251
<b>BOETTCHER</b> Tijeras para amígdalas	116	Cajas para almacenaje	1225
<b>BOIES</b> Elevadores para fracturas nasales	698	Cajas para instrumentos	1216, 1217
Bolso de la emergencia	28	Calibrador	20, 22
<b>BONACCOLTO</b> Pinza para sutura	198	<b>CANADIAN</b> Bisturías para menisco	1147
<b>BONN</b> Micro pinzas	227	Cánula para irrigación del seno maxilar	88
<b>BONN</b> Tijeras finas para cirugía	129	Cánula para punción del seno maxilar	69, 70, 87
<b>BONNEY</b> Pinzas de disección	203	Cánula para uterine	915
<b>BONNEY</b> Pinzas intestinales y para tejidos	360	Cánulas para insuflación	73
<b>BONNEY</b> Pinzas quirúrgicas	215	Cánulas para irrigación vascular	73
<b>BONNEY TC</b> Pinzas de disección	233	Cánulas para la punción del ventriculo cerebral	80
<b>BONNEY TC</b> Pinzas quirúrgicas	235	Cánulas para venas	72
<b>BOROWSKI</b> Separadores para aorta	817	Cánulas traqueales	654, 655
<b>BOSE</b> Separadores, autoestáticos	445	<b>CAPLAN</b> Tijeras para tabique nasal	700
<b>BOSE</b> Separadores para tráquea	655	Cápsulas de petri	1214
<b>BOUCHERON</b> Espéculos auriculares	723	Captador de hilos	513, 627
<b>BOWLES</b> Estetoscopio	18	<b>CARDIOBASE</b> Separadores costales	798, 799
<b>BOWMAN</b> Estilete para el canal lacrimal	62	<b>CARDIOPHONE</b> Estetoscopio	19
<b>BOYNTON</b> Porta-agujas	497	Cargador de batería	42
<b>BOYS-ALLIS</b> Pinzas intestinales y para tejidos	365	<b>CARMALT</b> Pinzas para espinas	225
<b>BOZEMANN</b> Pinzas para tampones	353	<b>CAROLL</b> Goniómetro para dedos	20
<b>BOZEMANN</b> Porta-agujas	493	<b>CAROLL</b> Pinzas para pasar tendones	1151
<b>BOZEMANN TC</b> Porta-agujas	526	<b>CARPENTER</b> Cuchillo y enucleador para amígdalas	622
<b>BOZEMANN</b> Tijeras vasculares	131	<b>CARPENTER</b> Disectores para amígdalas	622
<b>BOZEMANN-DOUGLAS</b> Pinzas para tampones	353	<b>CARREL</b> Pinzas haemostaticas	251
<b>BRAND</b> Pinzas para pasar tendones	1152	<b>CASPAR</b> Cucharillas cortantes	1101-1103
<b>BRAUN</b> Craneoclasto	938	<b>CASPAR</b> Curetas	1110
<b>BRAUN</b> Depresores uterinos	900	<b>CASPAR</b> Disecador	832, 833
<b>BRAUN</b> Espéculos vaginales	892	<b>CASPAR</b> Empujador de sutura	828
<b>BRAUN</b> Ganchos para decapitación	937	<b>CASPAR</b> Espéculos para la cirugía lumbar vertebral	585
<b>BRAUN</b> Pinzas para coger el cuello de útero	901, 908	<b>CASPAR</b> Ganchos para exploración y coagulación	834
<b>BRAUN-STADLER</b> Tijeras para episiotomía	101	<b>CASPAR</b> Mangos de bisturías	825
<b>BRAUN-STADLER</b> Tijeras para perineo	101	<b>CASPAR</b> Periostótomos	562, 563
<b>BREISKY</b> Espéculos vaginales	894	<b>CASPAR</b> Pies de rey para	559
<b>BREISKY WIENER</b> Espéculos vaginales	894	<b>CASPAR</b> Pinzas cortantes para laminectomía	987, 1000-1004
<b>BRIDGE</b> Pinzas de disección y ligaduras	264	<b>CASPAR</b> Pinzas cortantes para laminectomía, desmontable	1002, 1003
<b>BRODIE</b> Sondas acanaladas	64	<b>CASPAR</b> Pisón	1024
<b>BROM</b> Separadores	431	<b>CASPAR</b> Separadores	388
Bronchoscopia	658, 659	<b>CASPAR</b> Separadores para la cirugía lumbar vertebral	582, 584
<b>BROPHY</b> Pinzas de disección	202	<b>CASPAR</b> Separadores para la columna cervical	568-579
<b>BROPHY</b> Pinzas quirúrgicas	214	<b>CASPAR</b> Separadores para la raíz de nervios	552
<b>BROWN</b> Pinzas para agrrar tejidos	217	<b>CASPAR</b> Separadores para laminectomía	564-567
<b>BROWN</b> Porta-agujas	490	<b>CASPAR</b> Sistema distractor para el cuerpo vertebral cervical	560, 561
<b>BRUENINGS</b> Bisturíe para amígdalas	57	<b>CASTANEDA</b> Pinzas vasculares para recién nacidos	298-299
<b>BRUENINGS</b> Cierra-nudos para amígdalas	623	<b>CASTANEDA</b> Separadores costales	773, 774
<b>BRUENINGS</b> Cuchillos para el tabique nasal	672	<b>CARSTENS</b> Trócares	70
<b>BRUENINGS</b> Espátulas linguales	600	<b>CASTROVIEJO</b> Estilete para el canal lacrimal	63





CASTROVIEJO Micro pinzas	226	CONVERSE Separadores nasales	687
CASTROVIEJO Micro-tijeras	138, 139	COOLEY Dilatadores para aorta	810
CASTROVIEJO Porta-hojas	47	COOLEY Dilatadores vasculares	808
CASTROVIEJO Rompe-hojas de afeitar	47	COOLEY Gancho auricular	797
CATLIN Cuchillos para amputación	52	COOLEY Pinzas atrauma	219, 220
CAWOOD-MINNESOTA Separadores para labios y mejillas	618	COOLEY Pinzas vasculares atraumáticas	304, 305, 326, 330, 335-339, 342-345
Cepillo de limpieza	1227	COOLEY Separadores costales	769-771, 788, 789
Cepillo de uñas	1227	COOLEY Separadores para atrio	816
CHADWICK Tijeras finas para cirugía	123	COOLEY Tubos para aspiración	83
CHAPUT Pinzas intestinales y para tejidos	366	COOLEY-BECK Pinzas vasculares atraumáticas	340
CHARNLEY Separadores abdominales	475	COOLEY-LEITZ Pinzas vasculares atraumáticas	340
CHARRIÉ Sierras para amputación y resección	1009	COOPER Agujas para ligaduras	502
CHEATTLE Pinzas para esterilización	1209	COPE Separadores	440
CHELSEA Proctoscopios	862	CORDES Pinzas para Broncho-esofagoscopia	637
CHERON Pinzas para tapones	354	CORWIN Pinzas para extraer alambres	1160
CHEVALIER Separadores costales	781	CORYLLOS Costótomos	766
CHEVALIER-JACKSON Cánulas traqueales	655	CORYLLOS Separadores	395
CHILDE Pinzas aplicadoras para agrafes	517	Costótomos	764-768
CHURCH Tijeras vasculares	132	COTTLE Cinceles	680, 681
Cierra-nudos para amígdalas	623, 624, 627	COTTLE Cuchillos para rinoplastia	673
Cierra-nudos para laringología	652	COTTLE Elevadores para tabique nasal	677, 678
Cierre de la pinza	936	COTTLE Escofi nas nasales	1084
Cinzel para esternón	764	COTTLE Espéculos nasales	666-668
Cinceles	680-682, 751, 1025-1051	COTTLE Ganchito para alas de nariz	688, 689
Cinzel rompe-craneo	1021	COTTLE Martillos	1013
CINELLI Osteótomos	683	COTTLE Osteótomos	680, 1031
Cinta de celuloide	35	COTTLE Periostótomos	1060
CITELLI Pinzas cortantes para laminectomía	958	COTTLE Pinza de fijación	686
CITELLI-BEYER Pinzas cortantes para laminectomía	958	COTTLE Pinza para columela	686
Cizallas corta-alambres	148	COTTLE Separadores nasales	690
Clamp umbilical	937	COTTLE TC Tijeras para amígdalas	174
Clamps Bulldog	288-297	COTTLE Tijeras nasales	120, 122
CLAR Lámpadas frontales	26	COTTLE Torchio per cartilagine	686
CLASSON Tijeras vasculares	132	COTTLE-KAZANJIAN Pinzas cortantes para huesos	1141
CLAUS V. EICKEN Aguja para amígdalas	626	COTTLE-KNAPP Tijeras nasales	122
CLEVELAND Pinzas cortantes para huesos	1141	COTTLE-MASING Tijeras nasales	122
CLEVELAND Pinzas-gubias	1128	COTTLE-NEIVERT Ganchito para alas de nariz	689
CLOVER Pinzas para amígdalas	620	COTTLE-WALSHAM Pinzas para tabique nasal	698, 699
CLOWARD Pinzas cortantes para laminectomía	1006	COUPLAND Tubos para aspiración	82
CLOWARD Separadores para cuerpos vertebrales	592, 593	CRAFOORD Pinzas de disección y ligaduras	266
CLOWARD Separadores para la columna cervical	580, 581	CRAFOORD Tijeras para ginecología	101
CLOWARD Separadores para la raíz de nervios	553	CRAFOORD-SELLORS Pinzas de disección y ligaduras	266
COAKLEY Cánula para punción del seno maxilar	71	CRAIG Pinzas para tabique nasal	696
COAKLEY Curetas para el seno maxilar	690-692	Craneoclasto	938
COBB Curetas	1112	CREDO Cuchillas corta-callos	1207
COBB Elevadores	1072, 1073	CRILE Pinzas haemostaticas	248, 258
COBB Gubia espinal	1050	CRILE Porta-agujas	497
COBETT Dermátomos	59	CRILE Separadores	419, 430
COBRA Pinzas vasculares atraumáticas	318	CRILE-MURRAY Porta-agujas	490
COEN Cánula para uterine	915	CRILE-RANKIN Pinzas haemostaticas	246, 257
COHEN Periostótomos	1055	CRILE-WOOD Porta-agujas	490
COLCLOUGH Pinzas cortantes para laminectomía	984	CRILE-WOOD TC Porta-agujas	522
COLLER Pinzas haemostaticas	246	CRUTCHFIELD Pinzas de tracción craneal	548
COLLIER Porta-agujas	492	Cubetas para soluciones	1212
COLLIN Clamp umbilical	937	Cubetas redondas	1212, 1214
COLLIN Dinamómetro	20	Cucharilla para la vesicula biliar	873
COLLIN Espéculos vaginales	880	Cuchara medicinal	1213
COLLIN Mangos de bisturís	47	Cucharas para cálculos biliares	873, 874
COLLIN Martillos	1016	Cucharilla	706, 707, 831, 832, 840, 841
COLLIN Pelvímetro	931	Cucharilla de cerumen y ganchitos	730
COLLIN Pinzas aplicadoras para agrafes	518	Cucharillas cortantes	751, 1091-1114
COLLIN Pinzas intestinales y para tejidos	361	Cucharillas para aborta y placenta	942
COLLIN Pinzas para el útero	910	Cucharillas uterinas	924
COLLIN Pinzas para sacar órganos	358	Cuchillas corta-callos	1207
COLLIN Pinzas para vendajes	354	Cuchillo de discision	745
COLLIN Pinzas tira-lengua	618	Cuchillo del tumor	836, 837
COLLIN Separadores	420	Cuchillo en forma de hoz	745, 746, 748, 752
COLLIN Separadores abdominales	466, 467	Cuchillo en forma de rollo	746
COLLIN-DUVAL Pinza para agrarr	204	Cuchillo interóseo	53
COLLIN-HARTMANN Separadores	416	Cuchillo lanceolado	747, 752
COLLIN-LOKTITE Separadores abdominales	467	Cuchillo para dura-madré	553
COLLYER Pelvímetro	931	Cuchillo para el tendón	745
Columna vertebral KIT	482	Cuchillo para furúnculo	735
COM separadores	1057	Cuchillo para lóbulos	52, 745
Compresores urétral	946	Cuchillo para mucosa	745
Compresor	1181	Cuchillo para periostio	53, 735
Conductor de tendones	1153	Cuchillo y enucleador para amígdalas	622
Conductor para sierras de hilo	549	Cuchillos para adenoides	628, 629
CONE Curetas anulares	1111	Cuchillos para amputación	52
CONE Pinzas saca-bocado craneal	549	Cuchillos para autopsia	54, 55
CONVERSE Cuchillos para rinoplastia	673	Cuchillos para cartilago	53, 54
CONVERSE Ganchito para alas de nariz	688	Cuchillos para cerebro	55
CONVERSE Osteótomos	682	Cuchillos para cortes redondos	746, 752, 753

Cuchillos para el tabique nasal	672, 673	<b>DE MARTEL-WOLFSON</b> Pinzas-clamps anastomosis	845
Cuchillos para escayolas	1195	<b>DE MARTEL-WOLFSON</b> Porta-clamp	845
Cuchillos para mucosa	673	<b>DE VILBISS</b> Pinzas saca-bocado craneal	549
Cuchillos para órganos	55	<b>DEAN TC</b> Tijeras para amígdalas	174
Cuchillos para rajar cartílagos	672	<b>DEAN</b> Tijeras para amígdalas	116
Cuchillos para resección	53, 54	<b>DEAVER</b> Separadores	426, 427, 485
Cuchillos para rinoplástica	672, 673	<b>DEAVER</b> Tijeras para cirugía	96
Cuchillos para tabique nasal	679	<b>DECKER</b> Pinzas cortantes para laminectomía	1006
Cuchillos para transplantación	58	<b>DEJERINE</b> Martillos para reflejos	16
Cuchillos para vasos	827, 838	<b>DEMEL</b> Agujas pasa-hilos	1158
Curetas	703, 704, 706-708, 1110-1112	<b>DEMEL</b> Instrumentos para cerclaje	1158
Curetas anulares	1111	<b>DENHARDT</b> Abrebocas	603
Curetas auriculares	728-730	<b>DENNIS-BROWNE</b> Pinzas para agrar tejidos	204
Curetas de aspiración	914	<b>DENNIS-BROWNE</b> Separadores abdominales	471
Curetas para biopsia	912-914	Depresor para epíglois	633
Curetas para el seno maxilar	690-692	Depresores uterinos	900
Curetas para lupus	60	<b>DERF (WRIGHT)</b> Porta-agujas	491
Curetas uterinas	900, 925-930	<b>DERF TC</b> Porta-agujas	525
Curette secreción	911	<b>DERF-CONVERSE</b> Porta-agujas	492
Curettes uterines	911	<b>DERF-CONVERSE TC</b> Porta-agujas	525
<b>CUSCO</b> Espéculos vaginales	880-882	Dermatología	60, 61
<b>CUSHING</b> Espátulas cerebrales	543	Dermátomos	59
<b>CUSHING</b> Ganchos para dura-madré	555	<b>DERRA</b> Pinzas vasculares atraumáticas	304
<b>CUSHING</b> Pinzas cortantes para laminectomía	995, 998	<b>DESCHAMPS</b> Agujas para ligaduras	503-508
<b>CUSHING</b> Pinzas de disección	202	<b>DESJARDINS</b> Cucharas para cálculos biliares	873
<b>CUSHING</b> Pinzas quirúrgicas	213	<b>DESJARDINS</b> Pinzas para los cálculos biliares	878
<b>CUSHING</b> Separadores	430, 437, 441, 444	<b>DESJARDINS</b> Pinzas para pedículo renal	282
<b>CUSHING TC</b> Pinzas de disección	233	<b>DESJARDINS</b> Sondas exploradoras para cálculos biliares	872
<b>CUSHING-BROWN</b> Pinzas quirúrgicas	216	<b>DESMARRES</b> Separadores	436
<b>CUSHING-KOCHER</b> Separadores	437	Detergente para instrumentos	1227
<b>CUSHING-LANDOLT</b> Espéculos para hipofísectomía	702	Diapasónes	713-715
<b>CUZZI</b> Cucharillas para aborta y placenta	942	<b>DICK</b> Pinzas-Clamps para histerectomía	276
<b>CZERNY</b> Pinzas para coger el cuello de útero	906	<b>DIEFFENBACH</b> Clamps Bulldog	292
<b>CZERNY</b> Separadores	420	<b>DIETER</b> Pinzas saca-bocado	744
<b>CZERNY</b> Separadores para el recto	861	<b>DIETRICH</b> Clamps Bulldog	291
<b>D</b>		<b>DIETRICH</b> Pinzas vasculares atraumáticas	334
<b>DAHLGREN</b> Pinzas saca-bocado craneal	549	<b>DIETRICH-VASCULAR TC</b> Porta-agujas	532
<b>DAHMEN</b> Gubias	1051	Dilatador para el cuello vesical	953
<b>DAHMEN</b> Osteótomos	1051	Dilatadores para aorta	810
<b>DALE</b> Pinzas vasculares atraumáticas	329	Dilatadores para conducto biliar	872
<b>DANDY</b> Ganchos para dura-madré	554	Dilatadores para el seno frontal	753
<b>DANDY</b> Pinzas haemostáticas	249, 258	Dilatadores uterinos	897
<b>DANDY</b> Tijeras vasculares	132	Dilatadores vasculares	808, 809, 827
<b>DARDIK</b> Pinzas vasculares atraumáticas	346	Dilatatore traqueales	654
<b>DARLING</b> Separadores, autoestáticos	452	Dinamómetro	20
<b>DARTIGUES</b> Pinzas para el útero	909	<b>DINGMANN</b> Abajalenguas	615
<b>DAUBENSPECK</b> Cucharillas cortantes	1099	<b>DINGMANN</b> Abrebocas	606
<b>DAUTREY-MUNRO</b> Osteótomos	1034	<b>DINGMANN</b> Pinza para huesos	1117
<b>DAVIDSON</b> Separadores	411	<b>DIPLOMAT</b> Manómetros para la presión de la sangre	25
<b>DAVIS</b> Espátula para íntima	813	Disecadores	703, 708, 753, 831, 832, 835, 840, 1052, 1056
<b>DAVIS</b> Pinzas para esterilización	1209	Disecadores de dura-madré	550, 551, 812, 813
<b>DAVIS-BOYLE</b> Abajalenguas	616	Disecadores vasculares	814
<b>DAVIS-BOYLE</b> Abrebocas	608-612	Disector esférico	840
<b>DAVIS-MEYER</b> Abajalenguas	616	Disectores para amígdalas	622, 623
<b>DAVIS-MEYER</b> Abrebocas	607	Dispensadores de algodón	1217
<b>DAY</b> Gnachitos auriculares	731	<b>DITTEL</b> Guía para catéteres	947
<b>DE BAKEY</b> Clamps Bulldog	288, 289	<b>DIXON-LOVELACE</b> Pinzas haemostáticas	247, 257
<b>DE BAKEY</b> Dilatadores vasculares	809	<b>DOCKHORN</b> Separadores	387
<b>DE BAKEY</b> Pinzas atrauma	219, 220	<b>DOUAY</b> Pinzas saca-bocados para biopsia	920
<b>DE BAKEY</b> Pinzas vasculares atraumáticas	300-303, 309-311, 313, 314, 316, 317, 321, 322, 325, 328, 330	<b>DOUGHTY</b> Abajalenguas	615
<b>DE BAKEY</b> Separadores costales	786, 787	<b>DOUGLAS</b> Cánula para punción del seno maxilar	71
<b>DE BAKEY</b> Separadores, autoestáticos	464	<b>DOUGLAS</b> Pinzas depilatorias	223
<b>DE BAKEY TC</b> Pinzas atrauma	236	<b>DOYEN</b> Abajalenguas	602
<b>DE BAKEY TC</b> Porta-agujas	522, 523	<b>DOYEN</b> Espéculos vaginales	893
<b>DE BAKEY TC</b> Tijeras vasculares	179	<b>DOYEN</b> Perióstótomos	1066, 1067
<b>DE BAKEY TC</b> Tijeras des disección	115	<b>DOYEN</b> Pinzas de campo	368
<b>DE BAKEY</b> Tijeras vasculares	134, 135	<b>DOYEN</b> Pinzas para pólipos uterinos y ovarios	356
<b>DE BAKEY</b> Tubos para aspiración	84	<b>DOYEN</b> Pinzas-clamps intestinales	844-847
<b>DE BAKEY-BAHNSON</b> Pinzas vasculares atraumáticas	310	<b>DOYEN</b> Porta-agujas	492
<b>DE BAKEY-BECK</b> Pinzas vasculares atraumáticas	305	<b>DOYEN</b> Separadores	402
<b>DE BAKEY-CAROTIS</b> Clamps Bulldog	297	<b>DOYEN</b> Separadores abdominales	480
<b>DE BAKEY-DIETRICH</b> Clamps Bulldog	294	<b>DOYEN</b> Sondas acanaladas	63
<b>DE BAKEY-MIXTER</b> Pinzas vasculares atraumáticas	300	<b>DOYEN</b> Tijeras abdominales	97, 98
<b>DE BAKEY-MOSQUITO</b> Pinzas vasculares atraumáticas	307	<b>DOYEN</b> Tirabuzóns para mioma	908
<b>DE BAKEY-PEAN</b> Pinzas vasculares atraumáticas	306	<b>DOYEN-CHILD</b> Separadores abdominales	480
<b>DE BAKEY-RANKIN</b> Pinzas vasculares atraumáticas	307	<b>DOYEN-COLLIN</b> Abrebocas	603
<b>DE BAKEY-RUMEL</b> Pinzas vasculares atraumáticas	300	<b>DOYEN-JANSEN</b> Abrebocas	603
<b>DE BAKEY-SATINSKY</b> Clamps Bulldog	297	<b>DOYEN-STILLE</b> Separadores	408
<b>DE BAKEY-SATINSKY</b> Pinzas vasculares atraumáticas	331	<b>DRAFFIN</b> Bastidor de soporte para abrebocas	617
<b>DE LEE</b> Forceps obstrético	932	<b>DUBOIS</b> Tijeras para decapitón	100
<b>DE MARTEL</b> Conductor para sierras de hilo	549	<b>DUEHRSEN</b> Pinzas de disección	203
<b>DE MARTEL-WOLFSON</b> Pinza para cerrar los clamps	845	<b>DUEHRSEN</b> Pinzas quirúrgicas	215
		<b>DUKE</b> Trócares	71



DUNN-DAUTREY Osteótomos	1026	FAURE Pinzas-Clamps para histerectomía	272
DUPLAY Pinzas para coger el cuello de útero	902	FAVALORO Tijeras vasculares	134
DUPLAY Pinzas para vendajes	351, 352	FAVALORO Separadores costales	775
DUPLEX Estetoscopios	18	FEHLAND Pinzas para anastomosis de recto	856
DUPUY-WEISS Aguja para ligaduras	626	FEILCHENFELD Pinzas para espinas	225
DURANTE Pinzas para vasos y tumores	218	FEIN Porta-algodones	633
DUVAL Pinza para agrarr	204	FELDHEIM Compresor	1181
DUVAL Pinzas intestinales y para tejidos	360, 361	FERGUSSON Cucharas para cálculos biliares	874
DUVAL-COLLIN Pinzas intestinales y para tejidos	361	FERGUSSON Pinza para huesos	1119
<b>E</b>		FERGUSSON Pinzas para anastomosis de recto	855
ECHLIN Pinzas-gubias	1135	FERGUSSON Pinzas-clamps intestinales	853
EDER Porta-algodones	66	FERGUSSON Tijeras para cirugía	97
EICKEN Cánula para irrigación del seno maxilar	88	FERGUSSON Tubos para aspiración	78, 79
EISELSBERG Porta-agujas	497	FERGUSSON-ACKLAND Abrebocas	603
EISELSBERG Tijeras para ligatures	147	FERRIS-SMITH Pinzas quirúrgicas	215
Elevador auricular	730	FERRIS-SMITH TC Pinzas quirúrgicas	235
Elevador de succión	674, 678	FERRIS-SMITH-CUSHING Pinzas cortantes para laminectomía	979-983
Elevador para cuerpos extraños	731	FERRIS-SMITH-CUSHING Pinzas cortantes para laminectomía, desmontable	981, 983
Elevador para luxación	1083	FERRIS-SMITH-KERRISON Pinzas cortantes para laminectomía	960-967, 978
Elevadores	737, 840, 1052-1056, 1072-1074	FICKLING Pinzas de disección y ligaduras	269
Elevadores para fracturas nasales	698	FILIFORM Bujías dilatadoras	949
Elevadores para huesos	1075-1083	FINOCHIETTO Pinzas de disección y ligaduras	280
Elevadores para tabique nasal	674-678	FINOCHIETTO Porta-agujas	494
ELSAESSER Pinzas para nefrostomía	876	FINOCHIETTO Separadores costales	771-773, 784, 785
EMMET Pinzas para vendajes	354	FINOCHIETTO TC Porta-agujas	527
EMMET Separadores	436	FINSEN Separadores, autoestáticos	445
Empujador de sutura	827, 828	FINSTERER Tubos para aspiración	84
Empujador de tumor	828	FISCHER Bisturís para amígdalas	623
Endoespéculos	896	FISCHER Mondador de tendónes	1153
ENGEL Sierra para escayolas	1195	Flebodisecador	814
Ensordecador	716	Fleboextractores	808, 814
Enucleadores	705	Flexible naso-pharyngo-laryngofiberscopios	598
EPPENDORF Pinzas saca-bocados para biopsia	920, 922	FOERSTER Pinzas para tampones	359
Escariadores	1012	FOERSTER-BALLENGER Pinzas para tampones	359
Escofi nas nasales	1084-1090	FOMON Cuchillos para rinoplastia	672
Escofina para el seno maxilar	693	FOMON Escofi nas nasales	1086, 1090
Escofinas	1088, 1089	FOMON Ganchito para alas de nariz	688, 689
Escupidera	1214	FOMON Gancho en forma de anillo	689
Esfinteroscopios	863	FOMON Osteótomos	683
ESMARCH Cuchillos para escayolas	1195	FOMON SCT Tijeras nasales	189
ESMARCH Tijeras para vendajes y Cizallas para escayolas	1190	FOMON TC Tijeras para amígdalas	174
Espátula para íntima	813, 814	FOMON Tijeras nasales	118, 119, 121
Espátulas abdominales e intestinales	421	Forceps obstétrico	932-935
Espátulas cerebrales	543, 544	FORD-DIXON Ligadores hemorroides	868
Espátulas linguales	600	FORMBY Cucharilla de cerumen y ganchitos	730
Espátulas para emplasto	66	FOSTER-GILLIES TC Porta-agujas	528
Espátulas para la vesícula	953	FOWLER Bisturí para amígdalas	57
Espátulas pulmonares	800, 801	FOX Curetas para lupus	60
Espéculos auriculares	720-726	FRAENKEL Pinzas para Broncho-esofagoscopia	637
Espéculos nasales	660-668	FRAENKEL Pinzas para pólipos laríngeos	634, 635
Espéculos para el recto	861, 862	FRANCKE Aguja	29
Espéculos para hipofí sectomía	702	FRANZ Separadores abdominales	474
Espéculos para la cirugía lumbar vertebral	585	FRASER-KELLY Pinzas haemostaticas	248
Espéculos vaginales	880-895	FRAZIER Cánulas para la punción del ventriculo cerebral	80
Espejo frontal	35	FRAZIER Disecadores de dura-madré	551
Espejos laríngeos	632	FRAZIER Ganchos para dura-madré	555
Espejos para rinoscopia	632	FRAZIER Tubos para aspiración	77
Estesiometro	20	FREEMAN-GORNEY TC Tijeras para Face-lift	176
Estetoscopios	17-19	FREEMAN-KAYE TC Tijeras para Face-lift	176
Estetoscopios fetales	17	FREER Cinceles	1025
Estilete para el canal lacrimal	62, 63	FREER Cuchillos para mucosa	673
Estrigos para extensión	1154, 1155	FREER Elevadores	1054
Estuches para agujas	1222, 1223	FREER Elevadores para tabique nasal	674, 675
EVES Cierra-nudos para amígdalas	623	FREER Gubias	1025
EWALD Pinzas de disección	198	FREER Separadores	443
EWALD Pinzas quirúrgicas	209	FREER-GORNEY Elevador de succión	674
Excavador	747	FREER-JOSEPH Elevadores para tabique nasal	675
Extractore para comedones	61	FREER-YASARGIL Elevadores para tabique nasal	674
<b>F</b>		FRENZEL Espátulas linguales	600
FAHLBUSCH Cucharilla	707	FRIEDMANN-JOLL Separador de vulva	896
FAHLBUSCH Cureta	707	FRIEDMANN-MINI Pinzas-gubias	1127
FAHLBUSCH Micro-tijeras de agarre	651	FRIEDMANN-VICKERS Pinzas-gubias	1127
FANSLER Anoscopios	862	FRIITSCH Separadores	403
FARABEUF Periostótomos	1063	FRY Pinzas nasales	990
FARABEUF Pinza para huesos	1120	FRYKHOLM Pinzas-gubias	1136
FARABEUF Separadores	417	FUCHSIG Pinzas haemostaticas	247
FARABEUF-COLLIN Periostótomos	1063	FULLER Pinza para introducir para prótesis de teflon	742
FARABEUF-LAMBOTTE Pinza para huesos	1120	<b>G</b>	
FARRELL Porta-algodones	65	GALLAHER Escofi nas nasales	1085
FARRIOR Espéculos auriculares	720, 724	Ganchito	747, 748, 750, 752, 753
FAULKNER Curetas para el seno maxilar	690	Ganchito de estribo	747
FAURE Pinzas para peritoneo	278	Ganchito muy fi no	830
FAURE Pinzas saca-bocados para biopsia	916		

Ganchito para alas de nariz	688, 689	GROSS-MAIER Pinzas para vendajes	349, 350
Ganchito para el seno maxilar	747	GRUBER Espéculos auriculares	725
Ganchitos para nervios y vasos	822, 829	GRUENWALD Atomizadores	761
Gancho	706, 708, 831, 832, 841	GRUENWALD Pinzas nasales	757
Gancho auricular	792, 797	GRUENWALD-HENKE Pinzas nasales	991
Gancho de mentón	383, 1057	GRUENWALD-JANSEN Pinzas auriculares y nasales	222
Gancho en forma de anillo	689	Gubias	679, 751, 1025-1051
Gancho para galea	545	Gubias de esponjosa	1045
Ganchos para decapitación	937	Gubias espinal	1050
Ganchos para dura-madré	554, 555	Guía para catéteres	947
Ganchos para exploración y coagulación	834	Guía-ligadura	829
GARDNER Pinzas cortantes para huesos	1141	GUILLEN Elevador de succión	678
Garra para tejidos	830	GUILFORD-WRIGHT Cizallas corta-alambres	148
GARRETT Dilatadores vasculares	809	GULEKE Pinzas-gubias	1131
GAST Abajalenguas	615	GUNAR-HEY Pinzas para tubos	371
GAUSS Pinza para pericráneo	936	GUSTELLA Osteótomos	684
GELFOAM Pinzas para tabique nasal	701	GUTHRIE Separadores	432
GELLHORN Pinzas saca-bocados para biopsia	919	GUYON Bujías dilatadoras	949
GELPI Separadores	485	GUYON Guía para catéteres	947
GELPI-LOKTITE Separadores, autoestáticos	456, 457	GUYON Pinzas para pedículo renal	282-284
GELPI-SEILETZ Separadores, autoestáticos	457	GWYNE-EVANS Disectores para amígdalas	623
GEMINI Pinzas de disección y ligaduras	265	<b>H</b>	
GERALD Pinzas auriculares y nasales	222	HABERER Espátulas abdominales e intestinales	421
GERALD Pinzas de disección	202	HACKSTOCK Pinzas para extraer alambres	1161
GERALD Pinzas quirúrgicas	214	HAGLUND-STILLE Separadores para escayolas	1193
GERALD TC Pinzas de disección	233	HAIGHT Separadores costales	781
GERALD TC Pinzas quirúrgicas	235	HAJEK Martillos	1013
GERALD-BROWN Pinzas quirúrgicas	216	HAJEK Pinzas nasales	991
GERSTER Barra de tracción para pinzas porta-huesos	1126	HAJEK Tubos para aspiración	87
GERZOG Martillos	1017	HAJEK-CLAUS Pinzas cortantes para laminectomía	958
GERZOG-SEXTON Aguja para paracentesis	735	HAJEK-KOFLER Pinzas cortantes para laminectomía	959
GIERTZ-STILLE Costótomos	767	HAKANSSON Pinzas-gubias	1128
GIGLI Mango con gancho, para sierras de hilo	1010	HALLE Cucharillas cortantes	1098
GIGLI Sierras de hilo	1010	HALLE Cuchillo para dura-madré	553
GILLIES Osteótomos	1026	HALLE Elevadores para tabique nasal	674
GILLIES Pinzas de disección	199	HALSEY Porta-agujas	491
GILLIES Pinzas quirúrgicas	211	HALSEY TC Porta-agujas	524
GILLIES Porta-agujas con tijeras	495	HALSTED-MOSQUITO Pinzas haemostaticas	244, 250, 256, 258, 259
GILLIES Separadores	442	HARDY Cureta	707
GILLIES TC Pinzas quirúrgicas	234	HARDY Eucleadores	705
GILLIES TC Porta-agujas	528	HARDY Horquilla para implantar	705
GILLIES-MINI TC Porta-agujas	528	HARDY-FAHLBUSCH Disecadores	703
GILL-VERNET Separadores	438	HARGIS Seperador para el borde anterior	1057
GLASSMANN Pinzas atrauma	218	HARGIS Seperador para el cuerpo mandibular	1057
GLOVER Clamps Bulldog	290, 296	HARKEN Pincas de vena cava	348
GLOVER Pinzas vasculares atraumáticas	303, 315, 316	HARKEN Pinzas vasculares atraumáticas	334
GLUCK Costótomos	764	HARRINGTON Separadores	409
Gnachitos auriculares	730, 731	HARRINGTON Separadores	485
GOLDMANN Elevadores para fracturas nasales	698	HARRINGTON-PEMBERTON Separadores	409
GOLDMANN-FOX TC Tijeras para encías	177	HARTMANN (FRENCH) Diapasónes	713
GOLDMANN-FOX Tijera para encías	125	HARTMANN Abajalenguas	601
GOELET Separadores	418	HARTMANN Diapasónes	713-715
GOMEL Micro-tijeras	143	HARTMANN Espéculos auriculares	721-723
Goniómetro	20	HARTMANN Espéculos nasales	661, 662
Goniómetro para dedos	20	HARTMANN Gnachitos auriculares	731
GOOD Tijeras para amígdalas	117	HARTMANN Pinzas auriculares	732, 733
GOOD-SCHWENDECK Tijeras para amígdalas	117	HARTMANN Pinzas haemostaticas	250
GORNEY TC Tijeras para Face-lift	175	HARTMANN Pinzas nasales	992
GORNEY Tijeras des disección	113	HARTMANN Pinzas para pólipos auriculares	732
GORNEY-FREEMAN TC Tijeras para Face-lift	176	HARTMANN Pinzas para tamponamiento y pólipos nasales	669, 670
GOSSET Separadores abdominales	469	HARTMANN Pinzas-clamps intestinales	846
GOSSET-BABY Separadores abdominales	469	HARTMANN Pinzas-gubias	1129
GOURDET Cucharillas uterinas	924	HARTMANN Porta-algodones	633
GRAEFE Bisturries para disección	51	HARTMANN Sondas auriculares	716
GRAEFE Pinza para coger la piel	686	HARTMANN-HALLE Espéculos nasales	661
GRAEFE Pinzas para agrrar tejidos	209	HARTMANN-HOFFMANN Pinzas auriculares	733
GRAEFE Pinzas para iridectomía	197, 208	HARTMANN-NOYES Pinzas auriculares	733
GRAEFE Separadores	429, 431	HARTMANN-WEINGAERTNER Pinzas auriculares	733
GRAEFE Tijeras finas para cirugía	129	HARTMANN-WULLSTEIN Pinzas auriculares	732
GRAHAM Ganchos para dura-madré	554	HARVEY Cizallas corta-alambres	148
Grapas de plata	546	HARVEY-JACKSON Separadores, autoestáticos	463
GRAVE Espéculos vaginales	883, 884, 886, 887	HASLINGER Separador para velo del paladar	627
GRAY Pinzas de disección y ligaduras	280	HASOBUCCHI Horquilla	706
GREEN-ARMYTAGE Pinza-clamp uterina	936	HATFIELD Cucharillas cortantes	1112, 1113
GREGORY Pinzas vasculares atraumáticas	326	HAYES Pinzas para anastomosis de recto	857
GREGORY SCT Tijeras para Face-lift	190	HEANEY Pinzas-Clamps para histerectomía	274
GREGORY TC Tijeras para Face-lift	175	HEANEY Porta-agujas	492
GREGORY-SOFT Clamps Bulldog	297	HEANEY TC Porta-agujas	526
GREVEN Micro pinzas para plegar alambre	741	HEANEY-RAZAK Pinzas-Clamps para histerectomía	274
GREY-TURNER Pinzas haemostaticas	256	HEANLEY Pinzas-gubias	1127
GRONINGEN Ganchos para dura-madré	554	HEART-GATE Aguja del cardioplegia	823
GROSS Asas auriculares	730	HEART-GATE Ganchitos para nervios y vasos	822
GROSS Pinzas para vendajes	350, 351	HEART-GATE Gancho auricular	792, 793





HEART-GATE Imán de barra	822	HUDSON Perforadores de mano	1172
HEART-GATE Instrumentos para como mínimo la cirugía	818-823	HUGHES Ganchito de estribo	747
HEART-GATE Mango de bisturí	823	HUMBY Dermátomos	59
HEART-GATE Pinza de introducción de la lámina auricular	820	HUNTER Pinzas para espinas	225
HEART-GATE Portas ligaduras	822	HURD Aguja para sutura del paladar	626
HEART-GATE Regla de la sutura	823	HURD Disectores para amígdalas	622
HEART-GATE Separadores costales	791, 792	HUSFELDT Pinzas vasculares atraumáticas	327
HEART-GATE Soportes de valve auriculares	820	<b>I</b>	
HEART-GATE Valve auriculares	820	I.M.A. Separadores mamaria	794-797
HEATH Martillos	1015	Imán de barra	822
HEATH Tijeras para ligatures	147	Imperdibles para instrumentos	372
HEGAR Dilatadores uterinos	897, 898	INGE Separadores para cuerpos vertebrales	592
HEGAR Porta-agujas	488	Instrumental cirugía cardiaca (corazón)	824
HEGAR TC Porta-agujas	521	Instrumental para grapar	546, 547
HEGAR-BAUMGARTNER Porta-agujas	490	Instrumento para remoer dispositivo tintrauterino	911
HEGAR-BAUMGARTNER TC Porta-agujas	524	Instrumentos de aspiración y irrigación	86-89
HEGAR-VASCULAR TC Porta-agujas	532	Instrumentos de flexión	1170
HEGEMANN-DIETRICH SCT Tijeras vasculares	191	Instrumentos para cerclaje	1158
HEGEMANN-DIETRICH TC Tijeras vasculares	180	Instrumentos para circuncisión	956
HEGEMANN-DIETRICH Tijeras vasculares	137, 158	Instrumentos para como mínimo la cirugía	818-823
HEGENBARTH Pinzas aplicadoras para agrafes	517	Instrumentos para cuerpos extraños	731
HEIFETZ Espátulas cerebrales	543	Instrumentos para examen y medidas	20-22
HEIMING Pinzas para nefrostomía	874	Instrumentos para introducir catéteres	947
HEISS Pinzas haemostaticas	244, 256	Instrumentos para microcirugía	827-841
HEISTER Abrebocas	603	Instrumentos para ORL	595-761
HELFFERICH-BIER Sierras para amputación y resección	1009	Instrumentos para sinuscopía	703-708
HEMINGWAY Cucharillas cortantes	1093	Instrumentos para varices	815
HENDERSON Separadores, autoestáticos	449	Insufladores de aire	716, 717
HENKE Disectores para amígdalas	622	IOWA Aguja hipodérmica	72
HENLEY Pinzas vasculares atraumáticas	331	IOWA Pinzas para coger el cuello de útero	905
HENLEY Separadores, autoestáticos	450, 451	IRIS SCT Tijeras finas para cirugía	191
HENNIG Separadores para escayolas	1193	IRIS TC Tijeras finas para cirugía	178
HEPP-SCHIEDL Micro-tijeras	143	IRIS Tijeras finas para cirugía	127-129, 157
HERBERHOLD Abajalenguas	616	Irrigadores	1215
HERMANN Cinceles	751	IRWIN Separadores, autoestáticos	456
HERMANN Gubia	751	ISRAEL Separadores	380
HERMANN Martillo	751	ITERSON Separadores para tráquea	655
HERRICK Pinzas para pedículo renal	283	IVES-FANSLER Anoscopios	863
HERTZLER Separadores costales	780	<b>J</b>	
HERZ Pinzas para menisco y cartilago	1145	JABALEY Tijeras finas para cirugía	130, 157
HERZ Pinzas para pasar tendones	1150	JACKSON Espéculos vaginales	893
HESS Clamps Bulldog	292	JACKSON Pinzas para pasar tendones	1150
HEY-GROVES Pinza para huesos	1123	JACKSON Separadores para tráquea	656
HEYMANN Pinzas para tabique nasal	696	JACKSON-BURROWS Separadores, autoestáticos	457
HEYMANN SCT Tijeras nasales	190	JACOBS Pinzas para coger el cuello de útero	906
HEYMANN Tijeras nasales	120, 156	JACOBSON Cucharillas cortantes	1091
HEYMANN-KNIGHT Pinzas para tamponamiento y pólipos nasales	670	JACOBSON Cuchillos para vasos	827, 838
HEYWOOD-SMITH Pinzas para pólipos uterinos y ovarios	357	JACOBSON Empujador de sutura	827, 828
HIBBS Cinceles	1038	JACOBSON Sonda abotonata	827, 828
HIBBS Gubias	1039	JACOBSON Sonda doble	827
HIBBS Osteótomos	1038	JAEGER Pinzas para menisco y cartilago	1145
Hilos de cerclaje	1157	JAEGER Pinzas para pasar tendones	1151
HIRSCHMANN Anoscopios	863	JAMESON Calibrador	22
HOEN Disecadores de dura-madré	551	JAMESON Porta-agujas	492
HOEN Periostótomos	1068	JAMESON SCT Tijeras des disección	189
HOEN Pinzas para laminectomía	1007	JAMESON TC Tijeras des disección	172
HOEN V. EICKEN Captador de hilos	627	JAMESON Tijeras des disección	114, 155
HOESEL Separadores	408	JANET Jeringas	75, 76
HOESEL TC Porta-agujas	530	JANSEN Cucharillas cortantes	1091, 1092
HOFF Pinzas de campo	369	JANSEN Curetas auriculares	730
HOHMANN Elevadores para huesos	1077-1079	JANSEN Lámpadas frontales	27
Hojas de afeitar	47, 1207	JANSEN Periostótomos	1060, 1064
Hojas de bisturí	48, 50	JANSEN Pinzas auriculares y nasales	222
HOKE Osteótomos	1037	JANSEN Pinzas-gubias	1129, 1130
HOLINGER Laringoscopios para operaciones	641	JANSEN Separadores, autoestáticos	446
HOLSHER Separadores para la raíz de nervios	553	JATHO Pinzas naso-faringeas	631
HOLZBACH Pinzas haemostaticas	258	JAVID Pinzas vasculares atraumáticas	326, 327
HOLZBACH Separadores abdominales	475	JENNINGS Abrebocas	605
HOLZHEIMER Separadores, autoestáticos	445	Jeringa de laringeos	76
HOPKINS Cuchillos para escayolas	1195	Jeringas	74-76
Horquilla	747, 752	Jeringas auriculares	719
Horquilla de hilos	513	JIKEI Pinzas nasales	759, 760
Horquilla para implantar	705	JOBSON-HORNE Porta-algodones	65
HORSLEY Separadores para la raíz de nervios	552	JOHN-HOPKINS Clamps Bulldog	292, 293
Hosterómetros	899	JOHN-HOPKINS Pinza para poner los clamps bulldog	293
HOUSE Cucharilla cortantes	751	JOHNS-HOPKINS Pinzas de disección y ligaduras	281
HOUSE Micro aguja	748	JONES Pinzas de campo	369
HOUSE Periostótomo	747	JORGENSEN Tijeras vasculares	132
HOUSE Separadores para tráquea	656	JOSEPH Cuchillos para el tabique nasal	673
HOUSE Tubos para aspiración	86	JOSEPH Cuchillos para rinoplastia	672, 673
HOUSE-DIETER Pinzas saca-bocado	742	JOSEPH Elevadores para tabique nasal	677
HOWARTH Elevadores para tabique nasal	678	JOSEPH Escofi nas nasales	1084
HUBER Mango universal	636, 923	JOSEPH Periostótomos	1053

JOSEPH SCT Tijeras finas para cirugía	190	KNIGHT Pinzas para tabique nasal	696
JOSEPH Separadores	443	KNIGHT Tijeras nasales	121
JOSEPH Sierras nasales	685	KNIGHTON Separadores para cuerpos vertebrales	593
JOSEPH TC Tijeras des disección	172	KNOWLES Tijeras para vendajes	1186
JOSEPH TC Tijeras finas para cirugía	177	KOCHER Agujas para ligaduras	502
JOSEPH Tijeras finas para cirugía	123	KOCHER Espátulas para la vesícula	953
JOSEPH-MASING Elevadores para tabique nasal	677	KOCHER Pinzas haemostaticas	254, 255
JUDD-ALLIS Pinzas intestinales y para tejidos	365	KOCHER Pinzas-clamps intestinales	846, 848
JUDD-MASSON Separadores para la vejiga	952	KOCHER Separadores	376, 392, 399, 404
Juego de autopsia	1021	KOCHER Sonda para bocio	657
Juego para diagnóstico	30-35	KOCHER-LANGENBECK Separadores	389, 390
Juego para tunelar	811	KOCHER-WAGNER Separadores	405
Juego para varices	806, 807	KOELNER Pinza haemostática para cuero cabelludo	546
JUERS Micro pinzas para plegar alambre	742	KOENIG Diapasones	714
JURASZ Pinzas naso-faringeas	631	KOENIG Elevadores	1052
JURASZ Pinzas para pólipos laríngeos	634	KOENIG Periostótomos	1053
<b>K</b>		KOENIG Separadores	437
KABIERSKE Pulverizadores	718	KOENIG Sondas conductoras	512
KADER Separadores	425	KOERTE Separadores	379, 424
KAHN Tijeras para Face-lift	117	KOGAN Endoespéculos	896
KALLMORGEN Espéculos vaginales	891	KONRICH Tambores para esterilización	1224
KALT Porta-agujas	497	KOOS Cuchillos para vasos	838
KANE Clamp umbilical	937	KRAEMER Periostótomos	1063
KANTROWITZ Pinzas de disección y ligaduras	266	KRAEMER Separadores	388
KARLIN-CRANK Separadores para laminectomia	588	KRAUS Cuchillos para vasos	838
KATSCH Extractore para comedones	61	KRAUSE Cánula para punción del seno maxilar	71
KATZIN Micro-tijeras	142	KRAUSE Pinzas para Broncho-esofagoscopia	637
KATZIN-BARRAQUER Micro-tijeras	142	KRAUSE Polipótomos	671
KAYE TC Tijeras para Face-lift	175	KRAUSE Polipótomos auriculares	738
KAYE Tijeras para Face-lift	118	KRAUSE-VOSS Polipótomos	671
KAYE-MILLARD Separadores	444	KRAUSE-VOSS Polipótomos auriculares	738
KELLY Esfinteroscopios	863	KRAYENBUEHL Ganchitos para nervios y vasos	829
KELLY Pinzas de disección y ligaduras	270	KRESSNER Pinzas para tabique nasal	699
KELLY Pinzas haemostaticas	249	KRISTELLER Espéculos vaginales	889-890
KELLY Pinzas para pólipos uterinos y ovarios	356	KRISTELLER WIENER Espéculos vaginales	891
KELLY SCT Tijeras finas para cirugía	190	KROENLEIN Pinzas haemostaticas	251
KELLY Separadores	406, 412, 413, 485	KRONECKER Agujas para ligaduras	502
KELLY TC Tijeras finas para cirugía	177	KUEHNE Pinzas porta-laminillas	226
KELLY Tijeras finas para cirugía	123, 156	KUEMMEL Separadores	401, 424
KELLY-RANKIN Pinzas haemostaticas	247	KUESTNER Pinzas para coger el cuello de útero	904
KELMAN-MC PHERSON Micro pinzas	227	<b>L</b>	
KERN-LANE Pinza para huesos	1119, 1121	LA FORCE Adenótomos	630
KERPEL Cucharillas cortantes	1114	LA GRANGE Tijera para encías	124
KERRISON Pinzas cortantes para laminectomia	958, 976, 977	LABORDE Dilatatore traqueales	654
KERSTING Pinzas para anastomosis de recto	858	LACK Abajalenguas	601
KEVORKIAN Curetas para biopsia	912	LAHEY Pinzas de disección y ligaduras	280, 281
KEVORKIAN Pinzas saca-bocados para biopsia	920, 922	LAHEY Pinzas para coger el cuello de útero	908
KEVORKIAN-PACIFIC Pinzas saca-bocados para biopsia	921	LAHEY Pinza de sugestión para bocio	657
KEY Periostótomos	1068	LAHEY Separadores	438
KEYES Trépanos para piel	60	LAMBERT-KAY Pinzas vasculares atraumáticas	330
KIELLAND Forceps obstétrico	933	LAMBOTTE Osteótomos	1034
KILLIAN Elevadores	1055	LAMBOTTE Periostótomos	1065
KILLIAN Elevadores para tabique nasal	678	LAMBOTTE Pinza para huesos	1124, 1125
KILLIAN Espéculos nasales	663-666	LAMBOTTE Separadores	378
KILLIAN Gubias	679	Lámpadas frontales	26-27
KILLIAN Periostótomos	1055	LANDAU Espéculos vaginales	893
KILLIAN Pinzas para tamponamiento y pólipos nasales	670	LANDAU Trócares	71
KILLIAN Porta-algodones	633	LANDOLT Cucharilla	706
KILLIAN Tijeras para tabique nasal	700	LANDOLT Cureta	706
KILLIAN-CLAUS Gubias	679	LANDOLT Enucleadores	706
KILLIAN-RUDERT Espéculos nasales	665	LANDOLT Gancho	706
KILNER (RAGNELL) Tijeras des disección	113, 155	LANDOLT Mangos de bisturíes	826
KILNER Ganchito para alas de nariz	688	LANDOLT Periostótomos	562
KILNER Porta-agujas	491	LANDOLT Pinza retractora para espéculos	702
KILNER Separadores	419, 439, 442	LANDOLT Pinzas cortantes para laminectomia	1005
KILNER TC Porta-agujas	525	LANDOLT Tijeras nasales	121
KILNER TC Tijeras des disección	172	LANDOLT-REULEN Cureta	708
KILNER Tijeras finas para cirugía	126	LANDOLT-REULEN Disecadores	708
KILNER-DOUGHTY Abrebocas	613	LANDOLT-REULEN Legra	708
KIRK Martillos	1017	LANDON Espéculos vaginales	892
KIRKLIN Separadores	438	LANE Elevadores para huesos	1076
KIRSCH Separadores	388	LANE Pinzas de campo	368
KIRSCHNER Estribos para extensión	1154, 1155	LANE Pinzas quirúrgicas	215
KIRSCHNER Separadores abdominales	472, 473	LANE Pinzas-clamps intestinales	853
KIRSCHNER Sondas conductoras	510, 511	LANE-TRETHOWAN Elevadores para huesos	1076
KLAPP Separadores	433	LANGE Pinzas para Broncho-esofagoscopia	637
KLEINERT-KUTZ Pinzas para pasar tendones	1152	LANGE Separadores	436
KLEINERT-KUTZ Pinzas-gubias	1127, 1132	LANGE Tijeras para vendajes	1186
KLEINERT-KUTZ Separadores	444	LANGE-HOHMANN Elevadores para huesos	1079, 1080
KLEINSCHMIDT Pinzas-clamps intestinales	852	LANGENBECK Asas auriculares	728
KLIMA-ROSEGGER Agujas para punción del esternón	73	LANGENBECK Cuchillos para amputación	52
KLINKENBERGH-LOTH Tijeras vasculares	131	LANGENBECK Cuchillos para resección	53
KNAPP Separadores	432	LANGENBECK Elevadores	1074



LANGENBECK Periostótomos	1064	LOWMAN-HOGLUND Pinzas porta-huesos	1126
LANGENBECK Pinza para huesos	1118	LUBET-BARBON Pinzas para tamponamiento y pólipos nasales	669
LANGENBECK Protección del dedo	619	LUC Pinzas para tabique nasal	697
LANGENBECK Separadores	381-383	LUCAE Agujas para paracentesis	737
LANGENBECK Sierras para amputación y resección	1010	LUCAE Diapasónes	713, 714
LANGENBECK TC Porta-agujas	531	LUCAE Martillos	1016
LANGENBECK-RYDER TC Porta-agujas	534	LUCAE Pinzas auriculares y nasales	221, 222
LANGE-WILDE Polipótomos	671	LUCAE Separadores	429
LANGE-WILDE Polipótomos auriculares	738	LUCAS Cucharillas cortantes	1091
LANG-STEVENSON Pinzas-clamps intestinales	852	LUER Cánulas traqueales	654
Laringología	652, 653	LUER Jeringas	74
Laringoscopios de luz fría y accesorios	40-41, 43	LUER Pinzas intestinales y para tejidos	366
Laringoscopios para operaciones	638-641	LUER Pinzas-gubias	1128, 1130
Laringoscopios y accesorios	36-43	LUER Separadores	419
LAWRENCE Pinzas de disección y ligaduras	264	LUER-FRIEDMANN Pinzas-gubias	1127
LEBSCHKE Cíncel para esternón	764	LUER-KOERTE Cucharas para cálculos biliares	873
LEBSCHKE Conductor para sierras de hilo	549	LUER-LOCK Jeringas	74,76
LEES Pinzas vasculares atraumáticas	314, 323	LUER-STILLE Pinzas-gubias	1138, 1139
Legra	704, 708, 752, 831, 832, 835	LUKART-BILL Cierre de la pinza	936
LEGUEU Espátulas para la vesícula	953	LUKENS Separadores para tráquea	656
LEGUEU Separadores para la vejiga	952	LUNIATSCHEK Taponador	626
LEKSELL Pinzas-gubias	1137	Lupas	23
LEKSELL-STILLE Pinzas-gubias	1137	Lupas auriculares	726, 727
LELAND-JONES Pinzas vasculares atraumáticas	317-319	LURZ Pinzas para los cálculos biliares	877
LEMPERT Cucharillas cortantes	1098	<b>M</b>	
LEMPERT Elevadores	737	M.G. HOSPITAL Porta-agujas	489
LEMPERT Periostótomos	1054	MAGILL Pinzas para introducir catéteres	944
LEMPERT Tubos para aspiración	80	MAGILL Tubos para aspiración	79
LERCHE Pinzas quirúrgicas	218	MAINGOTT Pinzas-Clamps para histerectomía	275
LERICHE Pinzas haemostáticas	247, 257	Malla de alambre	1155
LERICHE Separadores	423	MALTZ Escofi nas nasales	1085, 1087
LEWIN Pinzas para reducción	1116	Mango con gancho, para sierras de hilo	1010
LEWIS Escofi nas nasales	1084	Mango de pila del Laringoscopios	42-43
LEWKOWITZ Pinzas para cálculos	945	Mango para aspiración	85
LEXER Cinceles	1042	Mango universal	636, 923
LEXER Gubias	1043, 1044, 1048	Mangos de bisturios	44-47, 50, 823, 825, 826
LEXER Gubias de esponjosa	1045, 1048	MANNERFELT Gubias	1181
LEXER Osteotomos	1043, 1047	MANNERFELT Osteotomos	1181
LEXER SCT Tijeras des disección	188	MANNERFELT Periostótomos	1180, 1181
LEXER TC Tijeras des disección	171	MANNERFELT Separadores	1178-1180
LEXER Tijeras des disección	112, 155	Manómetros para la presión de la sangre	24-25
LEXER-BABY Tijeras des disección	112	Manoplas de plomo	1182
LEXER-MINI Gubias	1041	Marcadores para areola	21
LEXER-MINI Osteotomos	1041	MARKWALDER Pinzas-gubias	1139
LEYLA Separadores para la fijación del cráneo	540-542	MARQUARDT Pinzas-gubias	1133
LICHTENBERG Porta-agujas	497	MARSCHIK Pinzas para amígdalas	620
LICHTENBERG TC Porta-agujas	530	MARSCHIK-KRONE Pinzas para amígdalas	621
LICHTWITZ Cánula para punción del seno maxilar	70, 87	Martillos	751, 1013-1020
Ligadores hemorroides	866-868	Martillos para reflejos	16, 17
Limas para uñas	1206	MARTIN Cuchillos para escayolas	1195
LISTER Bujías dilatadoras	950	MARTIN Hosterómetros	899
LISTER Pinzas para vendajes	352	MARTIN Pelvímeter	931
LISTER Tijeras para vendajes	1187	MARTIN Pinzas para desechos	1218
LISTER Tijeras para vendajes y Cizallas para escayolas	1190	MARTIN Pinzas para menisco y cartilago	1146
LISTON Cuchillos para amputación	52	MARTIN Pinzas para vendajes	351
LISTON Pinzas cortantes para huesos	1141-1143	MARTIN Porta-algodones	65
LISTON-KEY Pinzas cortantes para huesos	1144	MARTIN Separadores	375, 377, 414
LISTON-STILLE Pinzas cortantes para huesos	1143	MARTIN Sierras para abrir anillos	1011
LITTAUER Pinzas depilatorias	223	MARTIN Tijeras para cartilago	116
LITTAUER Pinzas para pólipos auriculares	732	MARTIN-CUSHING Periostótomos	1071
LITTAUER Pinzas para tamponamiento y pólipos nasales	670	MARTINI Cucharillas cortantes	1091
LITTAUER Tijeras para ligatures	147	MARTIN-LANGENBECK Periostótomos	1071
LITTLE Separadores	438	MASING Cuchillos para rajar cartilagos	672
LITTLER Tijeras finas para cirugía	126	MASING Elevadores para tabique nasal	677
LITTLER Tijeras para ligatures	147	MASING Pinzas auriculares	734
LITTLEWOOD Pinzas intestinales y para tejidos	365	MASING Separadores nasales	690
LLOYD-DAVIES Tijeras rectales	106	MASSON Porta-agujas	493
LLOYD-DAVIES Pinzas para anastomosis de recto	856	MASSON TC Porta-agujas	527
LOCKHART-MUMMERY Sondas	64	MASSON-LUETHY Porta-agujas	494
LOCKLIN TC Tijeras para encías	178	MASTIN Pinza-clamp para músculos	657
LOCKLIN Tijeras vasculares	133	MATHIEU Espéculos vaginales	892
LOCKWOOD Pinzas intestinales y para tejidos	362	MATHIEU Pinzas para cuerpos extraños	948
LOCKWOOD-ALLIS Pinzas intestinales y para tejidos	365	MATHIEU Porta-agujas	496
LOPEZ-REINKE Disectores para amígdalas	622	MATHIEU Separadores	418
LORENZ Tijeras para vendajes y Cizallas para escayolas	1190	MATHIEU Separadores para el recto	861
LORNA (EDNA) Pinzas de campo	369	MATHIEU TC Porta-agujas	528, 529
LOUTE Instrumentos para cerclaje	1158	MATHIEU-RYDER TC Porta-agujas	534
LOVE Separador para velo del paladar	627	MATZENAUER Espéculos vaginales	892
LOVE Separadores para la raíz de nervios	551, 552, 553	MAUNDER Tornillo oral	619
LOVE-GRUENWALD Pinzas cortantes para laminectomía	996	MAXIMUS Manómetros para la presión de la sangre	24
LOVELACE Pinzas para coger el pulmón	801	MAYFIELD Pinzas-gubias	1132
LOWER Pinzas de disección y ligaduras	281	MAYO Cucharas para cálculos biliares	874
LOWMAN Pinzas porta-huesos	1126	MAYO Espátulas linguales	600

MAYO Imperdibles para instrumentos	372	MICRO-RYDER TC Porta-agujas	532
MAYO SCT Tijeras para cirugía	186	Micro-tijeras	138-143
MAYO TC Tijeras para cirugía	165	Micro-tijeras de agarre	644, 646, 651
MAYO TC Tijeras para ligatures	181	MICRO-VASCULAR TC Porta-agujas	532
MAYO Tijeras para cirugía	103, 152	MIDDELDORPF Separadores	400
MAYO-ADAMS Separadores, autoestáticos	449	MIDDLETON-JANSEN Pinzas para tabique nasal	699
MAYO-BLAKE Pinzas para los cálculos biliares	877	MIKULICZ Pinzas para peritoneo	277-279
MAYO-GUYON Pinzas para pedículo renal	285	MIKULICZ Separadores	392, 393
MAYO-HARRINGTON SCT Tijeras para cirugía	186	MILAN Curetas para biopsia	914
MAYO-HARRINGTON TC Tijeras para cirugía	165	MILIGAN Separadores, autoestáticos	449
MAYO-HARRINGTON Tijeras para cirugía	105, 153	MILLARD (COTTLE) Gancho en forma de anillo	689
MAYO-HEGAR Porta-agujas	488, 489	MILLER Cucharillas cortantes	1092
MAYO-HEGAR TC Porta-agujas	521	MILLER Escofi nas nasales	1087
MAYO-LEXER TC Tijeras des disección	171	MILLER Laringoscopios	37
MAYO-NOBLE Tijeras para cirugía	105	MILLER Laringoscopios de luz fría	41
MAYO-ROBSON Pinzas-clamps intestinales	850	MILLER-COLBURN Cucharillas cortantes	1094
MAYO-RUSSIAN Pinzas para agrrrar tejidos	203	MILLER-COLBURN Escofi nas nasales	1088
MAYO-STILLE SCT Tijeras para cirugía	187	MILLIGAN Disecadores de dura-madré	550
MAYO-STILLE TC Tijeras para cirugía	167	MILLIN Dilatador para el cuello vesical	953
MAYO-STILLE Tijeras para cirugía	104, 153	MILLIN Pinzas capsulares	955
MC CLINTOCK Pinzas para aborta y placenta	940	MILLIN Separadores para la vejiga	952
MC CLURE Micro-tijeras	138	MILLS Tijeras vasculares	137
MC CULLOCH Seperadores para laminectomia	586,587	MINI-HOHMANN Elevadores para huesos	1075
MC DONALD Periostótomos	1055	MINI-LAMBOTTE Osteótomos	1030, 1031
MC GEE Gancho	750	MINI-LANGENBECK Separadores	439
MC GEE Micro pinzas para plegar alambre	741, 744	MINIMUS Manómetros para la presión de la sangre	24
MC GIVNEY Ligadores hemorroides	868	MINI-OLSEN Porta-agujas con tijeras	495
MC GLAMRY Periostótomos	1068	MINI-ROUX Separadores	417
MC INDOE Osteótomos	684	MINI-TOWNSEND Pinzas saca-bocados para biopsia	922
MC INDOE Pinzas de disección	199	Mini-Transformador	27
MC INDOE Pinzas quirúrgicas	211	MINI-VANNAS Micro-tijeras	138
MC INDOE Separadores	443	Miringotomo	735
MC INDOE TC Pinzas de disección	232	MISKIOM Separadores, autoestáticos	454
MC INDOE Tijeras para cartílago	115	MIXTER Pinzas de disección y ligaduras	268, 280
MC INTOSH Laringoscopios	38	MIXTER Pinzas para los cálculos biliares	878
MC INTOSH Laringoscopios de luz fría	40	MIXTER Tijeras para cirugía	97
MC IVOR Abajalenguas	616	MIXTER-O'SHAUGNESSY Pinzas de disección y ligaduras	281
MC IVOR Abrebocas	614	MOCK Aguja para heparin	73
MC KENTY Elevadores para tabique nasal	676, 677	MOELTGENGONIómetro	20
MC KENZIE Grapas de plata	546	MOLDENHAUER Elevador auricular	730
MC KENZIE Pinzas aplicadoras para agrafes	547	MOLDESTAD Separadores	433
MC KENZIE Porta-rapas	546	MOLLISON Separadores, autoestáticos	447
MC KESSON Tornillo oral	619	MOLT Abrebocas	603
MC QUIGG-MIXTER Pinzas vasculares atraumáticas	300	MOLT Periostótomos	1054
MEAD Martillos	1013	Mondador de tendónes	1152, 1153
MEAD Pinzas-gubias	1130	MOORE Cucharilla para la vesícula biliar	873
Measuring tape	21	MOORE Perforadores de mano	1171
Meatótomo	948	MOORFIELD Pinza para sutura	198
MEEKER Pinzas de disección y ligaduras	266	MORGAN Proctoscopios	864
MEMORY Espátulas cerebrales	544	MORITZ-SCHMIDT Abajalenguas	601
MENGHINI Aguja para la punción ciega del hígado	74	MORRIS Separadores	401
MERCEDES Separadores costales	790	MORRIS-DE BAKEY Pinzas vasculares atraumáticas	324
METZENBAUM Porta-agujas	489	MORSE Separadores costales	775, 778, 779
METZENBAUM SCT Tijeras des disección	187, 188	MORSE-FAVALORO Separadores costales	778
METZENBAUM TC Tijeras des disección	167-170	MOSHER-BRUENINGS Tubo del intubation	653
METZENBAUM TC Tijeras para ligatures	181	MOSQUITO-DANDY Pinzas haemostaticas	248
METZENBAUM Tijeras des disección	108-111, 154	MOYNIHAN Pinzas-Clamps para histerectomia	273
METZENBAUM-BABY Tijeras des disección	111, 155	MOYNIHAN Sondas exploradoras para cálculos biliares	872
METZENBAUM-LAHEY TC Tijeras des disección	173	MUCK Cuchillo para peristio	735
MEYER Pinzas para reducción	1116	MUEHLING Periostótomos	562
MEYERDING Separadores	407, 441, 486	MUELLER Pinzas para anastomosis de recto	858
MEYERDING Separadores, autoestáticos	452	MUELLER Separadores, autoestáticos	445
MICHEL Agrafes de sutura	516	MUENCHEN Curetas para biopsia	913
MICHEL Espejos para rinoscopia	632	MURPHY Cinta de celuloide	35
MICHEL Pinzas aplicadoras para agrafes	517	MURPHY-LANE Elevador para luxación	1083
MICK Tijeras para vendajes y Cizallas para escayolas	633, 1108	MUSEUX Pinzas para coger el cuello de útero	905, 906, 908
Micro agujas	748, 749, 752, 753	MUSGROVE Aguja de cerumen y aplicadores de algodón	730
Micro cuchillos	745	MYLES Pinzas nasales	990
Micro disecador	814	<b>N</b>	
Micro ganditos	749	NABATOFF Juego para varices	806
Micro instrumentos	745-753	NAEGELE Forceps obstérico	932
Micro pinzas	226-228	NAGER Separador para velo del paladar	627
Micro pinzas auriculares	739, 743	Navajas	58
Micro pinzas de copas	739, 743	NEFF Bisturíes para menisco	1146
Micro pinzas para plegar alambre	741, 742, 744	NEGUS (GUEDEL) Laringoscopios	36
Micro tijeras auriculares	740, 744	NEGUS Cuchillos para adenoides	629
MICRO-ADSON Pinzas haemostaticas	245	NEGUS Pinzas para pedículo renal	282
Microcirugía endolaríngeal	642-651	NEGUS Sopoite de pecho para todos los abrebocas	617
Microdisectomia lumbar separador Set	583	NEIVERT Gancho para alas de nariz	690
MICRO-MOSQUITO Pinzas haemostaticas	250, 259	NEIVERT Porta-agujas	491
Micro-pinza de agarre	642-643, 646, 649-651	NEIVERT-ANDERSON Osteótomos	683
Micro-pinza en forma de cucharilla	642, 647-651	NEIVERT-MASING TC Porta-agujas	524
Micro-porta-aguja	643, 644	NÉLATON Sondas acanaladas	63





NELSON Pinzas para agrrar pulmón	216	PAYR Sondas conductoras	512
NELSON Trócares	69	PEAN Pinzas haemostaticas	238-241
Neurocirugía	537-594	PECK-JOSEPH Tijeras finas para cirugía	123
NEW ORLEANS TC Porta-agujas	526	PEDERSON Espéculos vaginales	883, 884
NEWS Separadores para tráquea	656	PEERS-BERTRAM Pinzas de campo	369
NICOLA Cureta	704	PEET Pinzas para espinas	1208
NICOLA Legra	704	PELKMANN Pinzas para vendajes	355
NICOLA Micro-pinza en forma de cucharilla	651	PELTESON Porta-algodones	633
NICOLA Micro-tijeras de agarre	651	Pelvímetro	931
NIEDERDELLMANN Osteótomos	1038	PENFIELD Disecadores para duramadre	812
NISSEN Pinzas haemostaticas	243	PENNINGTON Elevadores para tabique nasal	676
NORFOLK & NORWICH Separadores, autoestáticos	453	PENNINGTON Pinzas intestinales y para tejidos	362
NOTO Pinzas para pólipos uterinos y ovarios	357	PENNYBACKER Pinzas cortantes para laminectomía	1004
NOTT Espéculos vaginales	883	PENNYBACKER Pinzas-gubias	1131
NOVAK Curetas para biopsia	912	PENNYBAKER Disecadores para duramadre	813
NOYES Micro-tijeras	140	PERCY Retractores para amputación	1008
NUBOER Tubos para aspiración	78	Perfora-cráneos	937
NUSSBAUM Pinzas-clamps intestinales	849	Perforadores	748
<b>O</b>		Perforadores de mano	1156, 1157, 1171-1173
O'BRIEN Tijeras finas para cirugía	128	Perforadores para aorta	811
OBWEGESER Agujas para ligaduras	501	Periostótomos	562, 563, 1052-1055, 1058-1071
OBWEGESER Elevadores	1056	PERKINS Separadores, autoestáticos	448
OBWEGESER Escofinas	1088	PERTHES Escariadores	1012
OBWEGESER Gancho de mentón	383, 1057	PESTALOZZA Cucharillas para aborta y placenta	942
OBWEGESER Osteótomos	1035, 1036	PETZ Pinzas-clamps intestinales y estomacales	860
OBWEGESER Osteótomos de cuña	1035	PHANEUF Pinzas-Clamps para histerectomía	273
OBWEGESER Osteótomos de hoja	1035	Piedra afilador	58
OBWEGESER Osteótomos hendedores	1035	PIERCE Cánula para punción del seno maxilar	70
OBWEGESER Osteótomos interdentes	1036	PIERCE Elevadores para tabique nasal	676
OBWEGESER Periostótomos	1058, 1059	Pies de rey para	559
OBWEGESER Separador para muela del juicio	387	PINARD Estetoscopios fetales	17
OBWEGESER Separadores para el ramo	386	Pinzas de tracción craneal	548
OBWEGESER Separadores para partes blandes	384, 385	Pinzas de vena cava	347, 348
OBWEGESER Separadores mandibulares	1057	Pinza de fijacion	686
OCHSNER Pinzas de disección	203	Pinza de introducción de la lámina auricular	820
OCHSNER Pinzas vasculares atraumáticas	331	Pinza para abscesos de las amígdalas	623
OCHSNER Sondas exploradoras para cálculos biliares	873	Pinza para agrrar	204
OCHSNER Trócares para vesícula biliar	71	Pinza para cerrar clamps	860
OCHSNER-KOCHER Pinzas haemostaticas	252, 253	Pinza para cerrar los clamps	845
O'CONNOR Separadores	431	Pinza para coger la piel	686
OKONEK-YASARGIL Empujador de tumor	828	Pinza para columela	686
OLDBERG Pinzas cortantes para laminectomía	1005	Pinza para cuerpos extraños	731
OLIVECRONA Bisturíes para nervio trógemino	57	Pinza para fijar	946
OLIVECRONA Disecadores de dura-madré	550	Pinza para formar huesos	1118
OLIVECRONA Espátulas cerebrales	544	Pinza para huesos	1117-1125
OLIVECRONA Pinzas-gubias	1131	Pinza para introducir para prótesis de teflon	742
OLIVECRONA Sierras de hilo	1010	Pinza para pericráneo	936
OLIVECRONA Tijeras nasales	120	Pinza para poner los clamps bulldog	293, 296
OLIVECRONA-TOENNIS Pinzas aplicadoras para agrafes	547	Pinza para rotula	1117
OLLIER Separadores	380	Pinza para sutura	198
OLSEN-HEGAR Porta-agujas con tijeras	495	Pinza retractora para espéculos	702
OLSEN-HEGAR TC Porta-agujas	527	Pinza-clamp para músculos	657
OMBREDANNE Martillos	1015	Pinza-clamp uterina	936
Orinal	1216	Pinza-guía para taladros	1012
O'SHAUGNESSY Pinzas de disección y ligaduras	281	Pinzas	194-229
Osteótomos	680-684, 1021, 1026-1051	Pinzas aplicadoras para agrafes	517, 518
Osteótomos de cuña	1035	Pinzas atrauma	218-220
Osteótomos de hoja	1035	Pinzas auriculares	732-734
Osteótomos hendedores	1035	Pinzas auriculares y nasales	221, 222
Osteótomos interdentes	1036	Pinzas bronquiales	802
O'SULLIVAN - O'CONNOR Espéculos vaginales	895	Pinzas capsulares	955
O'SULLIVAN-O'CONNOR Separadores abdominales	476	Pinzas con bocas de carburo tungsteno	232-236
OTIS Uretrótomo	954	Pinzas cortantes circulares	756
Otoscopios	599, 712	Pinzas cortantes para huesos	1141-1144
OVERHOLT Pinzas de disección y ligaduras	261, 262	Pinzas cortantes para laminectomía	958-978, 984, 985, 979-987, 994-1007
OVERHOLT-GEISSENDOERFER Pinzas de disección y ligaduras	260	Pinzas cortantes para laminectomía, desmontable	962, 966
OVERHOLT-MIXTER Pinzas de disección y ligaduras	268	Pinzas de campo	367-369
<b>P</b>		Pinzas de disección	194-204
PACHON Manómetros para la presión de la sangre	24	Pinzas de disección y ligaduras	260-270, 280-281
PAPAVERO-CASPAR Espéculos para hipofí sectomía	702	Pinzas de relojero	228
PARKER Separadores	417	Pinzas depilatorias	223
PARKER-BABY Separadores	417	Pinzas garrapata	226
PARKER-KERR Pinzas para anastomosis de recto	855	Pinzas haemostaticas	238-260
PARKER-LANGENBECK Separadores	418	Pinzas intestinales y para tejidos	360-366
PARKER-MOTT Separadores	418	Pinzas nasales	756-760, 988-994
PARKS Escofi nas nasales	1087	Pinzas nasales para biopsia	755
PARTSCH Cinceles	1027	Pinzas naso-faringeas	631
PARTSCH Gubias	1028	Pinzas para aborta y placenta	939-941
PARTSCH Martillos	1017	Pinzas para agrrar pulmón	216
PARTSCH-LANGE Periostótomos	1052	Pinzas para agrrar tejidos	203, 204, 209, 217
PASSOW Pisón	1024	Pinzas para amígdalas	620
PAUL Separadores	444	Pinzas para anastomosis de recto	855-859

Pinzas para biopsia rectal	869	Porta-agujas con bocas de carburo tungsteno	520-535
Pinzas para Broncho-esofagoscopia	636	Porta-agujas con tijeras	495
Pinzas para cálculos	945	Porta-algodones	65, 66, 633, 653
Pinzas para coger el cuello de útero	901-908	Porta-clamp	845
Pinzas para coger el pulmón	801	Porta-hojas	47
Pinzas para cortar uñas	1205, 1206	Porta-rapas	546
Pinzas para cuerpos extraños	948	Portas ligaduras	815, 822
Pinzas para desechos	1218	<b>POTTS</b> Pinzas vasculares atraumáticas	307, 308, 315, 319, 320
Pinzas para el maleolo	1117	<b>POTTS-DE MARTEL</b> SCT Tijeras vasculares	192
Pinzas para el seno frontal	695	<b>POTTS-DE MARTEL</b> Tijeras vasculares	136
Pinzas para el útero	909, 910	<b>POTTS-SMITH</b> Pinzas de disección	201
Pinzas para el vómer	696, 697	<b>POTTS-SMITH</b> Pinzas quirúrgicas	213
Pinzas para entrelazar tendones	1150-1152	<b>POTTS-SMITH</b> TC Pinzas de disección	233
Pinzas para espinas	224-225, 1208	<b>POTTS-SMITH</b> TC Tijeras vasculares	179
Pinzas para esterilización	1209	<b>POTTS-SMITH</b> Tijeras vasculares	117, 133, 136, 158
Pinzas para etmoides	745	<b>POZZI</b> Pinzas para coger el cuello de útero	902
Pinzas para extraer alambres	1159-1163	<b>PRATT</b> Curetas para el seno maxilar	690
Pinzas para introducir catéteres	944	<b>PRATT</b> Pinzas para coger el cuello de útero	907
Pinzas para iridectomía	197, 208	<b>PRATT</b> Pinzas para peritoneo	277
Pinzas para los cálculos biliares	877, 878	<b>PRATT</b> Separadores para el recto	861
Pinzas para los cálculos renales	875	<b>PRATT</b> Sondas	64
Pinzas para menisco y cartilago	1145, 1146	<b>PRECISA</b> Manómetros para la presión de la sangre	24
Pinzas para nefrostomía	874, 876	<b>PRINCE</b> Tijeras para amígdalas	116
Pinzas para pasar tendones	1150-1152	<b>PRINCE-THOMAS</b> Pinzas bronquiales	802
Pinzas para pediculo renal	282-284	<b>PRINCE-THOMAS</b> Pinzas para coger el pulmón	801
Pinzas para peritoneo	277-279	Proctoscopios	862, 864
Pinzas para pólipos auriculares	732	Protección del dedo	619
Pinzas para pólipos laríngeos	634, 635	<b>PROVIDENCE-HOSPITAL</b> Pinzas haemostaticas	249
Pinzas para pólipos uterinos y ovarios	356, 357	Pulverizadores	718
Pinzas para poner agrafes ETHICON	518	Puntas de prueba rectales	866
Pinzas para reducción	1115	<b>PUTTI</b> Escofinas	1089
Pinzas para sacar órganos	358	<b>Q</b>	
Pinzas para secuestro	1118	<b>QUATTRO</b> Separadores para escayolas	1194
Pinzas para sujetar y romper hojas de afeitar	825	<b>QUERVAIN</b> Elevadores	1074
Pinzas para tabique nasal	696-699, 701	<b>QUINBY</b> Tijera para encías	124
Pinzas para tamponamiento y pólipos nasales	669, 670	<b>QUINKE</b> Agujas para la punción ciega del hígado	74
Pinzas para tampones	353, 359, 349-352, 354, 355	<b>QUIRE</b> Elevador para cuerpos extraños	731
Pinzas para tubos	370-371	Quita hojas	48
Pinzas para uréter	945	<b>R</b>	
Pinzas para vasos y tumores	214, 216, 218	<b>RABINER</b> Martillo para reflejos	17
Pinzas para vendajes	349-352, 354, 355	Rack para instrumentos Rhoton	839
Pinzas porta-huesos	1126	<b>RADOLF</b> Pinzas para cortar uñas	1206
Pinzas porta-laminillas	226	<b>RAGNELL</b> Separadores	419
Pinzas quirúrgicas	205-218	<b>RAGNELL-DAVIS</b> Separadores	440
Pinzas saca-bocado	742, 744	<b>RAKE</b> Separadores	486
Pinzas saca-bocado craneal	549	<b>RALK</b> Perforadores de mano	1172, 1173
Pinzas saca-bocados para biopsia	916-923	<b>RALK</b> Pinzas para espinas	1208
Pinzas saca-bocados para el seno maxilar	693-695	<b>RAMPLEY</b> Pinzas para tampones	359
Pinzas tira-lengua	618	<b>RANDALL</b> Curetas para biopsia	912
Pinzas vasculares atraumáticas	299-346	<b>RANDALL</b> Pinzas para los cálculos renales	875
Pinzas vasculares para recién nacidos	298-299	<b>RANDALL</b> Pinzas para nefrostomía	876
Pinzas-clamps anastomosis	845	<b>RANEY</b> Pinza haemostática para cuero cabelludo	546
Pinzas-clamps estomacales	851	<b>RANEY</b> Pinzas aplicadoras para agrafes	546
Pinzas-clamps intestinales	844-854	Rascador para lupus	60
Pinzas-clamps intestinales y estomacales	860	Raspador	748
Pinzas-Clamps para histerectomía	271-276, 286	<b>RAY</b> Cureta	703
Pinzas-gubias	1126-1140	<b>RECAMIER</b> Curetas uterinas	925, 926, 928
Pinze de sugestión para bocio	657	Recipientes	1212-1217
<b>PIPER</b> Forceps obstétrico	934	<b>REDON</b> Agujas de guía	66-68
Pisón	1024	Regla de la sutura	823
Pistola-lavatoria de chorro de agua	1226	Reglas	22
<b>PITHA</b> Pinzas para vendajes	352	<b>REICHERT</b> Depresor para epiglotis	633
<b>PITHA</b> Tornillo oral	619	<b>REILL</b> Alicates corta-alambres	1164
Placa para extender la piel	59	<b>REILL</b> Pinzas para reducción	1116
<b>PLESTER</b> Cuchillo en forma de hoz	745	<b>REINER</b> Cuchillos para escayolas	1195
<b>PLESTER</b> Cuchillo para lóbulos	745	<b>RESANO</b> Pinzas para anastomosis de recto	859
<b>PLESTER</b> Excavador	747	<b>RESANO</b> Tijeras de cápsula	105
<b>PLESTER</b> Ganchito	747	Retractores de huesos y articulaciones	1184
<b>PLESTER</b> Ganchito para el seno maxilar	747, 748	Retractores epicárdicos	817
<b>PLESTER</b> Horquilla	747	Retractores para amputación	1008
<b>PLESTER</b> Raspador	748	Retractores vasculares	827
<b>PLESTER</b> Separadores, autoestáticos	448	<b>REVERDIN</b> Agujas para ligaduras	500
<b>PLESTER</b> Tubos para aspiración	77	<b>REVERDIN</b> Espátulas abdominales e intestinales	421
Polipótomos	671	<b>REYNOLDS</b> SCT Tijeras des disección	189
Polipótomos auriculares	738	<b>REYNOLDS</b> TC Tijeras des disección	172, 173
<b>POLITZER</b> Agujas para paracentesis	736	<b>REYNOLDS</b> Tijeras des disección	114, 156
<b>POLITZER</b> Cuchillo para furúnculo	735	<b>RHOTON</b> Aguja	841
<b>POLITZER</b> Espéculos auriculares	721	<b>RHOTON</b> Cucharilla	840, 841
<b>POLITZER</b> Insufladores de aire	716, 717	<b>RHOTON</b> Disecador	840
<b>POLLOSON</b> Separadores	410	<b>RHOTON</b> Disector esférico	840
<b>POOLE</b> Tubos para aspiración	82, 83	<b>RHOTON</b> Elevadores	840
<b>POPLITEA</b> Separadores abdominales	465	<b>RHOTON</b> Gancho	841
Porta-agujas	488-499	<b>RIBBON-IRIS</b> Tijeras finas para cirugía	130



<b>RIBBON-STEVENS</b> Tijeras finas para cirugía	130	<b>SCALP-CONTOUR</b> Separadores, autoestáticos	446
<b>RICARD</b> Separadores abdominales	468	<b>SCHAEDEL</b> Pinzas de campo	368
<b>RICHARDSON</b> Separadores	412	<b>SCHAMBERG</b> Extractore para comedones	61
<b>RICHARDSON-EASTMAN</b> Separadores	411	<b>SCHEDE</b> Cucharillas cortantes	1095
<b>RICHNAU-HOLMGREN</b> Espéculos auriculares	726	<b>SCHEIBE</b> Pinzas intestinales y para tejidos	362
<b>RICHTER</b> Tijeras para cirugía	97	<b>SCH EINMANN</b> Pinzas para Broncho-esofagoscopia	637
<b>RICHTER-HEATH</b> Pinzas aplicadoras para agrafes	518	<b>SCHERBACK</b> Espéculos vaginales	894
<b>RIENHOFF</b> Separadores costales	782	<b>SCHIMMELBUSCH</b> Tambores para esterilización	1224
<b>RIGBY</b> Separadores, autoestáticos	458	<b>SCHINDLER</b> Pinzas para peritoneo	279
<b>RING</b> Abajalenguas	616	<b>SCHINK</b> Dermátomos	59
Riñoneras	1212	<b>SCHINK</b> Placa para extender la piel	59
<b>RI-RAP</b> Estetoscopios	19	<b>SCHIOETZ</b> Tonómetros	23
<b>RITTER</b> Dilatadores para el seno frontal	753	<b>SCHLESINGER</b> Pinzas cortantes para laminectomía	1006
<b>ROBB</b> Disecadores vasculares	814	<b>SCHMEDEN</b> Pinzas nasales	992
<b>ROBERTS</b> Pinzas de disección y ligaduras	269	<b>SCHMID</b> Cánulas para irrigación vascular	73
<b>ROBIN MASSE</b> Separadores abdominales	465	<b>SCHMID</b> Espátula para íntima	813
<b>ROBIN</b> Pinzas de campo	367	<b>SCHMIEDEN</b> Agujas para ligaduras	502
<b>ROCHARD</b> Separadores abdominales	477	<b>SCHMIEDEN</b> Sondas conductoras	511
<b>ROCHESTER-CARMALT</b> Pinzas haemostaticas	245	<b>SCHMIEDEN-DICK</b> Agujas para ligaduras	501
<b>ROEDER</b> Cierra-nudos para amígdalas	627	<b>SCHMIEDEN-PAYR</b> Sondas conductoras	511
<b>ROEDER</b> Pinzas de campo	368	<b>SCHMIEDEN-TAYLOR</b> Tijeras vasculares	133
<b>ROETTGEN-RUSKIN</b> Pinzas-gubias	1134	<b>SCHNEIDER</b> Periostótomos	1064
<b>ROGER</b> Elevadores para tabique nasal	676	<b>SCHNEIDER-SAUERBRUCH</b> Periostótomos	1065
<b>ROGERS</b> Pinzas-Clamps para histerectomía	275, 276	<b>SCHNIDT</b> Pinzas haemostaticas	244
<b>ROGGE</b> Pinzas para esterilización	1209	<b>SCHNIDT</b> Pinzas para amígdalas	620
<b>ROLLET</b> Separadores	432	<b>SCHOEMAKER</b> Pinzas-clamps intestinales	852
Rompe-hojas de afeitar	47	<b>SCHOEMAKER-LOTH</b> Tijeras para ligatures	147
<b>ROSCHKE</b> Separadores para el recto	864	<b>SCHOENBORN</b> Separadores para tráquea	656
<b>ROSE</b> Separadores	419	<b>SCHROEDER</b> Bisturíes para fistulas	56
<b>ROSEN</b> Cucharilla	747	<b>SCHROEDER</b> Cucharillas uterinas	924
<b>ROSEN</b> Cuchillo lanceolado	747	<b>SCHROEDER</b> Pinzas para coger el cuello de útero	901, 903, 907
<b>ROSEN</b> Cuchillos para cortes redondos	746	<b>SCHUBERT</b> Pinzas saca-bocados para biopsia	916, 917
<b>ROSEN</b> Gancho	747	<b>SCHUHKN ECHT</b> Aparato de doblar para moldear prótesis metálicas	686
<b>ROSEN</b> Micro aguja	748, 749	<b>SCHUHKN ECHT</b> Tubos para aspiración	89
<b>ROSEN</b> Periostótomo	747	<b>SCHUHKN ECHT</b> Cuchillo en forma de hoz	746
<b>ROSEN</b> Tubos para aspiración	85	<b>SCHUHKN ECHT</b> Cuchillo en forma de rollo	746
<b>ROSER-KOENIG</b> Abre bocas	604	<b>SCHUHKN ECHT</b> Micro pinzas para plegar alambre	741
<b>ROSS</b> Separadores para aorta	816	<b>SCHUL</b> Separadores para disco intervertebral	594
<b>ROUX</b> Separadores	416	<b>SCHULTZE</b> Salpingógrafo	915
<b>ROUX-MAGNUS</b> Separadores	417	<b>SCHUMACHER</b> Costótomos	764
<b>RUBIN</b> Osteótomos	681	<b>SCHUMACHER</b> Pinzas para Broncho-esofagoscopia	637
<b>RUBIN</b> Pinzas para tabique nasal	701	<b>SCHUMACHER</b> Pinzas saca-bocados para biopsia	920
<b>RUDD</b> Ligadores hemorroides	867	<b>SCHUMACHER</b> Tijera umbilicales	102
<b>RUMEL</b> Pinzas de disección y ligaduras	267	<b>SCHUMACHER-VAN DOREN</b> Pinzas saca-bocados para biopsia	918
<b>RUMEL-BELMONT</b> Instrumentos para varices	815	<b>SCHWEDEN</b> Cucharillas cortantes	1091
<b>RUMEL-BELMONT</b> Portas ligatures	815	<b>SCOVILLE</b> Cucharillas cortantes	1106
<b>RUSKIN</b> Cánula para punción del seno maxilar	87	<b>SCOVILLE</b> Separadores	486
<b>RUSKIN</b> Pinzas-gubias	1133	<b>SCOVILLE</b> Separadores para la raíz de nervios	552
<b>RUSKIN-LISTON</b> Pinzas cortantes para huesos	1142	<b>SCOVILLE</b> Separadores para laminectomía	558
<b>RUSSEL-DAVIS</b> Abajalenguas	615	<b>SCOVILLE</b> Valvas laterales	557, 558
<b>RUSSIAN</b> Pinzas para agrar tejidos	203	<b>SCOVILLE-HAVERFIELD</b> Separadores para laminectomía	557
<b>RUST</b> Sierras para amputación y resección	1009	<b>SCOVILLE-RICHTER</b> Separadores para laminectomía	556
<b>RYDEL-SEIFFER</b> Diapasónes	713	<b>SCOVILLE-RICHTER</b> Valvas laterales	565
<b>RYDER</b> Porta-agujas	498	<b>SCT</b> Tijeras des disección	187
<b>RYDER-VASCULAR TC</b> Porta-agujas	532	<b>SCT</b> Tijeras finas para cirugía	190
<b>S</b>		<b>SCT</b> Tijeras nasales	189, 190
<b>SAALFELD</b> Extractore para comedones	61	<b>SCT</b> Tijeras para cirugía	186, 187
<b>SACHS</b> Disecadores de dura-madré	550, 551	<b>SCT</b> Tijeras para Face-lift	190
<b>SACHS</b> Ganchos para dura-madré	554	<b>SCT</b> Tijeras uterinas	186
<b>SACHSE</b> Meatótomo	948	<b>SCT</b> Tijeras vasculares	191
<b>SAENGER</b> Pinzas para aborta y placenta	941	<b>SCUDDER</b> Pinzas-clamps estomacales	851
<b>SALENIUS</b> Bisturíes para menisco	1146	<b>SEBILÉAU</b> Elevadores	1074
Salpingógrafo	915	<b>SEDILLOT</b> Periostótomos	1063
<b>SALYER</b> Tijeras para Face-lift	118	<b>SEEMANN-SEIFERT</b> Abrebocas	605
<b>SAMII</b> Bisturí de lanceta	837	<b>SEGOND</b> Bisturí para fibroma	56
<b>SAMII</b> Cuchillo del tumor	836, 837	<b>SEGOND-LANDAU</b> Pinzas-Clamps para histerectomía	273
<b>SANTULLI</b> Clamps Bulldog	296	<b>SEIDL</b> Espéculos vaginales	887
<b>SANVENERO</b> Tijeras finas para cirugía	124	<b>SEIFFERT</b> Pinzas para Broncho-esofagoscopia	637
<b>SAROT</b> Pinzas de disección y ligaduras	267	<b>SELDIN</b> Periostótomos	1064
<b>SAROT</b> Porta-agujas	490	<b>SELLHEIM</b> Seperador obstétrica	936
<b>SAROT TC</b> Porta-agujas	524	<b>SELLORS</b> Aproximadores para costillas	800
<b>SATINSKY</b> Pinzas de vena cava	347, 348	<b>SELMANN</b> Pinza para agrar	204
<b>SATINSKY</b> Pinzas vasculares atraumáticas	332	<b>SELVERSTONE</b> Pinzas cortantes para laminectomía	998, 999
<b>SATINSKY</b> Tijeras vasculares	131	<b>SEMB</b> Periostótomos	1066
<b>SATTERLEE</b> Sierras para amputación y resección	1010	<b>SEMB</b> Pinza para huesos	1119
<b>SAUERBRUCH</b> Costótomos	765	<b>SEMB</b> Pinzas bronquiales	802
<b>SAUERBRUCH</b> Estuches para agujas	1223	<b>SEMB</b> Pinzas cortantes para huesos	1144
<b>SAUERBRUCH</b> Pinzas para desechos	1218	<b>SEMB</b> Pinzas-gubias	1139
<b>SAUERBRUCH</b> Separadores	382, 394	<b>SEMKEN</b> Pinzas de disección	199, 200
<b>SAUERBRUCH-CORYLLOS</b> Pinzas-gubias	1140	<b>SEMKEN</b> Pinzas quirúrgicas	208, 212
<b>SAUERBRUCH-FREY</b> Costótomos	767	<b>SEMKEN TC</b> Pinzas de disección	232
<b>SAUNDERS</b> Instrumento para remoer dispositivo tintrauterino	911	<b>SEMKEN TC</b> Pinzas quirúrgicas	234, 235
<b>SAWTELL</b> Pinzas para amígdalas	620	<b>SEMM</b> Espéculos vaginales	882

<b>SEMM</b> Separadores abdominales	474	<b>SLUDER-BALLENGER</b> Amigdalotomos	625
<b>SENN-GREEN</b> Separadores	438	<b>SMELLIE</b> Ganchos para decapitación	937
<b>SENNING</b> TC Porta-agujas	523	<b>SMELLIE</b> Perfora-cráneos	937
<b>SENN-MILLER</b> Separadores	439	<b>SMILLIE</b> Bisturíes para menisco	1147
Separador de vulva	896	<b>SMILLIE</b> Separadores para rodilla	1148
Separador para dedos	1183	<b>SMITH</b> TC Cizallas corta-alambres	180
Separador para muela del juicio	387	<b>SMITH</b> Tijeras para vendajes	1186
Separador para velo del paladar	627	<b>SMITH-BUIE</b> Separadores para el recto	864
Separadores	374-486	<b>SMITH-PETERSEN</b> Gubias	1040
Separadores abdominales	465-477	<b>SMITH-PETERSEN</b> Osteótomos	1039
Separadores costales	769-799	<b>SMITH-PETERSEN</b> Pinzas-gubias	1134
Separadores costales de Aluminio	769-776	<b>SMITHWICK</b> Ganchos para dura-madré	554
Separadores mamaria	794-797	<b>SNELLEN</b> Asas auriculares	728
Separadores nasales	687-690	<b>SOMER</b> Pinzas para el útero	909
Separadores para aorta	816, 817	Sonda abotonada	827, 828
Separadores para atrio	816, 824	Sonda de mirto	62
Separadores para cuerpos vertebrales	592, 593	Sonda doble	827
Separadores para el ramo	386	Sonda para bocio	657
Separadores para escayolas	1193, 1194	Sonda para medir	748
Separadores para la cirugía lumbar vertebral	582-585	Sondas	62-64
Separadores para la columna cervical	568-581	Sondas abotonadas	62
Separadores para la fijación del cráneo	540-542	Sondas acanaladas	63
Separadores para la raíz de nervios	551-553	Sondas auriculares	716
Separadores para la vejiga	952	Sondas conductoras	509-513
Separadores para labios y mejillas	618	Sondas exploradoras para cálculos biliares	872, 873
Separadores para laminectomía	556-559	Sondas metálicas	951
Separadores para mamoplastia	422	Soporte de pecho	638
Separadores para mejillas	619	Soporte de pecho para todos los abre bocas	617
Separadores para partes blandes	384, 385	Soporte para esterilizar las agujas de suture	1223
Separadores para rodilla	1148, 1149	Soportes de valve auriculares	820
Separadores, autoestáticos	445-464	<b>SPENCER-WELLS</b> Pinzas haemostaticas	242
Seperador obstétrica	936	<b>SPRATT</b> Cucharillas cortantes	1097
Seperador para el borde anterior	1057	<b>SPREADY</b> Separadores para laminectomia	589-591
Seperador para el cuerpo mandibular	1057	<b>SPURLING</b> Pinzas cortantes para laminectomía	997
Seperadores mandibulares	1057	<b>ST. CLAIR-THOMSON</b> Cuchillos para adenoides	629
Seperadores para disco intervertebral	594	<b>ST. MARKS</b> Separadores	420
Separadores para el recto	861, 864-866	<b>ST. MARKS</b> Separadores para el recto	866
Seperadores para la prostata	953	<b>STACKE</b> Sondas abotonadas	62
Seperadores para laminectomia	564-567, 586-591	<b>STANDARD</b> Trócares	69
Seperadores para tráquea	655	<b>STAUDE-MOORE</b> Pinzas para coger el cuello de útero	901
<b>SEUTIN</b> Tijeras para vendajes y Cizallas para escayolas	1191	<b>STEINBACH</b> Martillos	1018
<b>SEWALL</b> Periostótomos	1052, 1060	<b>STELLA</b> TC Tijeras para Face-lift	175
<b>SEXTON</b> Agujas para paracentesis	735	<b>STELLBRINK</b> Pinzas-gubias	1127
<b>SEYFFERT</b> Espéculos vaginales	882	<b>STELZNER</b> Tijeras rectales	107
<b>SHAAF</b> Pinzas depilatorias	223	<b>STERNBERG</b> Separadores para labios y mejillas	618
<b>SHAMBAUGH</b> Micro ganchitos	749	<b>STEVENS</b> Pinzas para iridectomía	197, 208
<b>SHAMBOUGH</b> Adenótomos	630	<b>STEVENS</b> SCT Tijeras finas para cirugía	191
<b>SHAPLEIGH</b> Asas auriculares	729	<b>STEVENS</b> Tijeras finas para cirugía	127, 156
<b>SHEA</b> Cucharilla cortantes	751	<b>STIEGLITZ</b> Pinzas para espinas	1208
<b>SHEEHAN</b> Osteótomos	682	<b>STILLE</b> Cinceles	1032
<b>SIEGLE</b> Lupas auriculares	726	<b>STILLE</b> Cizallas para escayolas	1192
Sierra para escayolas	1195	<b>STILLE</b> Gubias	1033
Sierras de hilo	1010	<b>STILLE</b> Osteótomos	1032
Sierras eléctrica oscilante para autopsia	1022, 1023	<b>STILLE</b> Perforadores de mano	1171
Sierras eléctrica oscilante para yeso	1196-1199	<b>STILLE</b> Pinzas de disección	197
Sierras nasales	685	<b>STILLE</b> Pinzas para los cálculos biliares	878
Sierras para abrir anillos	1011	<b>STILLE</b> Pinzas para pedículo renal	283, 285
Sierras para amputación y resección	1009, 1010	<b>STILLE</b> Pinzas quirúrgicas	207
<b>SILVER</b> Dermátomos	59	<b>STILLE</b> Pinzas-gubias	1136
<b>SILVER</b> Osteótomos	683	<b>STILLE-BARRAYA</b> Pinzas para vasos y tumores	216
<b>SIMON</b> Bisturíes para fístulas	56	<b>STILLE-RUSKIN</b> Pinzas-gubias	1138
<b>SIMON</b> Cucharillas cortantes	1100	<b>STILLE-SHERMAN</b> Perforadores de mano	1171
<b>SIMON</b> Separadores	415, 436	Stilletas	1215
<b>SIMPLEX</b> Separadores para mejillas	619	<b>STOCKMANN</b> Compresoers urétral	946
<b>SIMPSON</b> Forceps obstétrico	932, 933	<b>STOCKMANN</b> Pinza para fijar	946
<b>SIMPSON-LUIKART</b> Forceps obstétrico	934	<b>STONE</b> Pinzas quirúrgicas	218
<b>SIMS</b> Curetas uterinas	900, 927, 930	<b>STONE-WATT</b> Pinza para cerrar clamps	860
<b>SIMS</b> Depresores uterinos	900	<b>STONE-WATT</b> Pinzas-clamps intestinales y estomacales	860
<b>SIMS</b> Espéculos para el recto	862	<b>STRABISMUS</b> Tijeras des disección	112
<b>SIMS</b> Espéculos vaginales	887	<b>STRANDELL-STILLE</b> Separadores	441
<b>SIMS</b> Hosterómetros	899	<b>STRASSBURG</b> Pinzas quirúrgicas	212
<b>SIMS</b> SCT Tijeras uterinas	186	<b>STRATTE</b> Porta-agujas	492
<b>SIMS</b> Seperadores para el recto	861	<b>STRATTE</b> TC Porta-agujas	526
<b>SIMS</b> TC Tijeras uterinas	163, 164	<b>STRAUSS</b> Compresoers urétral	946
<b>SIMS</b> Tijeras uterinas	98, 99, 151	<b>STRONG (COBRA)</b> Pinzas vasculares atraumáticas	318
<b>SIMS-BODENHAMMER</b> Seperadores para el recto	861	<b>STRUCK</b> Separadores costales	782
<b>SIMS-MAIER</b> Pinzas para vendajes	355	<b>STRUEMPPEL</b> Pinzas auriculares	734
<b>SIMS-SIEBOLD</b> Tijeras uterinas	100, 152	<b>STRULLY</b> Tijeras vasculares	131
<b>SINGLEY-TUTTLE</b> Pinzas para agrarr tejidos	204	<b>STRUYKEN</b> Pinzas nasales	990
Sinuscopios	599, 712	<b>SUBRAMANIAN</b> Pinzas vasculares atraumáticas	299
Sistema brazo	478, 479	Sujetador de mano	1182
Sistema distractor para el cuerpo vertebral cervical	560, 561	Surtido para enfermeras	1207
<b>SKENE</b> Pinzas para coger el cuello de útero	903	<b>SWEDISH</b> Disecadores de dura-madré	550





SWEET Pinzas aplicadoras para agrafes	547
SYPERT Pinzas cortantes para laminectomía	985, 987
SYPERT Pinzas-gubias	1140
SYSTRUNK Tijeras para uñas	1204
<b>T</b>	
TABB Cuchillo para mucosa	745
TAKAHASHI Pinzas cortantes para laminectomía	994
TAKAHASHI Pinzas nasales	757
Taladro para uñas	1207
Tambores para esterilización	1224
Taponador	626
TARNIER Craneoclasto	938
TARNIER Forceps obstétrico	935
TAYLOR Martillo para reflejos	16
TAYLOR Pinzas de disección	200, 201
TAYLOR Pinzas quirúrgicas	212, 213
TAYLOR Separadores para rodilla	1148
TAYLOR Valvas laterales	558
TAYLOR-BROWN Pinzas quirúrgicas	216
TC Cizallas corta-alambres	180
TC Pinza para sutura	236
TC Tijeras des disección	167-173
TC Tijeras finas para cirugía	177, 178
TC Tijeras nasales	174
TC Tijeras para amígdalas	174
TC Tijeras para cirugía	162, 165, 167
TC Tijeras para encías	177, 178
TC Tijeras para episiotomía	162
TC Tijeras para Face-lift	175, 176
TC Tijeras para ginecología	162
TC Tijeras para histerectomía	166
TC Tijeras para ligatures	181
TC Tijeras para perineo	162
TC Tijeras uterinas	163, 164
TC Tijeras vasculares	179, 180
TEALE Pinzas para coger el cuello de útero	904
TERRIER Pinzas haemostaticas	259
TESSIER Osteótomos	1033, 1036, 1037
TESSIER Periostótomos	1058
TESSIER Pinza para formar huesos	1118
TESSIER Tijeras nasales	120
THILENIUS Pinza para abscesos de las amígdalas	623
THOMS-ALLIS Pinzas intestinales y para tejidos	364
THOMS-GAYLOR Pinzas saca-bocados para biopsia	919
THOMSON-WALKER Separadores para la vejiga	952
THOREK TC Tijeras des disección	171
THOREK Tijeras des disección	113
THUDICHUM Espéculos nasales	660
TIECK-HALLE Espéculos nasales	660, 661
Tijeras	91-148
Tijeras abdominales	97, 98
Tijeras con fi los de carburo tungsteno	160-181
Tijeras de cápsula	105
Tijeras des disección	108-115, 154-156
Tijeras enterótomos	103
Tijeras finas para cirugía	123-130, 156-157
Tijeras nasales	118-122, 156, 754
Tijeras para amígdalas	116, 117
Tijeras para cartilago	115, 116
Tijeras para cirugía	91-97, 103-105, 151-153
Tijeras para decapitcón	100
Tijeras para encías	124, 125
Tijeras para episiotomía	101, 102, 152
Tijeras para Face-lift	117
Tijeras para ginecología	98-102
Tijeras para la cirugía plástica	115
Tijeras para ligatures	146, 147
Tijeras para perineo	101, 102, 152
Tijeras para tabique nasal	700
Tijeras para uñas	1204
Tijeras para vendajes y Cizallas para escayolas	1186-1192
Tijeras rectales	106, 107
Tijeras SUPERCUT	150-158
Tijeras SUPERCUT NITRITO de TITANO	184-192
Tijeras umbilicales	102
Tijeras uterinas	98-100, 151, 152
Tijeras vasculares	115, 117, 131-137, 158
TILLEY Pinzas para tamponamiento y pólipos nasales	669
TILLEY-HENCKEL Pinzas nasales	989
Tirabuzóns para mioma	908
TISCHLER Pinzas saca-bocados para biopsia	917, 921
TISCHLER-KEVORKIAN Pinzas saca-bocados para biopsia	921
TISCHLER-MORGAN Pinzas saca-bocados para biopsia	921, 922

TOBOLD Abajalenguas	601
TOBOLD Pinzas para pólipos laríngeos	634
TOENNIS Bisturíes para dura-madré	57, 58
TOENNIS Espátula para íntima	814
TOENNIS Ganchos para dura-madré	555
TOENNIS Pinzas haemostaticas	243, 255
TOENNIS Porta-agujas	497
TOENNIS TC Porta-agujas	531
TOENNIS Tijeras des disección	114
TOENNIS-ADSON SCT Tijeras des disección	189
TOENNIS-ADSON TC Tijeras des disección	173
TOENNIS-ADSON Tijeras des disección	115
TOHOKU Pinzas de campo	369
Tonómetros	23
Torchio per cartilagine	686
Tornillo oral	619
Torniquete para producir	29
TOWNLEY Calibrador	22
TOYNEE Espéculos auriculares	725
Tractor adecuado	936
Transformador	27, 42-43
Traqueótomo	653
TRAUBE Martillo para reflejos	17
TRAUTMANN Cinceles	1029
TRAUTMANN Gubias	1029
TRAVERS Separadores, autoestáticos	456
TRELAT Espéculos vaginales	882
TRELAT Periostótomos	1053
Trépanos para piel	60, 61
TREVES Pinzas quirúrgicas	216
Trócares	69-71
Trócares para punción torácica	70
Trocares para sinusocopia	692
Trócares para vesicula biliar	71
TROELTSCH Pinzas auriculares y nasales	221
TROELTSCH-JALASVIRTA Pinzas auriculares y nasales	221
TROEMMER Martillo para reflejos	16
TROUSSEAU Dilatatore traqueales	654
TROUTMAN-CHRIS Porta-hojas	47
TROUTMAN-CHRIS Rompe-hojas de afeitar	47
TUBBS Dilatadores para aorta	810
Tubo de aspiración y coagulación	87
Tubo del intubation	653
Tubos para aspiración	77-89
TUEBINGEN Micro pinzas	227
TUEBINGEN Micro-tijeras	140
TUEBINGEN Pinzas para los cálculos biliares	878
TUEBINGEN Separadores	414
TUEBINGEN Separadores, autoestáticos	449
TUFFIER Pinzas intestinales y para tejidos	365
TUFFIER Separadores	403
TUFFIER Separadores costales	780
TURNBULL Pinzas para cortar uñas	1205
TYDING Cierra-nudos para amígdalas	624
TYDING-TIVNEN Pinzas para amígdalas	621
<b>U</b>	
UCKERMANN Porta-algodones	65
UCKERMANN Traqueótomo	653
UFFENORDE Cucharillas cortantes	1114
ULM Bolso de la emergencia	28
ULRICH Bisturíes para fístulas	56
ULRICH Pinza para huesos	1122
ULRICH Pinzas para tapones	349
UNIVERSAL Cizallas corta-alambres	148
UNIVERSAL Pinzas para esterilización	1209
UNIVERSAL TC Cizallas corta-alambres	180
UNIVERSAL Tijeras para vendajes y Cizallas para escayolas	1191
UNIVERSAL Trócares	69
UNNA Extractore para comedones	61
UNNA-VITAL Extractore para comedones	61
Uretrótomo	954
USA Cucharillas cortantes	1108, 1109
USA Pinzas de disección	196
USA Pinzas quirúrgicas	206
USA Separadores para escayolas	1194
USA Tijera umbilicales	102
<b>V</b>	
VALLEIX Hosterómetros	899
Valvas	565
Valve auriculares	820
VAN BUREN Bujias dilatadoras	950
VAN BUREN Pinzas para secuestro	1118
VAN DOREN Pinzas saca-bocados para biopsia	918, 919

VANNAS Micro-tijeras	140	WERTHEIM-CULLEN Pinzas-Clamps para histerectomía	276
VARADY Flebextractor	814	WEST Cinceles	1025
VARADY Flebodisecador	814	WEST Gubias	1025
VARADY Juego para varices	807	WESTCOTT Micro-tijeras	141
VARADY Micro disecador	814	WESTMACOTT Pinzas para tamponamiento y pólipos nasales	669
VASCULAR Porta-agujas	498	WHITE Pinzas para amígdalas	620
Vaso medicinal	1213, 1214	WHITEHEAD Abrebocas	604
Vaso-medidas	1213	WIEDER Abajalenguas	602
VEDDER Cierra-nudos para amígdalas	624	WIEN Espéculos nasales	662
VEIDENHEIMER Pinzas para anastomosis de recto	857	WIEN Escofina para el seno maxilar	693
VERBRUGGE Pinza para huesos	1124	WIEN MOD. Pinzas-Clamps para histerectomía	274
VERHOEVEN Tubos para aspiración	89	WIGMORE Cuchillos para escayolas	1195
VERRES Cánulas para insuflación	73	WIKSTROEM Pinzas de disección y ligaduras	269
VICKERS Disectores	1052	WILDER Estilete para el canal lacrimal	63
VICKERS Elevadores	1052	WILLET Pinza para pericráneo	936
VICKERS Perforadores de mano	1156	WILLET-MARTEL Pinzas intestinales y para tejidos	366
VICKERS Separador para dedos	1183	WILLIAMS Pinzas intestinales y para tejidos	360
VICKERS Separadores	428, 1183	WILLIAMS Separadores, autoestáticos	464
VICKERS Sujetador de mano	1182	WILLIGER Cucharillas cortantes	1094, 1096
VIDAL Rascador para lupus	60	WILLIGER Elevadores	1074
VIENNA Captador de hilos	513	WILLIGER Martillos	1016
Vígorimeter	21	WILLIGER Periostótomos	1053
VIRCHOW Cinel rompe-craneo	1021	WILLIGER Separadores	420
VIRCHOW Cuchillos para autopsia	54	WILMER-WALTER Tijeras nasales	122
VIRCHOW Cuchillos para cerebro	55	WILSON Pinzas para coger el cuello de útero	904
VOLKMANN Cucharillas cortantes	1092, 1096, 1104, 1105	WINTER Pinzas para aborta y placenta	939, 940
VOLKMANN Separadores	374, 378	WIS-FOREGGER Laringoscopios	39
VOLLMAR Cánulas para irrigación vascular	73	WITTNER Pinzas saca-bocados para biopsia	920
VOLLMAR Fleboextractores	808	WOLFF Curetas para lupus	60
VOLTOLINI Espéculos nasales	660	WOLFF Separadores para escayolas	1194
<b>W</b>		WOODSON Disecadores para duramadre	812
WACHENFELDT Pinzas aplicadoras para agrafes	517	WRIGLEY Forceps obstétrico	935
WAGENER Separadores	429	WUERZBURG Abajalenguas	616
WAGNER Elevadores para huesos	1076, 1080, 1081	WULLSTEIN Mango para aspiración	85
WAGNER Gubias	1049	WULLSTEIN Micro pinzas de copas	739
WAGNER Instrumentos de flexión	1170	WULLSTEIN Periostótomos	1054
WAGNER Martillos	1014	WULLSTEIN Separadores, autoestáticos	447
WAGNER Periostótomos	1070	WULLSTEIN Tubos para aspiración	77, 86
WAGNER Pinzas cortantes para laminectomía	985, 986	<b>Y</b>	
WAGNER TC Tijeras finas para cirugía	177	YANKAUER Tubos para aspiración	81, 82
WAGNER Tijeras finas para cirugía	125, 126	YASARGIL Cuchillos para vasos	838
WALB Cuchillos para órganos	55	YASARGIL Disecador	835
WALDMANN TC Tijeras para episiotomía	162	YASARGIL Gancho para galea	545
WALDMANN TCTijeras para perineo	162	YASARGIL Guía-ligadura	829
WALDMANN Tijeras para episiotomía	101, 152	YASARGIL Legra	835
WALDMANN Tijeras para perineo	101, 152	YASARGIL Pinzas cortantes para laminectomía	1005
WALLICH Curettes uterines	911	YASARGIL Tubos para aspiración	80
WALTER Cinceles	682	YASARGIL-NICOLA Micro-pinza de agarre	651
WALTER Ganchito para alas de nariz	688	YEOMANN Pinzas para biopsia rectal	869
WALTER Gubias	1033	YOUNG Pinzas tira-lengua	618
WALTER Osteotomos	682	YOUNG Seperadores para la prostata	953
WALTON Pinzas para biopsia rectal	869	YOUNG-HRYNTSCHAK Agujas para ligaduras	513
WALTON Sierras para abrir anillos	1011	<b>Z</b>	
WALTON-YANKAUER Tubos para aspiración	81	ZANDER Escariadores	1012
WANGENSTEEN Pinzas para agrarr tejidos	204	ZAUFAL Elevador auricular	730
WANGENSTEEN Porta-agujas	494	ZAUFAL-JANSEN Gnachitos auriculares	731
WANGENSTEEN TC Pinzas de disección	233	ZAUFAL-JANSEN Pinzas-gubias	1133
WANGENSTEEN TC Porta-agujas	527	ZENKER Pinzas de disección y ligaduras	262, 263
WARTENBERG Algesímetro	20	ZENKER Separadores	391
WARTENBERG Rueda con espinas	20	ZIEGLER Bisturíes para dura-madré	57
WASSMUND Separadores	380	ZIEGLER Espejo frontal	35
WATSON Dermátomos	59	ZIEGLER Pinzas depilatorias	223
WATSON-CHEYNE Disectores	1056	ZIELKE Gubias	1044
WATSON-JONES Elevadores para huesos	1076	ZOELLNER Cuchillo en forma de hoz	752
WATSON-WILLIAMS Pinzas nasales	993, 994	ZOELLNER Cuchillo lanceolado	752
WAUGH Pinzas quirúrgicas	206	ZOELLNER Cuchillos para cortes redondos	752
WEBER Estesiometro	20	ZOELLNER Espéculos auriculares	720
WEBER Pinzas vasculares atraumáticas	312	ZOELLNER Ganchito	752
WEBER-LOCH Asas auriculares	729, 730	ZOELLNER Horquilla	752
WEBSTER Porta-agujas	491	ZOELLNER Micro aguja	752
WEBSTER TC Porta-agujas	525	ZOELLNER Periostótomo	752
WECKER Micro-tijeras	139	ZOELLNER Tubos para aspiración	89
WEIL-BLAKESLEY Pinzas nasales	988, 989	Z-PARAMETRIUM Pinzas-Clamps para histerectomía	286
WEIL-BLAKESLEY Pinzas para etmoides	745		
WEISMAN Curetas auriculares	729		
WEISSBARTH Espéculos vaginales	895		
WEITLANER Separadores, autoestáticos	446, 447, 453, 454		
WEITLANER-BABY Separadores, autoestáticos	449		
WELLER Pinzas para menisco y cartilago	1145		
WERTHEIM Pinzas para anastomosis de recto	859		
WERTHEIM Pinzas-Clamps para histerectomía	271, 272		
WERTHEIM TC Tijeras para histerectomía	166		
WERTHEIM Tijeras uterinas	100		



<b>A</b>			
Abassalingua	601, 602, 615, 616	ASCH Cucchiaio secreto	911
Abasso epiglottide	633	ASH Pinze per setto nasale	698
ABRAHAM Bisturi per tonsille	57	AUFRICHT Divaricatori nasali	687
ABRAHAM Pinze per tonsille	621	AUFRICHT Forbici per la chirurgia plastica	115
Adenotomi	630	AUFRICHT Raspe nasali	1085, 1090
ADLERDYCE Elevatori	1055	Autofissatore per retrattori, per il supporto del craino	540-542
ADLERKREUTZ Pinza vascolare e per tumori	214	AUVARD Speculi vaginali	895
ADSON Divaricatori, autostatici	453, 455, 458-461	AYRE Bisturi per cono	56
ADSON Periostotomi	1059	<b>B</b>	
ADSON Pinze anatomiche per dissezione	198, 199	BABCOCK Pinze da presa per intestino e tessuti	362, 363
ADSON Pinze emostatiche	245, 256	BABINSKY Martelli percussori	17
ADSON Pinze guida sonda	1012	BABY-ADSON Pinze per preparazioni e legature	269
ADSON Pinze per chirurgia	209, 210	BABY-ALLIS Pinze da presa per intestino e tessuti	363
ADSON Pinze per ossa	1131	BABY-COLLIN Divaricatori addominali	466
ADSON Portaghi	489	BABY-CRILE Pinze emostatiche	248, 257
ADSON Puteruoli	1012	BABY-CRILE-WOOD TC Portaghi	523
ADSON TC Pinze anatomiche per dissezione	232	BABY-KOCHER Pinze intestinali	844
ADSON TC Pinze per chirurgia	234	BABY-MIKULICZ Pinze per peritoneo	277
ADSON Tubi aspirazione	78	BABY-MIXTER Pinze per preparazioni e legature	270
ADSON Uncini per dura-madre	554, 555	BABY-MOSQUITO Pinze emostatiche	251
ADSON-BIEMER-MICRO Pinze per chirurgia	211	BABY-OVERHOLT Pinze per preparazioni e legature	270
ADSON-BROWN Pinze per chirurgia	217	BABY-ROUX Divaricatori	416
ADSON-BROWN TC Pinze per chirurgia	235	BABY-SATINSKY Pinze per vena cava	347
ADSON-DE BAKEY Pinze atraumatiche	218	BABY-TISCHLER Pinze per la biopsia cervicale e da prelievo	921
ADSON-GRAEFE Pinze per chirurgia	217	BABY-YANKAUER Tubi aspirazione	81
ADSON-MICRO Pinze anatomiche per dissezione	199	Bacinelle per strumenti	1215, 1216
ADSON-MICRO Pinze per chirurgia	210, 211	Bacinelle reniformi	1212
ADSON-MICRO TC Pinze anatomiche per dissezione	232	BACKHAUS Pinze fissatele	367
ADSON-MICRO TC Pinze per chirurgia	234	BACKHAUS-KOCHER Pinze fissatele	367
ADSON-MINI Pinze per chirurgia	210	BACON Pinze per ossa	1129
Aghi	841	BAGDLEY Divaricatori per laminectomia	559
Aghi chirurgici	514-516	BAILEY Pinze per laminectomia	1007
Aghi conduttori	66-68	BAILEY-GIBBON Approssimatori costali	800
Aghi della cardioplegia	823	BAINBRIDGE Pinze emostatiche	246
Aghi per cerume e portagarze	730	BAINBRIDGE Pinze vascolari atraumatiche	314
Aghi per eparina	73	BAKES Dilatatori per condotti biliari,	872
Aghi per iniezione	72	BALFOUR Divaricatori	485
Aghi per la puntura cieca del fegato	74	BALFOUR Divaricatori addominali	470
Aghi per la puntura dello sterno	73	BALFOUR USA Divaricatori addominali	471
Aghi per legatura	500-509, 626	BALFOUR-BABY Divaricatori addominali	469
Aghi per paracentesi	735-737	BALL & SOCKET Pinze fissatele	368
Aghi per sutura del palato	626	BALLENGER Bisturi per il setto nasale	679
Aghi per tonsille	626	BALLENGER Pinze per tonsille	621
Aghi per tonsille	72	BALLENGER Sgorbie	679
Aghi speciali	72-74	BALLENGER-HAJEK Elevatori per il setto nasale	676
AGNEW Ago per paracentesi	736	BARANY Tamburo rumoroso	716
Agrafe da sutura	516	BARBARA Microaghi	748, 749
Agrafes di argento	546	BARNES Tubi aspirazione	88
ALAN-PARKS Dilatatori per l'ano ed il retto	865	BARNHILL Coltelli per vegetazioni adenoidee	629
ALDINGER Leve per ossa	1081	BARON Tubi aspirazione	88
ALEXANDER Periostotomi	1065	BARR Dilatatori per l'ano ed il retto	861
ALEXANDER Pinze per la biopsia cervicale e da prelievo	920	Barra di trazione per tenaglie per ossa	1126
ALEXANDER Scalpelli	1030	BARRAQUER Micro-forbici	140
ALEXANDER Sgorbie	1030	BARRAQUER Pinze per ciglia	223
Algesiometro (rotella neurologica)	20	BARRON Legatore emorroidale	867
Algesiometro con ago e pennello	20	BARSKY Divaricatori	442
ALLEN Pinze intestinali	844	BARTH Curette auricolari	730
ALLIS Pinze da presa per intestino e tessuti	363, 364	BARTH Curette per ossa	1092
ALLIS-ADAIR Pinze da presa per intestino e tessuti	365	Baule di emergenza	28
ALLISON Spatole per polmone	800	BAUMGARTNER Pinze porta cavo	1159
ALM Divaricatori, autostatici	446	BAYHA Manici per bisturi	44
ALY Algesiometro	20	BAYONET-KERRISON Pinze per laminectomia	968-975
Amnioscopio	864	BEACHAM Amniotomo	903
Amniotomo	903	BEALE Uncino	748
ANDERSON-ADSON Divaricatori, autostatici	453	BEALES Bisturi per tendine	745
Anelli per legature	866	BECK Pinze per laminectomia	994
ANESTOPHONE Stetoscopi	19	BECKMANN Coltelli per vegetazioni adenoidee	628
ANKENEY Divaricatori costali	774, 783	BECKMANN Divaricatori, autostatici	459
Anoscopi	862, 863	BECKMANN Speculi nasali	662
Anse auricolari	728-730	BECKMANN-ADSON Divaricatori, autostatici	462
ANVIL Tronchesini per unghie	1206	BECKMANN-EATON Divaricatori, autostatici	463
Approssimatori costali	800	BEEBEE Forbici taglia cavo	148
Apri gesso	1193, 1194	BEER Pinze per ciglia	223
Apribocca	603-614	BEESON Apri gesso	1193
Apribocca elicoidale	619	BELLUCCI Forbici microauricolari	740
Arcelle	1212	Benda per compressione	29
Archi oer trazione	1154, 1155	BENNETT Leve per ossa	1082
ARKANSAS Pietra per affilare	58	BENGOLEA Pinze emostatiche	243, 255
ARRUGA Portaghi	496	BENSAUDE Anoscopi	862
ARRUGA TC Portaghi	531	BENSON Pinze intestinali	852
Artiglio per tessuti	830	BERGER Pinze per la biopsia cervicale e da prelievo	920
Abdominal KIT II	481	BERGMANN Bisturi per dissezione	51
		BERGMANN Divaricatori	434

<b>BERGMANN</b> Forbici per bendaggi e gessi	1190	<b>BRAUN-STADLER</b> Forbici per perineo	101
<b>BERGMANN</b> Martelli	1015	<b>BREISKY</b> Speculi vaginali	894
<b>BERGMANN</b> Seghe per gessi	1195	<b>BREISKY WIENER</b> Speculi vaginali	894
<b>BERLIN</b> Curette per biopsia	913	<b>BRIDGE</b> Pinze per preparazioni e legature	264
<b>BERLIN</b> Pinze serratubi	370	<b>BRODIE</b> Sonde scanalate	64
<b>BERLINER</b> Martelli percussori	16	<b>BROM</b> Divaricatori	431
<b>BERNHARD</b> Pinze fissatele	368	Bronchoscopia	658, 659
<b>BERTILON</b> Calibro	20	<b>BROPHY</b> Pinze anatomiche per dissezione	202
<b>BETHUNE</b> Costotomi	765	<b>BROPHY</b> Pinze per chirurgia	214
<b>BEYER</b> Pinze per ossa	1130, 1133	<b>BROWN</b> Pinze per afferrare tessuti	217
Bicchieri per medicinale	1213, 1214	<b>BROWN</b> Portaghi	490
Bicchieri graduati	1213	<b>BRUENINGS</b> Bisturi per tonsille	57
<b>BIEMER</b> Divaricatore vasi	827	<b>BRUENINGS</b> Coltelli per setto nasale	672
<b>BILL</b> Manico a trazione	936	<b>BRUENINGS</b> Lenti auricolari	727
<b>BILLEAU</b> Anse auricolari	729	<b>BRUENINGS</b> Pinze per Broncho-esofagoscopia	637
<b>BIRCHER</b> Bisturi per menisco	1147	<b>BRUENINGS</b> Pinze per setto nasale	697
<b>BIRCHER</b> Pinze da presa per menisco e cartilagine	1145	<b>BRUENINGS</b> Serranodi per tonsille	623
<b>BIRCHER</b> Retrattori per ginocchio	1148	<b>BRUENINGS</b> Spatole per lingua	600
<b>BIRCHER-GANSKE</b> Pinze da presa per menisco e cartilagine	1145, 1146	<b>BRUENINGS</b> Tubi di prolungamento	636
<b>BIRKETT</b> Pinze emostatiche	249	<b>BRUENINGS-BRUNK</b> Divaricatori nasali	687
Bisturi a falce	691	<b>BRUENINGS-LUCAS</b> Scalpelli	1029
Bisturi a falda	745	<b>BRUENINGS-LUCAS</b> Sgorbie	1029
Bisturi a lancetta	837	<b>BRUNETTI</b> Scalpelli	1049
Bisturi a rullo	746	<b>BRUNNER</b> Aghi per legatura	502, 509
Bisturi da discissione	745	<b>BRUNNER</b> Costotomi	768
Bisturi enucleatore per tonsille	622	<b>BRUNNER</b> Divaricatori	396-398, 415
Bisturi falciforme	745, 746, 748, 752	<b>BRUNNER</b> Pinze per anastomosi del retto	855
Bisturi lanceolato	747, 752	<b>BRUNNER</b> Sonde conduttrici	509, 511
Bisturi per accesso	57	<b>BRUNS</b> Curette per ossa	1095, 1106, 1107
Bisturi per cono	56	<b>BRUNS</b> Forbici per bendaggi e gessi	1190, 1191
Bisturi per dissezione	51	<b>BRYANT</b> Pinze per medicazione	352
Bisturi per fibromi	56	<b>BUCHWALD</b> Spatole per lingua	600
Bisturi per fistole	56	<b>BUCK</b> Curette auricolari	728
Bisturi per foruncoli	735	<b>BUCK</b> Forbici per legature	147
Bisturi per il setto nasale	679	<b>BUCK</b> Martelli percussori	16
Bisturi per menisco	1146, 1147	<b>BUCK</b> Miringotomo	735
Bisturi per mucosa	745	<b>BUCK</b> Pinze per corpi estranei	731
Bisturi per nervo trigemino	56, 57	<b>BUCK-GRAMCKO</b> Leve per ossa	1075
Bisturi per plastica nasale	672, 673	<b>BUECHS</b> Periostotomi	1063
Bisturi per tendine	745	<b>BUELAU</b> Trequarti	70
Bisturi per tonsille	57, 623	<b>BUMM</b> Curette uterine	928, 929
Bisturi per uso unico	49	<b>BUMM</b> Pinze per polipi e ovaie	356
Bisturi per vasi	827, 838	<b>BUNNELL</b> Enucleatore per tendine	1152, 1153
Bisturi rotondi	746, 752, 753	<b>BUNNELL</b> Trapani a mano per ossa	1172
<b>BLAKE</b> Pinze per calcoli biliari	877	<b>BUNT</b> Pinze per sterilizzazione	372
<b>BLAKESLEY</b> Pinze nasali	757	<b>BURFORD</b> Divaricatori costali	775-777
<b>BLAKESLEY-WIGAND</b> Pinze nasali	991	<b>BURKE</b> Pinze per la biopsia cervicale e da prelievo	920
<b>BLOHMKE</b> Pinze per tonsille	621	<b>BUSCH</b> Forbici ombelicali	102
<b>BLOUNT</b> Retrattori per ginocchio	1149	<b>BUSHE</b> Curette per ossa	1113
<b>BLUMENTHAL</b> Pinze per ossa	1128	<b>C</b>	
<b>BOEHLER</b> Cesioie per ossa	1142	<b>CAIRNS</b> Pinze emostatiche	251
<b>BOEHLER</b> Pinze per ossa	1132	Calibro	20,22, 559
<b>BOERMA</b> Pinza obsterica	934	<b>CANADIAN</b> Bisturi per menisco	1147
<b>BOETTCHER</b> Forbici per tonsille	116	Candelette dilatatrici	949, 950
<b>BOIES</b> Elevatori per fratture nasal	698	Cannula per insufflazione	73
<b>BONACCOLTO</b> Pinze per sutura	198	Cannule per irrigazione del seno mascellare	88
<b>BONN</b> Forbici fine per chirurgia	129	Cannule per irrigazione vascolare	73
<b>BONN</b> Micro-pinze	227	Cannule per la puntura del ventricolo cerebrale	80
<b>BONNEY</b> Pinze anatomiche per dissezione	203	Cannule per uterine	915
<b>BONNEY</b> Pinze da presa per intestino e tessuti	360	Cannule per vene	72
<b>BONNEY</b> Pinze per chirurgia	215	Cannule tracheali	654, 655
<b>BONNEY TC</b> Pinze anatomiche per dissezione	233	<b>CAPLAN</b> Cesioia per setto nasale	700
<b>BONNEY TC</b> Pinze per chirurgia	235	<b>CARDIOBASE</b> Divaricatori costali	798, 799
<b>BOROWSKI</b> Divaricatori per aorta	817	<b>CARDIOPHONE</b> Stetoscopi	19
<b>BOSE</b> Divaricatori, autostatici	445	Caricabatteria per batterie	42
<b>BOSE</b> Uncini tracheali	655	<b>CARMALT</b> Pinze per schegge	225
<b>BOUCHERON</b> Speculi auricolari	723	<b>CAROLL</b> Pinze passa tendine	1151
<b>BOWLES</b> Stetoscopi	18	<b>CAROLL</b> Goniometro per le dita	20
<b>BOWMAN</b> Stilette per canale lacrimale	62	<b>CARPENTER</b> Bisturi enucleatore per tonsille	622
<b>BOYNTON</b> Portaghi	497	<b>CARPENTER</b> Dissettori per tonsille	622
<b>BOYS-ALLIS</b> Pinze da presa per intestino e tessuti	365	<b>CARREL</b> Pinze emostatiche	251
<b>BOZEMANN</b> Forbici vascolari	131	<b>CASPAR</b> Sistema distrattore per il corpo vertebrale cervicale	560, 561
<b>BOZEMANN</b> Pinze per medicazione	353	<b>CASPAR</b> Calibro	559
<b>BOZEMANN</b> Portaghi	493	<b>CASPAR</b> Curette	1110
<b>BOZEMANN TC</b> Portaghi	526	<b>CASPAR</b> Curette per ossa	1101-1103
<b>BOZEMANN-DOUGLAS</b> Pinze per medicazione	353	<b>CASPAR</b> Dissettoie	832, 833
<b>BRAND</b> Pinze passa tendine	1152	<b>CASPAR</b> Divaricatori	388
<b>BRAUN</b> Cranioclasto	938	<b>CASPAR</b> Divaricatori per colonna cervicale	568-579
<b>BRAUN</b> Depressori uterini	900	<b>CASPAR</b> Divaricatori per colonna lombo vertebrale	582, 584
<b>BRAUN</b> Pinze per abbassare il collo dell'utero	901, 908	<b>CASPAR</b> Divaricatori per laminectomi	564-567
<b>BRAUN</b> Speculi vaginali	892	<b>CASPAR</b> Manici per bisturi	825
<b>BRAUN</b> Unico per detroncazione	937	<b>CASPAR</b> Periostotomi	562, 563
<b>BRAUN-STADLER</b> Forbici per episiotomia	101	<b>CASPAR</b> Pinze per laminectomia	987, 1000-1004





CASPAR Pinze per laminectomia, smontabile	1002, 1003	Coltello per gessi	1195
CASPAR Punzone per sutura	828	Coltello per lobi	52
CASPAR Punzoni	1024	Coltello per mucosa	673
CASPAR Separatori pr le radici dei nervi	552	Coltello per perios	53
CASPAR Speculi per chirurgia lombo vertebrale	585	Coltello per plastica nasale	672
CASPAR Unici per esplorazione e coagulazione	834	Coltello per resezione	53, 54
CASTANEDA Divaricatori costali	773, 774	Coltello per scalfire la cartilagine	672
CASTANEDA Pinze vascolari per neonati	298-299	Coltello per setto nasale	672, 673
CARSTENS Trequarti	70	Coltello per trapianti	58
CASTROVIEJO Micro-forbici	138, 139	Coltello per vegatazioni adenoidee	628, 629
CASTROVIEJO Micro-pinze	226	Coltello periostio	735
CASTROVIEJO Pinze per afferrare	47	COM divaricatori	1057
CASTROVIEJO Pinze per rompere le lamette de rasoio	47	Compressorio	1181
CASTROVIEJO Stilette per canale lacrimale	63	CONE Curette anulari	1111
Catetere guida	947	CONE Pinze per ossa del cranio	549
Cateteri metallici	951	CONVERSE Coltelli per plastica nasale	673
CATLIN Coltelli per amputazione	52	CONVERSE Divaricatori nasali	687
CAWOOD-MINNESOTA Separatori per labbra e guancia	618	CONVERSE Osteotomi	682
Cesoia per setto nasale	700	CONVERSE Uncino per ali nasali	688
Cesoie per ossa	1141-1144	COOLEY Dilatatori per aorta	810
CHADWICK Forbici fine per chirurgia	123	COOLEY Dilatatori vascolari	808
CHAPUT Pinze da presa per intestino e tessuti	366	COOLEY Divaricatori costali	769-771, 788, 789
CHARNLEY Divaricatori addominali	475	COOLEY Divaricatori per atrio	816
CHARRIÈRE Seghe per amputazione e resezione	1009	COOLEY Gancio atriale	797
CHEATTLE Pinze per strumenti sterilizzati	1209	COOLEY Pinze atraumatiche	219, 220
CHELSEA Proctoscopi	862	COOLEY Pinze vascolari atraumatiche	304, 305, 326, 330, 335-339, 342-345
CHERON Pinze per tamponi	354	COOLEY Tubi aspirazione	83
CHEVALIER Divaricatori costali	781	COOLEY-BECK Pinze vascolari atraumatiche	340
CHEVALIER-JACKSON Cannule tracheali	655	COOLEY-LEITZ Pinze vascolari atraumatiche	340
CHILDE Pinze per applicare le agrafe	517	COOPER Aghi per legatura	502
CHURCH Forbici vascolari	132	COPE Divaricatori	440
CINELLI Osteotomi	683	CORDES Pinze per Broncho-esofagoscopia	637
CITELLI Pinze per laminectomia	958	CORWIN Pinze porta cavo	1160
CITELLI-BEYER Pinze per laminectomia	958	CORYLLOS Costotomi	766
Clamp ombelicale	937	CORYLLOS Divaricatori	395
Clamps Bulldog	288-297	Costotomi	764-768
CLAR Lampade frontali	26	COTTLE Coltelli per plastica nasale	673
CLASSON Forbici vascolari	132	COTTLE Divaricatori nasali	690
CLAUS V. EICKEN Aghi per tonsille	626	COTTLE Elevatori per il setto nasale	677, 678
CLEVELAND Cesoie per ossa	1141	COTTLE Forbici nasali	120
CLEVELAND Pinze per ossa	1128	COTTLE Forbici nasali	122
CLOVER Pinze per tonsille	620	COTTLE Martelli	1013
CLOWARD Divaricatori per colonna cervicale	580, 581	COTTLE Osteotomi	680, 1031
CLOWARD Pinze per laminectomia	1006	COTTLE Periostotomi	1060
CLOWARD Separatori per vertebre	592, 593	COTTLE Pinza di fissaggio	686
CLOWARD Separatori pr le radici dei nervi	553	COTTLE Pinza per columella	686
COAKLEY Curette per seno mascellare	690-692	COTTLE Raspe nasali	1084
COAKLEY Trequarti per puntura del seno mascellare	71	COTTLE Scalpelli	680, 681
COBB Curette	1112	COTTLE Speculi nasali	666-668
COBB Elevatori	1072, 1073	COTTLE TC Forbici per tonsille	174
COBB Sgorbie spinali	1050	COTTLE Torchio per cartilagine	686
COBETT Dermotomi	59	COTTLE Uncino per ali nasali	688, 689
COBRA Pinze vascolari atraumatiche	318	COTTLE-KAZANJIAN Cesoie per ossa	1141
COEN Cannule per uterine	915	COTTLE-KNAPP Forbici nasali	122
COHEN Periostotomi	1055	COTTLE-MASING Forbici nasali	122
COLCLOUGH Pinze per laminectomia	984	COTTLE-NEIVERT Uncino per ali nasali	689
COLLER Pinze emostatiche	246	COTTLE-WALSHAM Pinze per setto nasale	698, 699
COLLIER Portaghi	492	COUPLAND Tubi aspirazione	82
COLLIN Clamp ombelicale	937	CRAFOORD Forbici per ginecologia	101
COLLIN Dinamometro	20	CRAFOORD Pinze per preparazioni e legature	266
COLLIN Divaricatori	420	CRAFOORD-SELLORS Pinze per preparazioni e legature	266
COLLIN Divaricatori addominali	466, 467	CRAIG Pinze per setto nasale	696
COLLIN Manici per bisturi	47	Cranioclasto	938
COLLIN Martelli	1016	CREDO Lima per cute ispessita	1207
COLLIN Pelvimetro	931	CRILE Divaricatori	419, 430
COLLIN Pinze da presa per intestino e tessuti	361	CRILE Pinze emostatiche	248, 258
COLLIN Pinze da presa per lingua	618	CRILE Portaghi	497
COLLIN Pinze per afferrare l'utero	910	CRILE-MURRAY Portaghi	490
COLLIN Pinze per afferrare organi	358	CRILE-RANKIN Pinze emostatiche	246, 257
COLLIN Pinze per afferrare le agrafe	518	CRILE-WOOD Portaghi	490
COLLIN Pinze per medicazione	354	CRILE-WOOD TC Portaghi	522
COLLIN Speculi vaginali	880	CRUTCHFIELD Pinza per trazione craniale	548
COLLIN-DUVAL Pinze da presa	204	Cucchia taglianti	751
COLLIN-HARTMANN Divaricatori	416	Cucchiai per calcoli biliari	873, 874
COLLIN-LOKTITE Divaricatori addominali	467	Cucchiai per placenta e per ovaie	942
Colonna vertebrale KIT	482	Cucchiai uterine	911
COLLYER Pelvimetro	931	Cucchiaio per cerume e gancio	730
Coltello interosseo	53	Cucchiaio per colecisti	873
Coltello per amputazione	52	Cucchiaio per medicine	1213
Coltello per autopsie	54, 55	Cucchiaio secreto	911
Coltello per cartilagini	53, 54	Curette	703, 704, 706-708, 831, 832, 840, 841, 1110-1112
Coltello per cervello	55	Curette anulari	1111
Coltello per dura-madre	57, 58, 553	Curette auricolari	728-730

Curette per aspirazione	914	Depressori uterini	900
Curette per biopsia	912-914	<b>DERF (WRIGHT)</b> Portaghi	491
Curette per lupus	60	<b>DERF TC</b> Portaghi	525
Curette per ossa	1091-1114	<b>DERF-CONVERSE</b> Portaghi	492
Curette per seno mascellare	690-692	<b>DERF-CONVERSE TC</b> Portaghi	525
Curette uterine	900, 924-930	Dermatologia	60, 61
<b>CUSCO</b> Speculi vaginali	880-882	Dermotomi	59
<b>CUSHING</b> Divaricatori	430, 437, 441, 444	<b>DERRA</b> Pinze vascolari atraumatiche	304
<b>CUSHING</b> Pinze anatomiche per dissezione	202	<b>DESCHAMPS</b> Aghi per legatura	503-508
<b>CUSHING</b> Pinze per chirurgia	213	<b>DESJARDINS</b> Cucchiari per calcoli biliari	873
<b>CUSHING</b> Pinze per laminectomia	995, 998	<b>DESJARDINS</b> Pinze per calcoli biliari	878
<b>CUSHING</b> Spatole cerebrali	543	<b>DESJARDINS</b> Pinze per peduncoli renali	282
<b>CUSHING TC</b> Pinze anatomiche per dissezione	233	<b>DESJARDINS</b> Sonde per calcoli biliari	872
<b>CUSHING</b> Uncini per dura-madre	555	<b>DESMARRES</b> Divaricatori	436
<b>CUSHING-BROWN</b> Pinze per chirurgia	216	Detergente per strumenti	1227
<b>CUSHING-KOCHER</b> Divaricatori	437	Diapason	713-715
<b>CUSHING-LANDOLT</b> Speculi per ipofisi	702	<b>DICK</b> Pinze per isterectomia	276
<b>CUZZI</b> Cucchiari per placenta e per ovaie	942	<b>DIEFFENBACH</b> Clamps Bulldog	292
<b>CZERNY</b> Dilatatori per l'ano ed il retto	861	<b>DIETER</b> Pinze per la testa del martelletto	744
<b>CZERNY</b> Divaricatori	420	<b>DIETHRICH</b> Clamps Bulldog	291
<b>CZERNY</b> Pinze per abbassare il collo dell'utero	906	<b>DIETRICH</b> Pinze vascolari atraumatiche	334
<b>D</b>		<b>DIETRICH-VASCULAR TC</b> Portaghi	532
<b>DAHLGREN</b> Pinze per ossa del cranio	549	Dilatatore per collo vescicale	953
<b>DAHMEN</b> Osteotomi	1051	Dilatatori per aorta	810
<b>DAHMEN</b> Sgorbie	1051	Dilatatori per condotti biliari	872
<b>DALE</b> Pinze vascolari atraumatiche	329	Dilatatori per l'ano ed il retto	861, 864-866
<b>DANDY</b> Forbici vascolari	132	Dilatatori per seno frontale	753
<b>DANDY</b> Pinze emostatiche	249, 258	Dilatatori per tracheotomia	654
<b>DANDY</b> Uncini per dura-madre	554	Dilatatori uterini	897
<b>DARDIK</b> Pinze vascolari atraumatiche	346	Dilatatori vascolari	808, 809, 827
<b>DARLING</b> Divaricatori, autostatici	452	Dinamometro	20
<b>DARTIGUES</b> Pinze per afferrare l'utero	909	<b>DINGMANN</b> Abassalingua	615
<b>DAUBENSPECK</b> Curette per ossa	1099	<b>DINGMANN</b> Apribocca	606
<b>DAUTREY-MUNRO</b> Osteotomi	1034	<b>DINGMANN</b> Tenaglie per ossa	1117
<b>DAVIDSON</b> Divaricatori	411	<b>DIPLOMAT</b> Sfigmomanometri	25
<b>DAVIS</b> Pinze per strumenti sterilizzati	1209	Dissetto	703, 708, 753, 831, 832, 835, 840, 1052, 1056
<b>DAVIS</b> Spatola per intima	813	Dissettori per la dura-madre	550, 551, 812, 813
<b>DAVIS-BOYLE</b> Abassalingua	616	Dissettori per tonsille	622, 623
<b>DAVIS-BOYLE</b> Apribocca	608-612	Dissettori sferici	840
<b>DAVIS-MEYER</b> Abassalingua	616	Dissettori vascolari	814
<b>DAVIS-MEYER</b> Apribocca	607	Distributore lame	48
<b>DAY</b> Uncini auricolari	731	Distributori di cotone	1217
<b>DE BAKEY</b> Clamps Bulldog	288, 289	<b>DITTEL</b> Catetere guida	947
<b>DE BAKEY</b> Dilatatori vascolari	809	Divaricatore mammoplastica	422
<b>DE BAKEY</b> Divaricatori costali	786, 787	Divaricatore per dita	1183
<b>DE BAKEY</b> Divaricatori, autostatici	464	Divaricatore per ossa e articolazione	1184
<b>DE BAKEY</b> Forbici per dissezione	115	Divaricatore per velo pendulo	627
<b>DE BAKEY</b> Forbici vascolari	134, 135	Divaricatore vasi	827
<b>DE BAKEY</b> Pinze atraumatiche	219, 220	Divaricatore vulvare	896
<b>DE BAKEY</b> Pinze vascolari atraumatiche	300-303, 309-311, 313, 314, 316, 317, 321, 322, 325, 328, 330	Divaricatori	374-486
<b>DE BAKEY TC</b> Forbici vascolari	179	Divaricatori addominali	465-477
<b>DE BAKEY TC</b> Pinze atraumatiche	236	Divaricatori atrio	824
<b>DE BAKEY TC</b> Portaghi	522, 523	Divaricatori costali	769-799
<b>DE BAKEY</b> Tubi aspirazione	84	Divaricatori costali in Alluminio	769-776
<b>DE BAKEY-BAHNSON</b> Pinze vascolari atraumatiche	310	Divaricatori epicardici	817
<b>DE BAKEY-BECK</b> Pinze vascolari atraumatiche	305	Divaricatori mammaria	794-797
<b>DE BAKEY-CAROTIS</b> Clamps Bulldog	297	Divaricatori nasali	687-690
<b>DE BAKEY-DIETHRICH</b> Clamps Bulldog	294	Divaricatori per aorta	816, 817
<b>DE BAKEY-MIXTER</b> Pinze vascolari atraumatiche	300	Divaricatori per atrio	816
<b>DE BAKEY-MOSQUITO</b> Pinze vascolari atraumatiche	307	Divaricatori per colonna cervicale	568-581
<b>DE BAKEY-PEAN</b> Pinze vascolari atraumatiche	306	Divaricatori per colonna lombo vertebrale	582-585
<b>DE BAKEY-RANKIN</b> Pinze vascolari atraumatiche	307	Divaricatori per disco intervertebrale	594
<b>DE BAKEY-RUMEL</b> Pinze vascolari atraumatiche	300	Divaricatori per laminectomi	556-559, 564-567, 586-591
<b>DE BAKEY-SATINSKY</b> Clamps Bulldog	297	Divaricatori per tessuti molli	384, 385
<b>DE BAKEY-SATINSKY</b> Pinze vascolari atraumatiche	331	Divaricatori vescicali	952
<b>DE LEE</b> Pinza obsterica	932	Divaricatori, autostatici	445-464
<b>DE MARTEL</b> Guida per fili per sega	549	<b>DIXON-LOVELACE</b> Pinze emostatiche	247, 257
<b>DE MARTEL-WOLFSON</b> Pinze anastomosi	845	<b>DOCKHORN</b> Divaricatori	387
<b>DE MARTEL-WOLFSON</b> Portapinze	845	<b>DOUAY</b> Pinze per la biopsia cervicale e da prelievo	920
<b>DE MARTEL-WOLFSON</b> Serrapinze	845	<b>DOUGHTY</b> Abassalingua	615
<b>DE VILBISS</b> Pinze per ossa del cranio	549	<b>DOUGLAS</b> Pinze per ciglia	223
<b>DEAN</b> Forbici per tonsille	116	<b>DOUGLAS</b> Trequarti per puntura del seno mascellare	71
<b>DEAN TC</b> Forbici per tonsille	174	<b>DOYEN</b> Abassalingua	602
<b>DEAVER</b> Divaricatori	426, 427, 485	<b>DOYEN</b> Divaricatori	402
<b>DEAVER</b> Forbici per chirurgia	96	<b>DOYEN</b> Divaricatori addominali	480
<b>DECKER</b> Pinze per laminectomia	1006	<b>DOYEN</b> Forbici per pareti abdominali	97, 98
<b>DEJERINE</b> Martelli percussori	16	<b>DOYEN</b> Periototomi	1066, 1067
<b>DEMEL</b> Guida cavo	1158	<b>DOYEN</b> Pinze fissatele	368
<b>DEMEL</b> Strumenti per cerchiaggio	1158	<b>DOYEN</b> Pinze intestinali	844-847
<b>DENHARDT</b> Apribocca	603	<b>DOYEN</b> Pinze per polipi e ovaie	356
<b>DENNIS-BROWNE</b> Divaricatori addominali	471	<b>DOYEN</b> Portaghi	492
<b>DENNIS-BROWNE</b> Pinze per afferrare tessuti	204	<b>DOYEN</b> Sonde scanalate	63
		<b>DOYEN</b> Speculi vaginali	893



DOYEN Succhielli per fibroma	908	FILIFORM Candelette dilatatrici	949
DOYEN-CHILD Divaricatori addominali	480	Filo per ossa	1157
DOYEN-COLLIN Apribocca	603	Filo per serranodi	624, 652, 671, 738
DOYEN-JANSEN Apribocca	603	FINOCHIETTO Divaricatori costali	771-773, 784, 785
DOYEN-STILLE Divaricatori	408	FINOCHIETTO Pinze per preparazioni e legature	280
DRAFFIN Supporto per gli apribocca	617	FINOCHIETTO Portaghi	494
DUBOIS Forbici per decapitazione	100	FINOCHIETTO TC Portaghi	527
DUEHRSSSEN Pinze anatomiche per dissezione	203	FINSSEN Divaricatori, autostatici	445
DUEHRSSSEN Pinze per chirurgia	215	FINSTERER Tubi aspirazione	84
DUKE Tre quarti	71	FISCHER Bisturi per tonsille	623
DUNN-DAUTREY Osteotomi	1026	FISCHER Enuclatore per tendine	1153
DUPLAY Pinze per abbassare il collo dell'utero	902	Fissatore per mano	1182
DUPLAY Pinze per medicazione	351, 352	Flebo-dissetto	814
DUPLEX Stetoscopi	18	Flebo-estrattore	814
DUPUY-WEISS Aghi per legatura	626	FOERSTER Pinze per tamponi e spugne	359
DURANTE Pinza vascolare e per tumori	218	FOERSTER-BALLENGER Pinze per tamponi e spugne	359
DUVAL Pinze da presa	204	FOMON Coltelli per plastica nasale	672
DUVAL Pinze da presa per intestino e tessuti	360, 361	FOMON Forbici nasali	118, 119, 121
DUVAL-COLLIN Pinze da presa per intestino e tessuti	361	FOMON Osteotomi	683
<b>E</b>		FOMON Raspe nasali	1086, 1090
ECHLIN Pinze per ossa	1135	FOMON SCT Forbici nasali	189
EDER Portacotone	66	FOMON TC Forbici per tonsille	174
EICKEN Cannule per irrigazione del seno mascellare	88	FOMON Uncino nasale ad anello	689
EISELSBERG Forbici per legature	147	FOMON Uncino per ali nasali	688, 689
EISELSBERG Portaghi	497	Forbice per capsula	105
Elastico naso-pharyngo-laryngofiberscopia	598	Forbice per dissezione rettale	106, 107
Elevatori	737, 840, 1052-1056, 1072-1074	Forbici	91-148
Elevatori d'aspirazione	674, 678	Forbici con lame in carburo i tungsteno	160-181
Elevatori per fratture nasal	698	Forbici da utero	98-100, 151, 152
Elevatori per il setto nasale	674-678	Forbici fine per chirurgia	123-130, 156-157
ELSAESSER Pinze per nefrostomia	876	Forbici microauricolari	740, 744
EMMET Divaricatori	436	Forbici nasali	118-122, 156, 754
EMMET Pinze per medicazione	354	Forbici ombelicali	102
Endospeculi	896	Forbici per bendaggi e gessi	1186-1192
ENGEL Seghe per gessi	1195	Forbici per cartilagini	115, 116
Enucleatore	705	Forbici per chirurgia	91-97, 103-105, 151-153
Enucleatore per tendine	1152, 1153	Forbici per decapitazione	100
EPPENDORF Pinze per la biopsia cervicale e da prelievo	920, 922	Forbici per dissezione	108-115, 154-156
Escavatore	747	Forbici per enterotomia	103
ESMARCH Coltelli per gessi	1195	Forbici per episiotomia	101, 102, 152
ESMARCH Forbici per bendaggi e gessi	1190	Forbici per Face-lift	117
Estesiometro	20	Forbici per gengiva	124, 125
EVES Serranodi per tonsille	623	Forbici per ginecologia	98-102
EWALD Pinze anatomiche per dissezione	198	Forbici per la chirurgia plastica	115
EWALD Pinze per chirurgia	209	Forbici per legature	146, 147
<b>F</b>		Forbici per pareti abdominali	97, 98
FAHLBUSCH Curetta	707	Forbici per perineo	101, 102, 152
FAHLBUSCH Curetta	707	Forbici per tonsille	116, 117
FAHLBUSCH Microforbici da presa	651	Forbici per unghie	1204
FANSLER Anoscopi	862	Forbici SUPERCUT	150-158
FARABEUF Divaricatori	417	Forbici SUPERCUT NITRITO di TITANO	184-192
FARABEUF Periostotomi	1063	Forbici taglia cavo	148
FARABEUF Tenaglie per ossa	1120	Forbici vascolari	131-137, 158
FARABEUF-COLLIN Periostotomi	1063	Forbici vascolari	115, 117
FARABEUF-LAMBOTTE Tenaglie per ossa	1120	Forcella di guida	747, 752
FARRELL Portacotone	65	Forchetta da sutura	513
FARRIOR Specoli auricolari	720, 724	Forchetta per impiantare	705
Fascia frontale	35	FORD-DIXON Legatore emorroidale	868
FAULKNER Curette per seno mascellare	690	FORMBY Cucchiato per cerume e gancio	730
FAURE Pinze per isterectomia	272	FOSTER-GILLIES TC Portaghi	528
FAURE Pinze per la biopsia cervicale e da prelievo	916	FOWLER Bisturi per tonsille	57
FAURE Pinze per peritoneo	278	FOX Curette per lupus	60
FAVALORO Forbici vascolari	134	FRAENKEL Pinze per Broncho-esofagoscopia	637
FAVALORO Divaricatori costali	775	FRAENKEL Pinze per polipi laringei	634, 635
FEHLAND Pinze per anastomosi del retto	856	FRANCKE Lancetta pungidito	29
FEILCHENFELD Pinze per schegge	225	FRANZ Divaricatori addominali	474
FEIN Portacotone	633	FRASER-KELLY Pinze emostatiche	248
FELDHEIM Compressorio	1181	FRAZIER Cannule per la puntura del ventricolo cerebrale	80
FERGUSON Cucchiati per calcoli biliari	874	FRAZIER Dissettori per la dura-madre	551
FERGUSON Forbici per chirurgia	97	FRAZIER Tubi aspirazione	77
FERGUSON Pinze intestinali	853	FRAZIER Uncini per dura-madre	555
FERGUSON Pinze per anastomosi del retto	855	FREEMAN-GORNEY TC Forbici per Face-lift	176
FERGUSON Tenaglie per ossa	1119	FREEMAN-KAYE TC Forbici per Face-lift	176
FERGUSON Tubi aspirazione	78, 79	FREER Coltelli per mucosa	673
FERGUSON-ACKLAND Apribocca	603	FREER Divaricatori	443
Fermapinza	936	FREER Elevatori	1054
FERRIS-SMITH Pinze per chirurgia	215	FREER Elevatori per il setto nasale	674, 675
FERRIS-SMITH TC Pinze per chirurgia	235	FREER Scalpelli	1025
FERRIS-SMITH-CUSHING Pinze per laminectomia	979-983	FREER Sgorbie	1025
FERRIS-SMITH-CUSHING Pinze per laminectomia, smontabile	981, 983	FREER-GORNEY Elevatori d'aspirazione	674
FERRIS-SMITH-KERRISON Pinze per laminectomia	960-967, 978	FREER-JOSEPH Elevatori per il setto nasale	675
FICKLING Pinze per preparazioni e legature	269	FREER-YASARGIL Elevatori per il setto nasale	674
Fili per sega	1010	FRENZEL Spatole per lingua	600

FRIEDMANN-JOLL Divaricatore vulvare	896	GROSS-MAIER Pinze per medicazione	349, 350
FRIEDMANN-MINI Pinze per ossa	1127	GRUBER Specoli auricolari	725
FRIEDMANN-VICKERS Pinze per ossa	1127	GRUENWALD Pinze nasali	757
FRITSCH Divaricatori	403	GRUENWALD Polverizzatori	761
FRY Pinze nasali	990	GRUENWALD-HENKE Pinze nasali	991
FRYKHOLM Pinze per ossa	1136	GRUENWALD-JANSEN Pinze auricolari e nasali	222
FUCHSIG Pinze emostatiche	247	Guancio per mento	383, 1057
FULLER Pinza per introduzione per protesi in teflon	742	Guida cavo	1158, 1159
<b>G</b>		Guida per fili per sega	549
GALLAHER Raspe nasali	1085	Guida per legatura	829
Ganci galea	545	Guida per tendine	1153
Gancio atriale	792, 797	GUILLEN Elevatori d'aspirazione	678
Gancio fenestrato	747	GUILFORD-WRIGHT Forbici taglia cavo	148
GARDNER Cesoie per ossa	1141	GULEKE Pinze per ossa	1131
GARRETT Dilatatori vascolari	809	GUNAR-HEY Pinze serratubi	371
GAST Abassalingua	615	GUSTELLA Osteotomi	684
GAUSS Pinza per il cuoio capelluto	936	GUTHRIE Divaricatori	432
GELFOAM Pinze per setto nasale	701	GUYON Candelette dilatatrici	949
GELLHORN Pinze per la biopsia cervicale e da prelievo	919	GUYON Catetere guida	947
GELPI Divaricatori	485	GUYON Pinze per peduncoli renali	282-284
GELPI-LOKTITE Divaricatori, autostatici	456, 457	GWYNE-EVANS Dissettori per tonsille	623
GELPI-SEILETZ Divaricatori, autostatici	457	<b>H</b>	
GEMINI Pinze per preparazioni e legature	265	HABERER Spatole addominali e intestinali	421
GERALD Pinze anatomiche per dissezione	202	HACKSTOCK Pinze porta cavo	1161
GERALD Pinze auricolari e nasali	222	HAGLUND-STILLE Apri gesso	1193
GERALD Pinze per chirurgia	214	HAIGHT Divaricatori costali	781
GERALD TC Pinze anatomiche per dissezione	233	HAJEK Martelli	1013
GERALD TC Pinze per chirurgia	235	HAJEK Pinze nasali	991
GERALD-BROWN Pinze per chirurgia	216	HAJEK Tubi aspirazione	87
GERSTER Barra di trazione per tenaglie per ossa	1126	HAJEK-CLAUS Pinze per laminectomia	958
GERZOG Martelli	1017	HAJEK-KOFLER Pinze per laminectomia	959
GERZOG-SEXTON Ago per paracentesi	735	HAKANSSON Pinze per ossa	1128
Ghiaccia unghie	1207	HALLE Coltello per dura-madre	553
GIERTZ-STILLE Costotomi	767	HALLE Curette per ossa	1098
GIGLI Fili per sega	1010	HALLE Elevatori per il setto nasale	674
GIGLI Manico ad uncino per fili per sega	1010	HALSEY Portaghi	491
GILLIES Divaricatori	442	HALSEY TC Portaghi	524
GILLIES Osteotomi	1026	HALSTED-MOSQUITO Pinze emostatiche	244, 250, 256, 258, 259
GILLIES Pinze anatomiche per dissezione	199	HARDY Curetta	707
GILLIES Pinze per chirurgia	211	HARDY Eucleatore	705
GILLIES Portaghi con forbici	495	HARDY Forchetta per impiantare	705
GILLIES TC Pinze per chirurgia	234	HARDY-FAHLBUSCH Dissettori	703
GILLIES TC Portaghi	528	HARGIS Separatore per il corpo mandibulare	1057
GILLIES-MINI TC Portaghi	528	HARGIS Separatore per il borde anteriore	1057
GILL-VERNET Divaricatori	438	HARKEN Pinze per vena cava	348
GLASSMANN Pinze atraumatiche	218	HARKEN Pinze vascolari atraumatiche	334
GLOVER Clamps Bulldog	290, 296	HARRINGTON Divaricatori	409
GLOVER Pinze vascolari atraumatiche	303, 315, 316	HARRINGTON Divaricatori	485
GLUCK Costotomi	764	HARRINGTON-PEMBERTON Divaricatori	409
GOLDMANN Elevatori per fratture nasal	698	HARTMANN (FRENCH) Diapason	713
GOLDMANN-FOX Forbici per gengiva	125	HARTMANN Abassalingua	601
GOLDMANN-FOX TC Forbici per gengiva	177	HARTMANN Diapason	713-715
GOELET Divaricatori	418	HARTMANN Pinze auricolari	732, 733
GOMEL Micro-forbici	143	HARTMANN Pinze emostatiche	250
Goniometro	20	HARTMANN Pinze intestinali	846
Goniometro per le dita	20	HARTMANN Pinze nasali	992
GOOD Forbici per tonsille	117	HARTMANN Pinze per ossa	1129
GOOD-SCHWEKENDIECK Forbici per tonsille	117	HARTMANN Pinze per polipi auricolari	732
GORNEY Forbici per dissezione	113	HARTMANN Pinze per tamponi e polipi nasali	669, 670
GORNEY TC Forbici per Face-lift	175	HARTMANN Portacotone	633
GORNEY-FREEMAN TC Forbici per Face-lift	176	HARTMANN Sonda auricolare	716
GOSSET Divaricatori addominali	469	HARTMANN Specoli auricolari	721-723
GOSSET-BABY Divaricatori addominali	469	HARTMANN Speculi nasali	661, 662
GOURDET Curette uterine	924	HARTMANN Uncini auricolari	731
GRAEFE Bisturi per dissezione	51	HARTMANN-HALLE Speculi nasali	661
GRAEFE Divaricatori	429, 431	HARTMANN-HOFFMANN Pinze auricolari	733
GRAEFE Forbici fine per chirurgia	129	HARTMANN-NOYES Pinze auricolari	733
GRAEFE Pinze per afferrare tessuti	209	HARTMANN-WEINGAERTNER Pinze auricolari	733
GRAEFE Pinze per iridectomia	197, 208	HARTMANN-WULLSTEIN Pinze auricolari	732
GRAEFE Pinza per afferrare la pelle	686	HARVEY Forbici taglia cavo	148
GRAHAM Uncini per dura-madre	554	HARVEY-JACKSON Divaricatori, autostatici	463
GRAVE Speculi vaginali	883, 884, 886, 887	HASLINGER Divaricatore per velo pendulo	627
GRAY Pinze per preparazioni e legature	280	HASOBUCCHI Forchetta	706
GREEN-ARMYTAGE Pinza emostatiche	936	HATFIELD Curette per ossa	1112, 1113
GREGORY Pinze vascolari atraumatiche	326	HAYES Pinze per anastomosi del retto	857
GREGORY SCT Forbici per Face-lift	190	HEANEY Pinze per isterectomia	274
GREGORY TC Forbici per Face-lift	175	HEANEY Portaghi	492
GREGORY-SOFT Clamps Bulldog	297	HEANEY TC Portaghi	526
GREVEN Micropinze per piegare fili metallici	741	HEANEY-RAZAK Pinze per isterectomia	274
GREY-TURNER Pinze emostatiche	256	HEANLEY Pinze per ossa	1127
GRONINGEN Uncini per dura-madre	554	HEART-GATE Ago della cardioplegia	823
GROSS Anse auricolari	730	HEART-GATE Divaricatori costali	791, 792
GROSS Pinze per medicazione	350, 351	HEART-GATE Gancio atriale	792, 793





HEART-GATE Magnete di barra	822
HEART-GATE Manici per bisturi	823
HEART-GATE Pinza di inserimento valve atriali	820
HEART-GATE Porta-legature	822
HEART-GATE Righello del suturare	823
HEART-GATE Strumenti per miniinvasiva chirurgia	818-823
HEART-GATE Supporto valve atriali	820
HEART-GATE Unicini pere nervi e vasi	822
HEART-GATE Valve atriali	820
HEATH Forbici per legature	147
HEATH Martelli	1015
HEGAR Dilatatori uterini	897, 898
HEGAR Portaghi	488
HEGAR TC Portaghi	521
HEGAR-BAUMGARTNER Portaghi	490
HEGAR-BAUMGARTNER TC Portaghi	524
HEGAR-VASCULAR TC Portaghi	532
HEGEMANN-DIETRICH Forbici vascolari	137, 158
HEGEMANN-DIETRICH SCT Forbici vascolari	191
HEGEMANN-DIETRICH TC Forbici vascolari	180
HEGENBARTH Pinze per applicare le agrafe	517
HEIFETZ Spatole cerebrali	543
HEIMING Pinze per nefrostomia	874
HEISS Pinze emostatiche	244, 256
HEISTER Apribocca	603
HELFFERICH-BIER Seghe per amputazione e resezione	1009
HEMINGWAY Curette per ossa	1093
HENDERSON Divaricatori, autostatici	449
HENKE Dissettori per tonsille	622
HENLEY Divaricatori, autostatici	450, 451
HENLEY Pinze vascolari atraumatiche	331
HENNIG Apri gesso	1193
HEPP-SCHIEDL Micro-forbici	143
HERBERHOLD Abassalingua	616
HERMANN Martello	751
HERMANN Scalpelli	751
HERMANN Sgorbia	751
HERRICK Pinze per peduncoli renali	283
HERTZLER Divaricatori costali	780
HERZ Pinze da presa per menisco e cartilagine	1145
HERZ Pinze passa tendine	1150
HESS Clamps Bulldog	292
HEY-GROVES Tenaglie per ossa	1123
HEYMANN Forbici nasali	120, 156
HEYMANN Pinze per setto nasale	696
HEYMANN SCT Forbici nasali	190
HEYMANN-KNIGHT Pinze per tamponi e polipi nasali	670
HEYWOOD-SMITH Pinze per polipi e ovaie	357
HIBBS Osteotomi	1038
HIBBS Scalpelli	1038
HIBBS Sgorbie	1039
HIRSCHMANN Anoscopi	863
HOEN Dissettori per la dura-madre	551
HOEN Periostotomi	1068
HOEN Pinze per laminectomia	1007
HOEN V. EICKEN Portalegature	627
HOESEL Divaricatori	408
HOESEL TC Portaghi	530
HOFF Pinze fissatele	369
HOHMANN Leve per ossa	1077-1079
HOKE Osteotomi	1037
HOLINGER Laringoscopi per operazione	641
HOLSHER Separatori pr le radici dei nervi	553
HOLZBACH Divaricatori addominali	475
HOLZBACH Pinze emostatiche	258
HOLZHEIMER Divaricatori, autostatici	445
HOPKINS Coltelli per gessi	1195
HORSLEY Separatori pr le radici dei nervi	552
HOUSE Cucchia taglienti	751
HOUSE Microaghi	748
HOUSE Periostotomo	747
HOUSE Tubi aspirazione	86
HOUSE Uncini tracheali	656
HOUSE-DIETER Pinze per la testa del martelletto	742
HOWARTH Elevatori per il setto nasale	678
HUBER Manico universale	636, 923
HUDSON Trapani a mano per ossa	1172
HUGHES Uncino per staffa	747
HUMBY Dermotomi	59
HUNTER Pinze per schegge	225
HURD Aghi per sutura del palato	626
HURD Dissettori per tonsille	622
HUSFELDT Pinze vascolari atraumatiche	327

## I

I.M.A. Divaricatori mammaria	794-797
INGE Separatori per vertebre	592
Insoffiatore d'aria	716, 717
Insufflatore	718
IOWA Ago per iniezione	72
IOWA Pinze per abbassare il collo dell'utero	905
IRIS Forbici fine per chirurgia	127-129, 157
IRIS SCT Forbici fine per chirurgia	191
IRIS TC Forbici fine per chirurgia	178
Irrigatori	1215
IRWIN Divaricatori, autostatici	456
ISRAEL Divaricatori	380
Isterometri	899
ITERSON Uncini tracheali	655
IVES-FANSLER Anoscopi	863

## J

JABALEY Forbici fine per chirurgia	130, 157
JACKSON Pinza tendine	1150
JACKSON Speculi vaginali	893
JACKSON Uncini tracheali	656
JACKSON-BURROWS Divaricatori, autostatici	457
JACOBS Pinze per abbassare il collo dell'utero	906
JACOBSON Bisturi per vasi	827, 838
JACOBSON Curette per ossa	1091
JACOBSON Punzone per sutura	827, 828
JACOBSON Sond doppia	827
JACOBSON Sonda bottonuta	827, 828
JAEGER Pinze da presa per menisco e cartilagine	1145
JAEGER Pinze passa tendine	1151
JAMESON Calibro	22
JAMESON Forbici per dissezione	114, 155
JAMESON Portaghi	492
JAMESON SCT Forbici per dissezione	189
JAMESON TC Forbici per dissezione	172
JANET Siringhe	75,76
JANSEN Curette auricolari	730
JANSEN Curette per ossa	1091, 1092
JANSEN Divaricatori, autostatici	446
JANSEN Lampade frontali	27
JANSEN Periostotomi	1060, 1064
JANSEN Pinze auricolari e nasali	222
JANSEN Pinze per ossa	1129, 1130
JATHO Pinze naso-faringe	631
JAVID Pinze vascolari atraumatiche	326, 327
JENNINGS Apribocca	605
JIKEI Pinze nasali	759, 760
JOBSON-HORNE Portacotone	65
JOHN-HOPKINS Clamps Bulldog	292, 293
JOHN-HOPKINS Pinza per applicare le pinze bulldog	293
JOHNS-HOPKINS Pinze per preparazioni e legature	281
JONES Pinze fissatele	369
JORGENSON Forbici vascolari	132
JOSEPH Coltelli per plastica nasale	672, 673
JOSEPH Coltelli per setto nasale	673
JOSEPH Divaricatori	443
JOSEPH Elevatori per il setto nasale	677
JOSEPH Forbici fine per chirurgia	123
JOSEPH Periostotomi	1053
JOSEPH Raspe nasali	1084
JOSEPH SCT Forbici fine per chirurgia	190
JOSEPH Seghe nasali	685
JOSEPH TC Forbici fine per chirurgia	177
JOSEPH TC Forbici per dissezione	172
JOSEPH-MASING Elevatori per il setto nasale	677
JUDD-ALLIS Pinze da presa per intestino e tessuti	365
JUDD-MASSON Divaricatori vescicali	952
JUERS Micropinze per piegare fili metallici	742
JURASZ Pinze naso-faringe	631
JURASZ Pinze per polipi laringei	634

## K

KABIERSKE Insufflatore	718
KADER Divaricatori	425
KAHN Forbici per Face-lift	117
KALLMORGEN Speculi vaginali	891
KALT Portaghi	497
KANE Clamp ombelicale	937
KANTROWITZ Pinze per preparazioni e legature	266
KARLIN-CRANK Divaricatori per laminectomi	588
KATSCH Tiracomedoni	61
KATZIN Micro-forbici	142
KATZIN-BARRAQUER Micro-forbici	142
KAYE Forbici per Face-lift	118

KAYE TC Forbici per Face-lift	175	KRAUSE Tre quarti per puntura del seno mascellare	71
KAYE-MILLARD Divaricatori	444	KRAUSE-VOSS Serranodi auricolari	738
KELLY Divaricatori	406, 412, 413, 485	KRAUSE-VOSS Serranodi per polipi	671
KELLY Forbici fine per chirurgia	123, 156	KRAYENBUEHL Unicini pere nervi e vasi	829
KELLY Pinze emostatiche	249	KRESSNER Pinze per setto nasale	699
KELLY Pinze per polipi e ovaie	356	KRISTELLER Speculi vaginali	889-890
KELLY Pinze per preparazioni e legature	270	KRISTELLER WIENER Speculi vaginali	891
KELLY SCT Forbici fine per chirurgia	190	KROENLEIN Pinze emostatiche	251
KELLY Sfinteroscopi	863	KRONECKER Aghi per legatura	502
KELLY TC Forbici fine per chirurgia	177	KUEHNE Pinze porta-lamelle	226
KELLY-RANKIN Pinze emostatiche	247	KUEMMEL Divaricatori	401, 424
KELMAN-MC PHERSON Micro-pinze	227	KUESTNER Pinze per abbassare il collo dell'utero	904
KERN-LANE Tenaglie per ossa	1119, 1121	<b>L</b>	
KERPEL Curette per ossa	1114	LA FORCE Adenotomi	630
KERRISON Pinze per laminectomia	958, 976, 977	LA GRANGE Forbici per gengiva	124
KERSTING Pinze per anastomosi del retto	858	LABORDE Dilatatori per tracheotomia	654
KEVORKIAN Curette per biopsia	912	LACK Abassalingua	601
KEVORKIAN Pinze per la biopsia cervicale e da prelievo	920, 922	LAHEY Divaricatori	438
KEVORKIAN-PACIFIC Pinze per la biopsia cervicale e da prelievo	921	LAHEY Pinza da presa per gozzo	657
KEY Periostotomi	1068	LAHEY Pinze per abbassare il collo dell'utero	908
KEYES Trefine cutanee	60	LAHEY Pinze per preparazioni e legature	280, 281
KIELLAND Pinza obsterica	933	Lama del tumore	836, 837
KILLIAN Cesoaia per setto nasale	700	LAMBERT-KAY Pinze vascolari atraumatiche	330
KILLIAN Elevatori	1055	LAMBOTTE Divaricatori	378
KILLIAN Elevatori per il setto nasale	678	LAMBOTTE Osteotomi	1034
KILLIAN Periostotomi	1055	LAMBOTTE Periostotomi	1065
KILLIAN Pinze per tamponi e polipi nasali	670	LAMBOTTE Tenaglie per ossa	1124, 1125
KILLIAN Portacotone	633	Lame per bisturi	48, 50
KILLIAN Sgorbie	679	Lamette di rasoio	47, 1207
KILLIAN Speculi nasali	663-666	Lampade frontali	26-27
KILLIAN-CLAUS Sgorbie	679	Lancetta pungidito	29
KILLIAN-RUDERT Speculi nasali	665	LANDAU Speculi vaginali	893
KILNER (RAGNELL) Forbici per dissezione	113, 155	LANDAU Tre quarti	71
KILNER Divaricatori	419, 439, 442	LANDOLT Curetta	706
KILNER Forbici fine per chirurgia	126	LANDOLT Curetta	706
KILNER Portaghi	491	LANDOLT Enuclatore	706
KILNER TC Forbici per dissezione	172	LANDOLT Forbici nasali	121
KILNER TC Portaghi	525	LANDOLT Manici per bisturi	826
KILNER Uncino per ali nasali	688	LANDOLT Periostotomi	562
KILNER-DOUGHTY Apribocca	613	LANDOLT Pinza divaricatore per speculum	702
KIRK Martelli	1017	LANDOLT Pinze per laminectomia	1005
KIRKLIN Divaricatori	438	LANDOLT Uncini	706
KIRSCH Divaricatori	388	LANDOLT-REULEN Curetta	708
KIRSCHNER Archi oer trazione	1154, 1155	LANDOLT-REULEN Dissettori	708
KIRSCHNER Divaricatori addominali	472, 473	LANDOLT-REULEN Periostotomo	708
KIRSCHNER Sonda conduttrici	510, 511	LONDON Speculi vaginali	892
KLAPP Divaricatori	433	LANE Leve per ossa	1076
KLEINERT-KUTZ Divaricatori	444	LANE Pinze fissatele	368
KLEINERT-KUTZ Pinze passa tendine	1152	LANE Pinze intestinali	853
KLEINERT-KUTZ Pinze per ossa	1127, 1132	LANE Pinze per chirurgia	215
KLEINSCHMIDT Pinze intestinali	852	LANE-TRETHOWAN Leve per ossa	1076
KLIMA-ROSEGGER Aghi per la puntura dello sterno	73	LANGE Divaricatori	436
KLINKENBERGH-LOTH Forbici vascolari	131	LANGE Forbici per bendaggi	1186
KNAPP Divaricatori	432	LANGE Pinze per Broncho-esofagoscopia	637
KNIGHT Forbici nasali	121	LANGE-HOHMANN Leve per ossa	1079, 1080
KNIGHT Pinze per setto nasale	696	LANGENBECK Anse auricolari	728
KNIGHTON Separatori per vertebre	593	LANGENBECK Coltelli per amputazione	52
KNOWLES Forbici per bendaggi	1186	LANGENBECK Coltelli per resezione	53
KOCHER Aghi per legatura	502	LANGENBECK Divaricatori	381-383
KOCHER Divaricatori	376, 392, 399, 404	LANGENBECK Elevatori	1074
KOCHER Pinze emostatiche	254, 255	LANGENBECK Periostotomi	1064
KOCHER Pinze intestinali	846, 848	LANGENBECK Protettore per dita	619
KOCHER Sonda per gozzo	657	LANGENBECK Seghe per amputazione e resezione	1010
KOCHER Spatole vescicali	953	LANGENBECK TC Portaghi	531
KOCHER-LANGENBECK Divaricatori	389, 390	LANGENBECK Tenaglie per ossa	1118
KOCHER-WAGNER Divaricatori	405	LANGENBECK-RYDER TC Portaghi	534
KOELNER Agrafes emostatici per cuoio capelluto	546	LANGE-WILDE Serranodi auricolari	738
KOENIG Diapason	714	LANGE-WILDE Serranodi per polipi	671
KOENIG Divaricatori	437	LANG-STEVENSON Pinze intestinali	852
KOENIG Elevatori	1052	Laringologia	652, 653
KOENIG Periostotomi	1053	Laringoscopi di luce fredda ed accessori	40-41, 43
KOENIG Sonda conduttrici	512	Laringoscopi ed accessori	36-43
KOERTE Divaricatori	379	Laringoscopi per operazione	638-641
KOERTE Divaricatori	424	LAWRENCE Pinze per preparazioni e legature	264
KOGAN Endospeculi	896	LEBSCHKE Guida per fili per sega	549
KONRICH Scatole per sterilizzare bendaggi	1224	LEBSCHKE Scalpello per sterno	764
KOOS Bisturi per vasi	838	LEES Pinze vascolari atraumatiche	314, 323
KRAEMER Divaricatori	388	Legatore emorroidale	866-868
KRAEMER Periostotomi	1063	LEGUEU Divaricatori vescicali	952
KRAUS Bisturi per vasi	838	LEGUEU Spatole vescicali	953
KRAUSE Pinze per Broncho-esofagoscopia	637	LEKSELL Pinze per ossa	1137
KRAUSE Serranodi auricolari	738	LEKSELL-STILLE Pinze per ossa	1137
KRAUSE Serranodi per polipi	671	LELAND-JONES Pinze vascolari atraumatiche	317-319



LEMPERT Curette per ossa	1098
LEMPERT Elevatori	737
LEMPERT Periostotomi	1054
LEMPERT Tubi aspirazione	80
Lenti auricolari	726, 727
Lenti dingrandimento	23
LERCHE Pinze per chirurgia	218
LERICHE Divaricatori	423
LERICHE Pinze emostatiche	247, 257
Leva auricolare	730
Leva osetrica	936
Leva per corpi estranei	731
Leva per lussazione	1083
Leve per ossa	1075-1083
LEWIN Pinze per riposizioni	1116
LEWIS Raspe nasali	1084
LEWKOWITZ Pinze per calcoli	945
LEXER Forbici per dissezione	112, 155
LEXER Osteotomi	1043, 1047
LEXER Scalpelli	1042
LEXER SCT Forbici per dissezione	188
LEXER Sgorbie	1043, 1044, 1048
LEXER Sgorbie per tessuto osseo spugnoso	1045, 1048
LEXER TC Forbici per dissezione	171
LEXER-BABY Forbici per dissezione	112
LEXER-MINI Osteotomi	1041
LEXER-MINI Sgorbie	1041
LEYLA Autofissatore per retrattori, per il supporto del craino	540-542
LICHTENBERG Portaghi	497
LICHTENBERG TC Portaghi	530
LICHTWITZ Tre quarti per puntura del seno mascellare	70, 87
Lima per cute ispessita	1207
Lime per unghie	1206
LISTER Candeleterie dilatatrici	950
LISTER Forbici per bendaggi	1187
LISTER Forbici per bendaggi e gessi	1190
LISTER Pinze per seni	352
LISTON Cesioie per ossa	1141-1143
LISTON Coltelli per amputazione	52
LISTON-KEY Cesioie per ossa	1144
LISTON-STILLE Cesioie per ossa	1143
LITTAUER Forbici per legature	147
LITTAUER Pinze per ciglia	223
LITTAUER Pinze per polipi auricolari	732
LITTAUER Pinze per tamponi e polipi nasali	670
LITTLE Divaricatori	438
LITTLER Forbici fine per chirurgia	126
LITTLER Forbici per legature	147
LITTLEWOOD Pinze da presa per intestino e tessuti	365
LLOYD-DAVIES Forbice per dissezione rettale	106
LLOYD-DAVIES Pinze per anastomosi del retto	856
LOCKHART-MUMMERY Sonda	64
LOCKLIN Forbici vascolari	133
LOCKLIN TC Forbici per gengiva	178
LOCKWOOD Pinze da presa per intestino e tessuti	362
LOCKWOOD-ALLIS Pinze da presa per intestino e tessuti	365
Lombare microdissectomia divaricatori Set	583
LOPEZ-REINKE Dissettori per tonsille	622
LORENZ Forbici per bendaggi e gessi	1190
LORNA (EDNA) Pinze fissatele	369
LOUTE Strumenti per cerchiaggio	1158
LOVE Divaricatore per velo pendulo	627
LOVE Separatori pr le radici dei nervi	551, 552, 553
LOVE-GRUENWALD Pinze per laminectomia	996
LOVELACE Pinze per afferrare polmone	801
LOWER Pinze per preparazioni e legature	281
LOWMAN Tenaglie per ossa	1126
LOWMAN-HOGLUND Tenaglie per ossa	1126
LUBET-BARBON Pinze per tamponi e polipi nasali	669
LUC Pinze per setto nasale	697
LUCAE Aghi per paracentesi	737
LUCAE Diapason	713, 714
LUCAE Divaricatori	429
LUCAE Martelli	1016
LUCAE Pinze auricolari e nasali	221, 222
LUCAS Curette per ossa	1091
LUER Cannule tracheali	654
LUER Divaricatori	419
LUER Pinze da presa per intestino e tessuti	366
LUER Pinze per ossa	1128, 1130
LUER Siringhe	74
LUER-FRIEDMANN Pinze per ossa	1127
LUER-KOERTE Cucchiari per calcoli biliari	873

LUER-LOCK Siringhe	74, 76
LUER-STILLE Pinze per ossa	1138, 1139
LUIKART-BILL Fermapinza	936
LUKENS Uncini tracheali	656
LUNIATSCHEK Portatampone	626
LURZ Pinze per calcoli biliari	877
<b>M</b>	
M.G. HOSPITAL Portaghi	489
MAGILL Pinze introduttrici di cateteri	944
MAGILL Tubi aspirazione	79
Maglia metallica	1155
Magnete di barra	822
MAINGOTT Pinze per isterectomia	275
MALTZ Raspe nasali	1085, 1087
Mani di piombo	1182
Manici per bisturi	44-47, 50, 823, 825, 826
Manico a trazione	936
Manico ad uncino per fili per sega	1010
Manico per aspirazione	85
Manico per pila per laringoscopi	42-43
Manico universale	636, 923
MANNERFELT Divaricatori	1178-1180
MANNERFELT Osteotomi	1181
MANNERFELT Periostotomi	1180, 1181
MANNERFELT Sgorbie	1181
Marcatori per areola	21
MARKWALDER Pinze per ossa	1139
MARQUARDT Pinze per ossa	1133
MARSCHIK Pinze per tonsille	620
MARSCHIK-KRONE Pinze per tonsille	621
Martelli	751, 1013-1020
Martelli percussori	16, 17
MARTIN Coltelli per gessi	1195
MARTIN Divaricatori	375, 377
MARTIN Divaricatori	414
MARTIN Forbici per cartilagini	116
MARTIN Isterometri	899
MARTIN Pelvimetro	931
MARTIN Pinze da presa per menisco e cartilagine	1146
MARTIN Pinze per medicazione	351
MARTIN Pinze per rifiuti	1218
MARTIN Portacotone	65
MARTIN Seghe per aprire anelli	1011
MARTIN-CUSHING Periostotomi	1071
MARTINI Curette per ossa	1091
MARTIN-LANGENBECK Periostotomi	1071
MASING Coltelli per scalfire la cartilagine	672
MASING Divaricatori nasali	690
MASING Elevatori per il setto nasale	677
MASING Pinze auricolari	734
MASSON Portaghi	493
MASSON TC Portaghi	527
MASSON-LUETHY Portaghi	494
MASTIN Pinza muscolare	657
MATHIEU Dilatatori per l'ano ed il retto	861
MATHIEU Divaricatori	418
MATHIEU Pinze per corpi estranei	948
MATHIEU Portaghi	496
MATHIEU Speculi vaginali	892
MATHIEU TC Portaghi	528, 529
MATHIEU-RYDER TC Portaghi	534
MATZENAUER Speculi vaginali	892
MAUNDER Apribocca elicoidale	619
MAXIMUS Sfigmomanometri	24
MAYFIELD Pinze per ossa	1132
MAYO Cucchiari per calcoli biliari	874
MAYO Forbici per chirurgia	103, 152
MAYO Pinze per sterilizzazione	372
MAYO SCT Forbici per chirurgia	186
MAYO Spatole per lingua	600
MAYO TC Forbici per chirurgia	165
MAYO TC Forbici per legature	181
MAYO-ADAMS Divaricatori, autostatici	449
MAYO-BLAKE Pinze per calcoli biliari	877
MAYO-GUYON Pinze per peduncoli renali	285
MAYO-HARRINGTON Forbici per chirurgia	105, 153
MAYO-HARRINGTON SCT Forbici per chirurgia	186
MAYO-HARRINGTON TC Forbici per chirurgia	165
MAYO-HEGAR Portaghi	488, 489
MAYO-HEGAR TC Portaghi	521
MAYO-LEXER TC Forbici per dissezione	171
MAYO-NOBLE Forbici per chirurgia	105
MAYO-ROBSON Pinze intestinali	850

MAYO-RUSSIAN Pinze per afferrare tessuti	203	MILLIN Pinze per prendere capsule	955
MAYO-STILLE Forbici per chirurgia	104, 153	MILLS Forbici vascolari	137
MAYO-STILLE SCT Forbici per chirurgia	187	MINI-HOHMANN Leve per ossa	1075
MAYO-STILLE TC Forbici per chirurgia	167	MINI-LAMBOTTE Osteotomi	1030, 1031
MC CLINTOCK Pinze per placenta e per ovaie	940	MINI-LANGENBECK Divaricatori	439
MC CLURE Micro-forbici	138	MINIMUS Sfigmomanometri	24
MC CULLOCH Divaricatori per laminectomi	586, 587	MINI-OLSEN Portaghi con forbici	495
MC DONALD Periostotomi	1055	MINI-ROUX Divaricatori	922
MC GEE Micropinze per piegare fili metallici	741, 744	MINI-TOWNSEND Pinze per la biopsia cervicale e da prelievo	417
MC GEE Uncino	750	Mini-transformatore	27
MC GIVNEY Legatore emorroidale	868	MINI-VANNAS Micro-forbici	138
MC GLAMRY Periostotomi	1068	Miringotomo	735
MC INDOE Divaricatori	443	MISKIOM Divaricatori, autostatici	454
MC INDOE Forbici per cartilagini	115	Misuratori	22
MC INDOE Osteotomi	684	MIXTER Forbici per chirurgia	97
MC INDOE Pinze anatomiche per dissezione	199	MIXTER Pinze per calcoli biliari	878
MC INDOE Pinze per chirurgia	211	MIXTER Pinze per preparazioni e legature	268, 280
MC INDOE TC Pinze anatomiche per dissezione	232	MIXTER-O'SHAUGNESSY Pinze per preparazioni e legature	281
MC INTOSH Laringoscopi	38	MOCK Ago per eparina	73
MC INTOSH Laringoscopi di luce fredda	40	MOELTGENGoniometro	20
MC IVOR Abassalingua	616	MOLDENHAUER Leva auricolare	730
MC IVOR Apribocca	614	MOLDESTAD Divaricatori	433
MC KENTY Elevatori per il setto nasale	676, 677	MOLLISON Divaricatori, autostatici	447
MC KENZIE Agrafes di argento	546	MOLT Apribocca	603
MC KENZIE Pinze per applicare le agrafe	547	MOLT Periostotomi	1054
MC KENZIE Supporto porta-agrafes	546	MOORE Cucchiato per colecisti	873
MC KESSON Apribocca elicoidale	619	MOORE Trapani a mano per ossa	1171
MC QUIGG-MIXTER Pinze vascolari atraumatiche	300	MOORFIELD Pinze per sutura	198
MEAD Martelli	1013	MORGAN Proctoscopi	864
MEAD Pinze per ossa	1130	MORITZ-SCHMIDT Abassalingua	601
Meatotomo	948	MORRIS Divaricatori	401
MEEKER Pinze per preparazioni e legature	266	MORRIS-DE BAKEY Pinze vascolari atraumatiche	324
MEMORY Spatole cerebrali	544	MORSE Divaricatori costali	775, 778, 779
MENGHINI Aghi per la puntura cieca del fegato	74	MORSE-FAVALORO Divaricatori costali	778
MERCEDES Divaricatori costali	790	MOSHER-BRUENINGS Tubo di intubazione	653
Metro a nastro	21	MOSQUITO-DANDY Pinze emostatiche	248
METZENBAUM Forbici per dissezione	108-111, 154	MOYNIHAN Pinze per isterectomia	273
METZENBAUM Portaghi	489	MOYNIHAN Sonde per calcoli biliari	872
METZENBAUM SCT Forbici per dissezione	187, 188	MUCK Coltello periostio	735
METZENBAUM TC Forbici per dissezione	167-170	MUEHLING Periostotomi	562
METZENBAUM TC Forbici per legature	181	MUELLER Divaricatori, autostatici	445
METZENBAUM-BABY Forbici per dissezione	111, 155	MUELLER Pinze per anastomosi del retto	858
METZENBAUM-LAHEY TC Forbici per dissezione	173	MUENCHEN Curette per biopsia	913
MEYER Pinze per riposizioni	1116	MURPHY Fascia frontale	35
MEYERDING Divaricatori	407, 441, 486	MURPHY-LANE Leva per lussazione	1083
MEYERDING Divaricatori, autostatici	452	MUSEUX Pinze per abbassare il collo dell'utero	905, 906, 908
MICHEL Agrafe da sutura	516	MUSGROVE Ago per cerume e portagarze	730
MICHEL Pinze per applicare le agrafe	517	MYLES Pinze nasali	990
MICHEL Specchi per rinoscopia	632	<b>N</b>	
MICK Forbici per bendaggi e gessi	1188, 1189	NABATOFF Set di sonde per varici	806
MICRO-ADSON Pinze emostatiche	245	NAEGELE Pinza obsterica	932
Microaghi	748, 749, 752, 753	NAGER Divaricatore per velo pendulo	627
Microbisturi	745	NEFF Bisturi per menisco	1146
Microchirurgia endolaringea	642-651	NEGUS (GUEDEL) Laringoscopi	36
Micro-dissettore	814	NEGUS Coltelli per vegetazioni adenoidee	629
Micro-forbici	138-143	NEGUS Pinze per peduncoli renali	282
Microforbici da presa	644, 646, 651	NEGUS Supporto sternale per tutti gli apribocca	617
MICRO-MOSQUITO Pinze emostatiche	250, 259	NEIVERT Portaghi	491
Micro-pinze	226-228	NEIVERT Uncino per ali nasali	690
Micropinze a cucchiaino	642, 647-651	NEIVERT-ANDERSON Osteotomi	683
Micropinze con morsi a cucchiaino	739, 743	NEIVERT-MASING TC Portaghi	524
Micropinze da presa	642-643, 646, 649-651	NÉLATON Sonde scanalate	63
Micropinze per piegare fili metallici	741, 742, 744	NELSON Pinze per afferrare polmone	216
Microportaghi	643, 644	NELSON Tre quarti	69
MICRO-RYDER TC Portaghi	532	Neurochirurgia	537-594
Microuncini	749	NEW ORLEANS TC Portaghi	526
MICRO-VASCULAR TC Portaghi	532	NEWS Uncini tracheali	656
MIDDELDORPF Divaricatori	400	Nexessario per infermiera	1207
MIDDLETON-JANSEN Pinze per setto nasale	699	NICOLA Curetta	704
MIKULICZ Divaricatori	392, 393	NICOLA Microforbici da presa	651
MIKULICZ Pinze per peritoneo	277-279	NICOLA Micropinze a cucchiaino	651
MILAN Curette per biopsia	914	NICOLA Periostotomo	704
MILIGAN Divaricatori, autostatici	449	NIEDERDELLMANN Osteotomi	1038
MILLARD (COTTLE) Uncino nasale ad anello	689	NISSEN Pinze emostatiche	243
MILLER Curette per ossa	1092	NORFOLK & NORWICH Divaricatori, autostatici	453
MILLER Laringoscopi	37	NOTO Pinze per polipi e ovaie	357
MILLER Laringoscopi di luce fredda	41	NOTT Speculi vaginali	883
MILLER Raspe nasali	1087	NOVAK Curette per biopsia	912
MILLER-COLBURN Curette per ossa	1094	NOYES Micro-forbici	140
MILLER-COLBURN Raspe nasali	1088	NUBOER Tubi aspirazione	78
MILLIGAN Dissettori per la dura-madre	550	NUSSBAUM Pinze intestinali	849
MILLIN Dilatatore per collo vescicale	953	<b>O</b>	
MILLIN Divaricatori vescicali	952	O'BRIEN Forbici fine per chirurgia	128





OBWEGESER Aghi per legatura	501
OBWEGESER Divaricatori per tessuti molli	384, 385
OBWEGESER Elevatori	1056
OBWEGESER Guancio per mento	383, 1057
OBWEGESER Osteotomi	1035, 1036
OBWEGESER Osteotomi a forma di cuneo	1035
OBWEGESER Osteotomi a forma di lama	1035
OBWEGESER Osteotomi fenditori	1035
OBWEGESER Osteotomi interdentai	1036
OBWEGESER Periostotomi	1058, 1059
OBWEGESER Raspe	1088
OBWEGESER Separadore per il dente del giudizio	387
OBWEGESER Separatore per ramo	386
OBWEGESER Separatori mandibulari	1057
OCHSNER Pinze anatomiche per dissezione	203
OCHSNER Pinze vascolari atraumatiche	331
OCHSNER Sonde per calcoli biliari	873
OCHSNER Tre quarti per vescia biliare	71
OCHSNER-KOCHER Pinze emostatiche	252, 253
O'CONNOR Divaricatori	431
OKONEK-YASARGIL Punzone per tumore	828
OLDBERG Pinze per laminectomia	1005
OLIVECRONA Bisturi per nervo trigemino	57
OLIVECRONA Dissettori per la dura-madre	550
OLIVECRONA Fili per sega	1010
OLIVECRONA Forbici nasali	120
OLIVECRONA Pinze per ossa	1131
OLIVECRONA Spatole cerebrali	544
OLIVECRONA-TOENNIS Pinze per applicare le agrafe	547
OLLIER Divaricatori	380
OLSEN-HEGAR Portaghi con forbici	495
OLSEN-HEGAR TC Portaghi	527
OMBREDANNE Martelli	1015
O'SHAUGNESSY Pinze per preparazioni e legature	281
Osteotomi	680-684, 1021, 1026-1051
Osteotomi a forma di cuneo	1035
Osteotomi a forma di lama	1035
Osteotomi fenditori	1035
Osteotomi interdentai	1036
O'SULLIVAN - O'CONNOR Speculi vaginali	895
O'SULLIVAN-O'CONNOR Divaricatori addominali	476
OTIS Uretrotomo	954
Otoscopi	599, 712
OVERHOLT Pinze per preparazioni e legature	261, 262
OVERHOLT-GEISSENDOERFER Pinze per preparazioni e legature	260
OVERHOLT-MIXTER Pinze per preparazioni e legature	268
<b>P</b>	
PACHON Stigmomanometri	24
Padelle	1215
PAPAVERO-CASPAR Speculi per ipofisi sectomia	702
PARKER Divaricatori	417
PARKER-BABY Divaricatori	417
PARKER-KERR Pinze per anastomosi del retto	855
PARKER-LANGENBECK Divaricatori	418
PARKER-MOTT Divaricatori	418
PARKS Raspe nasali	1087
PARTSCH Martelli	1017
PARTSCH Scalpelli	1027
PARTSCH Sgorbie	1028
PARTSCH-LANGE Periostotomi	1052
PASSOW Punzoni	1024
PAUL Divaricatori	444
PAYR Pinze intestinali	854
PAYR Sonde conduttrici	512
PEAN Pinze emostatiche	238-241
PECK-JOSEPH Forbici fine per chirurgia	123
PEDERSON Speculi vaginali	883, 884
PEERS-BERTRAM Pinze fissatele	369
PEET Pinze per scheggio	1208
PELKMANN Pinze per medicazione	355
PELTESON Portacotone	633
Pelvimetro	931
PENFIELD Dissettori per la dura-madre	812
PENNINGTON Elevatori per il setto nasale	676
PENNINGTON Pinze da presa per intestino e tessuti	362
PENNYBACKER Pinze per laminectomia	1004
PENNYBACKER Pinze per ossa	1131
PENNYBAKER Dissettori per la dura-madre	813
PERCY Retrattore per amputazione	1008
Perforatori	748
Perforatori a mano	1156, 1157
Perforatori per aorta	811
Periostotomi	562, 563, 704, 708, 752, 831, 832, 835, 1052-1055,

PERKINS Divaricatori, autostatici	1058-1071
PERTHES Puteruoli	448
PESTALOZZA Cucchiari per placenta e per ovaie	1012
PETZ Pinze per intestino e stomaco	942
PHANEUF Pinze per isterectomia	860
PIERCE Elevatori per il setto nasale	273
PIERCE Tre quarti per puntura del seno mammellare	676
Pietra per affilare	70
PINARD Stetoscopi fetali	58
Pinza da presa per gozzo	17
Pinza di fissaggio	657
Pinza di inserimento valve atriali	686
Pinza divaricatore per speculum	820
Pinza emostatiche	702
Pinza muscolare	936
Pinza obsterica	657
Pinza per afferrare la pelle	932-935
Pinza per applicare le pinze bulldog	686
Pinza per columella	293, 296
Pinza per formare osso	686
Pinza per il cuoio cappelluto	1118
Pinza per introduzione per protesi in teflon	936
Pinza per rotula	742
Pinza per trazione craniale	1117
Pinza vascolare e per tumori	548
Pinze	214, 216, 218
Pinze anastomosi	194-229
Pinze anatomiche per dissezione	845
Pinze atraumatiche	194-204
Pinze auricolari	218-220
Pinze auricolari e nasali	732-734
Pinze con morsi in carburo di tungsteno	221, 222
Pinze da presa	232-236
Pinze da presa per intestino e tessuti	204
Pinze da presa per lingua	360-366
Pinze da presa per menisco e cartilagine	618
Pinze emostatiche	1145, 1146
Pinze fissatele	238-260
Pinze guida sonda	367-369
Pinze intestinali	1012
Pinze introduttrici di cateteri	844-854
Pinze microauricolari	944
Pinze nasali	739, 743
Pinze nasali per biopsia	756-760, 988-994
Pinze naso-faringe	755
Pinze orologio	631
Pinze passa tendine	228
Pinze per abbassare il collo dell'utero	1150-1152
Pinze per afferrare	901-908
Pinze per afferrare e rompere le lamette de rasoio	47
Pinze per afferrare l'utero	825
Pinze per afferrare organi	909, 910
Pinze per afferrare polmone	358
Pinze per afferrare tessuti	216, 801
Pinze per allacciare tendini	203, 204, 209, 217
Pinze per anastomosi del retto	1150-1152
Pinze per applicare le agrafe	855-859
Pinze per ascessi tonsillari	517, 518
Pinze per biopsia rettale	623
Pinze per bronchi	869
Pinze per Broncho-esofagoscopia	802
Pinze per calcoli	636
Pinze per calcoli biliari	945
Pinze per calcoli renali	877, 878
Pinze per chirurgia	875
Pinze per ciglia	205-218
Pinze per corpi estranei	223
Pinze per etmoide	731, 948
Pinze per fissare	745
Pinze per frammento osseo	946
Pinze per intestino e stomaco	1118
Pinze per iridectomia	860
Pinze per isterectomia	197, 208
Pinze per la biopsia cervicale e da prelievo	271-276, 286
Pinze per la testa del martelletto	916-923
Pinze per laminectomia	742, 744
Pinze per laminectomia, smontabile	958-987, 994-1007
Pinze per malleolo	962, 966
Pinze per medicazione	1117
Pinze per mettere clips ETHICON	349-355
Pinze per nefrostomia	518
Pinze per ossa	874, 876
Pinze per ossa del cranio	1126-1140

Pinze per peduncoli renali	549	Protettore per dita	862, 864
Pinze per peritoneo	282-284	<b>PROVIDENCE-HOSPITAL</b> Pinze emostatiche	619
Pinze per placenta e per ovaie	277-279	Punzone per sutura	249
Pinze per polipi auricolari	939-941	Punzone per tumore	827, 828
Pinze per polipi e ovaie	732	Punzoni	828
Pinze per polipi laringei	356, 357	Puteruoli	1024
Pinze per prendere capsule	634, 635	<b>PUTTI</b> Raspe	1012
Pinze per preparazioni e legature	955	<b>Q</b>	
Pinze per rifiuti	260-270, 280-281	<b>QUATTRO</b> Apri gesso	1089
Pinze per riposizioni	1218	<b>QUERVAIN</b> Elevatori	1194
Pinze per rompere le lamette de rasoio	1115	<b>QUINBY</b> Forbici per gengiva	1074
Pinze per schegge	47	<b>QUINKE</b> Aghi per la puntura cieca del fegato	124
Pinze per scheggno	224-225	<b>QUIRE</b> Leva per corpi estranei	74
Pinze per seni	1208	<b>R</b>	
Pinze per seno frontale	352	<b>RABINER</b> Martelli percussori	731
Pinze per setto nasale	695	<b>RADOLF</b> Tronchesini per unghie	17
Pinze per sterilizzazione	696-699, 701	<b>RAGNELL</b> Divaricatori	1206
Pinze per strumenti sterilizzati	372	<b>RAGNELL-DAVIS</b> Divaricatori	419
Pinze per sutura	1209	<b>RAKE</b> Divaricatori	440
Pinze per tamponi	198	<b>RALK</b> Pinze per scheggno	486
Pinze per tamponi e polipi nasali	349-352, 354, 355	<b>RALK</b> Trapani a mano per ossa	1208
Pinze per tamponi e spugne	669, 670	<b>RAMPLEY</b> Pinze per tamponi e spugne	1172, 1173
Pinze per tonsille	359	<b>RANDALL</b> Curette per biopsia	359
Pinze per uretere	620	<b>RANDALL</b> Pinze per calcoli renali	912
Pinze per vena cava	945	<b>RANDALL</b> Pinze per nefrostomia	875
Pinze per vomere	347, 348	<b>RANEY</b> Agrafe emostatici per cuoio capelluto	876
Pinze porta cavo	696, 697	<b>RANEY</b> Pinze per applicare le agrafe	546
Pinze porta-lamelle	1159-1163	Raschiatoio per lupus	546
Pinze rotanti taglienti	226	Rasoi	60
Pinze serratubi	756	Raspe	58
Pinze stomaco	370-371	Raspe nasali	748, 1088, 1089
Pinze taglienti per seno mascellare	851	<b>RAY</b> Curetta	1084-1090
Pinze vascolari atraumatiche	693-695	<b>RECAMIER</b> Curette uterine	703
Pinze vascolari per neonati	299-346	Recipienti	925, 926, 928
Pinze zecca	298-299	<b>REDON</b> Aghi conduttori	1212-1217
<b>PIPER</b> Pinza obsterica	226	<b>REICHERT</b> Abasso epiglottide	66-68
Pistola lavatrice a getto d'acqua	934	<b>REILL</b> Pinze per riposizioni	633
<b>PITHA</b> Apribocca elicoidale	1226	<b>REILL</b> Tenaglie tagliafilili	1116
<b>PITHA</b> Pinze per medicazione	619	<b>REINER</b> Coltelli per gessi	1164
Placca per stendere la pelle	352	<b>RESANO</b> Forbice per capsula	1195
<b>PLESTER</b> Bisturi a falda	59	<b>RESANO</b> Pinze per anastomosi del retto	105
<b>PLESTER</b> Bisturi falciforme	745	Retratore per amputazione	859
<b>PLESTER</b> Divaricatori, autostatici	745	Retrattori per ginocchio	1008
<b>PLESTER</b> Escavatore	448	Retrattori prostatici	1148, 1149
<b>PLESTER</b> Forcella di guida	747	<b>REVERDIN</b> Aghi per legatura	953
<b>PLESTER</b> Raspa	747	<b>REVERDIN</b> Spatole addominali e intestinali	500
<b>PLESTER</b> Tubi aspirazione	748	<b>REYNOLDS</b> Forbici per dissezione	421
<b>PLESTER</b> Uncino	77	<b>REYNOLDS</b> SCT Forbici per dissezione	114, 156
<b>PLESTER</b> Uncino per seno mascellare	747	<b>REYNOLDS</b> TC Forbici per dissezione	189
<b>POLITZER</b> Aghi per paracentesi	747, 748	<b>RHOTON</b> Aghi	172, 173
<b>POLITZER</b> Bisturi per foruncoli	736	<b>RHOTON</b> Curetta	841
<b>POLITZER</b> Insoffiatore d'aria	735	<b>RHOTON</b> Dissetto	840, 841
<b>POLITZER</b> Specoli auricolari	716, 717	<b>RHOTON</b> Dissettori sferici	840
<b>POLLOSON</b> Divaricatori	721	<b>RHOTON</b> Elevatori	840
Polverizzatori	410	<b>RHOTON</b> Uncino	840
<b>POOLE</b> Tubi aspirazione	761	<b>RIBBON-IRIS</b> Forbici fine per chirurgia	841
<b>POPLITEA</b> Divaricatori addominali	82, 83	<b>RIBBON-STEVENS</b> Forbici fine per chirurgia	130
Portacotone	465	<b>RICARD</b> Divaricatori addominali	130
Portaghi	65, 66, 633, 653	<b>RICHARDSON</b> Divaricatori	468
Portaghi con forbici	488-499	<b>RICHARDSON-EASTMAN</b> Divaricatori	412
Portaghi con morsi in carburo di tungsteno	495	<b>RICHNAU-HOLMGREN</b> Specoli auricolari	411
Portalegature	520-535	<b>RICHTER</b> Forbici per chirurgia	726
Portapinze	513, 627, 815, 822	<b>RICHTER-HEATH</b> Pinze per applicare le agrafe	97
Portatampone	845	<b>RIENHOFF</b> Divaricatori costali	518
<b>POTTS</b> Pinze vascolari atraumatiche	626	<b>RIGBY</b> Divaricatori, autostatici	782
<b>POTTS-DE MARTEL</b> Forbici vascolari	307, 308, 315, 319, 320	Righello del suturare	458
<b>POTTS-DE MARTEL</b> SCT Forbici vascolari	136	<b>RING</b> Abassalingua	823
<b>POTTS-SMITH</b> Forbici vascolari	192	<b>RI-RAP</b> Stetoscopi	616
<b>POTTS-SMITH</b> Pinze anatomiche per dissezione	117, 133, 136, 158	<b>RITTER</b> Dilatatori per seno frontale	19
<b>POTTS-SMITH</b> Pinze per chirurgia	201	<b>ROBB</b> Dissettori vascolari	753
<b>POTTS-SMITH</b> TC Pinze anatomiche per dissezione	213	<b>ROBERTS</b> Pinze per preparazioni e legature	814
<b>POTTS-SMITH</b> TC Forbici vascolari	233	<b>ROBIN MASSE</b> Divaricatori addominali	269
<b>POZZI</b> Pinze per abbassare il collo dell'utero	179	<b>ROBIN</b> Pinze fissatele	465
<b>PRATT</b> Curette per seno mascellare	902	<b>ROCHARD</b> Divaricatori addominali	367
<b>PRATT</b> Dilatatori per l'ano ed il retto	690	<b>ROCHESTER-CARMALT</b> Pinze emostatiche	477
<b>PRATT</b> Pinze per abbassare il collo dell'utero	861	<b>ROEDER</b> Pinze fissatele	245
<b>PRATT</b> Pinze per peritoneo	907	<b>ROEDER</b> Serranodi per tonsille	368
<b>PRATT</b> Sonde	277	<b>ROETTGEN-RUSKIN</b> Pinze per ossa	627
<b>PRECISA</b> Sfigmomanometri	64	<b>ROGER</b> Elevatori per il setto nasale	1134
<b>PRINCE</b> Forbici per tonsille	24	<b>ROGERS</b> Pinze per isterectomia	676
<b>PRINCE-THOMAS</b> Pinze per afferrare polmone	116	<b>ROGGE</b> Pinze per strumenti sterilizzati	275, 276
<b>PRINCE-THOMAS</b> Pinze per bronchi	801	<b>ROLLET</b> Divaricatori	1209
Proctoscopi	802	<b>ROSCHKE</b> Dilatatori per l'ano ed il retto	432



ROSE Divaricatori	864	SCHNEIDER-SAUERBRUCH Periostotomi	1064
ROSEN Bisturi lanceolato	419	SCHNIDT Pinze emostatiche	1065
ROSEN Bisturi rotondi	747	SCHNIDT Pinze per tonsille	244
ROSEN Cucchiaio	746	SCHOEMAKER Pinze intestinali	620
ROSEN Gancio fenestrato	747	SCHOEMAKER-LOTH Forbici per legature	852
ROSEN Microaghi	747	SCHOENBORN Uncini tracheali	147
ROSEN Periostotomo	748, 749	SCHROEDER Bisturi per fistole	656
ROSEN Tubi aspirazione	747	SCHROEDER Curette uterine	56
ROSER-KOENIG Apribocca	85	SCHROEDER Pinze per abbassare il collo dell'utero	924
ROSS Divaricatori per aorta	604	SCHUBERT Pinze per la biopsia cervicale e da prelievo	901, 903, 907
ROUX Divaricatori	816	SCHUHKNIGHT Strumento curvo per modellare fili guida	916, 917
ROUX-MAGNUS Divaricatori	416	SCHUHKNIGHT Tubi aspirazione	686
RUBIN Osteotomi	417	SCHUHKNIGHT Bisturi a rullo	89
RUBIN Pinze per setto nasale	681	SCHUHKNIGHT Bisturi falciforme	746
RUDD Legatore emorroidale	701	SCHUHKNIGHT Micropinze per piegare fili metallici	746
RUMEL Pinze per preparazioni e legature	867	SCHUL Divaricatori per disco intervertebrale	741
RUMEL-BELMONT Porta-legatur	267	SCHULTZE Salpingografo	594
RUMEL-BELMONT Strumenti per varici	815	SCHUMACHER Costotomi	915
RUSKIN Pinze per ossa	815	SCHUMACHER Forbici ombelicali	764
RUSKIN Tre quarti per puntura del seno mascellare	1133	SCHUMACHER Pinze per Broncho-esofagoscopia	102
RUSKIN-LISTON Cesoie per ossa	87	SCHUMACHER Pinze per la biopsia cervicale e da prelievo	637
RUSSEL-DAVIS Abassalingua	1142	SCHUMACHER-VAN DOREN Pinze per la biopsia cervicale e da prelievo	920
RUSSIAN Pinze per afferrare tessuti	615	SCHWEDEN Curette per ossa	918
RUST Seghe per amputazione e resezione	203	Scodella di Petri	1091
RYDEL-SEIFFER Diapason	1009	Scodelle rotonde	1214
RYDER Portaghi	713	SCOVILLE Curette per ossa	1212, 1214
RYDER-VASCULAR TC Portaghi	498	SCOVILLE Divaricatori	1106
<b>S</b>		SCOVILLE Divaricatori per laminectomi	486
SAALFELD Tiracomedoni	532	SCOVILLE Separatori per le radici dei nervi	558
SACHS Dissettori per la dura-madre	61	SCOVILLE Valve laterale	552
SACHS Uncini per dura-madre	550, 551	SCOVILLE-HAVERFIELD Divaricatori per laminectomi	557, 558
SACHSE Meatotomo	554	SCOVILLE-RICHTER Divaricatori per laminectomi	557
SAENGER Pinze per placenta e per ovaie	948	SCOVILLE-RICHTER Valve laterale	556
SALENIUS Bisturi per menisco	941	SCT Forbici da utero	565
Salpingografo	1146	SCT Forbici fine per chirurgia	186
SALYER Forbici per Face-lift	915	SCT Forbici nasali	190
SAMII Bisturi a lancetta	118	SCT Forbici per chirurgia	189, 190
SAMII Lama del tumore	837	SCT Forbici per dissezione	186, 187
SANTULLI Clamps Bulldog	836, 837	SCT Forbici per Face-lift	187
SANVENERO Forbici fine per chirurgia	296	SCT Forbici vascolari	190
SAROT Pinze per preparazioni e legature	124	SCUDDER Pinze stomaco	191
SAROT Portaghi	267	SEBILLEAU Elevatori	851
SAROT TC Portaghi	490	SEDILLOT Periostotomi	1074
SATINSKY Forbici vascolari	524	SEEMANN-SEIFERT Apribocca	1063, 1065
SATINSKY Pinze per vena cava	131	Seghe elettrica oscillante per autopsia	605
SATINSKY Pinze vascolari atraumatiche	347, 348	Seghe elettriche oscillanti per gesso	1022, 1023
SATTERLEE Seghe per amputazione e resezione	332	Seghe nasali	1196-1199
SAUERBRUCH Costotomi	1010	Seghe per amputazione e resezione	685
SAUERBRUCH Divaricatori	765	Seghe per aprire anelli	1009, 1010
SAUERBRUCH Pinze per rifiuti	382, 394	Seghe per gessi	1011
SAUERBRUCH Scatole per aghi	1218	SEGOND Bisturi per fibromi	1195
SAUERBRUCH-CORYLLOS Pinze per ossa	1223	SEGOND-LANDAU Pinze per isterectomia	56
SAUERBRUCH-FREY Costotomi	1140	SEIDL Speculi vaginali	273
SAUNDERS Strumento per la rimozione dell I.U.D.	767	SEIFFERT Pinze per Broncho-esofagoscopia	887
SAWTELL Pinze per tonsille	911	SELDIN Periostotomi	637
SCALP-CONTOUR Divaricatori, autostatici	620	SELLHEIM Leva ostetrica	1064
ScalPELLI	446	SELLORS Approssimatori costali	936
Scalpello per sterno	680-682, 751, 1025-1051	SELMANN Pinze da presa	800
Scatole per aghi	764	SELVERSTONE Pinze per laminectomia	204
Scatole per magazzino	1222, 1223	SEMB Cesoie per ossa	998, 999
Scatole per sterilizzare bendaggi	1225	SEMB Periostotomi	1144
Scatole per strumenti	1224	SEMB Pinze per bronchi	1066
SCHAEDEL Pinze fissatele	1216, 1217	SEMB Pinze per ossa	802
SCHAMBERG Tiracomedoni	368	SEMB Tenaglie per ossa	1139
SCHAEDE Curette per ossa	61	SEMKEN Pinze anatomiche per dissezione	1119
SCHAEIBE Pinze da presa per intestino e tessuti	1095	SEMKEN Pinze per chirurgia	199, 200
SCHHEINMANN Pinze per Broncho-esofagoscopia	362	SEMKEN TC Pinze anatomiche per dissezione	208, 212
SCHERBACK Speculi vaginali	637	SEMKEN TC Pinze per chirurgia	232
SCHIMMELBUSCH Scatole per sterilizzare bendaggi	894	SEMM Divaricatori addominali	234, 235
SCHINDLER Pinze per peritoneo	1224	SEMM Speculi vaginali	474
SCHINK Dermotomi	279	SENN-GREEN Divaricatori	882
SCHINK Placca per stendere la pelle	59	SENNING TC Portaghi	438
SCHIOETZ Tonometro	59	SENN-MILLER Divaricatori	523
SCHLESINGER Pinze per laminectomia	23	Separatore per il dente del giudizio	439
SCHMEDEN Pinze nasali	1006	Separatore per il corpo mandibulare	387
SCHMID Cannula per irrigazione vascolare	992	Separatore per ramo	1057
SCHMID Spatola per intima	73	Separatori mandibulari	386
SCHMIEDEN Aghi per legatura	813	Separatori per guancia	1057
SCHMIEDEN Sonda conduttrici	502	Separatori per labbra e guancia	619
SCHMIEDEN-DICK Aghi per legatura	511	Separatori per vertebre	618
SCHMIEDEN-PAYR Sonda conduttrici	501	Separatori per le radici dei nervi	592, 593
SCHMIEDEN-TAYLOR Forbici vascolari	511	Separatore per il borde anteriore	551-553
SCHNEIDER Periostotomi	133	Serranodi auricolari	1057

Serranodi per laringologia	738	Spatole addominali e intestinali	813, 814
Serranodi per polipi	652	Spatole cerebrali	421
Serranodi per tonsille	671	Spatole per impiastro	543, 544
Serrapene	623, 624, 627	Spatole per lingua	66
Serrapinze	946	Spatole per pulmone	600
Serrapinze e portapinze	845	Spatole vescicali	800, 801
Set di sonde per varici	860	Spazzola per unghie	953
Set per autopsia	806, 807	Spazzole per pulire	1227
Set per diagnostica	1021	Specchi laringei	1227
Set per tunnelare	30-35	Specchi per rinoscopia	632
<b>SEUTIN</b> Forbici per bendaggi e gessi	811	Specchio frontale	632
<b>SEWALL</b> Periostotomi	1191	Speculi auricolari	35
<b>SEWALL</b> Periostotomi	1052	Speculi nasali	720-726
<b>SEXTON</b> Aghi per paracentesi	1060	Speculi per chirurgia lombo vertebrale	660-668
<b>SEYFFERT</b> Speculi vaginali	735	Speculi per ipofisi sectomia	585
Sfigmomanometri	882	Speculi rettali	702
Sfinteroscopi	24-25	Speculi vaginali	861, 862
Sgorbia	863	<b>SPENCER-WELLS</b> Pinze emostatiche	880-895
Sgorbie per tessuto osseo spugnoso	751, 679, 1025-1051	Spezzacrani	242
Sgorbie spinali	1045	<b>SPRATT</b> Curette per ossa	937
<b>SHAAF</b> Pinze per ciglia	1050	<b>SPREADY</b> Divaricatori per laminectomi	1097
<b>SHAMBAUGH</b> Microuncini	223	<b>SPURLING</b> Pinze per laminectomia	589-591
<b>SHAMBOUGH</b> Adenotomi	749	Sputacchiera	997
<b>SHAPLEIGH</b> Anse auricolari	630	<b>ST. CLAIR-THOMSON</b> Coltelli per vegetazioni adenoidee	1214
<b>SHEA</b> Cucchia taglienti	729	<b>ST. MARKS</b> Dilatatori per l'ano ed il retto	629
<b>SHEEHAN</b> Osteotomi	751	<b>ST. MARKS</b> Divaricatori	866
<b>SIEGLE</b> Lenti auricolari	682	<b>STACKE</b> Sonde buttonute	420
<b>SILVER</b> Dermotomi	726	<b>STANDARD</b> Trequarti	62
<b>SILVER</b> Osteotomi	59	<b>STAUDE-MOORE</b> Pinze per abbassare il collo dell'utero	69
<b>SIMON</b> Bisturi per fistole	683	<b>STEINBACH</b> Martelli	901
<b>SIMON</b> Curette per ossa	56	<b>STELLA</b> TC Forbici per Face-lift	1018
<b>SIMON</b> Divaricatori	1100	<b>STELLBRINK</b> Pinze per ossa	175
<b>SIMPLEX</b> Separatori per guancia	415, 436	<b>STELZNER</b> Forbice per dissezione rettale	1127
<b>SIMPSON</b> Pinza obsterica	619	<b>STERNBERG</b> Separatori per labbra e guancia	107
<b>SIMPSON-LUIKART</b> Pinza obsterica	932, 933	Stetoscopi	618
<b>SIMS</b> Curette uterine	934	Stetoscopi fetali	17-19
<b>SIMS</b> Depressori uterini	900, 927, 930	<b>STEVENS</b> Forbici fine per chirurgia	17
<b>SIMS</b> Dilatatori per l'ano ed il retto	900	<b>STEVENS</b> Pinze per iridectomia	127, 156
<b>SIMS</b> Forbici da uteroa	861	<b>STEVENS</b> SCT Forbici fine per chirurgia	197, 208
<b>SIMS</b> Isterometri	98, 99, 151	<b>STIEGLITZ</b> Pinze per scheggio	191
<b>SIMS</b> SCT Forbici da uteroa	899	Stilette per canale lacrimale	1208
<b>SIMS</b> Speculi rettali	186	<b>STILLE</b> Forbici per gessi	62, 63
<b>SIMS</b> Speculi vaginali	862	<b>STILLE</b> Osteotomi	1192
<b>SIMS</b> TC Forbici da uteroa	887	<b>STILLE</b> Pinze anatomiche per dissezione	1032
<b>SIMS-BODENHAMMER</b> Dilatatori per l'ano ed il retto	163, 164	<b>STILLE</b> Pinze per calcoli biliari	197
<b>SIMS-MAIER</b> Pinze per medicazione	861	<b>STILLE</b> Pinze per chirurgia	878
<b>SIMS-SIEBOLD</b> Forbici da uteroa	355	<b>STILLE</b> Pinze per ossa	207
<b>SINGLEY-TUTTLE</b> Pinze per afferrare tessuti	100, 152	<b>STILLE</b> Pinze per peduncoli renali	1136
Sinuscopi	204	<b>STILLE</b> Scalpelli	283, 285
Siringa per laringei	599, 712	<b>STILLE</b> Sgorbie	1032
Siringhe	76	<b>STILLE</b> Trapani a mano per ossa	1033
Siringhe auricolari	74-76	<b>STILLE-BARRAYA</b> Pinza vascolare e per tumori	1171
Siringhe per aria	719	<b>STILLE-RUSKIN</b> Pinze per ossa	216
Sistema braccio	75	<b>STILLE-SHERMAN</b> Trapani a mano per ossa	1138
Sistema distrattore per il corpo vertebrale cervicale	478, 479	<b>STOCKMANN</b> Pinze per fissare	1171
<b>SKENE</b> Pinze per abbassare il collo dell'utero	560, 561	<b>STOCKMANN</b> Serrapene	946
<b>SLUDER-BALLENGER</b> Tonsillotomi	903	<b>STONE</b> Pinze per chirurgia	946
<b>SMELLIE</b> Spezzacrani	625	<b>STONE-WATT</b> Pinze per intestino e stomaco	218
<b>SMELLIE</b> Unico per detroncazione	937	<b>STONE-WATT</b> Serrapinze e portapinze	860
<b>SMILLIE</b> Bisturi per menisco	937	<b>STRABISMUS</b> Forbici per dissezione	860
<b>SMILLIE</b> Retrattori per ginocchio	1147	<b>STRANDELL-STILLE</b> Divaricatori	112
<b>SMITH</b> Forbici per bendaggi	1148	<b>STRASSBURG</b> Pinze per chirurgia	441
<b>SMITH</b> TC Forbici taglia cavo	1186	<b>STRATTE</b> Portaghi	212
<b>SMITH-BUIE</b> Dilatatori per l'ano ed il retto	180	<b>STRATTE</b> TC Portaghi	492
<b>SMITH-PETERSEN</b> Osteotomi	864	<b>STRAUSS</b> Serrapene	526
<b>SMITH-PETERSEN</b> Pinze per ossa	1039	Stripper anello	946
<b>SMITH-PETERSEN</b> Sgorbie	1134	<b>STRONG (COBRA)</b> Pinze vascolari atraumatiche	808
<b>SMITHWICK</b> Uncini per dura-madre	1040	<b>STRUCK</b> Divaricatori costali	318
<b>SNELLEN</b> Anse auricolari	554	<b>STRUEMPEL</b> Pinze auricolari	782
<b>SOMER</b> Pinze per afferrare l'utero	728	<b>STRULLY</b> Forbici vascolari	734
Sond doppia	909	Strumentario per corpi estranei	131
Sonda bottonuta	827	Strumentario per microchirurgia	731
Sonda con indicatore	827, 828	Strumenti curvi	745-753
Sonda per gozzo	748	Strumenti per aspirazione e irrigazione	1170
Sonde	657	Strumenti per cerchiaggio	86-89
Sonde a foglia di mirto	62-64	Strumenti per chirurgia a cuore aperto	1158
Sonde auricolari	62	Strumenti per circoncisione	824
Sonde buttonute	716	Strumenti per esaminare e misurare	956
Sonde conduttrici	62	Strumenti per introdurre cateteri	20-22
Sonde per calcoli biliari	509-513	Strumenti per mettere i punti	947
Sonde rettali	872, 873	Strumenti per microchirurgia	546, 547
Sonde scanalate	866	Strumenti per miniinvasiva chirurgia	827-841
Spatola per intima	63	Strumenti per ORL	818-823



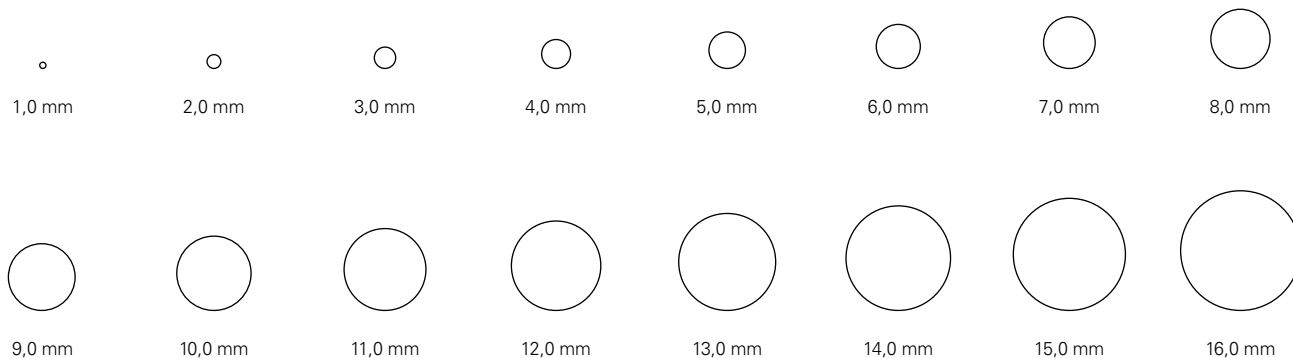


Strumenti per sinusopia	495-761	TOENNIS-ADSON SCT Forbici per dissezione	115
Strumenti per varici	703-708	TOENNIS-ADSON TC Forbici per dissezione	189
Strumento per la rimozione dell I.U.D.	815	TOHOKU Pinze fissatele	173
STRUYKEN Pinze nasali	911	Tonometro	369
SUBRAMANIAN Pinze vascolari atraumatiche	990	Tonsillotomi	23
Succhielli per fibroma	299	Torchio per cartilagine	625
Supporto per gli apribocca	908	TOWNLEY Calibro	686
Supporto per sterilizzazione e conservazione	617	TOYNBEE Specoli auricolari	22
Supporto per strumenti Rhodon	1225	Transformatore	725
Supporto petto	839	Trapani a mano per ossa	27, 42, 43
Supporto porta-agrafes	638	Trapano per seno mascellare	1171-1173
Supporto sternale per tutti gli apribocca	546	TRAUBE Martelli percussori	693
Supporto valve atriali	617	TRAUTMANN Scalpelli	17
SWEDISH Dissettori per la dura-madre	820	TRAUTMANN Sgorbie	1029
SWEET Pinze per applicare le agrafe	550	TRAVERS Divaricatori, autostatici	1029
SYPERT Pinze per laminectomia	547	Trefine cutanee	456
SYPERT Pinze per laminectomia	985	TRELAT Periostotomi	60, 61
SYPERT Pinze per ossa	987	TRELAT Speculi vaginali	1053
SYSTRUNK Forbici per unghie	1140	Trequarti	882
<b>T</b>	1204	Trequarti per empiema	69-71
TABB Bisturi per mucosa		Trequarti per puntura del seno mascellare	70
Taglia cranio	745	Trequarti per sinusopia	69, 70, 87
TAKAHASHI Pinze nasali	1021	Trequarti per vescia biliare	692
TAKAHASHI Pinze per laminectomia	757	Trequarto per tracheotomia	71
Tamburo rumoroso	994	TREVES Pinze per chirurgia	653
TARNIER Cranioclasto	716	TROELTSCH Pinze auricolari e nasali	216
TARNIER Pinza obsterica	938	TROELTSCH-JALASVIRTA Pinze auricolari e nasali	221
TAYLOR Martelli percussori	935	TROEMMER Martelli percussori	221
TAYLOR Pinze anatomiche per dissezione	16	Tronchesini per unghie	16
TAYLOR Pinze per chirurgia	200, 201	TROUSSEAU Dilatatori per tracheotomia	1205, 1206
TAYLOR Retrattori per ginocchio	212, 213	TROUTMAN-CHRIS Pinze per afferrare	654
TAYLOR Valve laterale	1148	TROUTMAN-CHRIS Pinze per rompere le lamette de rasoio	47
TAYLOR-BROWN Pinze per chirurgia	558	TUBBS Dilatatori per aorta	47
TC Forbici da uteroa	216	Tubi aspirazione	810
TC Forbici fine per chirurgia	163, 164	Tubo di intubazione	77-89
TC Forbici nasali	177, 178	Tubo per aspirazione coagulazione,	653
TC Forbici per chirurgia	174	TUEBINGEN Divaricatori	87
TC Forbici per dissezione	162, 165, 167	TUEBINGEN Divaricatori, autostatici	414
TC Forbici per episiotomia	167-173	TUEBINGEN Micro-forbici	449
TC Forbici per Face-lift	162	TUEBINGEN Micro-pinze	140
TC Forbici per gengiva	175, 176	TUEBINGEN Pinze per calcoli biliari	227
TC Forbici per ginecologia	177, 178	TUFFIER Divaricatori	878
TC Forbici per isterectomia	162	TUFFIER Divaricatori costali	403
TC Forbici per legature	166	TUFFIER Pinze da presa per intestino e tessuti	780
TC Forbici per perineo	181	TURNBULL Tronchesini per unghie	365
TC Forbici per tonsille	162	TYDING Serranodi per tonsille	1205
TC Forbici taglia cavo	174	TYDING-TIVNEN Pinze per tonsille	624
TC Forbici vascolari	180	<b>U</b>	621
TC Pinze per sutura	179, 180	UCKERMANN Portacotone	
TEALE Pinze per abbassare il collo dell'utero	236	UCKERMANN Trequarto per tracheotomia	65
Telaio per sterilizzare aghi per sutura	904	UFFENORDE Curette per ossa	653
Tenaglie per ossa	1223	ULM Baule di emergenza	1114
Tenaglie per ossa	1117-1125	ULRICH Bisturi per fistole	28
Tenaglie tagliafilii	1126	ULRICH Pinze per tamponi	56
TERRIER Pinze emostatiche	1164-1170	ULRICH Tenaglie per ossa	349
TESSIER Forbici nasali	259	Uncini	1122
TESSIER Osteotomi	120	Uncini auricolari	706, 708, 747, 748, 750, 752, 753, 831, 832, 841
TESSIER Periostotomi	1033, 1036, 1037	Uncini per dura-madre	730, 731
TESSIER Pinza per formare osso	1058	Uncini tracheali	554, 555
THILENIUS Pinze per accessi tonsillari	1118	Uncino delicato	655
THOMS-ALLIS Pinze da presa per intestino e tessuti	623	Uncino nasale ad anello	830
THOMS-GAYLOR Pinze per la biopsia cervicale e da prelievo	364	Uncino per ali nasali	689
THOMSON-WALKER Divaricatori vescicali	919	Uncino per seno mascellare	688, 689
THOREK Forbici per dissezione	952	Uncino per staffa	747
THOREK TC Forbici per dissezione	113	Unici per esplorazione e coagulazione	747
THUDICHUM Speculi nasali	171	Uncini pere nervi e vasi	834
TIECK-HALLE Speculi nasali	660	Unico per detroncazione	822, 829
TILLEY Pinze per tamponi e polipi nasali	660, 661	UNIVERSAL Forbici per bendaggi e gessi	937
TILLEY-HENCKEL Pinze nasali	669	UNIVERSAL Forbici taglia cavo	1191
Tiracomedoni	989	UNIVERSAL Pinze per strumenti sterilizzati	148
TISCHLER Pinze per la biopsia cervicale e da prelievo	61	UNIVERSAL TC Forbici taglia cavo	1209
TISCHLER-KEVORKIAN Pinze per la biopsia cervicale e da prelievo	917, 921	UNIVERSAL Trequarti	180
TISCHLER-MORGAN Pinze per la biopsia cervicale e da prelievo	921	UNNA Tiracomedoni	69
TOBOLD Abassalingua	921, 922	UNNA-VIDAL Tiracomedoni	61
TOBOLD Pinze per polipi laringei	601	Uretrotomo	61
TOENNIS Coltello per dura-madre	634	Urinale	954
TOENNIS Forbici per dissezione	57, 58	USA Apri gesso	1216
TOENNIS Pinze emostatiche	114	USA Curette per ossa	1194
TOENNIS Portaghi	243, 255	USA Forbici ombelicali	1108, 1109
TOENNIS Spatola per intima	497	USA Pinze anatomiche per dissezione	102
TOENNIS TC Portaghi	814	USA Pinze per chirurgia	196
TOENNIS Uncini per dura-madre	531	<b>V</b>	206
TOENNIS-ADSON Forbici per dissezione	555	VALLEIX Isterometri	

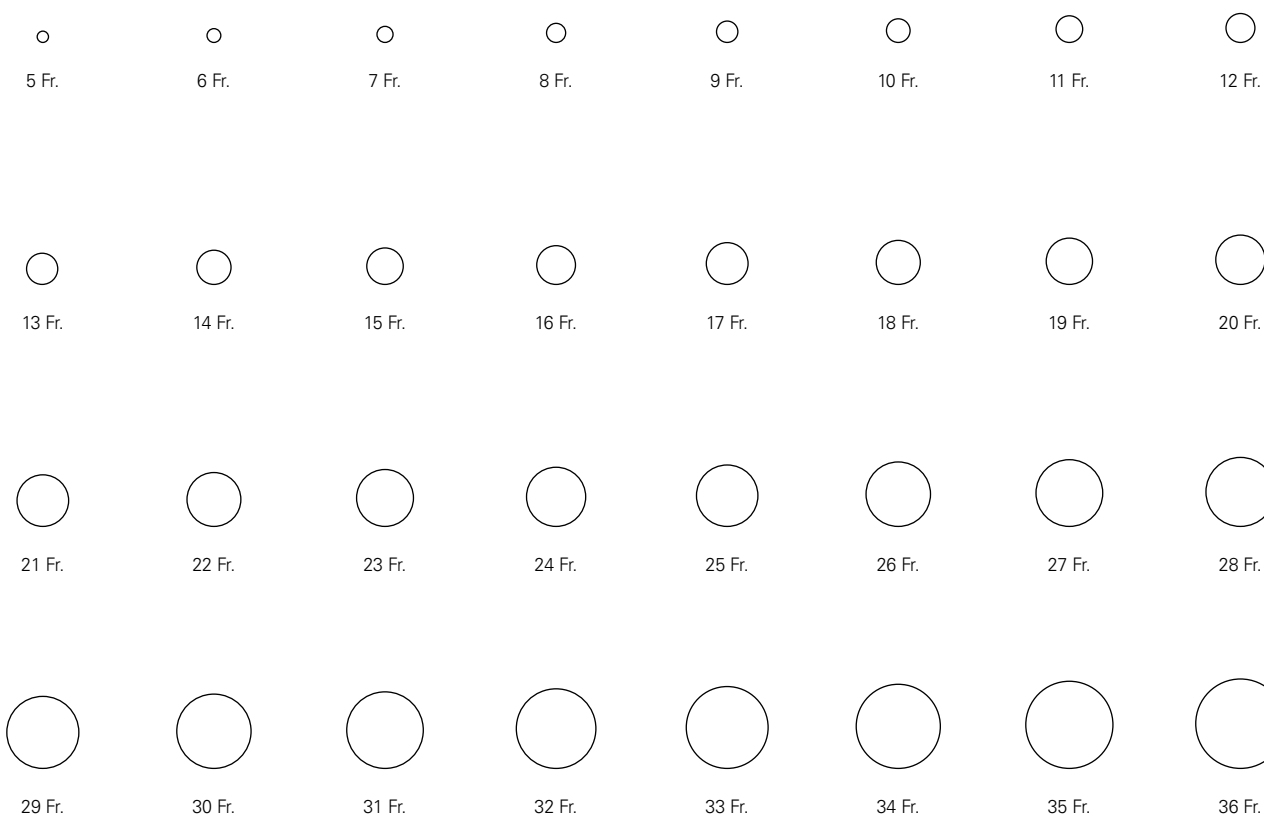
Valve atriali	899	WERTHEIM Pinze per anastomosi del retto	100
VAN BUREN Candelette dilatatrici	820	WERTHEIM Pinze per isterectomia	859
VAN BUREN Pinze per frammento osseo	950	WERTHEIM TC Forbici per isterectomia	271, 272
VAN DOREN Pinze per la biopsia cervicale e da prelievo	1118	WERTHEIM-CULLEN Pinze per isterectomia	166
VANNAS Micro-forbici	918, 919	WEST Scalpelli	276
VARADY Flebo-dissetto	140	WEST Sgorbie	1025
VARADY Flebo-estrattore	814	WESTCOTT Micro-forbici	1025
VARADY Micro-dissetto	814	WESTMACOTT Pinze per tamponi e polipi nasali	141
VARADY Set di sonde per varici	814	WHITE Pinze per tonsille	669
VASCULAR Portaghi	807	WHITEHEAD Apribocca	620
VEDDER Serranodi per tonsille	498	WIEDER Abassalingua	604
VEIDENHEIMER Pinze per anastomosi del retto	624	WIEN Speculi nasali	602
Vena-compresión	857	WIEN MOD. Pinze per isterectomia	662
VERBRUGGE Tenaglie per ossa	29	WIEN Trapano per seno mascellare	274
VERHOEVEN Tubi aspirazione	1124	WIGMORE Coltelli per gessi	693
VERRES Cannula per insufflazione	89	WIKSTROEM Pinze per preparazioni e legature	1195
VICKERS Dissettori	73	WILDER Stilette per canale lacrimale	269
VICKERS Divaricatore per dita	1052	WILLET Pinza per il cuoio cappelluto	63
VICKERS Divaricatori	1183	WILLET-MARTEL Pinze da presa per intestino e tessuti	936
VICKERS Elevatori	428, 1183	WILLIAMS Divaricatori, autostatici	366
VICKERS Fissatore per mano	1052	WILLIAMS Pinze da presa per intestino e tessuti	464
VICKERS Perforatori a mano	1182	WILLIGER Curette per ossa	360
VIDAL Raschiatoio per lupus	1156	WILLIGER Divaricatori	1094, 1096
VIENNA Portalegature	60	WILLIGER Elevatori	420
Vigorimeter	513	WILLIGER Martelli	1074
VIRCHOW Coltelli per autopsie	21	WILLIGER Periostotomi	1016
VIRCHOW Coltelli per cervello	54	WILMER-WALTER Forbici nasali	1053
VIRCHOW Taglia cranio	55	WILSON Pinze per abbassare il collo dell'utero	122
VOLKMANN Curette per ossa	1021	WINTER Pinze per placenta e per ovaie	904
VOLKMANN Divaricatori	1092, 1096, 1104, 1105	WIS-FOREGGER Laringoscopi	939, 940
VOLLMAR Cannula per irrigazione vascolare	374, 378	WITTNER Pinze per la biopsia cervicale e da prelievo	39
VOLLMAR Stripper anello	73	WOLFF Apri gesso	920
VOLTOLINI Speculi nasali	808	WOLFF Curette per lupus	1194
<b>W</b>	660	WOODSON Dissettori per la dura-madre	60
WACHENFELDT Pinze per applicare le agrafe		WRIGLEY Pinza obsterica	812
WAGENER Divaricatori	517	WUERZBURG Abassalingua	935
WAGNER Forbici fine per chirurgia	429	WULLSTEIN Divaricatori, autostatici	616
WAGNER Leve per ossa	125, 126	WULLSTEIN Manico per aspirazione	447
WAGNER Martelli	1076, 1080, 1081	WULLSTEIN Micropinze con morsi a cucchiaino	85
WAGNER Periostotomi	1014	WULLSTEIN Periostotomi	739
WAGNER Pinze per laminectomia	1070	WULLSTEIN Tubi aspirazione	1054
WAGNER Sgorbie	985, 986	<b>Y</b>	77, 86
WAGNER Strumenti curvi	1049	YANKAUER Tubi aspirazione	
WAGNER TC Forbici fine per chirurgia	1170	YASARGIL Bisturi per vasi	81, 82
WALB Coltelli per autopsia	177	YASARGIL Dissetto	838
WALDMANN Forbici per episiotomia	55	YASARGIL Ganci galea	835
WALDMANN Forbici per perineo	101, 152	YASARGIL Guida per legatura	545
WALDMANN TC Forbici per episiotomia	101, 152	YASARGIL Periostotomo	829
WALDMANN TC Forbici per perineo	162	YASARGIL Pinze per laminectomia	835
WALLICH Cucchiaini uterine	162	YASARGIL Tubi aspirazione	1005
WALTER Osteotomi	911	YASARGIL-NICOLA Micropinze da presa	80
WALTER Scalpelli	682	YEOMANN Pinze per biopsia rettale	651
WALTER Sgorbie	682	YOUNG Pinze da presa per lingua	869
WALTER Uncino per ali nasali	1033	YOUNG Retrattori prostatici	618
WALTON Pinze per biopsia rettale	688	YOUNG-HRYNTSCHAK Aghi per legatura	953
WALTON Seghe per aprire anelli	869	<b>Z</b>	513
WALTON-YANKAUER Tubi aspirazione	1011	ZANDER Puteruoli	
WANGENSTEEN Pinze per afferrare tessuti	81	ZAUFAL Leva auricolare	1012
WANGENSTEEN Portaghi	204	ZAUFAL-JANSEN Pinze per ossa	730
WANGENSTEEN TC Pinze anatomiche per dissezione	494	ZAUFAL-JANSEN Uncini auricolari	1133
WANGENSTEEN TC Portaghi	233	ZENKER Divaricatori	731
WARTENBERG Algesiometro	527	ZENKER Pinze per preparazioni e legature	391
WARTENBERG Rotella neurologica	20	ZIEGLER Coltello per dura-madre	262, 263
WASSMUND Divaricatori	20	ZIEGLER Pinze per ciglia	57
WATSON Dermotomi	380	ZIEGLER Specchio frontale	223
WATSON-CHEYNE Dissettori	59	ZIELKE Sgorbie	35
WATSON-JONES Leve per ossa	1056	ZOELLNER Bisturi falciforme	1044
WATSON-WILLIAMS Pinze nasali	1076	ZOELLNER Bisturi lanceolato	752
WAUGH Pinze per chirurgia	993, 994	ZOELLNER Bisturi rotondi	752
WEBER Estesiometro	206	ZOELLNER Forcella di guida	752
WEBER Pinze vascolari atraumatiche	20	ZOELLNER Microaghi	752
WEBER-LOCH Anse auricolari	312	ZOELLNER Periostotomo	752
WEBSTER Portaghi	729, 730	ZOELLNER Specchi auricolari	752
WEBSTER TC Portaghi	491	ZOELLNER Tubi aspirazione	720
WECKER Micro-forbici	525	ZOELLNER Uncino	89
WEIL-BLAKESLEY Pinze nasali	139	Z-PARAMETRIUM Pinze per isterectomia	752
WEIL-BLAKESLEY Pinze per etmoide	988, 989		286
WEISMAN Curette auricolari	745		
WEISSBARTH Speculi vaginali	729		
WEITLANER Divaricatori, autostatici	895		
WEITLANER-BABY Divaricatori, autostatici	446, 447, 453, 454		
WELLER Pinze da presa per menisco e cartilagine	449		
WERTHEIM Forbici da utero	1145		



Milimeter | Milimeter | Milímetro | Milimetro

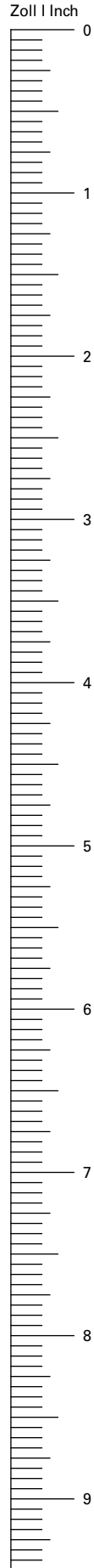
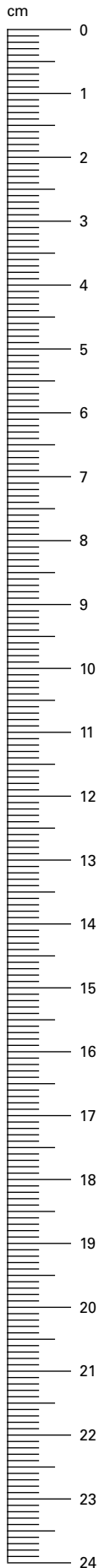


French | Charrière



French | Charrière

5 Fr.	1,7 mm	21 Fr.	7,0 mm
6 Fr.	2,0 mm	22 Fr.	7,3 mm
7 Fr.	2,3 mm	23 Fr.	7,7 mm
8 Fr.	2,7 mm	24 Fr.	8,0 mm
9 Fr.	3,0 mm	25 Fr.	8,3 mm
10 Fr.	3,3 mm	26 Fr.	8,7 mm
11 Fr.	3,7 mm	27 Fr.	9,0 mm
12 Fr.	4,0 mm	28 Fr.	9,3 mm
13 Fr.	4,3 mm	29 Fr.	9,7 mm
14 Fr.	4,7 mm	30 Fr.	10,0 mm
15 Fr.	5,0 mm	31 Fr.	10,3 mm
16 Fr.	5,3 mm	32 Fr.	10,7 mm
17 Fr.	5,7 mm	33 Fr.	11,0 mm
18 Fr.	6,0 mm	34 Fr.	11,3 mm
19 Fr.	6,3 mm	35 Fr.	11,7 mm
20 Fr.	6,7 mm	36 Fr.	12,0 mm



Zoll   Inch	mm
1"	25,4 mm
1 1/4"	31,7 mm
1 1/2"	38,1 mm
1 3/4"	44,5 mm
2"	50,8 mm
2 1/4"	57,1 mm
2 1/2"	63,5 mm
2 3/4"	69,8 mm
3"	76,2 mm
3 1/4"	82,5 mm
3 1/2"	88,9 mm
3 3/4"	95,2 mm
4"	101,6 mm
4 1/4"	107,9 mm
4 1/2"	114,3 mm
4 3/4"	120,6 mm
5"	127,0 mm
5 1/4"	133,3 mm
5 1/2"	139,7 mm
5 3/4"	146,0 mm
6"	152,4 mm
6 1/4"	158,7 mm
6 1/2"	165,1 mm
6 3/4"	171,4 mm
7"	177,8 mm
7 1/4"	184,1 mm
7 1/2"	190,5 mm
7 3/4"	196,8 mm
8"	203,2 mm
8 1/4"	209,5 mm
8 1/2"	215,9 mm
8 3/4"	222,2 mm
9"	228,6 mm
9 1/4"	234,9 mm
9 1/2"	241,3 mm
9 3/4"	247,6 mm
10"	254,0 mm
10 1/4"	260,3 mm
10 1/2"	266,7 mm
10 3/4"	273,0 mm
11"	279,4 mm
11 1/4"	285,7 mm
11 1/2"	292,1 mm
11 3/4"	298,4 mm
12"	304,8 mm
12 1/4"	311,2 mm
12 1/2"	317,5 mm
12 3/4"	323,9 mm







AMNOTEC International Medical GmbH  
take-off GewerbePark 11  
78579 Neuhausen ob Eck | Germany

+49 7467 422970  
info@amnotec.de  
www.amnotec.de

